

MOULDING CATALOG



SPRING 2019

distributors of
**QUALITY MOULDINGS
& ACCESSORIES**

WWW.GARDENSTATELUMBER.COM

CONTENTS

Mouldings	4-132	NuCedar PVC Sheet Stock	149
Metro Collection Mouldings	71-110	NuCedar PVC Mouldings	150-153
Designer Collection Mouldings	111-125	Prefinished Color PVC Trim	154-155
Door Jambs	126	NuCedar Shingles and Siding	156-165
Hardwood Collection Mouldings	127-133	Melamine Sheets & Shelving	166
Custom Arches & Architectural Accents	134-135	S4S Products	167-169
Nantucket Beadboard	136-146	Sheet & Panel Products	170-171
NuCedar PVC Trimboards	148		

MOULDING CONTENTS

1/2" x S4S	64	Dentil Mouldings	51	Parting Strip	64
Architectural Accents	32	Door Jambs – Interior	126	Picture Frame	64
Astragals & Mullion Centers	63	Door Sills	69	Picture Mouldings	64
Back Bands	17	Drip Caps	66	Pilasters	17
Balusters	63	Edge & Center Bead Cap	62	Plinth Blocks	31
Band / Rake Mouldings	63	Edge & Center Beads	61	Poles	67
Bar Rail	67	Extension Jambs	68	Porch Rail	67
Base Cap/Panel	54-60	Flat Bottom Rail	67	Quarter Rounds	67
Bases	5-16	Floor Mouldings	5	Rope	51
Base Shoe	5	Glass Beads	64	Rosettes	32
Beaded Edge	64	Half Rounds	67	Sanitary Caps	66
Bed Mouldings	49	Hand Rail	67	Sanitary Corner Guards	66
Brick Moulding	19	Inside Corner	49	Sanitary Edge	64
Bullnose	65, 69	Landing Treads	70	Screen Moulding	64
Casings	14-30	Lattices	64	Shiplap	61
Cedar Closet Lining	70	Mantel	70	Skew Backs	64
Chair Rails	52-53	Melamine Sheets & Shelving	166	Stepping	66
Colonial Corner Guards	66	Neck Mouldings	50	Stool	68-69
Cove Mouldings	49	Nose & Coves	57	Stops	65
Coves – Beaded	49	Oak Hearth Border	70	Wainscoat Caps	62
Crown Backer	35	Oak Nosing	70	Wainscoating	61
Crowns/Coves	33-48	Oak Saddles	70	Window Sills	69
Crowns – Solid	50	Oval Hand Rail	67	Yellow Pine T&G Flooring	66
Dentil Crowns	51	Panel Mouldings	56-57		

MOULDING PROFILES

138BBPVC	17	8746	18	D8090	65	GS400	22	M8753	63	PLC1012	48	WM81	49
693	5	8753	18	D8121	65	GS419	25	MCAP1	58, 83	PLP312	57	WM85	49
1268B	68	8900	63	DC400	23, 113	GS425	23	MCAP2	58, 83	PLR334	53	WM93	49
1274	68	8901	63	DC412	25, 113	GS434	26	MCAP34	58, 83	PM2200	21	WM97	19
8013	34	8902	63	DC450	26, 113	GS441	24	MCAP54	58, 83	PWS612	69	WM130	63
8016	49	8904	63	DC499	28, 114	GS694	21	MCB5	7, 80	PWS634	69	WM133	63
8017	49	8908	67	DC512	29, 115	GSB412	6	MCB7	10, 80	RAB297	62	WM163	54
8018	49	8926	66	DC550	29, 115	GSB512	9	MCB512	15, 80	RAKEPVC	151	WM164	54
8024	49	8938	68	DCAS5 29, 53, 115, 120		GSB534	9	MCB525	8, 79	RAMPVC	151	WM180	19
8026	49	A8090	65	DCB8	12, 118	GSB725	11	MCB712	15, 80	RC214	17	WM197	66
8027	34	A8121	65	DCB525	8, 116	GSC412	36	MCB725	11, 79	RP12	51	WM206	66
8047	50	A8173	63	DCB534	9, 116	GSC512	40	MCBB1	17, 76	RP34	51	WM209	50
8052	49	A8926	66	DCB714	11, 116	GSC614	41	MCBB2	17, 76	S2	66	WM210	50
8054	49	B34	54	DCB775	12, 118	GSC738	45	MCC212	15, 76	S4	64	WM212	63
8057	67	B608	54	DCB825	13, 118	HB158	70	MCC312	15, 76	S5	69	WM217	63
8058	67	B658	54	DCB925	13, 118	JC412	24	MCC334	21, 72	S7	49	WM230	67
8060	49	B665	54	DCBB5	9, 116	L239	63	MCC375	21, 74	S8	67	WM231	67
8061	49	B662	50	DCLK5	28, 114	L265	64	MCC412	15, 76	S9	49	WM265	64
8062	49	B672	64	DCR512	39, 122	L623	6	MCC434	27, 72	S12	68	WM281	17
8063	67	B8090	65	DCR558	40, 122	L634	6	MCC475	27, 74	S16	68	WM290	66
8064	67	B8121	65	DCR612	42, 123	L723	5	MCC534	30, 72	S18	68	WM315	19
8065	67	B8173	63	DCR634	43, 123	L724	5	MCC575	30, 74	S20	68	WM327	19
8066	67	B8712	6	DCR725	45, 124	L953	65	MCOV5	36, 88	S21	68	WM351	18
8068	67	B8712N	6	DCR734	47, 124	L995	64	MCOV6	38, 88	S30	68	WM356	18
8070	67	B8746	18	DCR814	47, 125	L1021	69	MCOV8	44, 88	S31	68	WM361	18
8071	67	B8753	18	DCWC5	27, 114	L1084	68	MCR514	38, 90	S86	49	WM376	18
8072	67	BB6	9	DTL112	51	L8009	34	MCR550	39, 92	SAD4	70	WM390	52
8073	67	BB7	10	DTL158	51	L8010	34	MCR650	42, 92	SAD5	70	WM412	16, 84
8076	67	BB138	54	DTL334	51	L8013	34	MCR714	44, 90	SAD6	70	WM444	18
8077	67	BB414	6	DTL512	51	L8027PVC	34	MCR750	46, 92	SAD431	70	WM445	18
8080	67	BB458	7	E2E432	16, 84	L8065	67	MCS1	5, 58, 80, 83	SAD531	70	WM452	16, 84
8121	65	BB514	7	E693	5	L8080	67	MSC175	50, 83, 86	SAD631	70	WM472	16, 84
8144	65	BB514N	7	E8090	65	L8200	66	MSC225	50, 86	SAN414	16, 85	WM418	7
8180	63	BB518	8	ECB4	61	L8202	66	MSC275	50, 86	SAN525	16, 85	WM620	6
8186	52	BB714	10	ECB6	61	L8269	68	N138	70	SAN725	16, 85	WM624	6
8187	52	BB738	11	ECB55PVC	61	L8279	64	N8753	18	SBC514	37	WM662	6
8200	66	BBCAP12	17, 62	ECBCAP	17, 62	L8282	64	NB514	7	SC134	50	WM714	5
8201	66	BC5	37	ES1	20	L8288	64	NY102	64	SC214	50	WM750	14
8202	66	BC78	54	ES2	20	L8422	5	NY109	63	SC234	50	WM753	14
8268	68	BDB25	14	ES3	25	L8423	5	NY127	50	SH1	5	WM875	65
8279	64	BDB35	14	ES4	23	L8535	50	NY128	50	SHIP4	61	WM876	65
8280	64	BDB45	14	ES5	53	L8712	6	NY212	63	SHIP6	61	WM887	65
8281	64	BDB55	14	ES6	53	L8746	18	OS12	66	SHIP8	61	WM888	65
8282	64	BNS18	69	ES7	53	L8753	18	P214	67	SHIP10	61	WM935	65
8288	64	BS134	56	ES8	53	L8938	68	P329	67	SILL7117PVC	153	WM936	65
8313	17	C103	19	ES9	55	L8940	69	P514	17	SILL7118	153	WM938	65
8409	55	C105	19	ES10	70	LF8834	67	P714	17	SILL7435PVC	153	WM1021	69
8412	55	C106	19	ES11	56	LF8835	67	PB418	31	SILL7650	153	WM1300	63
8416	55	C8090	65	ES12	24	LK3	20	PB518	31	SILLCT	69	WM1305	63
8417	55	C8121	65	ES13	17	LK4	22	PB550	31	SILLNV	69	WP101	49
8422	5	C8712	6	ES14	17	LS6	69	PL2	56	SL6	61	WP140	64
8423	5	C8753	18	ES15	56	LT312	70	PL78	54	SL8	61	WP210	50
8427	5	CB312	35	ES16	17	LWM47	34	PL118	54	STF1	18	WP211	50
8432	64	CB544PVC	153	F8	67	LWM49	34	PL134	56	TW2	68	WP830	65
8462	63	CB546PVC	153	F233	67	LWM70	49	PL138	54	TW4	68	WP831	65
8463	63	CCL32	70	F693	5	LWM135	63	PL378	22	TWEJ	68	WP845	65
8469	63	CGM31	19	F1021	69	LWM204	66	PL458	26	UC31	35	WP855	65
8470	63	CHIBAR	67	F8282	64	LWM264	64	PL514 .					

WHERE MOULDINGS GO

ALL PROFILES SHOWN BELOW ARE FROM OUR NEW METRO COLLECTION OF TIMELESSLY MODERN MOULDINGS.



Crown - MCR514, MCC312, Coffered Ceiling - MCR514, MCC312, 1x6, Modern Casing Head - San414, MSCOV5, 1x8, MSC175, WM887

Casing Leg - MCC412, MCB2, Wall Paneling - 8121, MSC225, 1x6, MCAP1, 1x12, Base - MCB712, MCS1

Sill & Stool - MSC175, LS6, Chair Rail/Panel Cap - MSC225, 8121

BASE SHOE

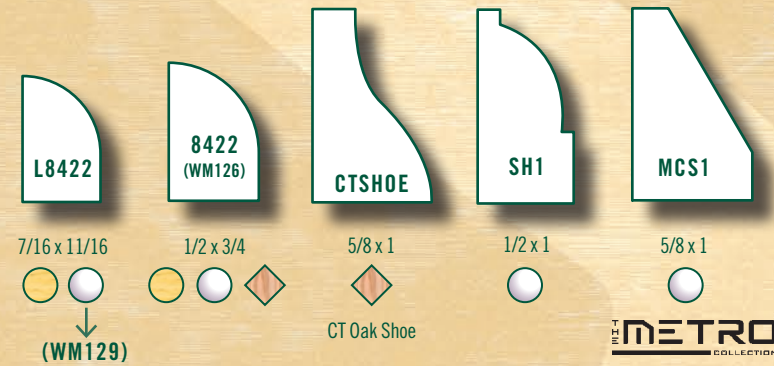

MCS1 Shoe used as cap, 1" x 6", MCS1 Shoe Moulding

FLOOR MOULDINGS

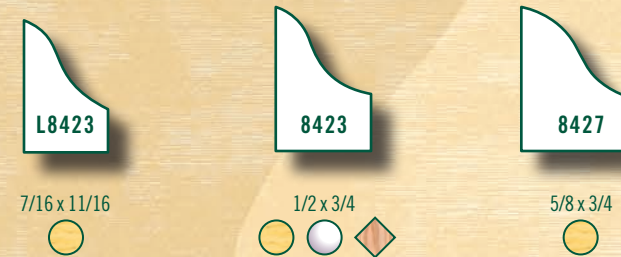

GSB534 Base with SH1 Shoe Moulding

BASES - CLAM SHELL



All profiles are available in select hardwood species on a special order basis (see pages 127-133 for our hardwood moulding programs)

● PINE
 ● PRIMED
 ◆ OAK
 ▲ ULTRALITE MDF
 ▼ PRIMED POPLAR
 ▼ POPLAR
 ● PVC

BASES - COLONIAL

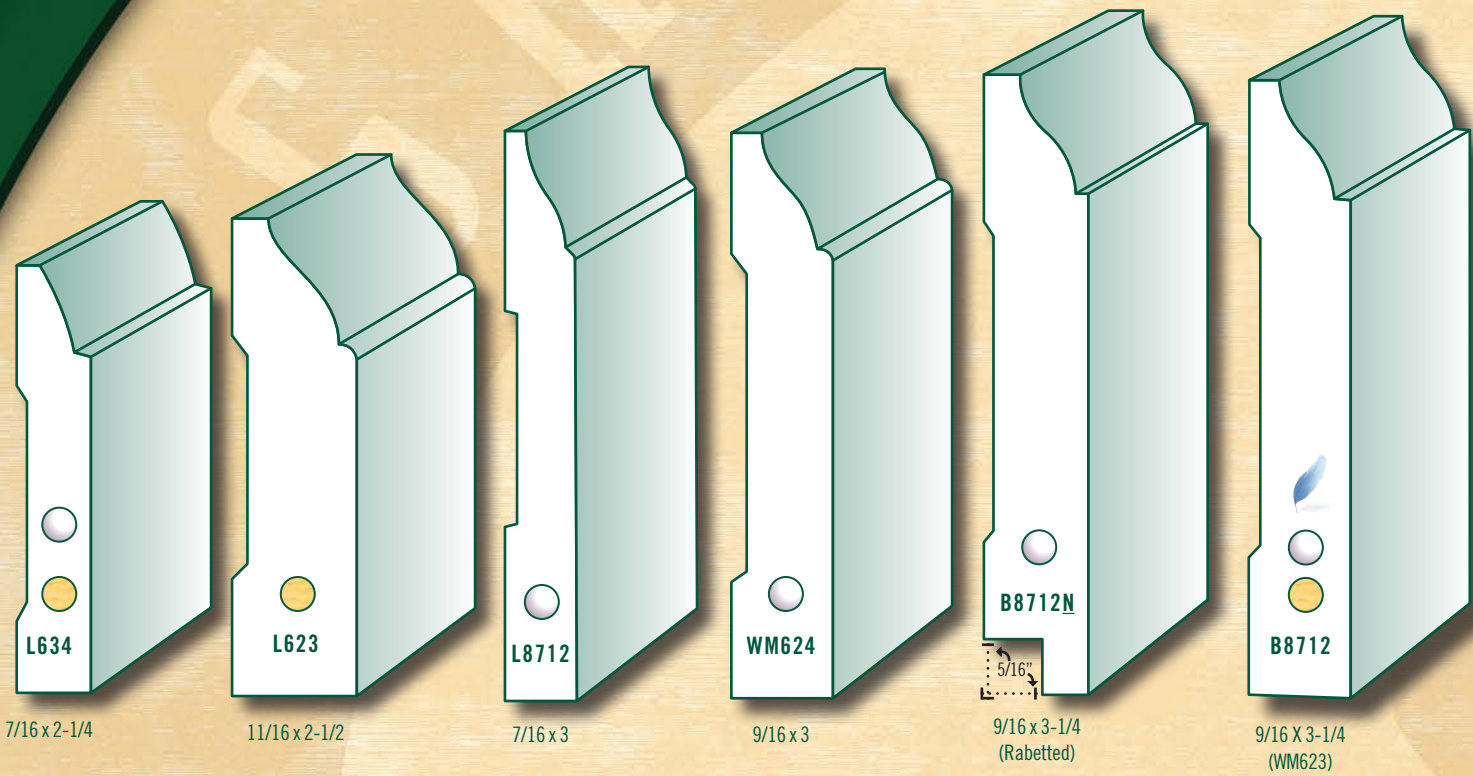

GSB412



BB458 & 8423



MCB5

BASES

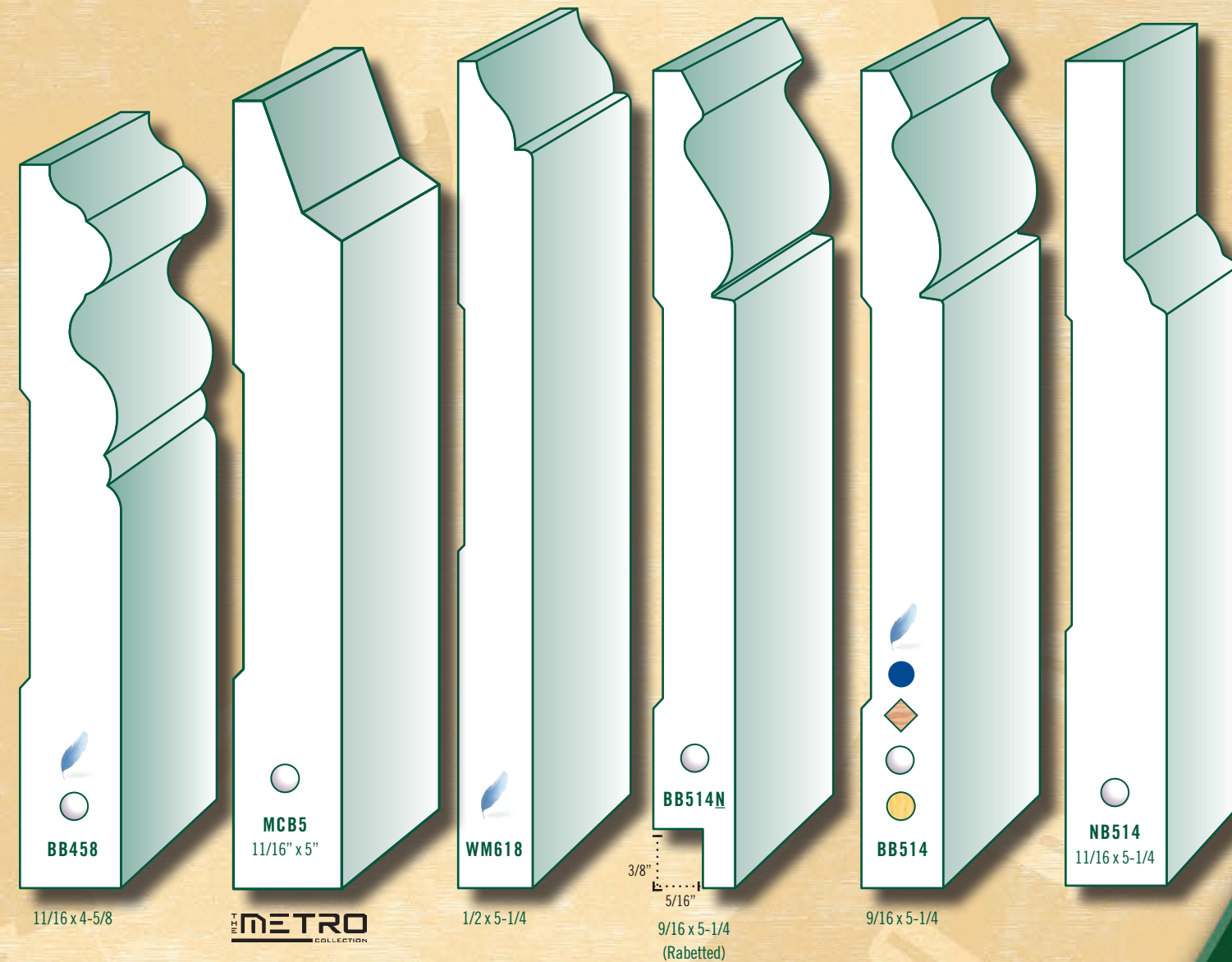
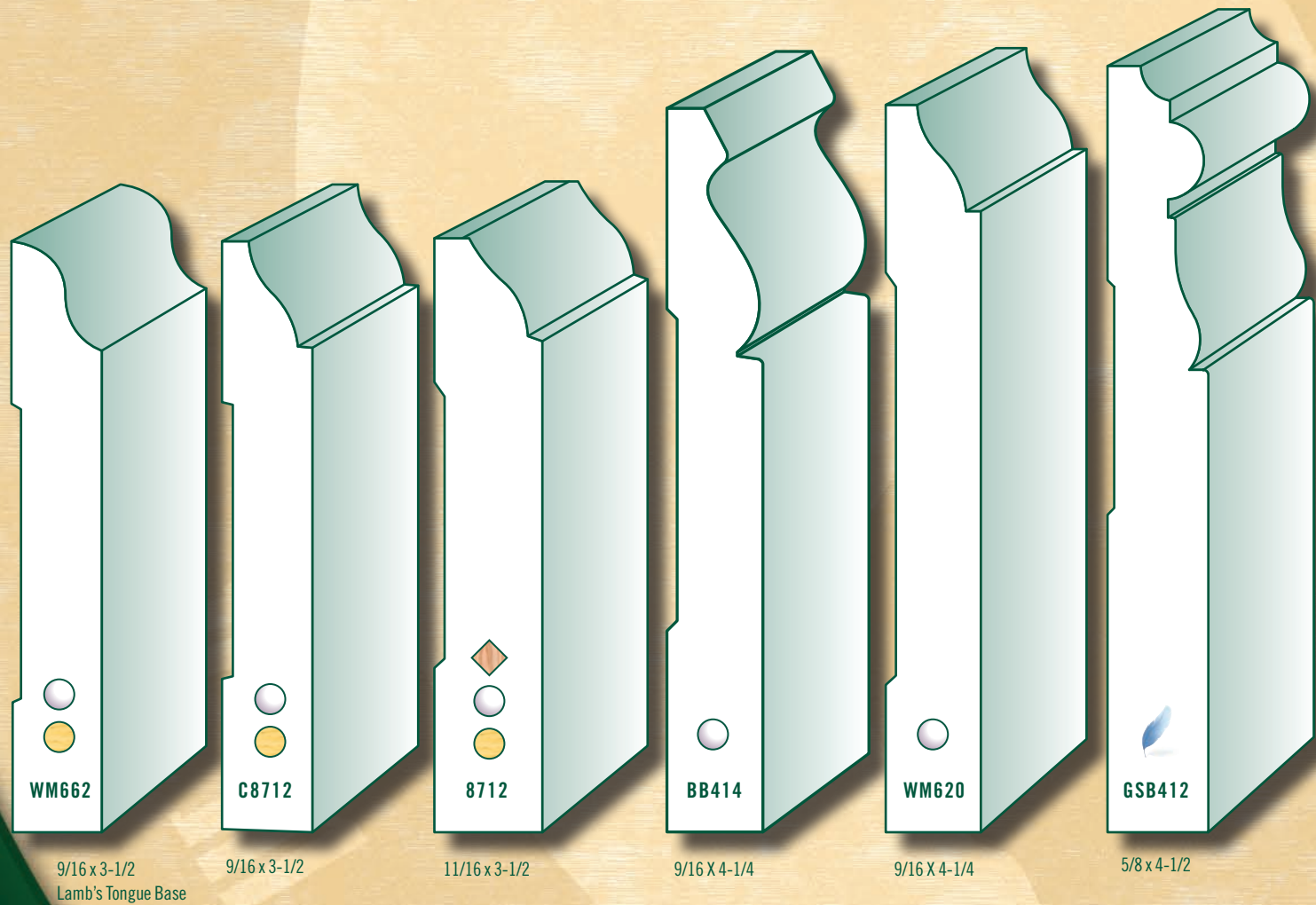

All profiles are available in select hardwood species on a special order basis (see pages 127-133 for our hardwood moulding programs)

● PINE
 ● PRIMED
 ◆ OAK
 ● ULTRALITE MDF
 ▽ PRIMED POPLAR
 ▽ POPLAR
 ● PVC

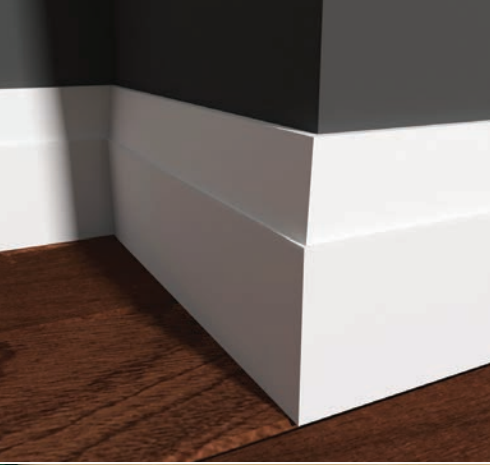

MCB525



DCB525



GSB512 & SH1



DCBB5



GSB534



DCB534

BASES

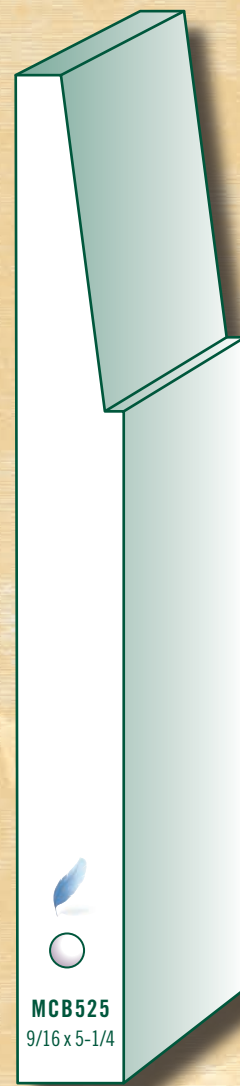

MCB525
9/16 x 5-1/4

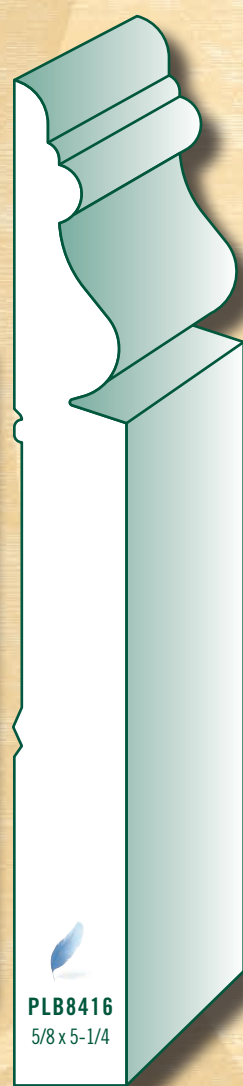

PLB8416
5/8 x 5-1/4

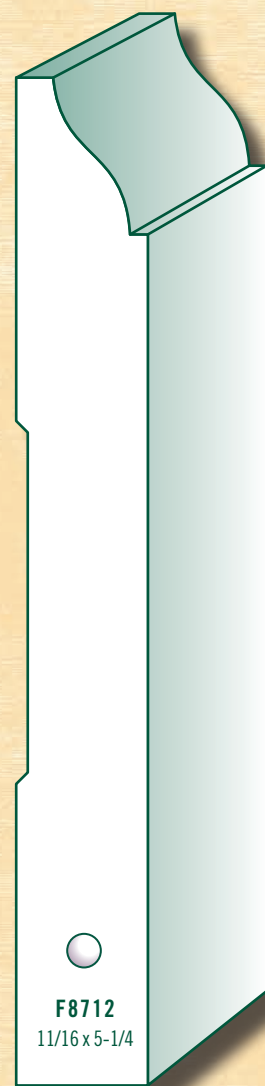

F8712
11/16 x 5-1/4

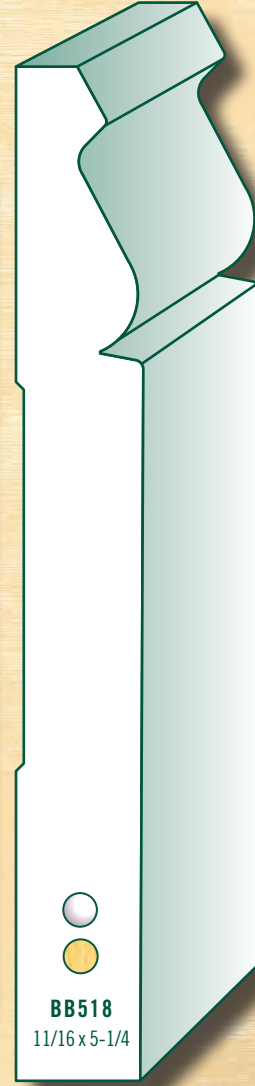

BB518
11/16 x 5-1/4



DCB525
13/16 x 5-1/4
18' Lengths

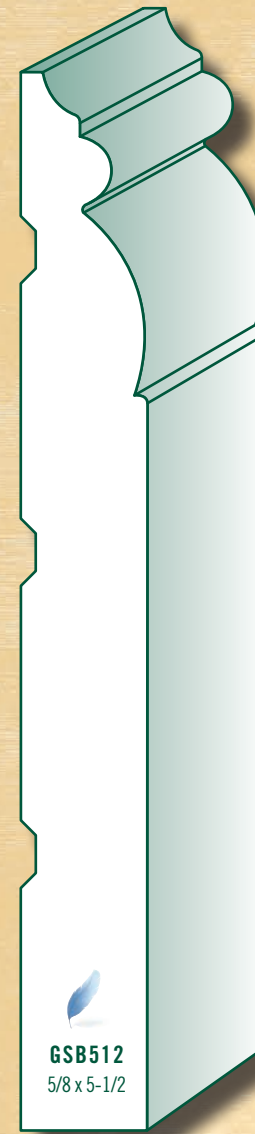

GSB512
5/8 x 5-1/2

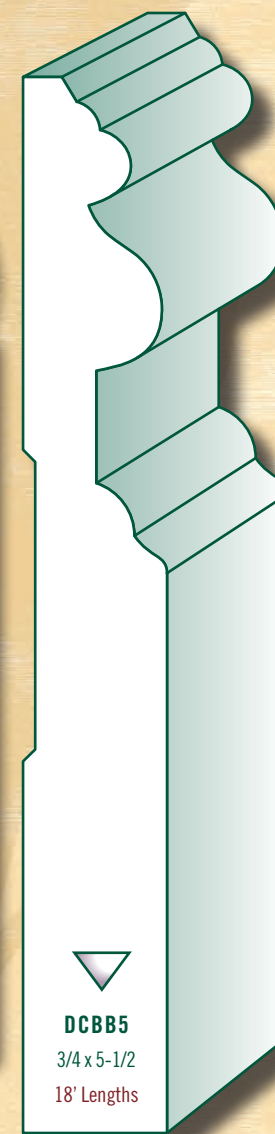

DCBB5
3/4 x 5-1/2
18' Lengths

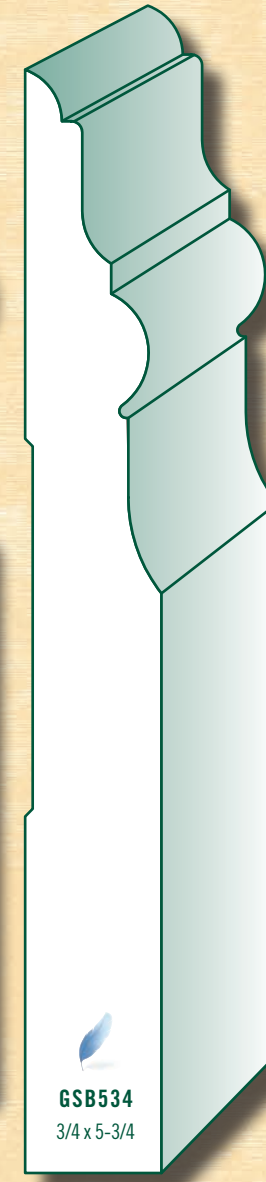

GSB534
3/4 x 5-3/4

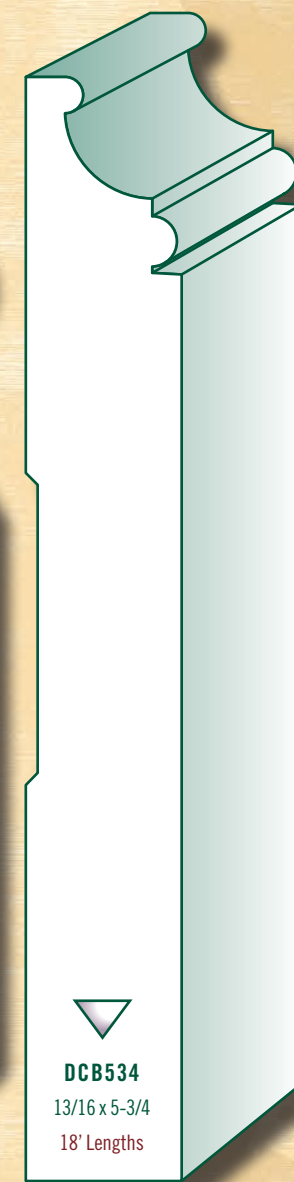

DCB534
13/16 x 5-3/4
18' Lengths

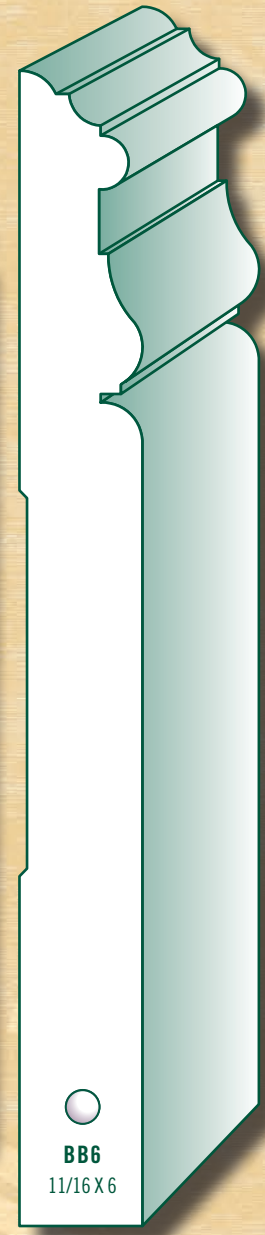

BB6
11/16 X 6

BASES

METRO
COLLECTION

The
DESIGNER
COLLECTION

The
DESIGNER
COLLECTION

The
DESIGNER
COLLECTION

All profiles are available in select hardwood species on a special order basis (see pages 127-133 for our hardwood moulding programs)

● PINE ● PRIMED ● OAK ● ULTRALITE MDF ● PRIMED POPLAR ● POPLAR ● PVC



PLB612 & 8422

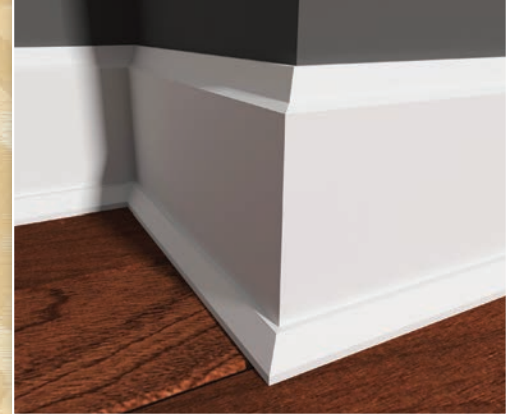

MCB7 Base, MCS1 Shoe

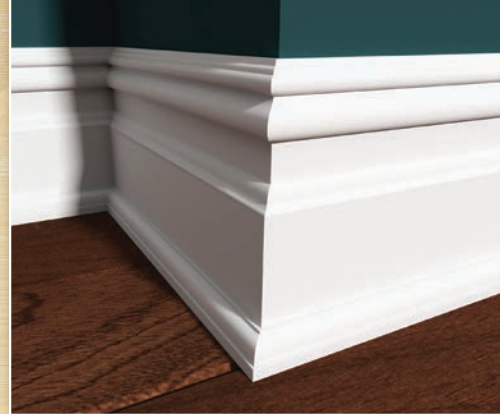

BB7 & SH1

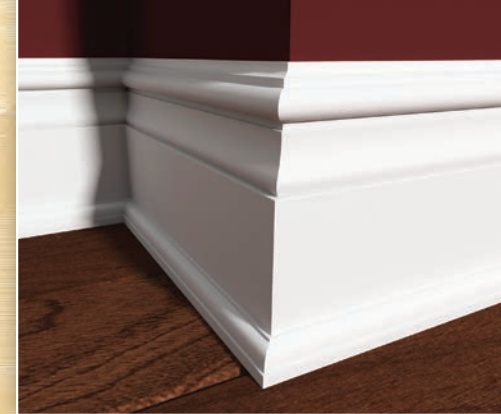

GSB725 & SH1



MCB725 & MCS1

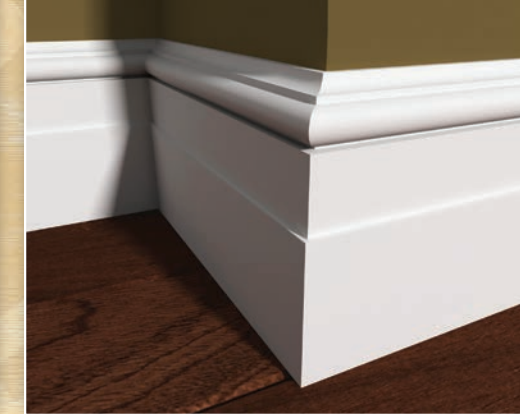

DCB714

BASES

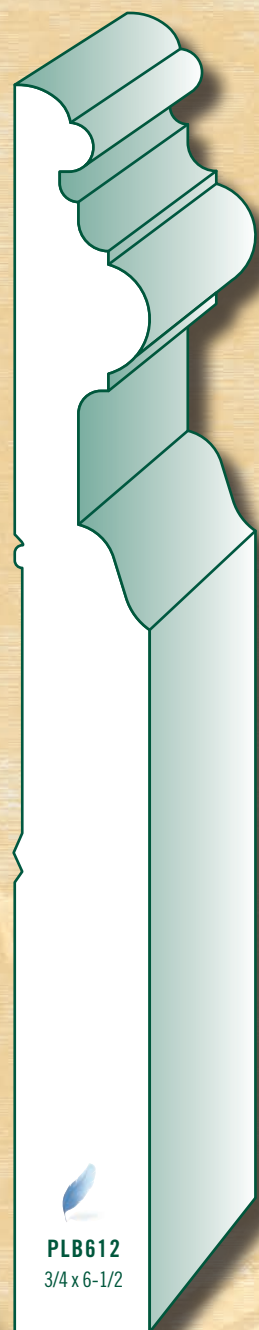

PLB612
3/4 x 6-1/2

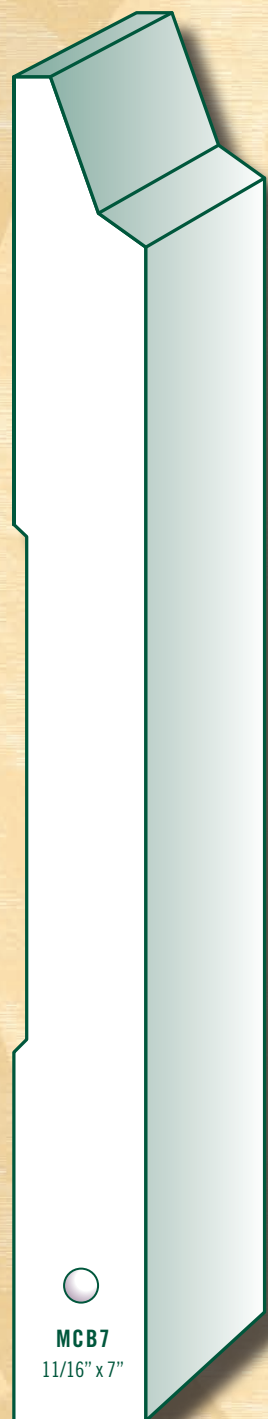

MCB7
11/16" x 7"

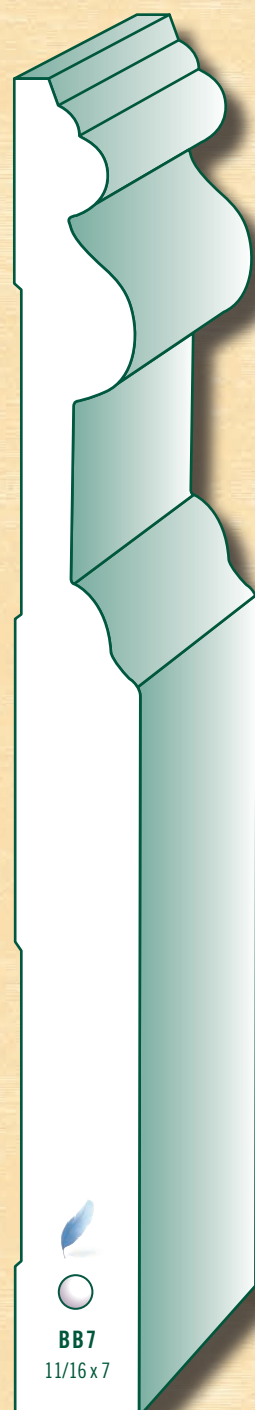

BB7
11/16 x 7

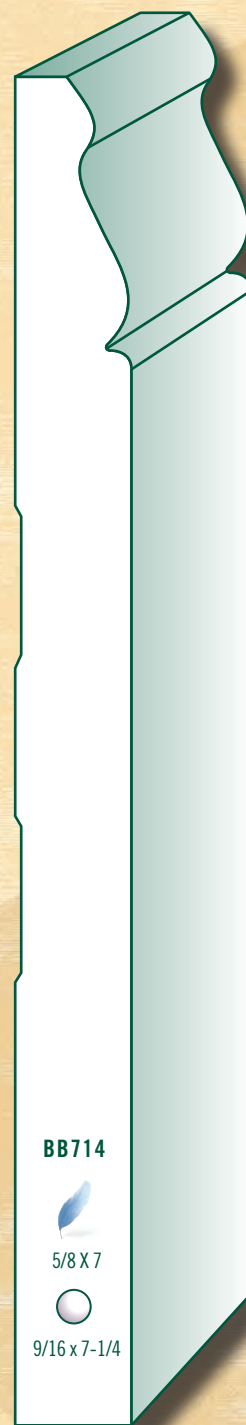

BB714
5/8 x 7
9/16 x 7-1/4

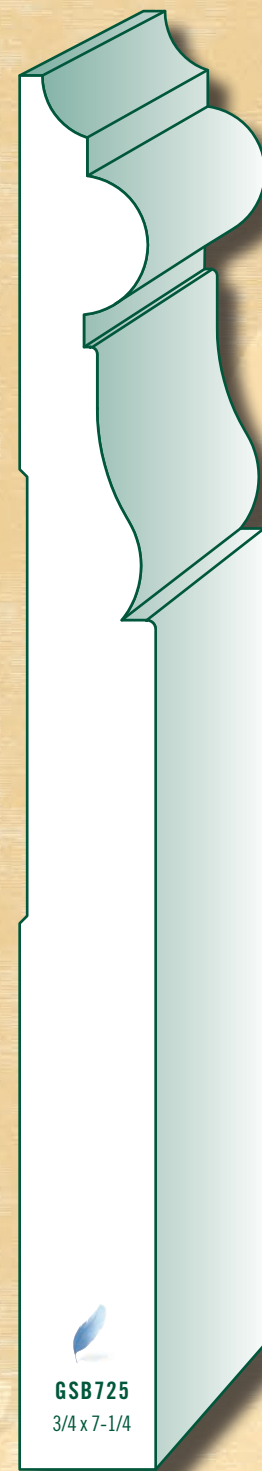

GSB725
3/4 x 7-1/4

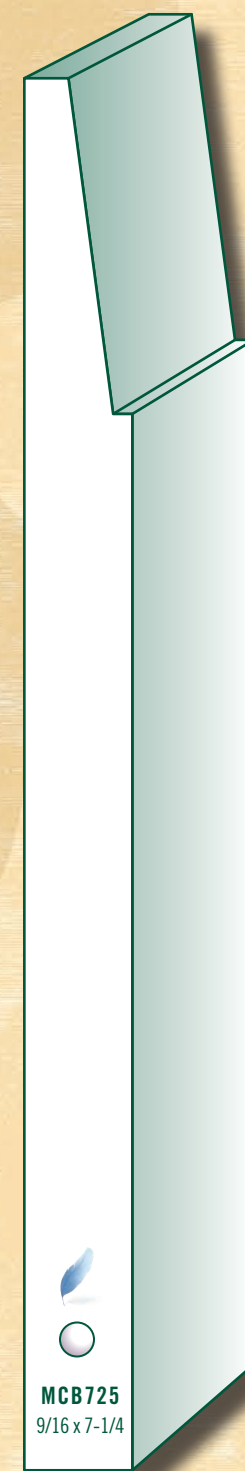

MCB725
9/16 x 7-1/4



PLB714
5/8 x 7-1/4
BB738
11/16 x 7-3/8

3/8"
5/16"

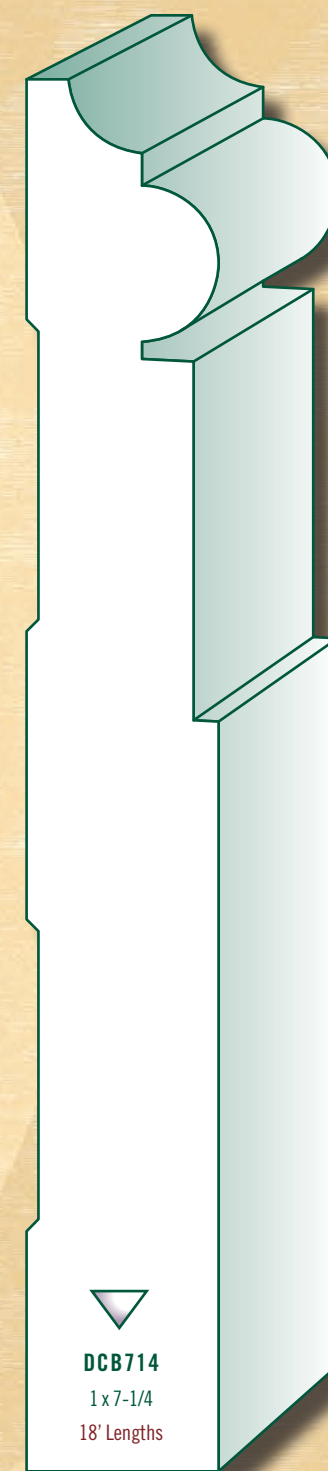

DCB714
1 x 7-1/4
18' Lengths

THE METRO COLLECTION

THE METRO COLLECTION

THE DESIGNER COLLECTION

All profiles are available in select hardwood species on a special order basis (see pages 127-133 for our hardwood moulding programs)

● PINE ● PRIMED ● OAK ● ULTRALITE MDF ● PRIMED POPLAR ● POPLAR ● PVC



BASES

BASES



DCB775

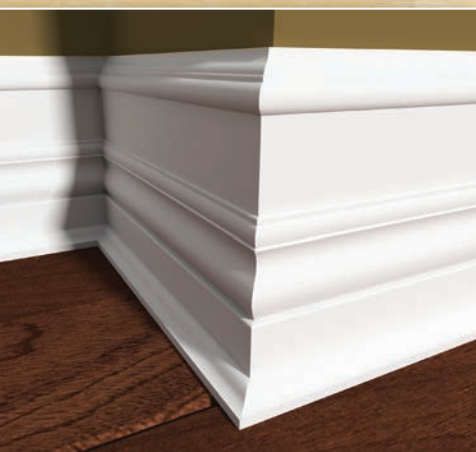

PLB8 & 8423



DCB8

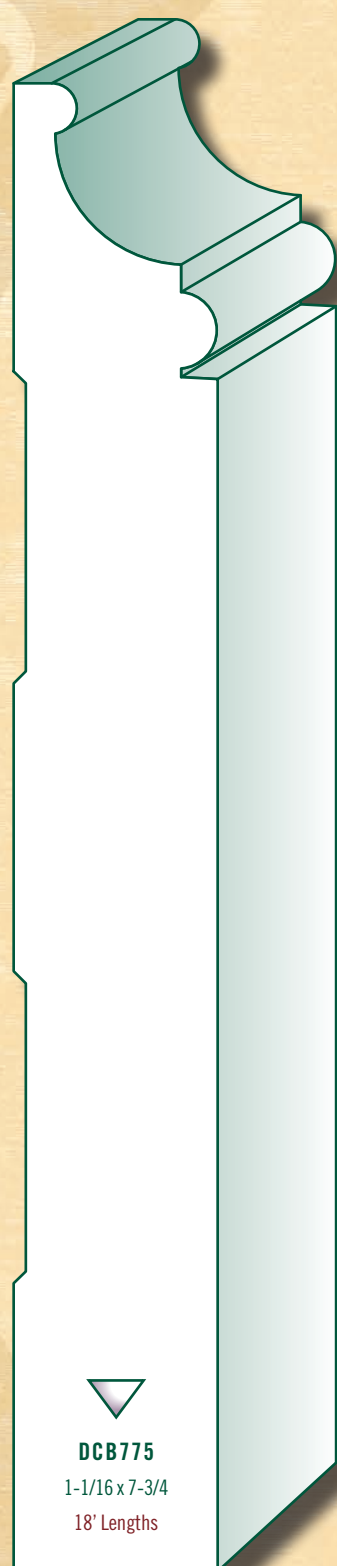

▽
DCB775
1-1/16 x 7-3/4
18' Lengths

The DESIGNER COLLECTION

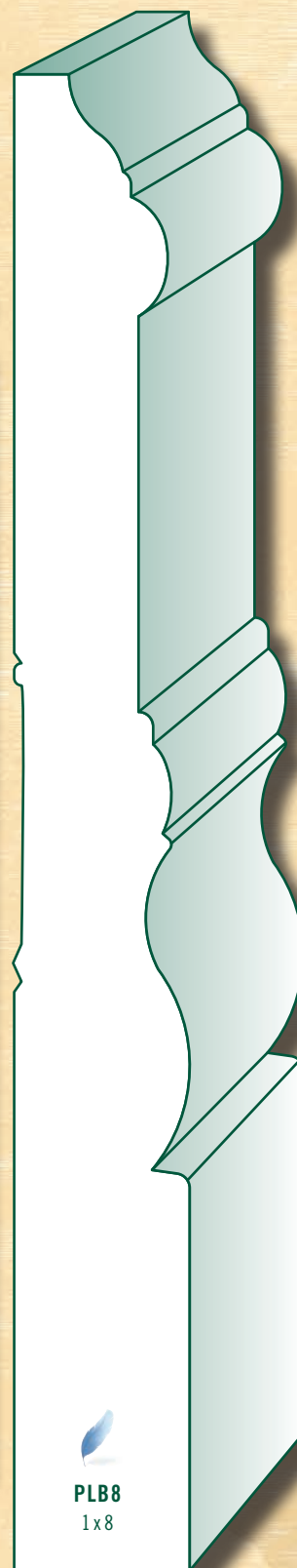

●
PLB8
1 x 8

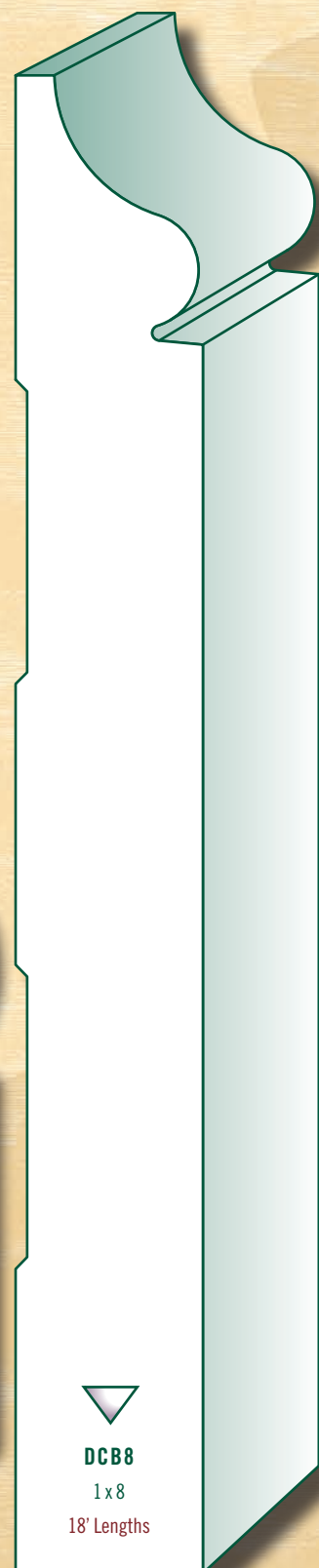

▽
DCB8
1 x 8
18' Lengths

The DESIGNER COLLECTION

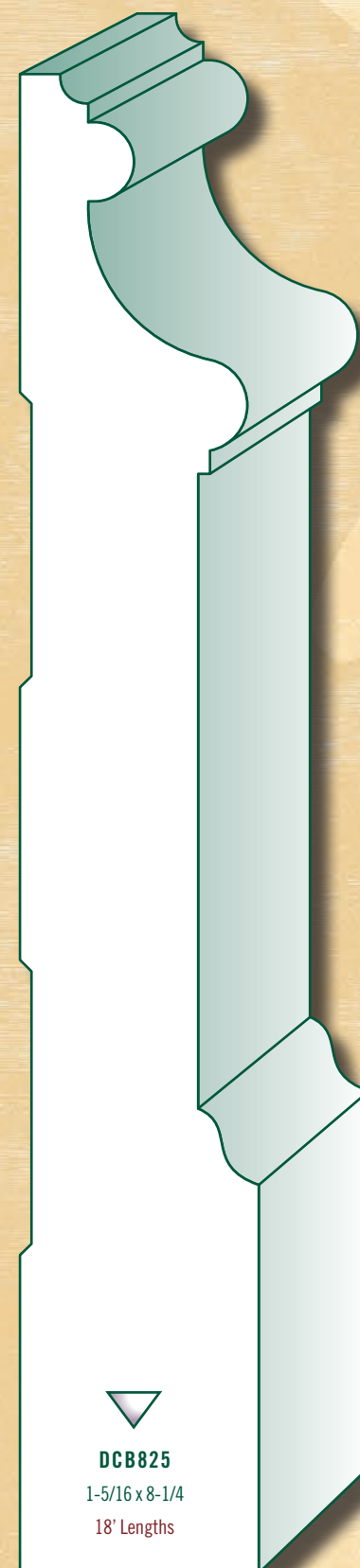

▽
DCB825
1-5/16 x 8-1/4
18' Lengths

The DESIGNER COLLECTION

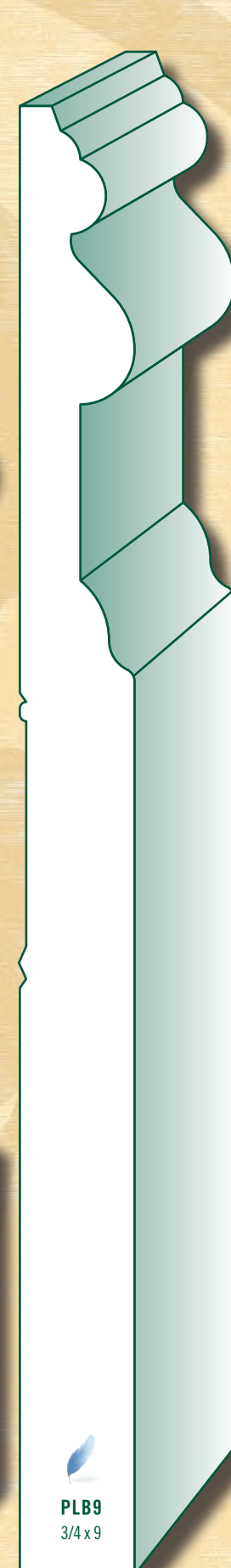

●
PLB9
3/4 x 9

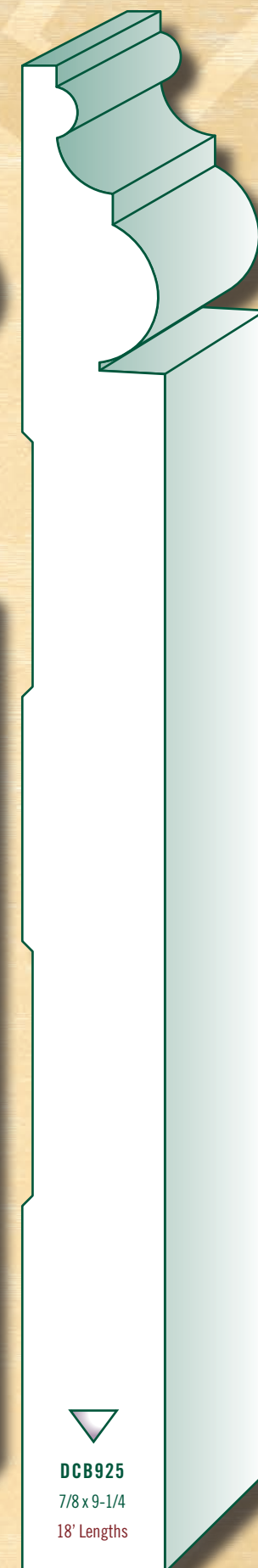

▽
DCB925
7/8 x 9-1/4
18' Lengths

The DESIGNER COLLECTION



DCB825



PLB9 & LWM903



DCB925

All profiles are available in select hardwood species on a special order basis (see pages 127-133 for our hardwood moulding programs)

● PINE ● PRIMED ◆ OAK ● ULTRALITE MDF ▽ PRIMED POPLAR ▽ POPLAR ● PVC

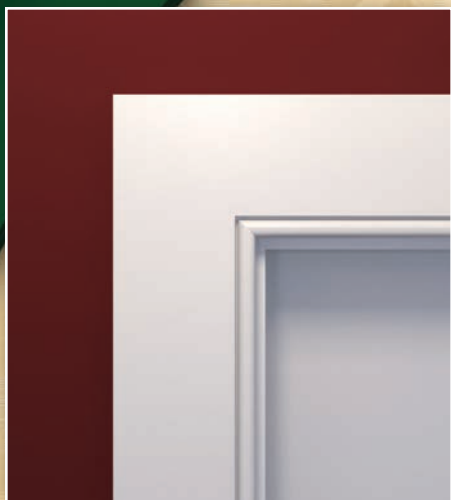

BDB35

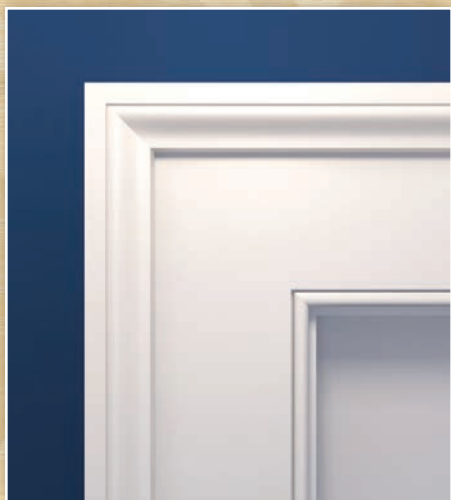

BDB45 & ES16

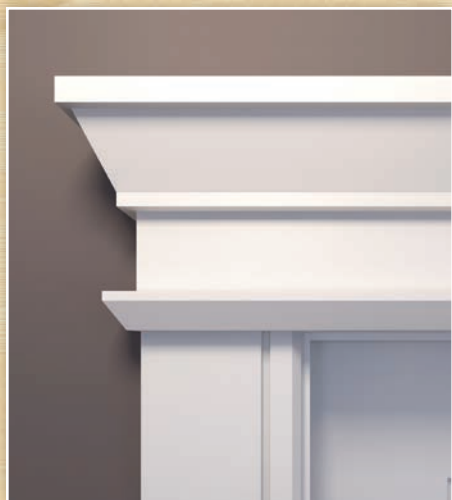

MCC412, MCS1, MSC275, 5/4" x 6"

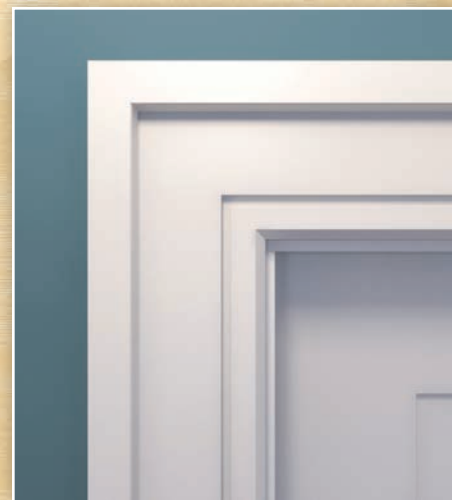

MCC312 Casing & MCBB1 Back Band

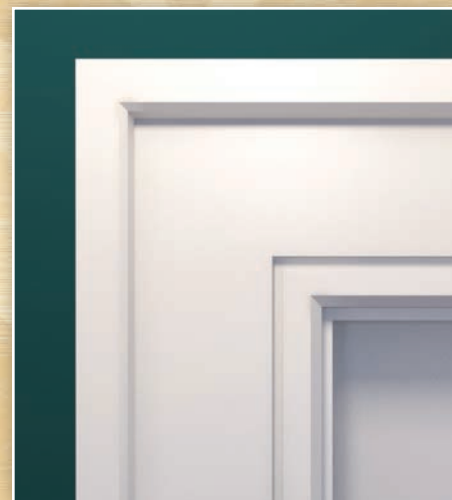

MCC412 Casing & MCBB2 Back Band

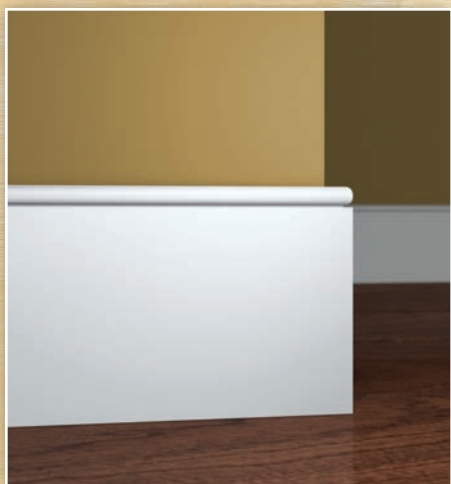

BDB55

**CASINGS/BASES –
BEADED**

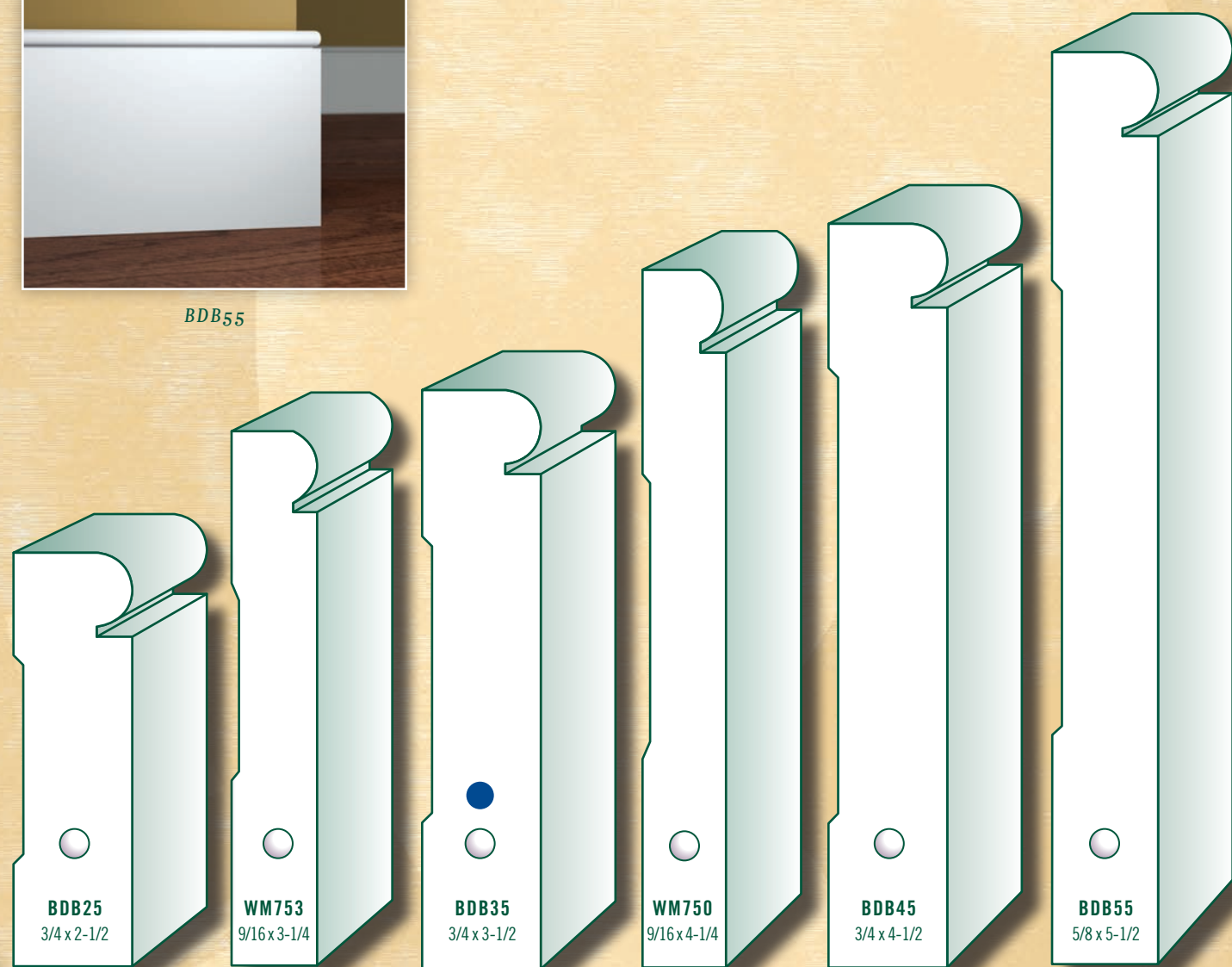

BDB25
3/4 x 2-1/2

WM753
9/16 x 3-1/4

BDB35
3/4 x 3-1/2

WM750
9/16 x 4-1/4

BDB45
3/4 x 4-1/2

BDB55
5/8 x 5-1/2



MCB512 Base, MCS1 Shoe

**CASINGS/BASES –
GROOVED**

See pages 74-108 for our full
Metro Collection offering

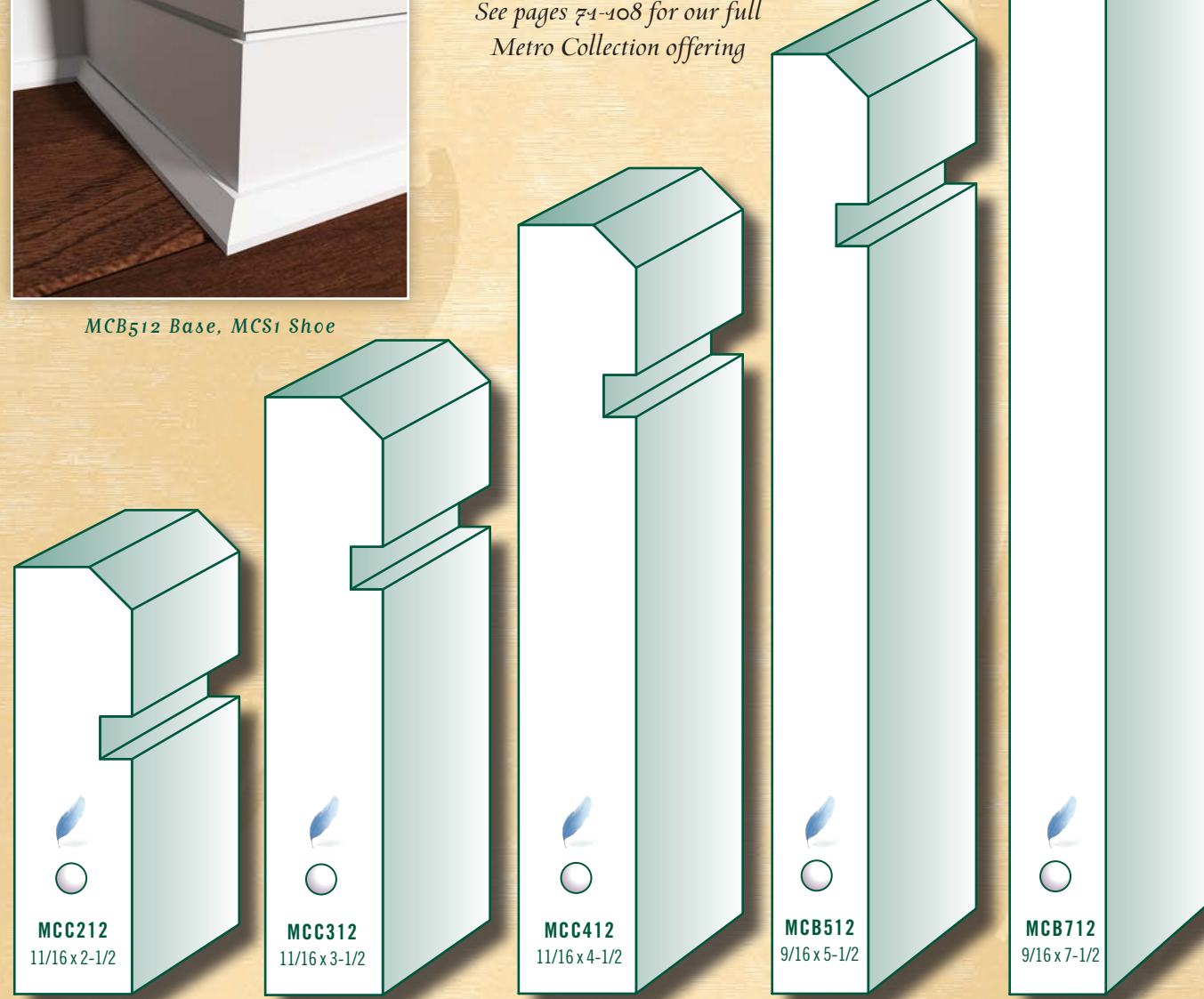

MCC212
11/16 x 2-1/2

MCC312
11/16 x 3-1/2

MCC412
11/16 x 4-1/2

MCB512
9/16 x 5-1/2

MCB712
9/16 x 7-1/2

METRO
COLLECTION

METRO
COLLECTION

METRO
COLLECTION

METRO
COLLECTION

METRO
COLLECTION

All profiles are available in select hardwood species on a special order basis (see pages 127-133 for our hardwood moulding programs)

PINE
 PRIMED
 OAK
 ULTRALITE MDF
 PRIMED POPLAR
 POPLAR
 PVC



Base, Panel & Cap: SAN525 Base, 1/4" x 1/4" Modern Groove 6" O.C., MSC175 Solid Crown, B8121
 Window: MCC312 Casing, MCB2 Back Band, LS6 Stool, MSC175 Solid Crown

CASINGS/BASES - SANITARY

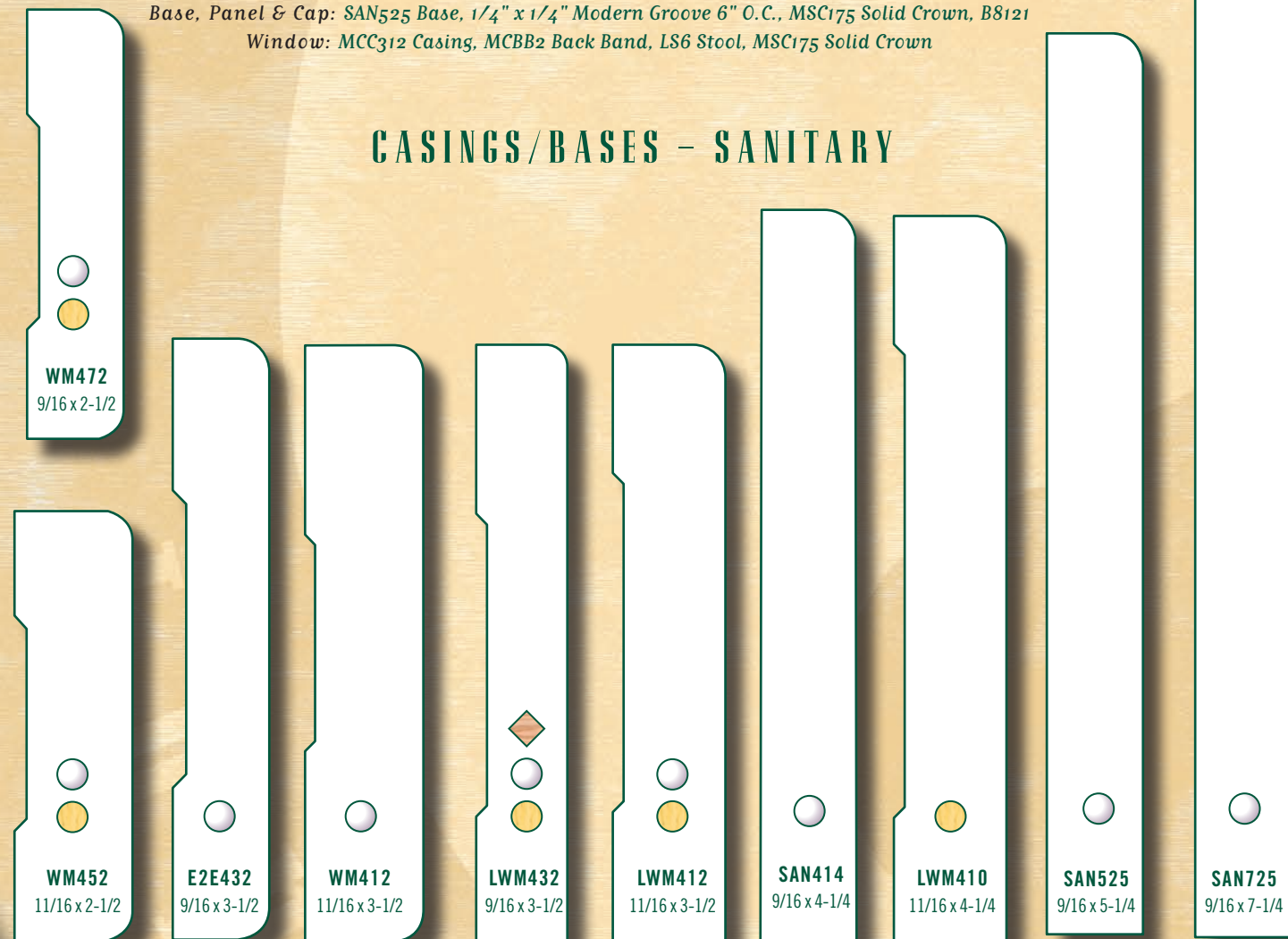

BACK BANDS

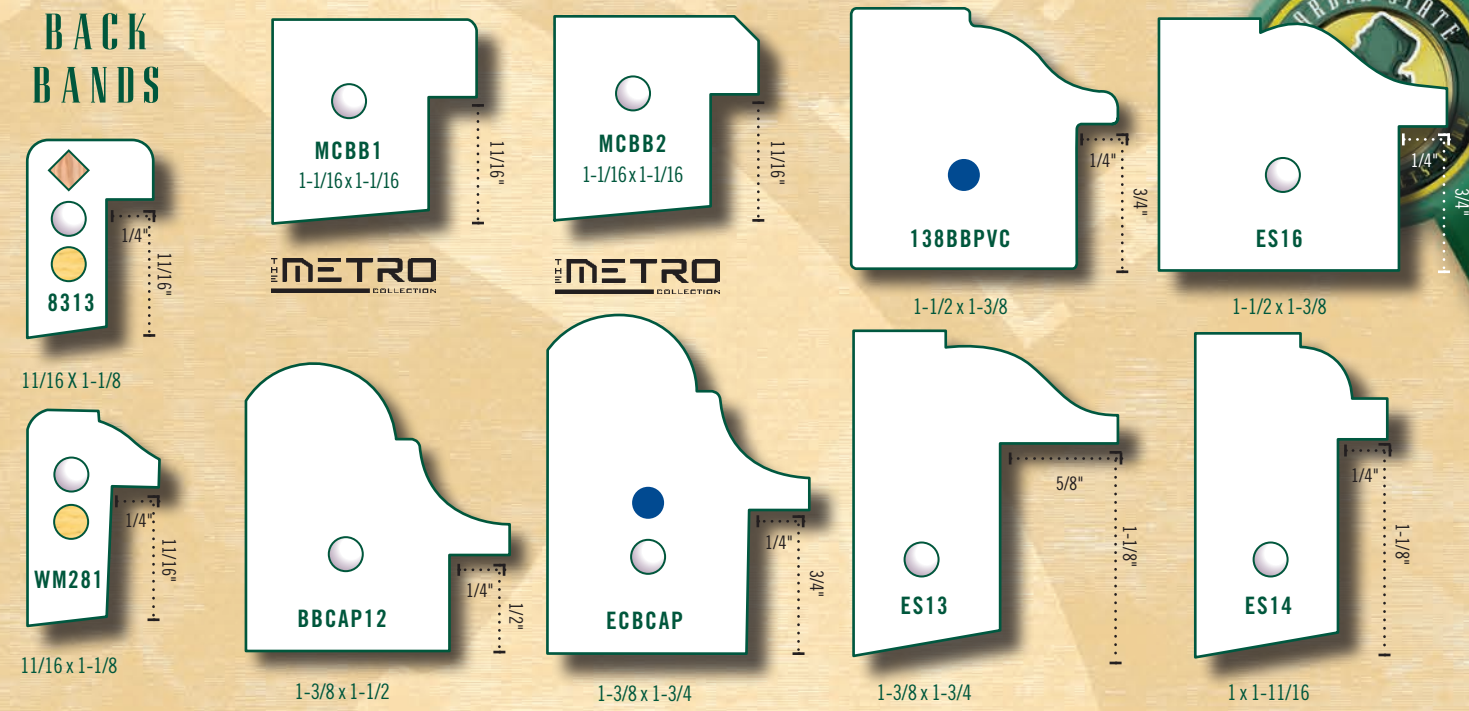

CASINGS - FLUTED/REEDED

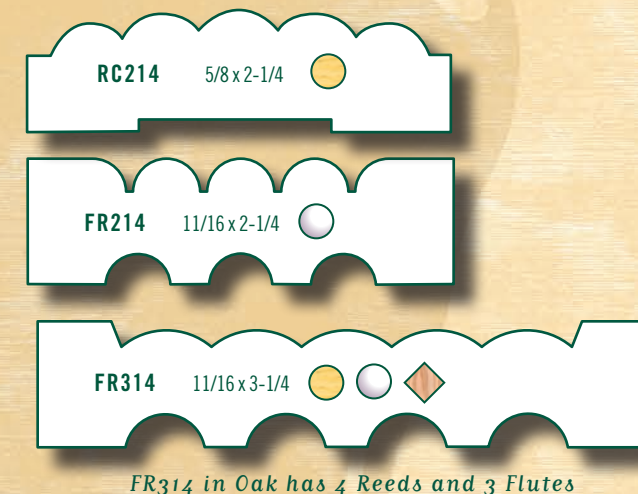

SC234 Crown, 8577 Nose & Cove, 5/4" x 6" & FR314 Fluted/Reeded Casing

PILASTERS

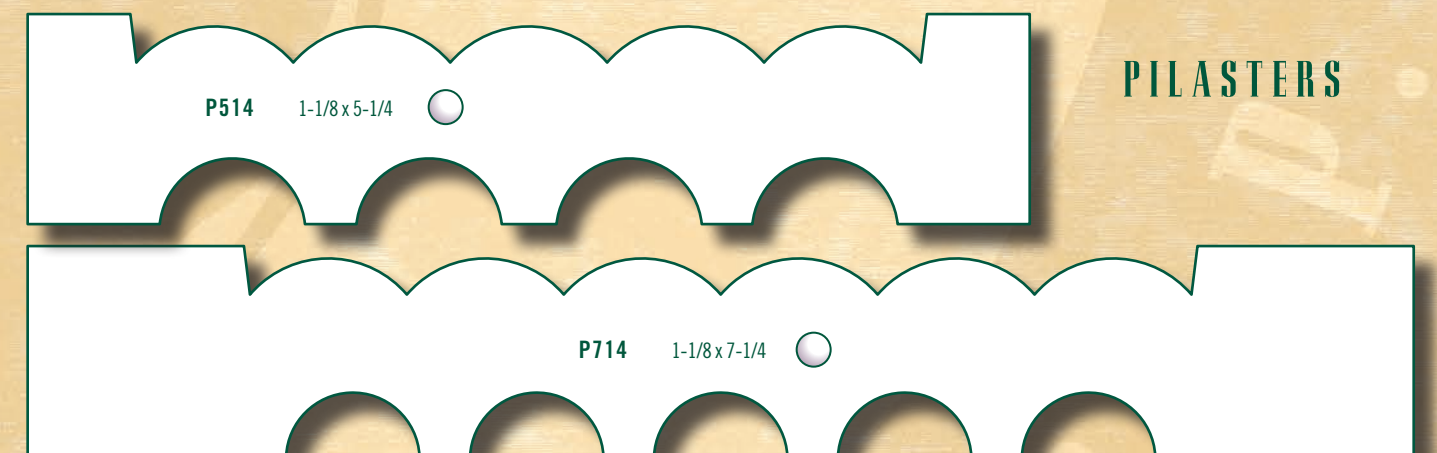

All profiles are available in select hardwood species on a special order basis (see pages 127-133 for our hardwood moulding programs)

● PINE
 ● PRIMED
 ◆ OAK
 ■ ULTRALITE MDF
 ▽ PRIMED POPLAR
 ▽ POPLAR
 ● PVC

CASINGS - COLONIAL

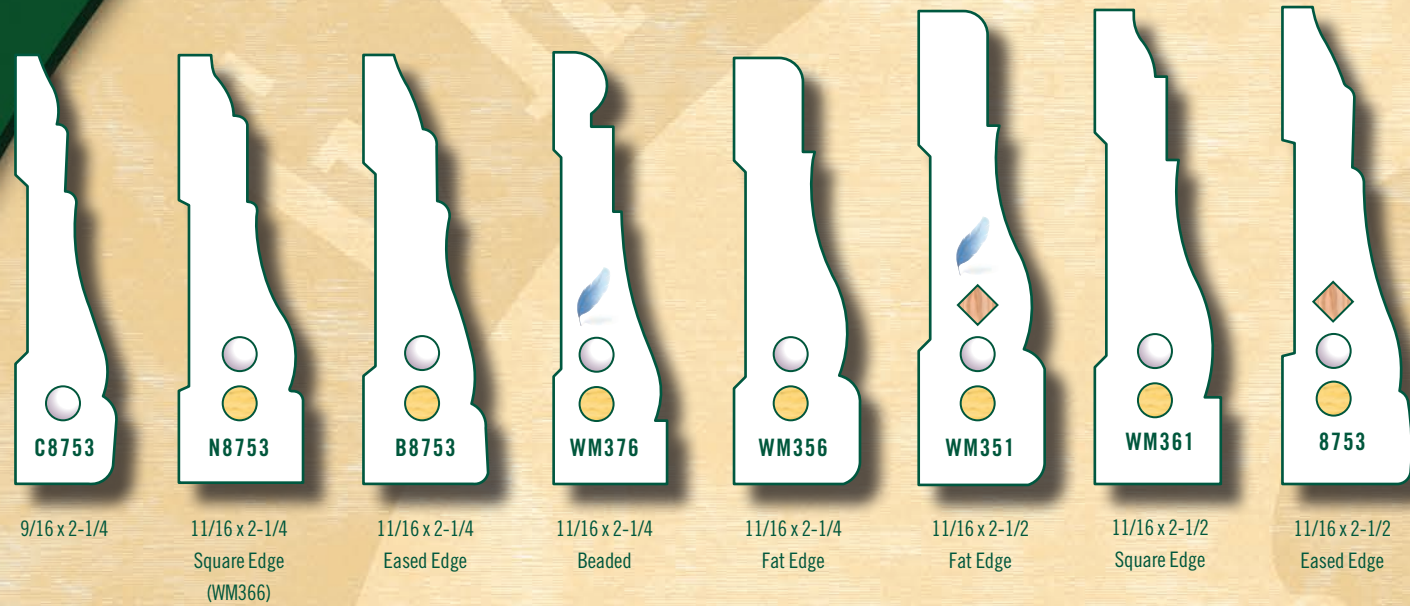

CASINGS - CLAM

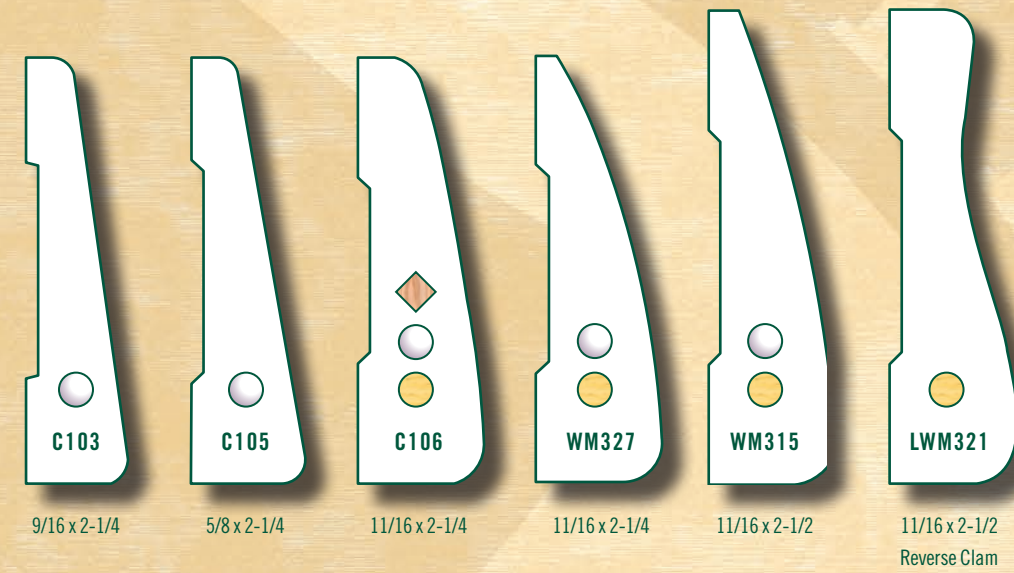

CASING - UNIQUE



WM97



WC1

CASINGS - SPECIAL

CASING - EXTERIOR

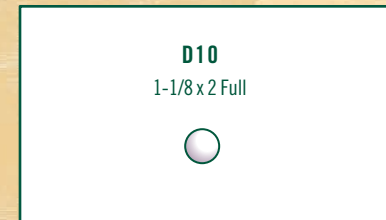

BRICK MOULDING

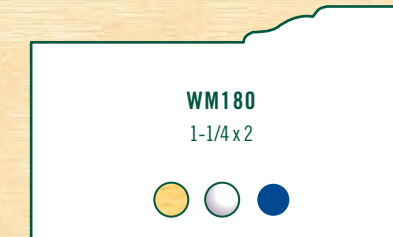

CASINGS - COLONIAL

CASING - STAFFORD

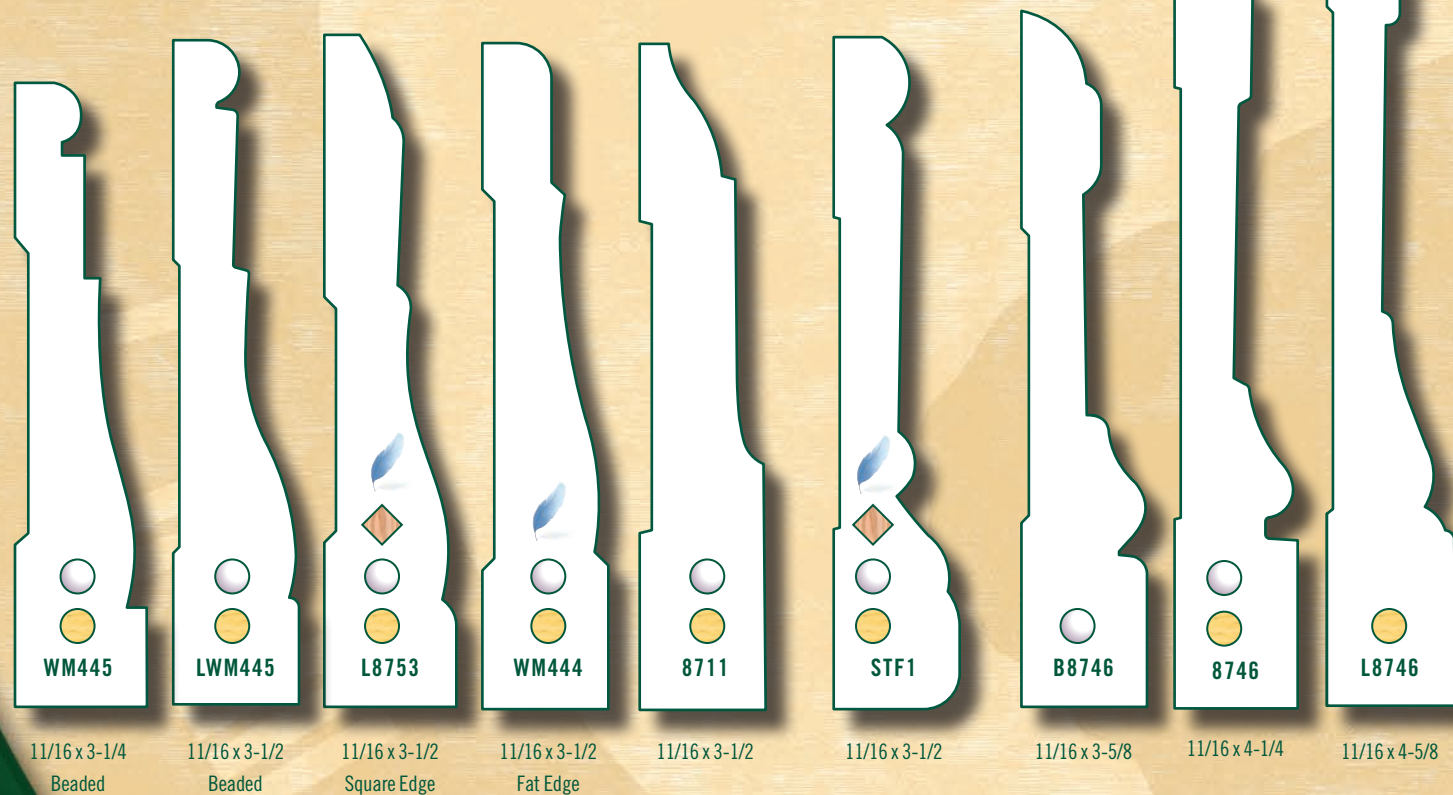

CASINGS - WINDSOR

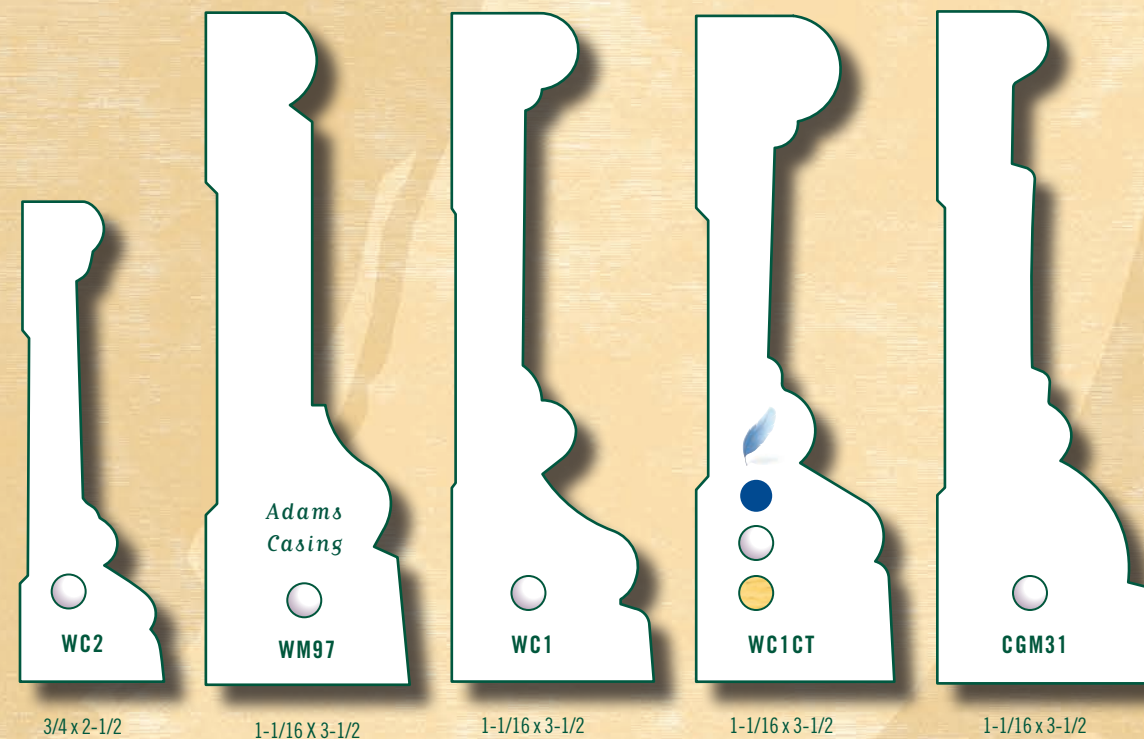

WC1CT



CGM31

All profiles are available in select hardwood species on a special order basis (see pages 127-133 for our hardwood moulding programs)

● PINE
 ● PRIMED
 ◆ OAK
 ▲ ULTRALITE MDF
 ▽ PRIMED POPLAR
 ▽ POPLAR
 ● PVC



CASINGS

CASINGS

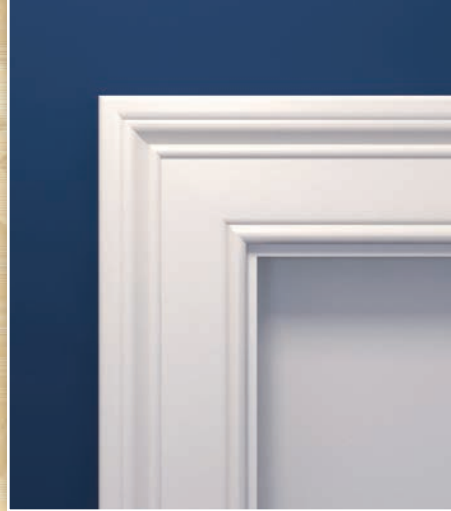

STF1



LK3



GS694

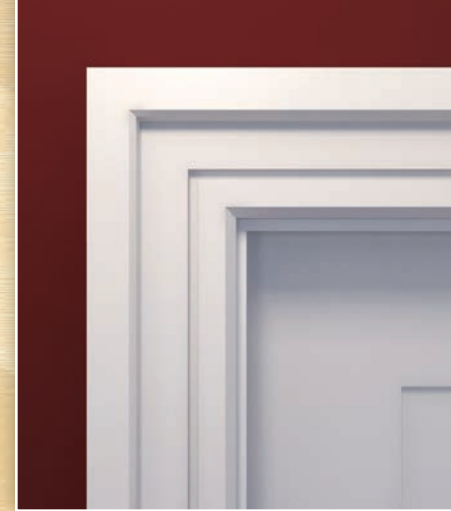

MCC212 with MCBB2



ES2



ES1



GS119



PM2200



MCC334



MCC375

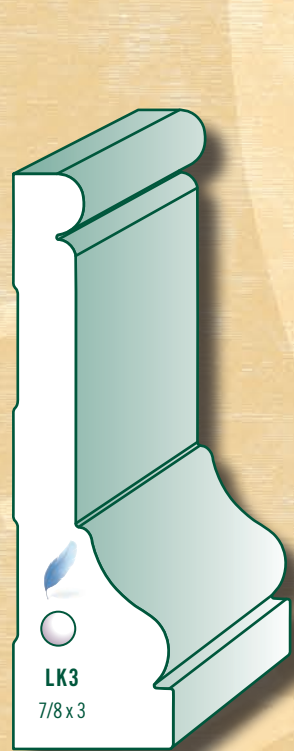

LK3
7/8 x 3

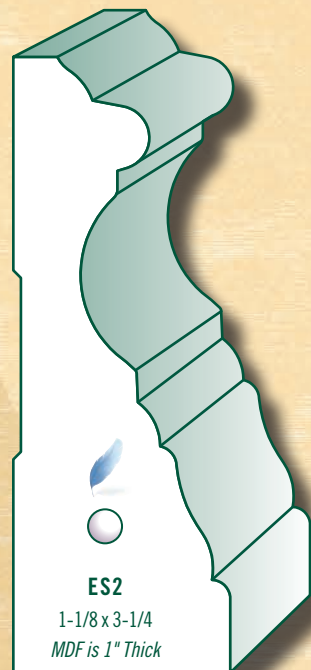

ES2
1-1/8 x 3-1/4
MDF is 1" Thick



ES1
3/4 x 3-1/2

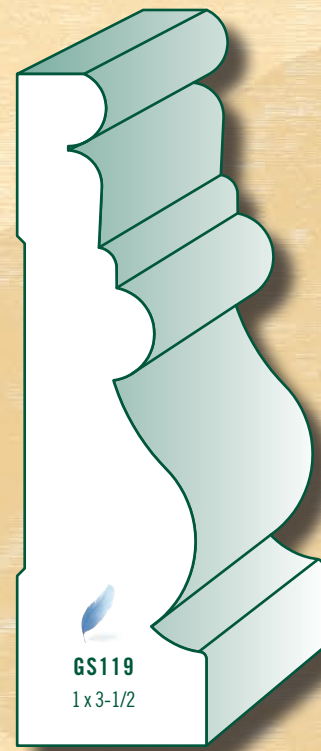

GS119
1 x 3-1/2

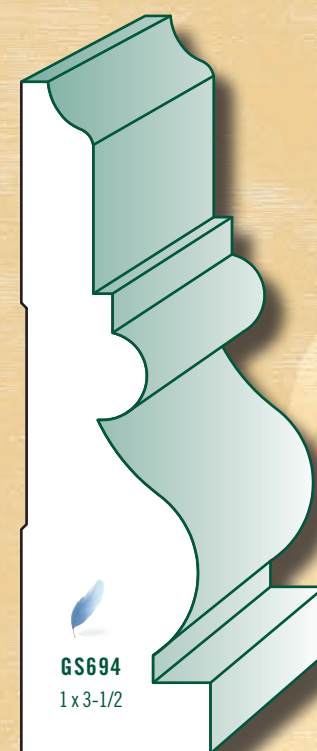

GS694
1 x 3-1/2

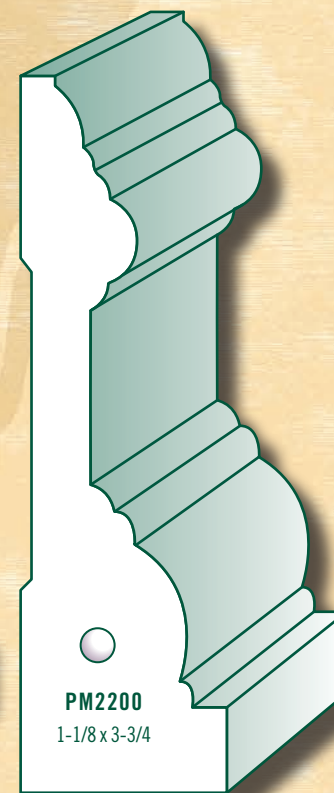

PM2200
1-1/8 x 3-3/4

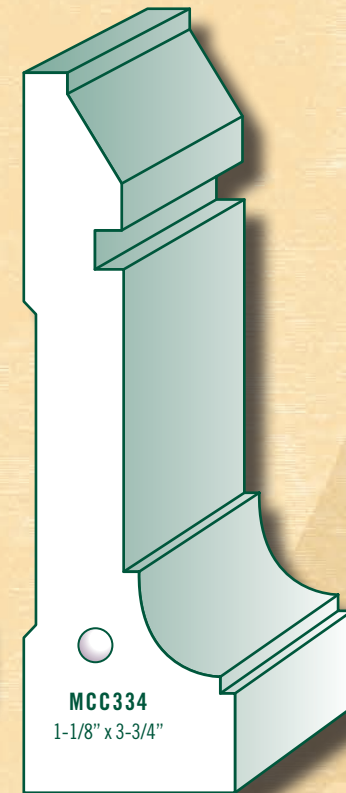

MCC334
1-1/8" x 3-3/4"

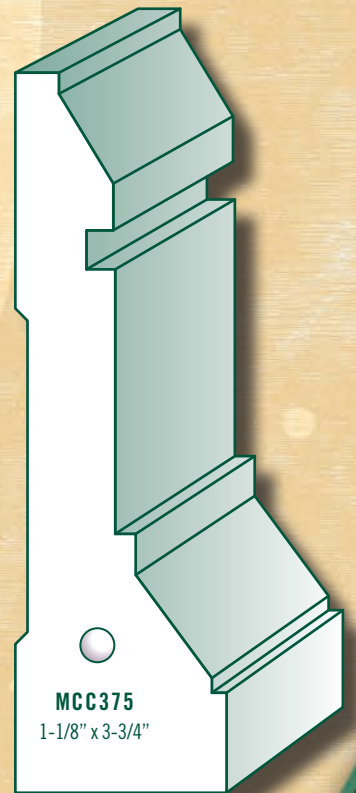

MCC375
1-1/8" x 3-3/4"



All profiles are available in select hardwood species on a special order basis (see pages 127-133 for our hardwood moulding programs)

● PINE
 ● PRIMED
 ◆ OAK
 ◆ ULTRALITE MDF
 ▽ PRIMED POPLAR
 ▽ POPLAR
 ● PVC



CASINGS

CASINGS

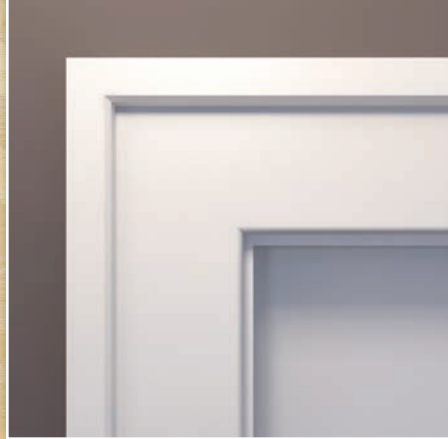

LWM412 & MCBB2



ES4 & ES14

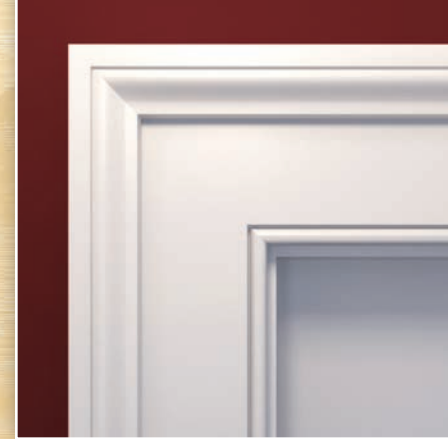

BDB35 & ES16



BDB45 & ECBCAP

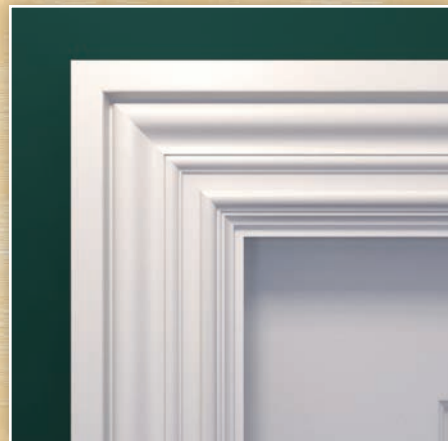

PL378



GS400

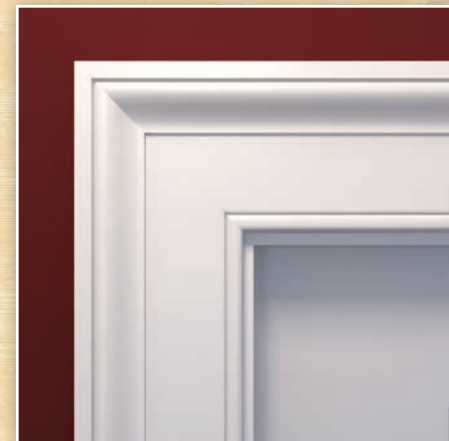

LK4



DC400



ES4



GS425

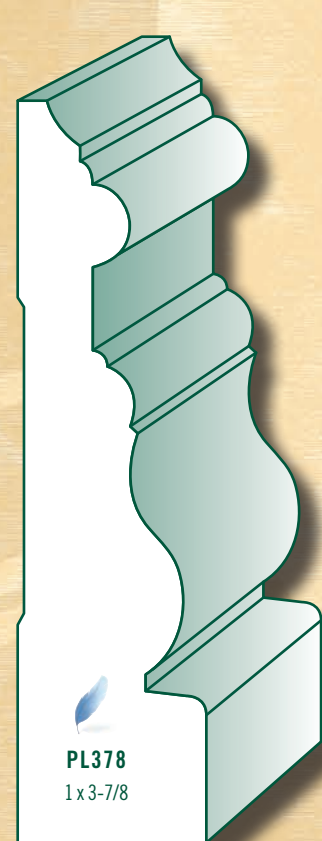

PL378
1x3-7/8



GS400
1x4

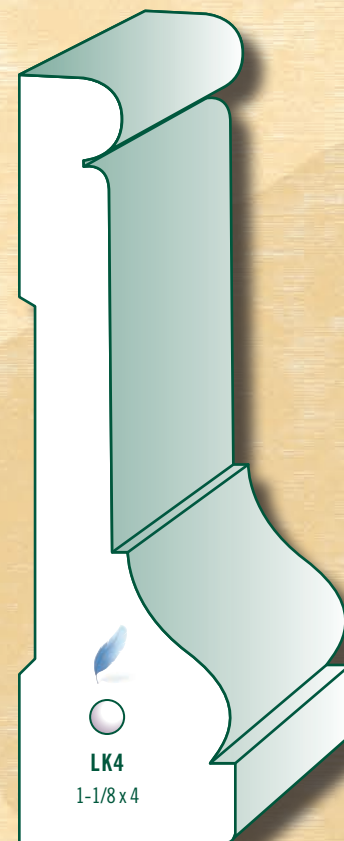

LK4
1-1/8x4

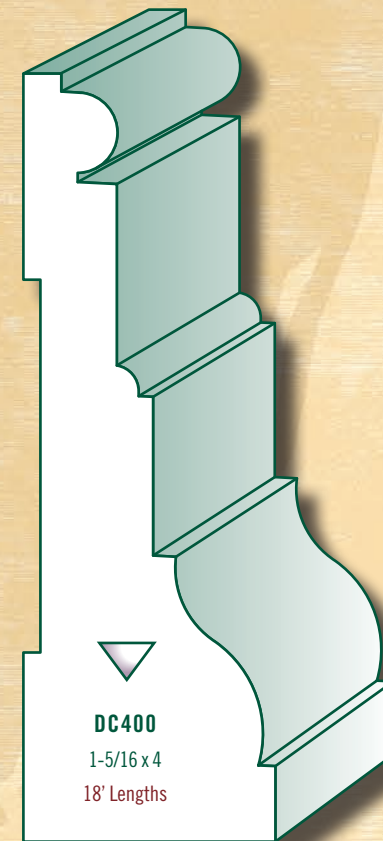

DC400
1-5/16 x 4
18' Lengths



ES4
1x4-1/4

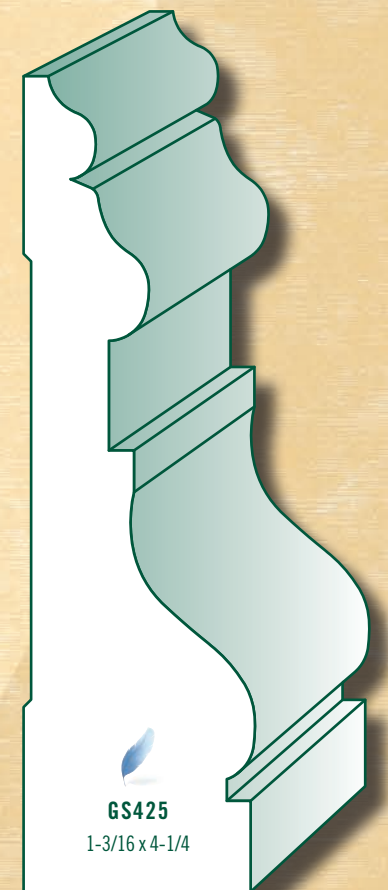

GS425
1-3/16 x 4-1/4

All profiles are available in select hardwood species on a special order basis (see pages 127-133 for our hardwood moulding programs)

● PINE ● PRIMED ● OAK ● ULTRALITE MDF ● PRIMED POPLAR ● POPLAR ● PVC

The DESIGNER COLLECTION



CASINGS

CASINGS

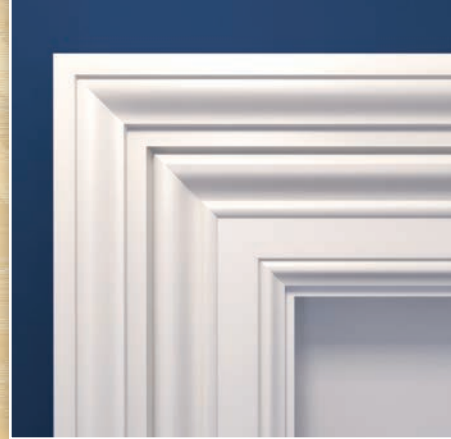

ES3 & ES13

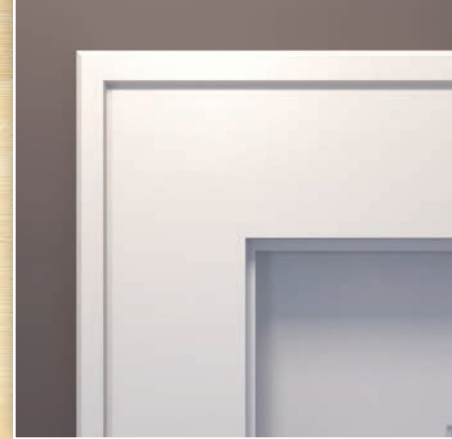

MCAPI & 1x4



DC412 Casing and DCB775 Base



DC412 Casing and DCBB5 Base



GS441



ES12 Casing with Rosette

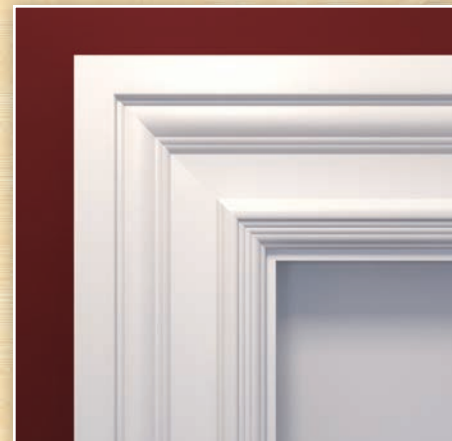

JC412



ES3



GS419



DC412

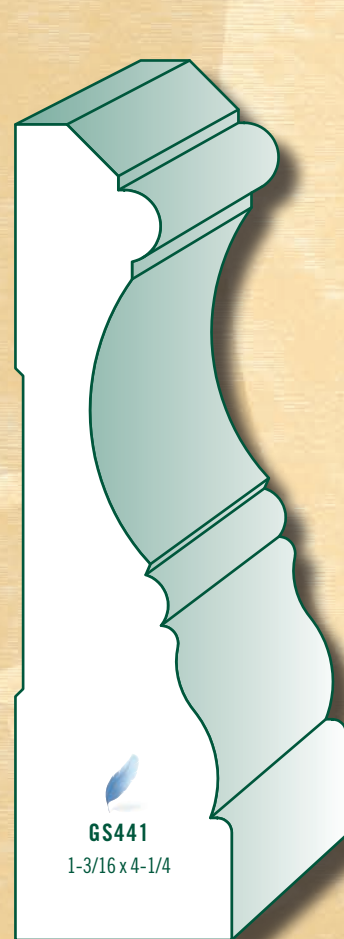

GS441
1-3/16 x 4-1/4

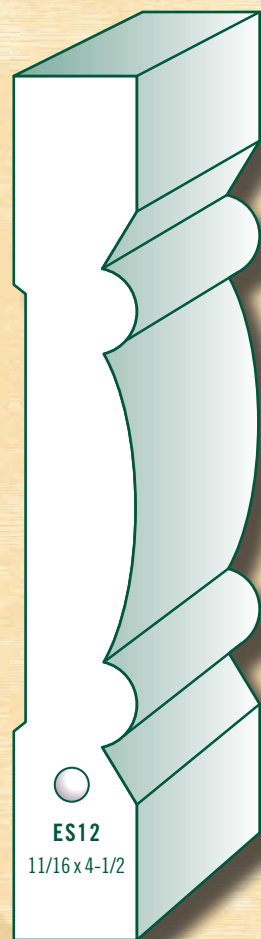

ES12
11/16 x 4-1/2

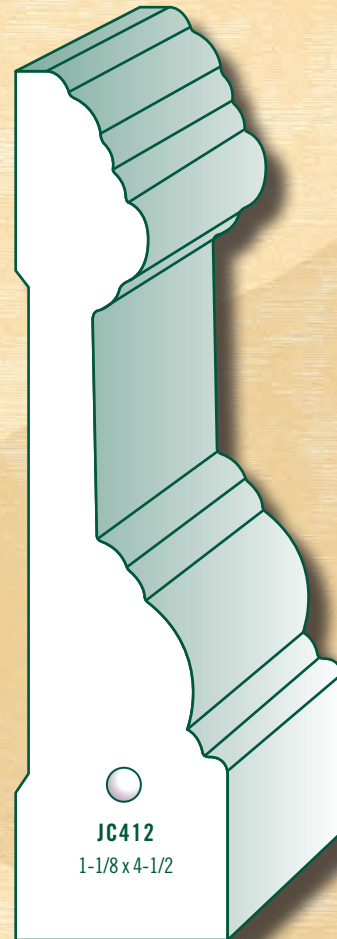

JC412
1-1/8 x 4-1/2

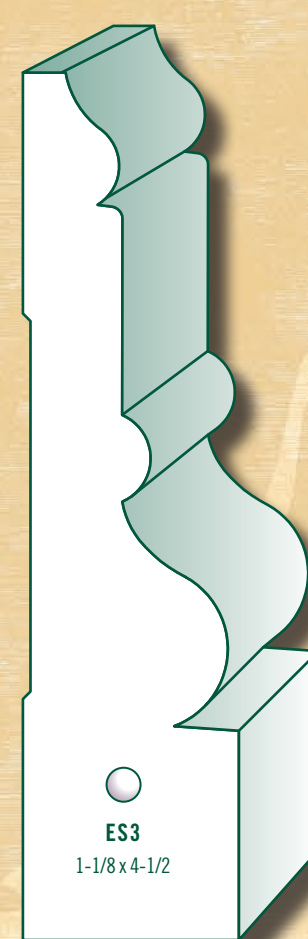

ES3
1-1/8 x 4-1/2



GS419
1-3/16 x 4-1/2

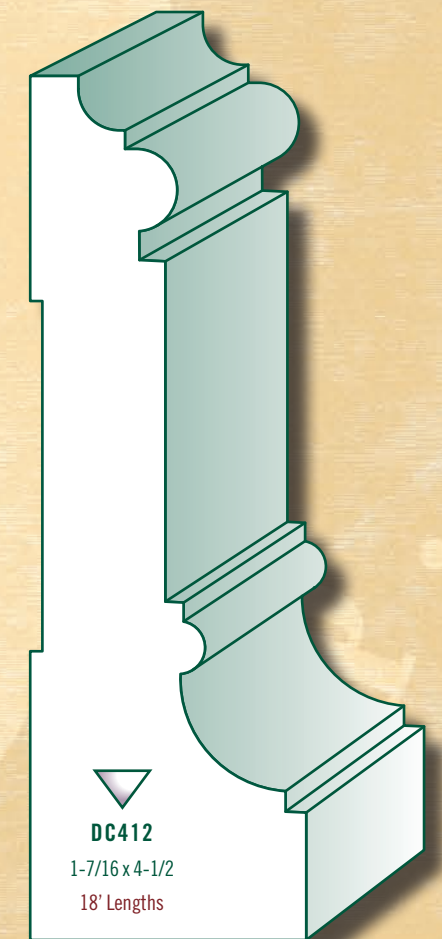

DC412
1-7/16 x 4-1/2
18' Lengths

All profiles are available in select hardwood species on a special order basis (see pages 127-133 for our hardwood moulding programs)

● PINE
 ● PRIMED
 ◆ OAK
 ■ ULTRALITE MDF
 ▽ PRIMED POPLAR
 ▽ POPLAR
 ● PVC



CASINGS

CASINGS



DC400 Casing and DCB525 Base



DC450 Casing and DCB8 Base



MCC475 Casing and MCB7 Base



DCWC5 Casing and DCB534 Base



DC450



PL458



GS434



MCC434



MCC475



DCWC5

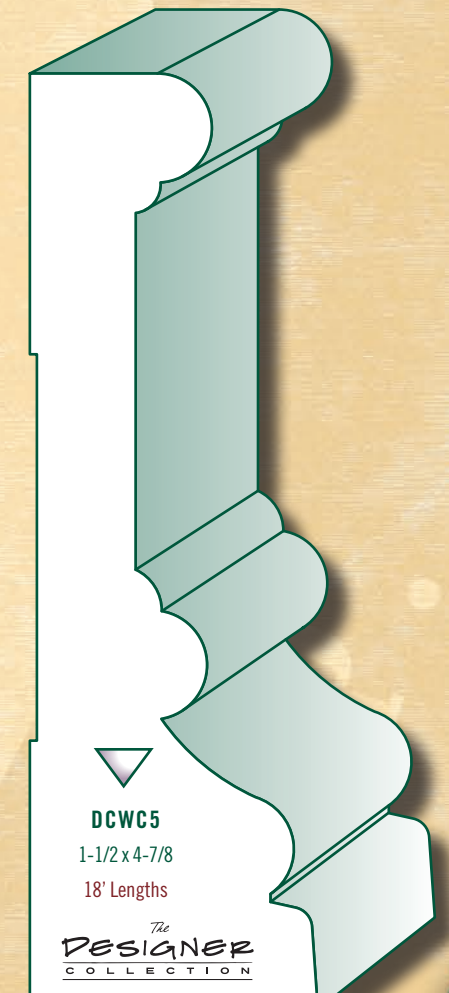
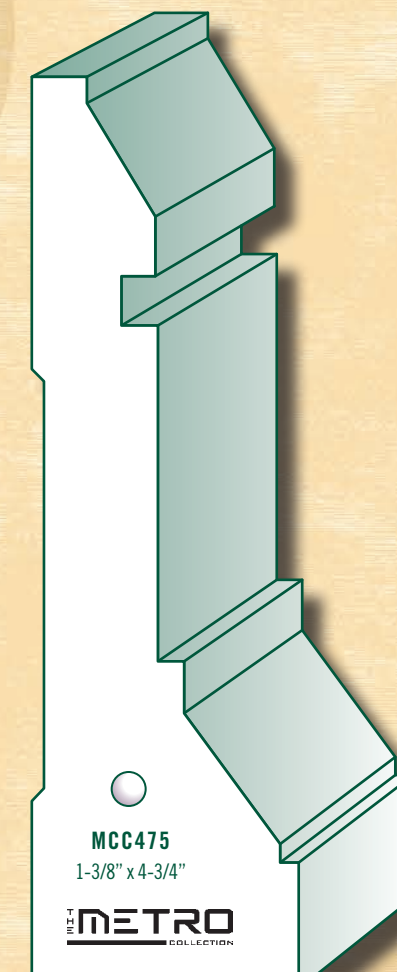
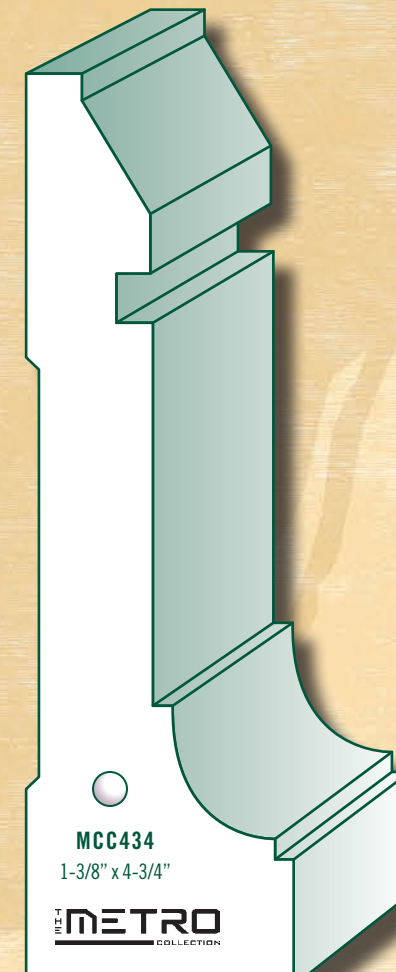
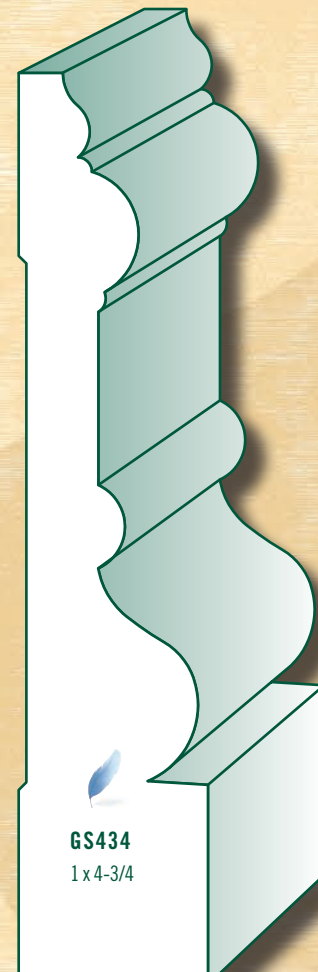
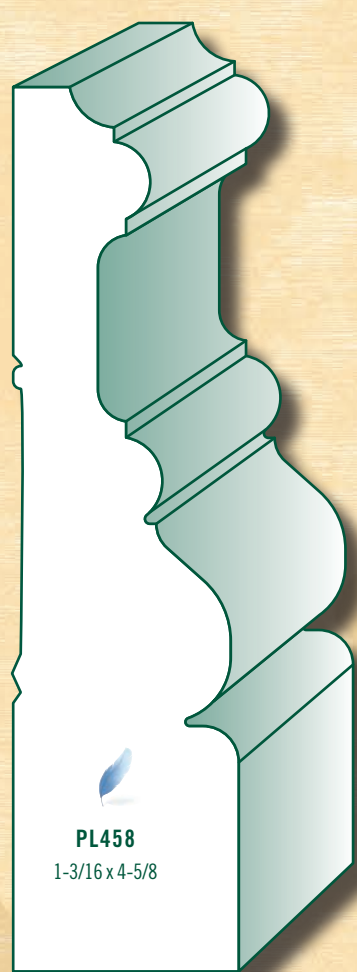
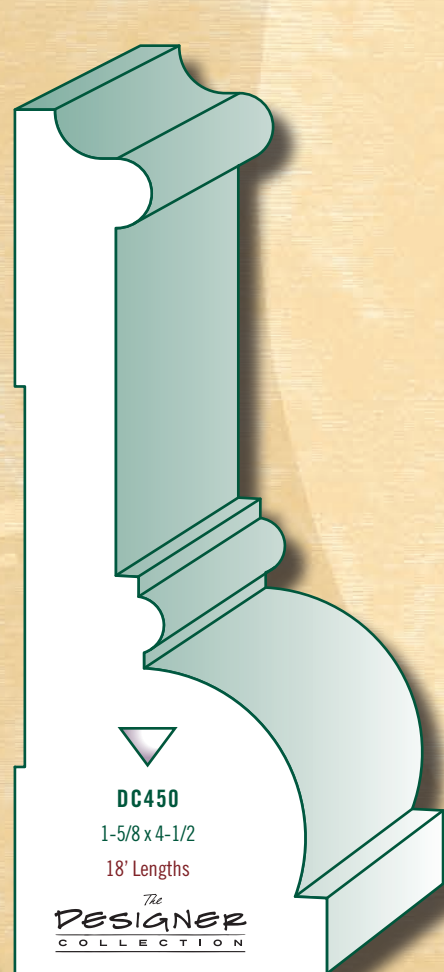

All profiles are available in select hardwood species on a special order basis (see pages 127-133 for our hardwood moulding programs)

● PINE ● PRIMED ◆ OAK ◆ ULTRALITE MDF ▼ PRIMED POPLAR ▼ POPLAR ● PVC



CASINGS

CASINGS



DCLK5 Casing and DCB775 Base



DC499 Casing and DCB714 Base



DC512 Casing and DCB925 Base



DC550 Casing and DCB825 Base



DCLK5



DC499



PL514



DCAS5



DC512

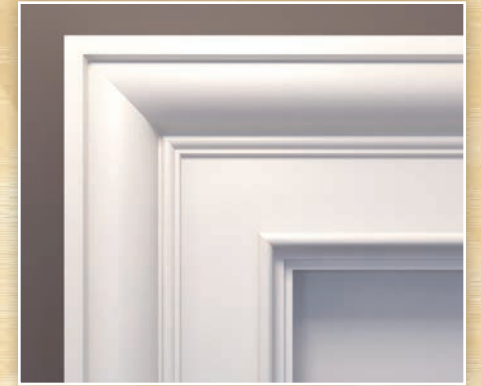

DC550

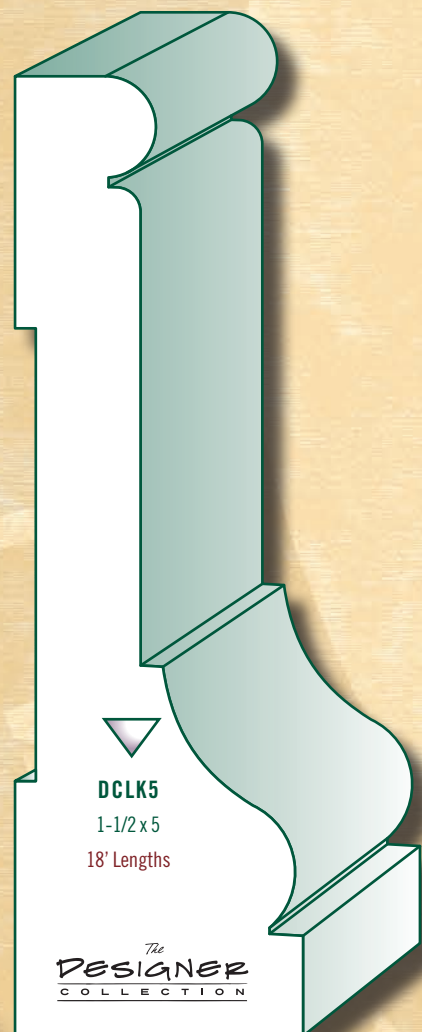

DCLK5
1-1/2 x 5
18' Lengths

The DESIGNER COLLECTION

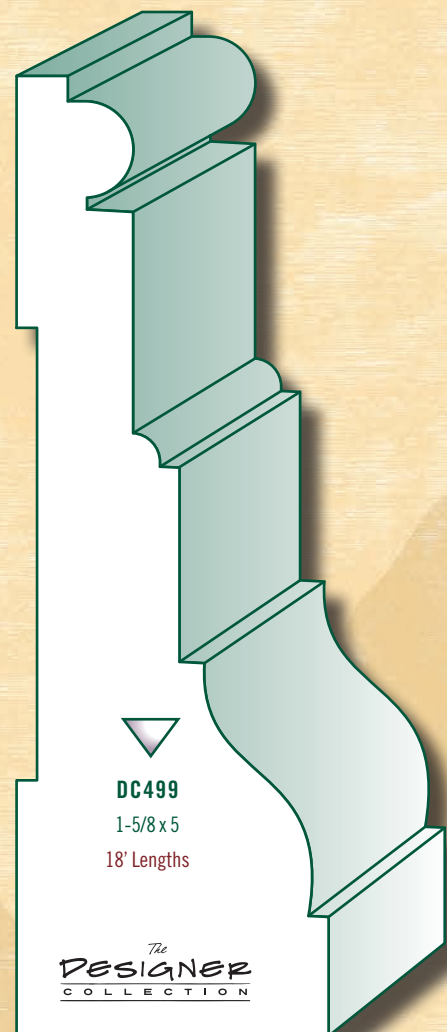

DC499
1-5/8 x 5
18' Lengths

The DESIGNER COLLECTION

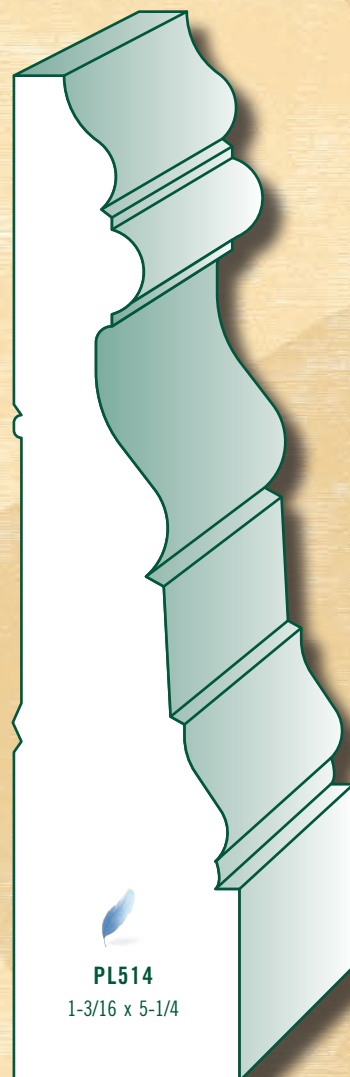

PL514
1-3/16 x 5-1/4

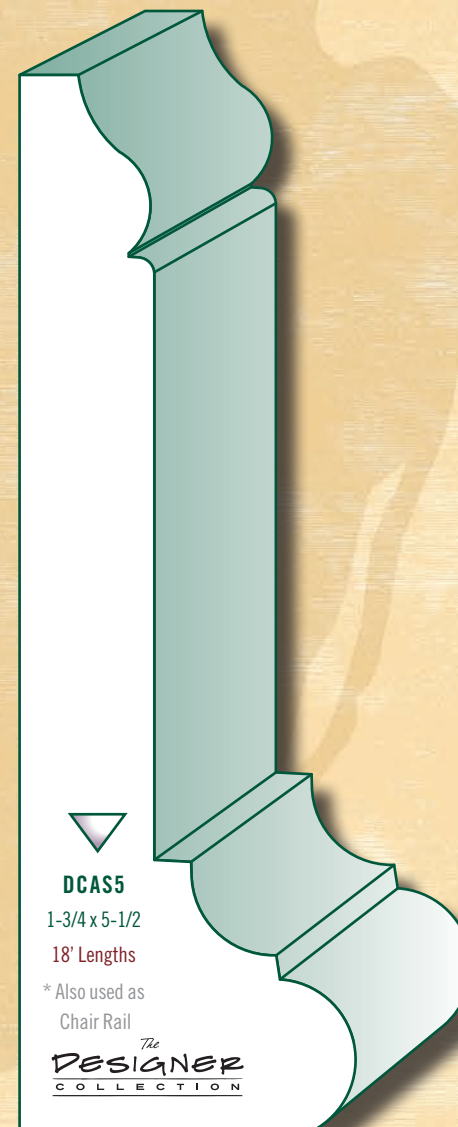

DCAS5
1-3/4 x 5-1/2
18' Lengths

* Also used as
Chair Rail

The DESIGNER COLLECTION

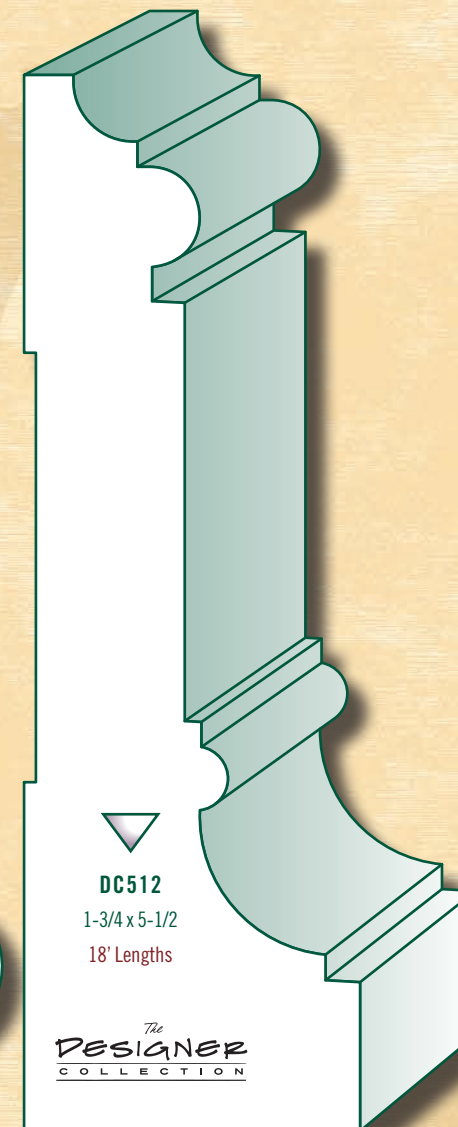

DC512
1-3/4 x 5-1/2
18' Lengths

The DESIGNER COLLECTION

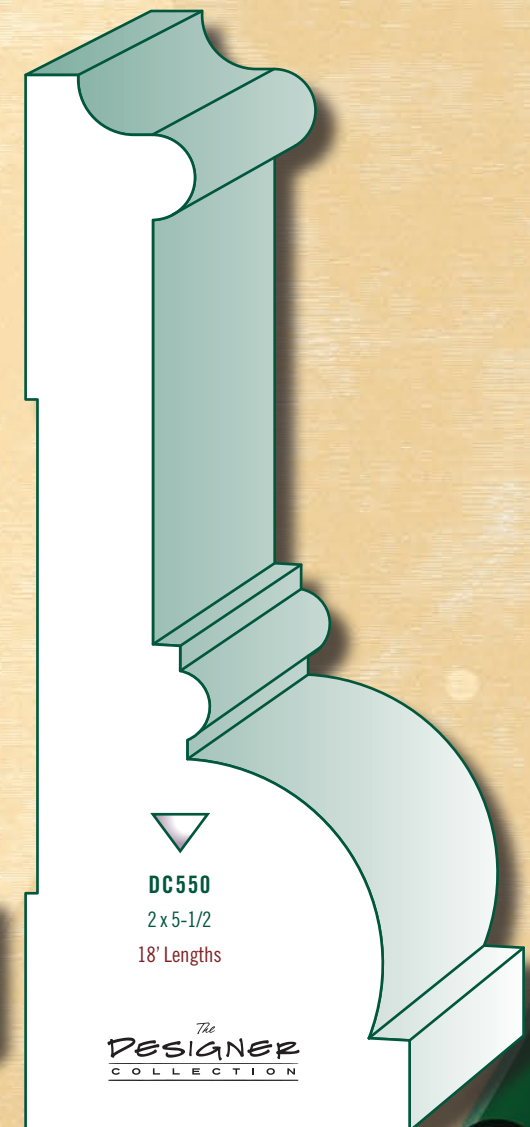

DC550
2 x 5-1/2
18' Lengths

The DESIGNER COLLECTION

CASINGS



PRESTIGE PLINTH BLOCKS

All plinths are available in solid poplar 8' in length - plinths should be cut to a height approximately 1/8" to 1/4" taller than the base moulding being used

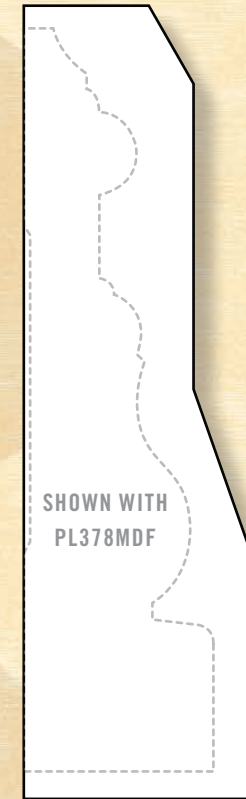

PB418 1-1/4 x 4-1/8
Will accommodate all casings 3-1/4" to 3-7/8" in width

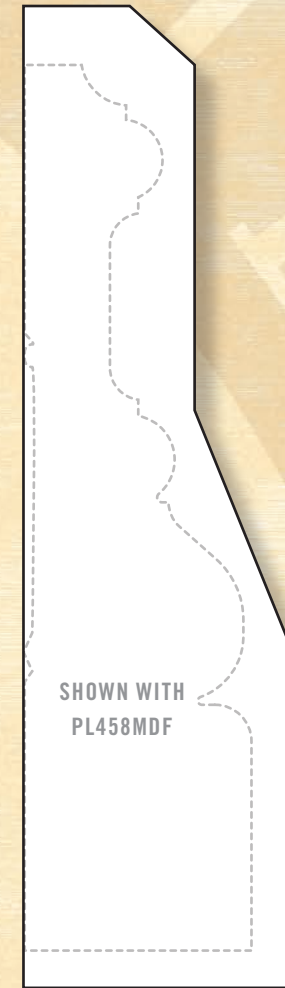

PB518 1-7/16 x 5-1/8
Will accommodate all casings and most casing/backband combinations 4" to 4-7/8" in width

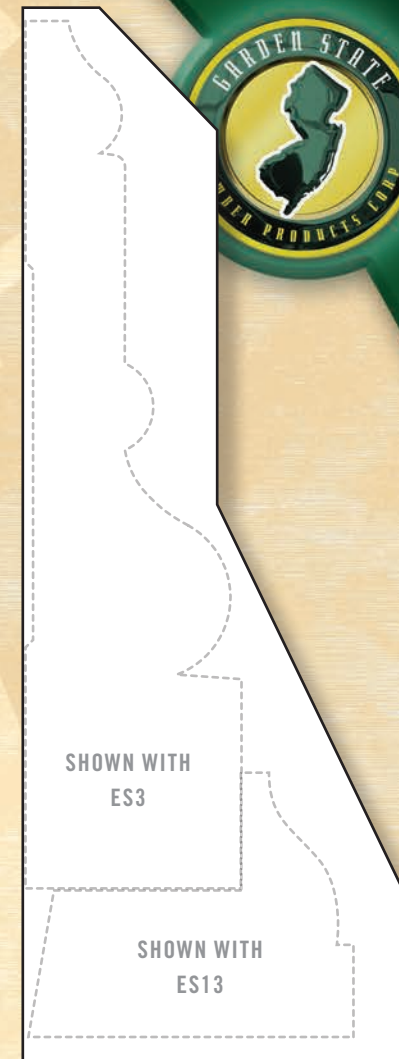

PB550 2 x 5-1/2
Will accommodate all casings and most casing/backband combinations 4-7/8" to 5-1/4"



Panels: MCAP2,
Columns: MCC575, MCAP2

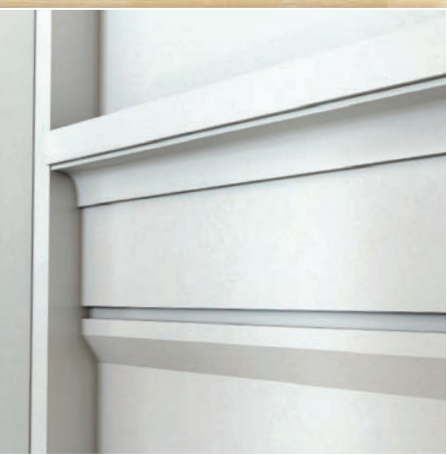

MCC534 Used as Chair Rail

MCC534

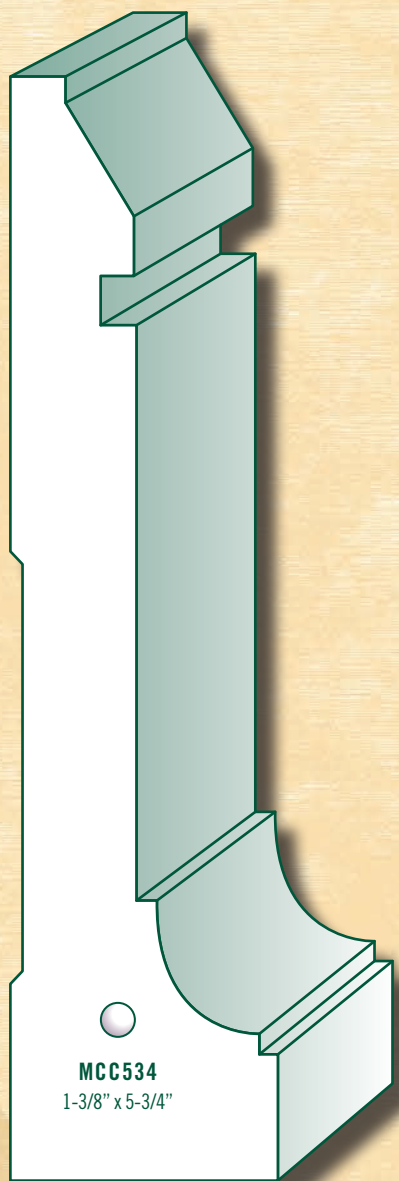

MCC534
1-3/8" x 5-3/4"



MCC575

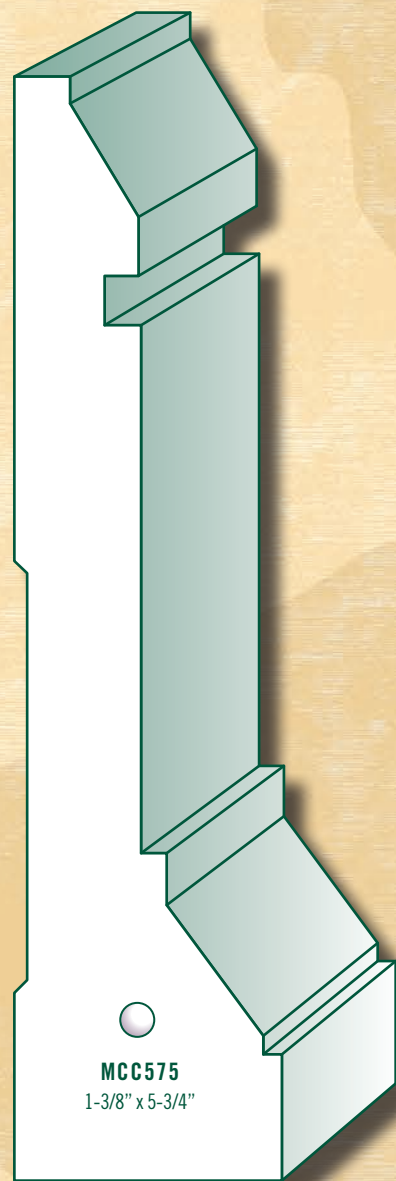

MCC575
1-3/8" x 5-3/4"



PL458, PLB9, PB518



All profiles are available in select hardwood species on a special order basis (see pages 127-133 for our hardwood moulding programs)

● PINE
 ● PRIMED
 ◆ OAK
 ◆ ULTRALITE MDF
 ▽ PRIMED POPLAR
 ▽ POPLAR
 ● PVC

ARCHITECTURAL accents

ROSETTES

Wellington



- WEL212 (1" x 2-1/2") ○
- WEL234 (1" x 2-3/4") ○◆
- WEL312 (1" x 3-1/2") ○◆
- WEL334 (1" x 3-3/4") ○◆
- WEL412 (1" x 4-1/2") ○◆
- WEL500 (1-5/16" x 5") ▼
- WEL834 (1-1/4" x 3-3/4") ○
- WEL414 (1-1/4" x 4-1/4") ○
- WEL512 (1-1/4" x 5-1/2") ○

Lexington (daisy)



- LEX312 (7/8" x 3-1/2") ○◆
- LEX412 (7/8" x 4-1/2") ○

KEYSTONES



- KEY312 (1" x 3-1/2") ○
- KEY412 (1" x 4-1/2") ○
- KEY512 (1" x 5-1/2") ○

Cambridge



- CAM312 (1" x 3-1/2") ○◆
- CAM334 (1" x 3-3/4") ○◆
- CAM834 (1-1/4" x 3-3/4") ○
- CAM434 (1" x 4-3/4") ○
- CAM512 (1-1/4" x 5-1/2") ○
- CAM712 (1-1/4" x 7-1/2") ○

Pilaster



- PPB512 (1-1/8" x 5-1/2" x 8") ○
- PPB712 (1-1/8" x 7-1/2" x 8") ○

Wellington



- WPB334 (1" x 3-3/4" x 6") ○

ARCH ROSETTES



- WA234 (1" x 2-3/4" x 4-1/2") ○
- WA334 (1" x 3-3/4" x 6") ○
- WA834 (1-5/16" x 3-3/4" x 7") ▼

PLINTH BLOCKS

Pilaster

Bridgeford



- BRI234 (1" x 2-3/4" x 6") ○◆
- BRI312 (1" x 3-1/2" x 6") ○◆
- BRI334 (1" x 3-3/4" x 6") ○◆
- BRI833 (1-1/8" x 4-1/2" x 8") ○
- BRI434 (1" x 4-3/4" x 6") ○

Rosettes and plinth blocks can be special ordered in any size, shape or species (minimum quantities apply)

CROWNS/COVES HEIGHTS & PROJECTIONS



UC71 Crown & PLB612



PLC812 & CB312



GSC614 & GSB412 (ceiling and wall)



GSC512 & GSB412 (ceiling and wall)



UC71 Crown & BB6 Base



UC51 Crown & BB7 Base



UC41 Crown & ES3 Casing



UC31 Crown & BB458 Base

SKU#	HEIGHT	PROJECTION
Primed Pine Crowns/Coves		
L8010	2	1-3/8
WM53	2	1-3/16
L8009	2-1/2	2-5/16
COV312	2-1/2	2-1/2
LWM49	2-15/16	2-1/8
UC31	2-1/2	2-5/8
L8013	3-1/2	2-5/8
8013*	3-1/2	2-1/2
COV412	3-1/4	3-1/8
LWM47	3-5/8	2-3/4
WM47	3-5/8	2-5/8
UC41	3-1/4	3-1/8
8027	3-7/8	3-1/8
SBC514	3-7/8	3-7/8
BC5	3-1/2	3-3/4
UC51	3-7/8	3-3/4
UC71	5-1/4	5-1/8
COV7	5-1/4	5-1/4
DTL512	4-1/4	3-7/16
DTL334	3-1/16	2-5/16
Prestige Line - MDF		
LWM49	2-3/4	2-1/2
UC31	2-7/8	2-1/4
GSC412	3-5/8	2-3/4
LWM47	3-1/4	3-1/4
UC41	3-1/4	3-5/16
8027	3-3/4	3-5/8
GSC512	3-15/16	3-15/16
UC51	4	4
GSC614	4-7/16	4-7/16
PLC99MDF	4-3/4	4-1/4
PLC612	4-1/2	4-5/8
PLC634	4-3/4	4-13/16
UC71	5-1/4	5
GSC738	5-7/16	5-1/16
PLC712	5-1/4	5-1/4
PLC812	6-1/8	5-7/8
PLC1012	7-1/2	8
The Metro Collection		
MCOV5	3	3
MCR514	3-7/8**	3-1/2**
MCR550	3-7/8	3-7/8
MCOV6	3-5/8	3-5/8
MCR650	4-5/8	4-5/8
MCR714	5-1/2**	4-5/8**
MCR750	5-1/4	5-1/4
MCOV8	5-1/16	5-1/16
The Designer Collection		
DCR512	3-7/8	4
DCR558	4	4
DCR612	4-3/4	4-1/2
DCR634	5-1/8	4-1/2
DCR725	5-1/8	5-1/4
DCR734	5-1/2	5-1/2
DCR814	5-1/2	6-1/8

*available in clear pine only **MCR514 and MCR714 reverse dimensions for wall step use

CROWNS/COVERS

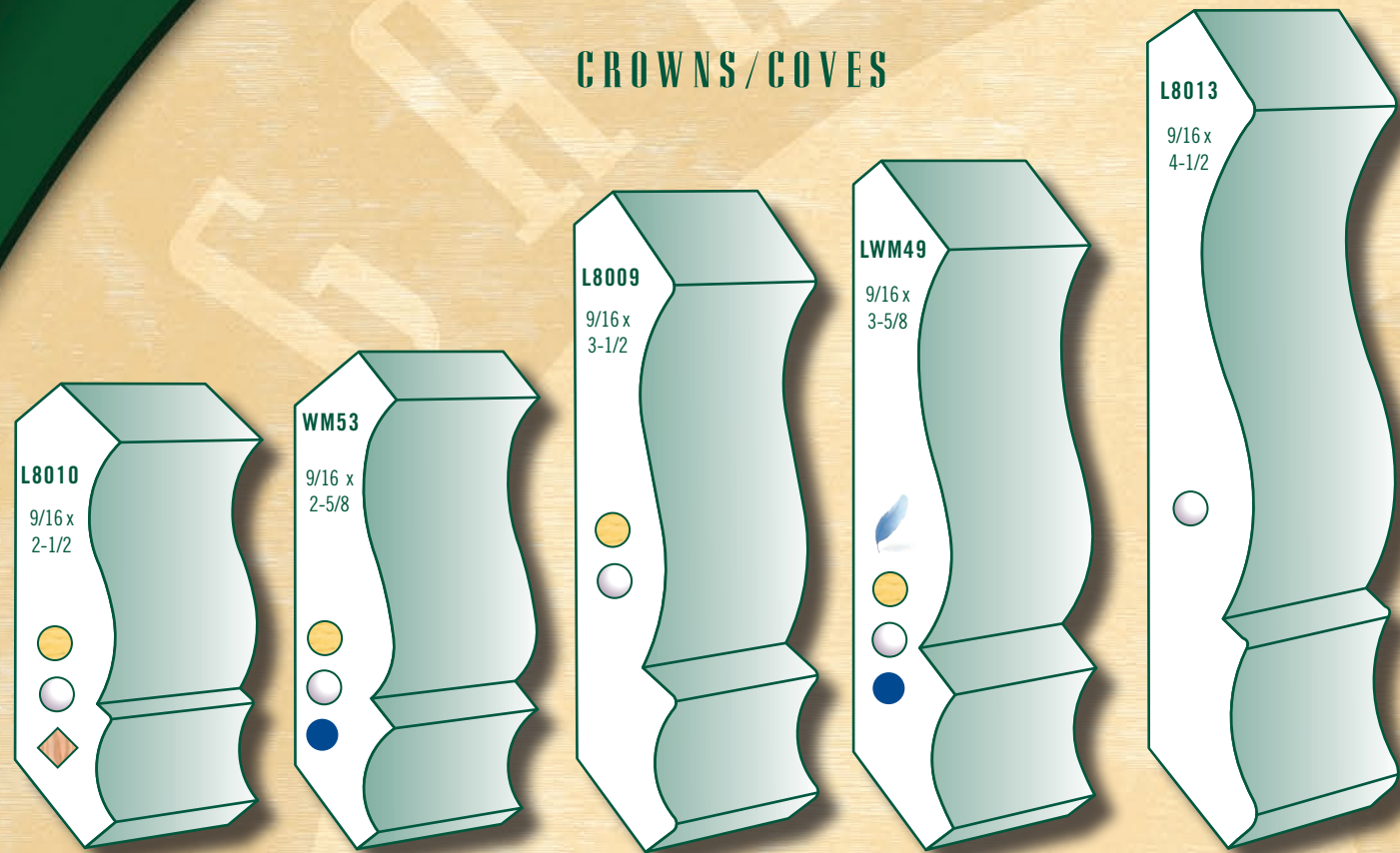

8027



CB312 and COV412



CB312 and UC31

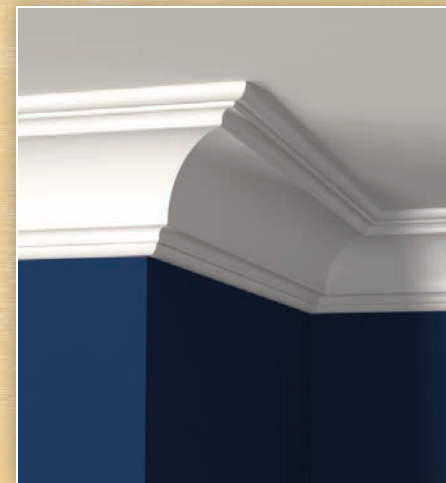

COV312



UC31



COV412

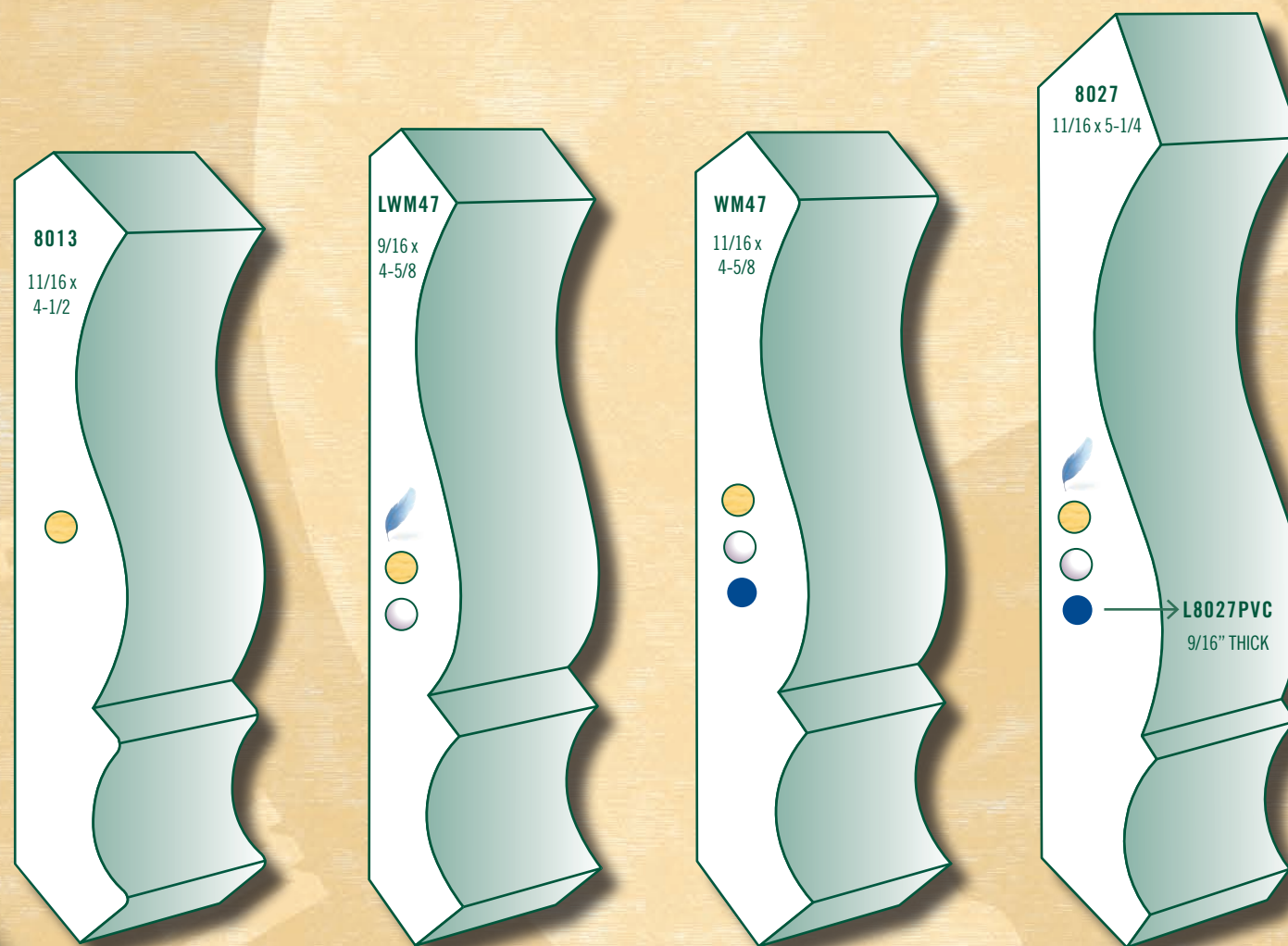

CROWN BACKER

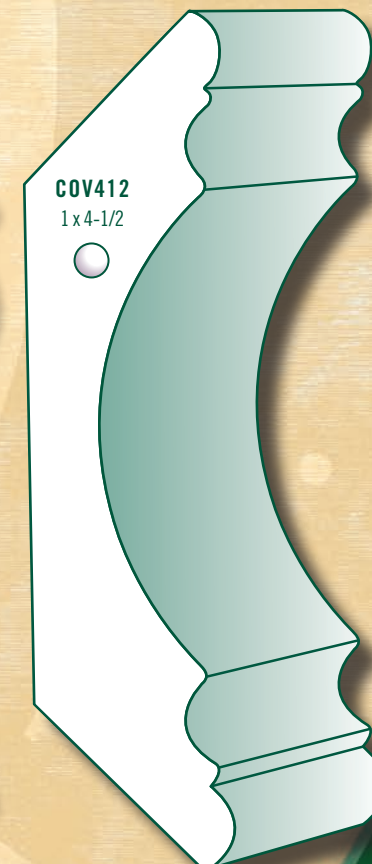
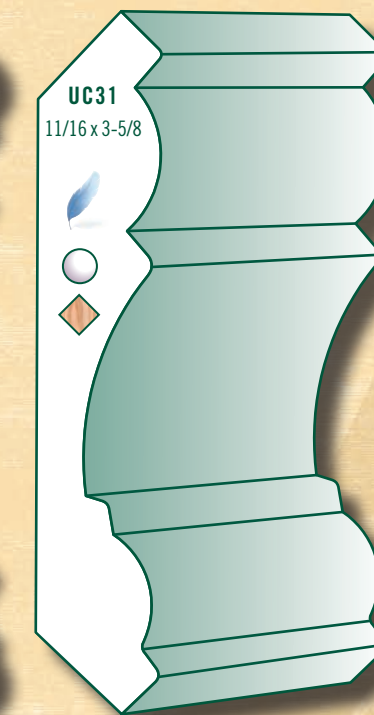
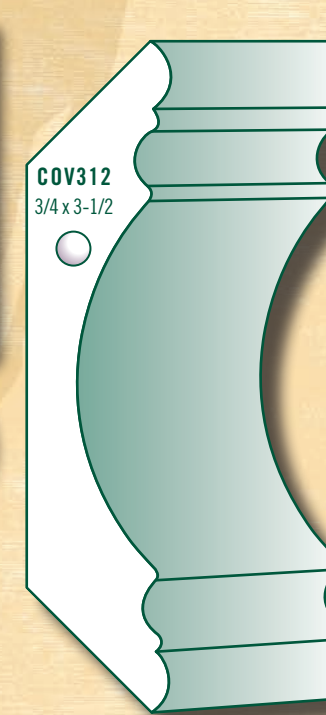
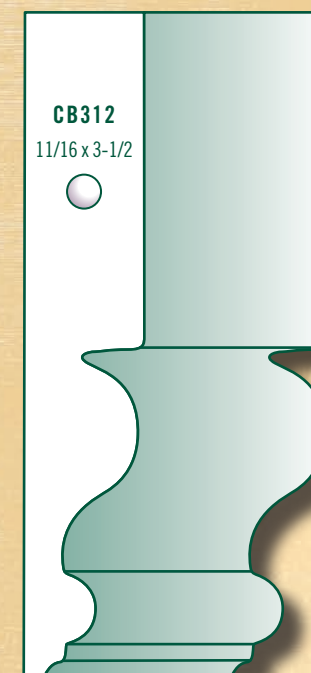

CROWNS/COVERS

All profiles are available in select hardwood species on a special order basis (see pages 127-133 for our hardwood moulding programs)

● PINE ○ PRIMED ◆ OAK ● ULTRALITE MDF ▼ PRIMED POPLAR ▼ POPLAR ● PVC

CROWNS/COVES

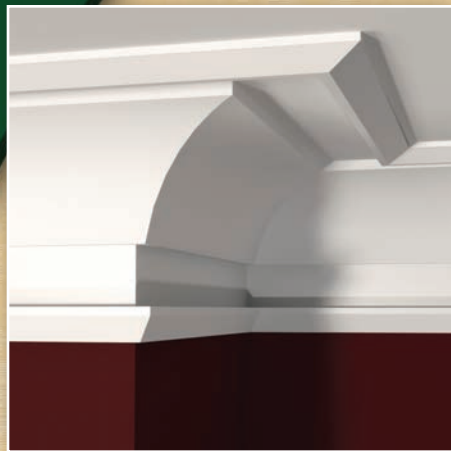

MCS1, MCOV5, MCS1

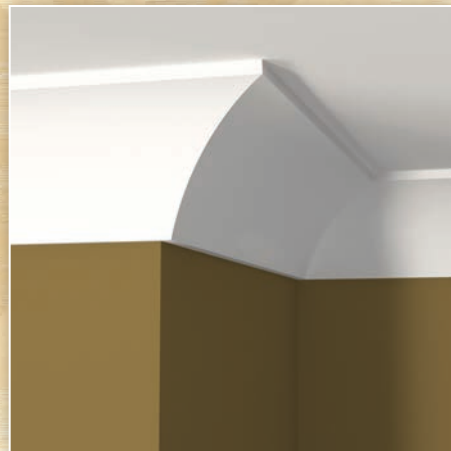
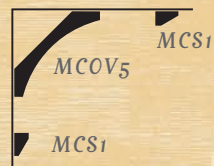

MCOV5



GSC412



UC41



BC5



SBC514

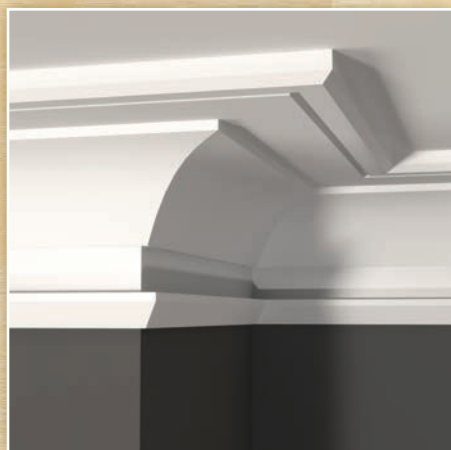

MCC412, MCOV5, MCS1

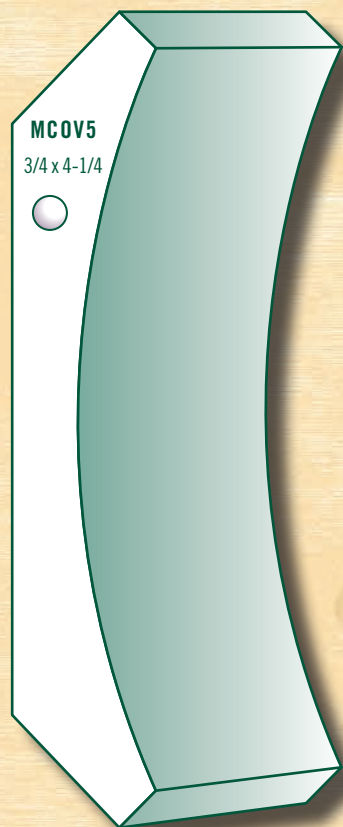
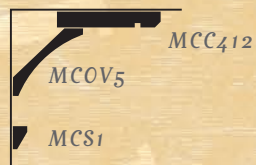

MCOV5
3/4 x 4-1/4

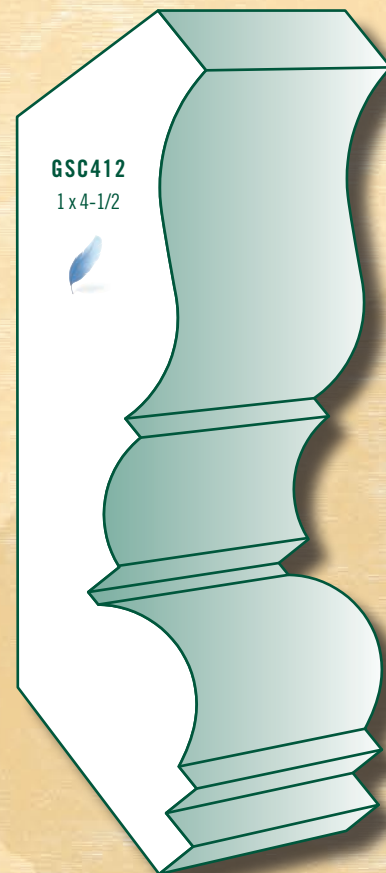

GSC412
1 x 4-1/2

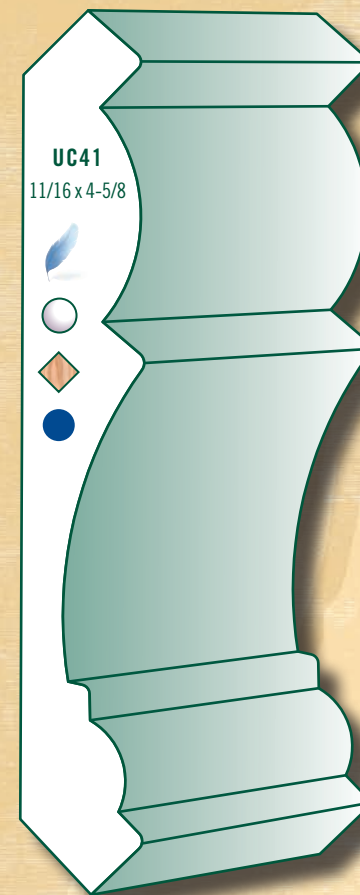

UC41
1 1/16 x 4-5/8

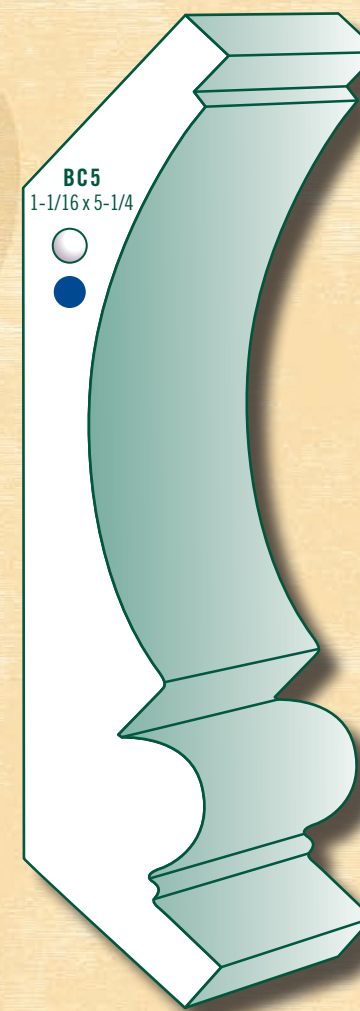

BC5
1-1/16 x 5-1/4

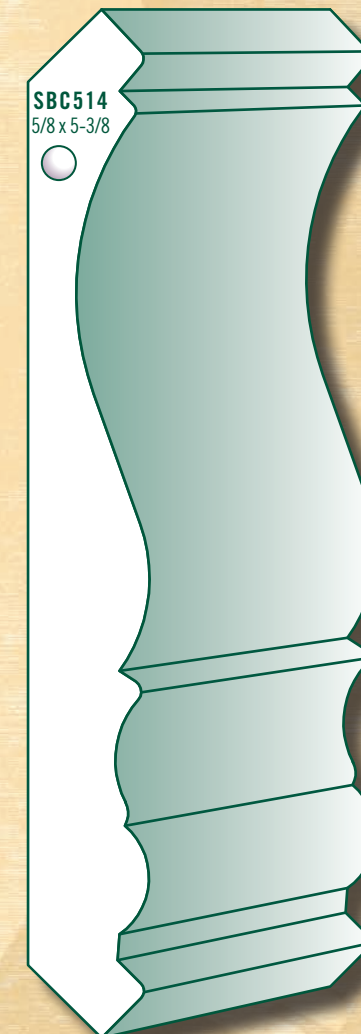

SBC514
5/8 x 5-3/8

THE METRO COLLECTION

All profiles are available in select hardwood species on a special order basis (see pages 127-133 for our hardwood moulding programs)

PINE
 PRIMED
 OAK
 ULTRALITE MDF
 PRIMED POPLAR
 POPLAR
 PVC

CROWNS/COVERS

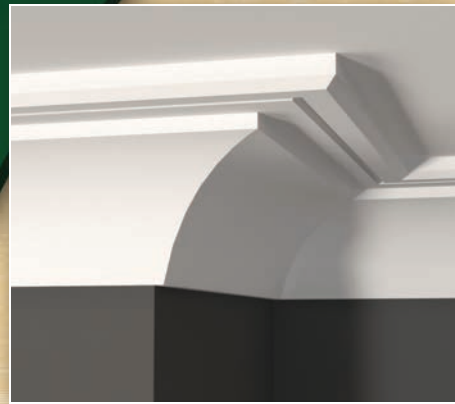

MCC312, MCOV6

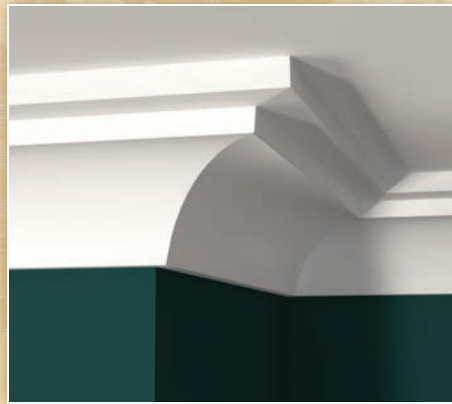
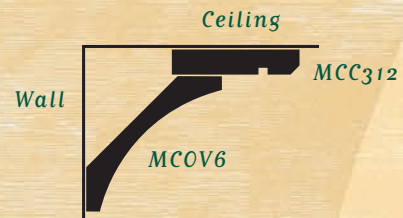

MCR514 Ceiling Step

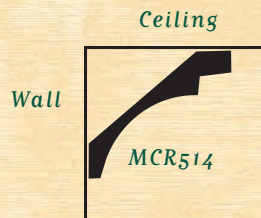

Projection: 3-7/8" Height: 3-1/2"



MCR514 Wall Step

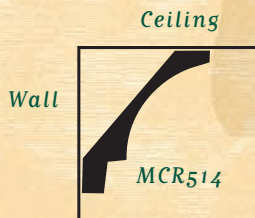

Projection: 3-1/2" Height: 3-7/8"



DCR512

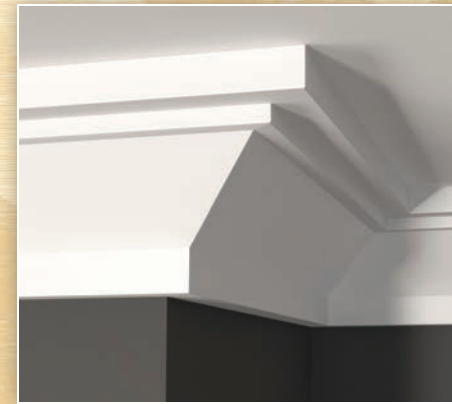

MCR550 Ceiling Step

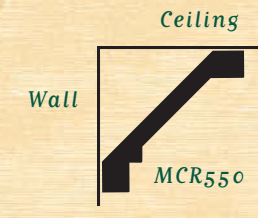

Projection: 3-7/8" Height: 3-7/8"



MCR550 Wall Step

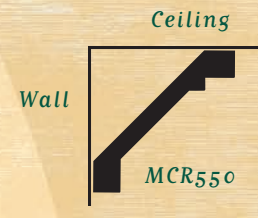

Projection: 3-7/8" Height: 3-7/8"



MCR514, MCC312

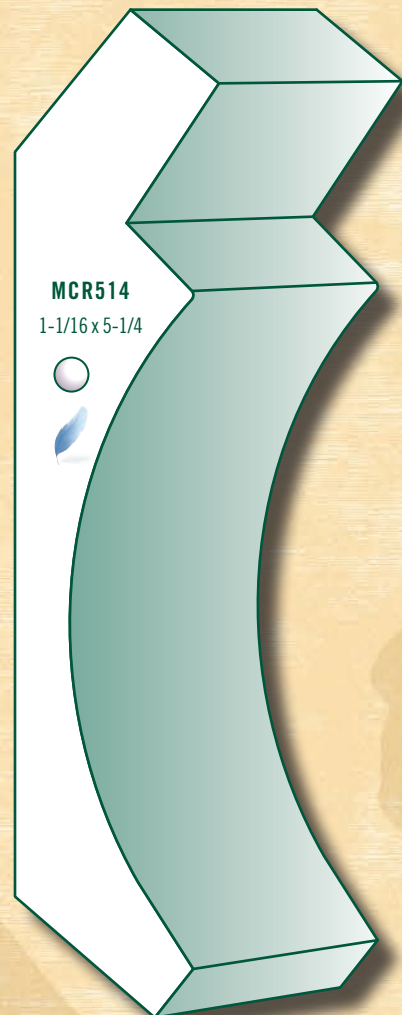
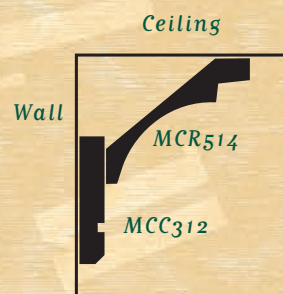

MCR514
1-1/16 x 5-1/4

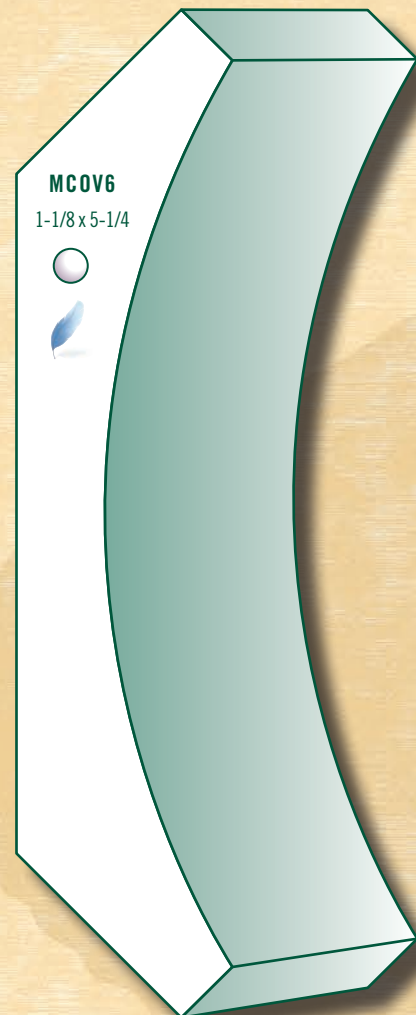

MCOV6
1-1/8 x 5-1/4



DCR512
13/16 x 5-1/2
18' Lengths

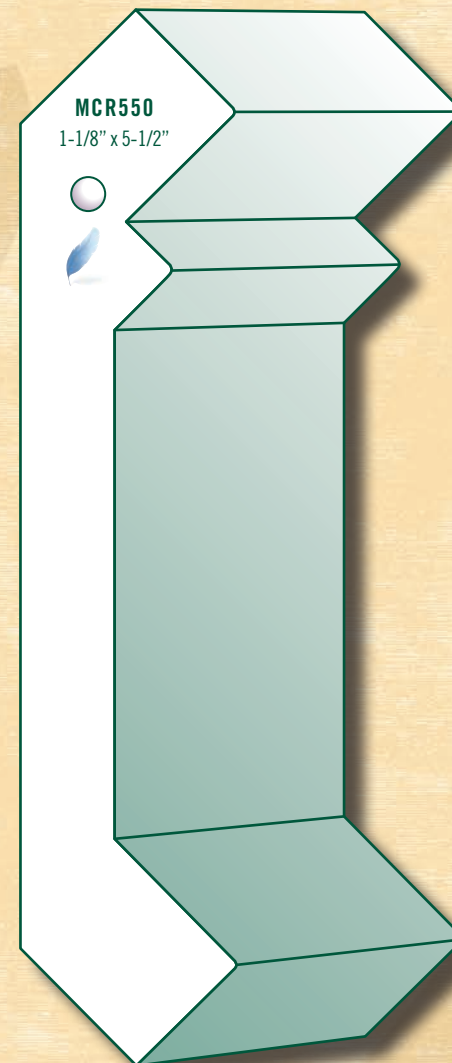

MCR550
1-1/8" x 5-1/2"



MCR550 MCAP1, MCC412

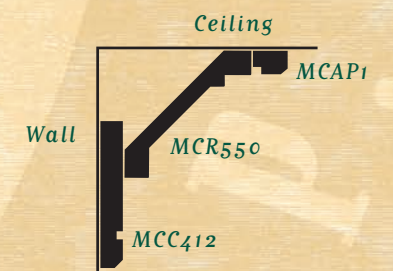

METRO
COLLECTION

METRO
COLLECTION

The Designer
COLLECTION

METRO
COLLECTION

● PINE
 ● PRIMED
 ◆ OAK
 ◆ ULTRALITE MDF
 ▽ PRIMED POPLAR
 ▽ POPLAR
 ● PVC

CROWNS/COVES



GSC512



UC51



DCR558



PLC99



GSC614



PLC612

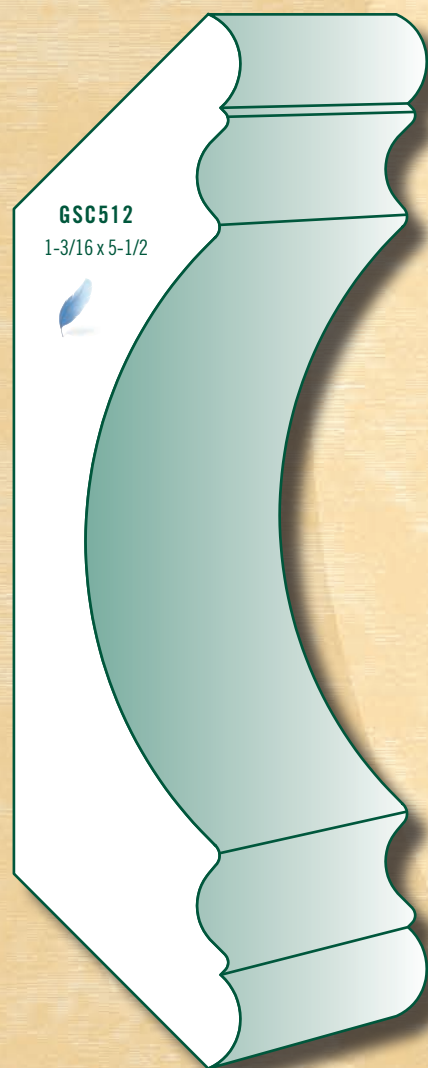

GSC512
1-3/16 x 5-1/2

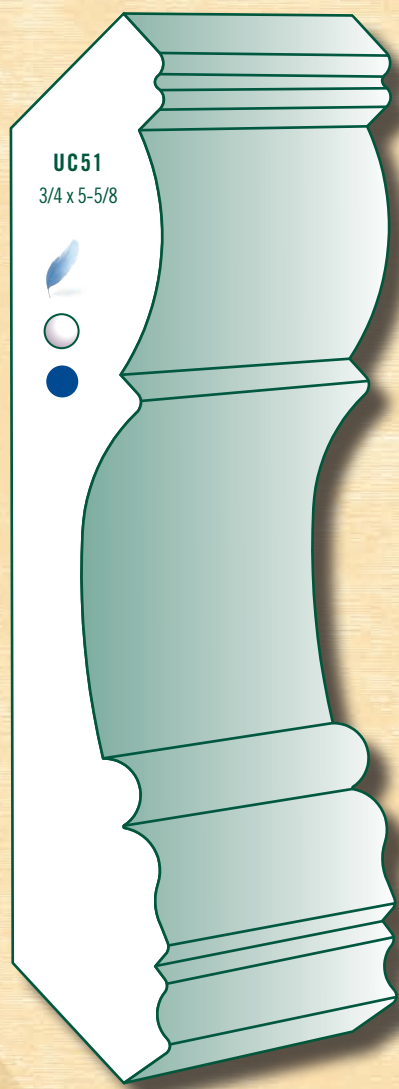

UC51
3/4 x 5-5/8

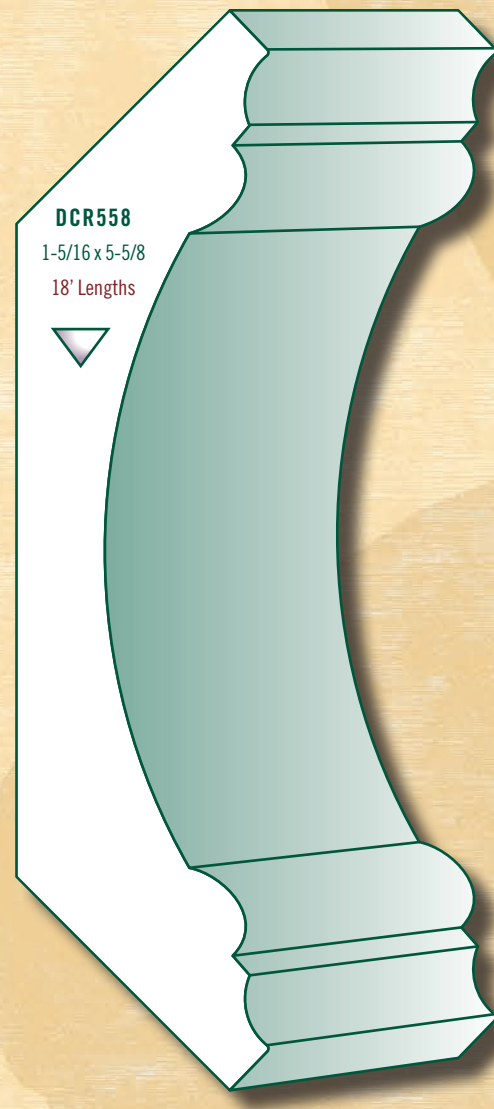

DCR558
1-5/16 x 5-5/8
18' Lengths

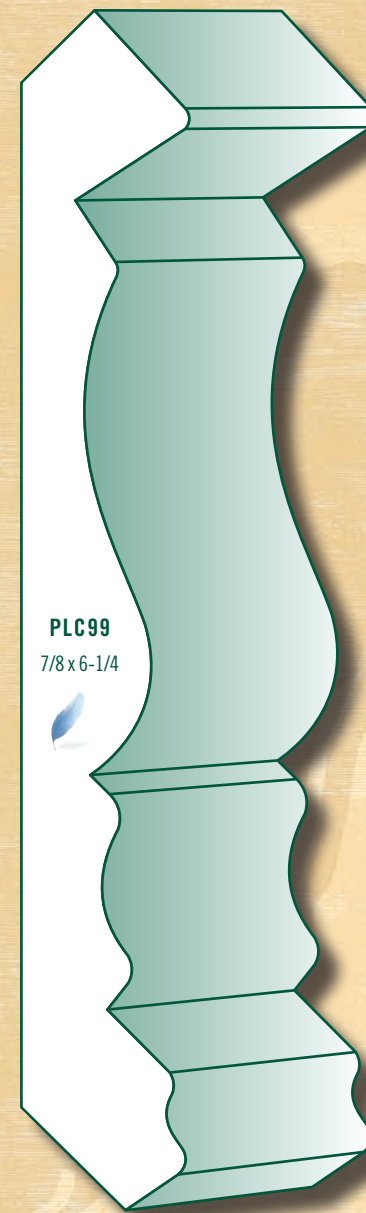

PLC99
7/8 x 6-1/4

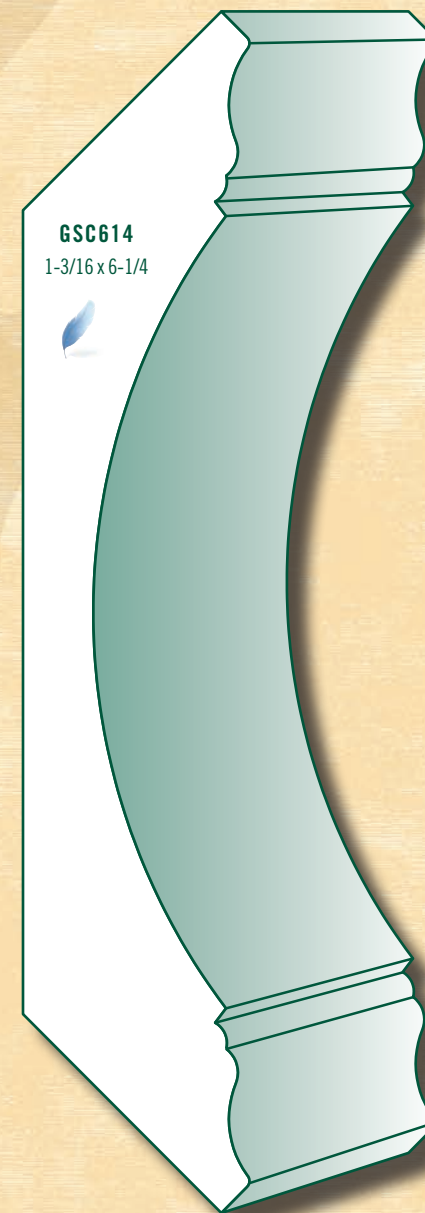

GSC614
1-3/16 x 6-1/4

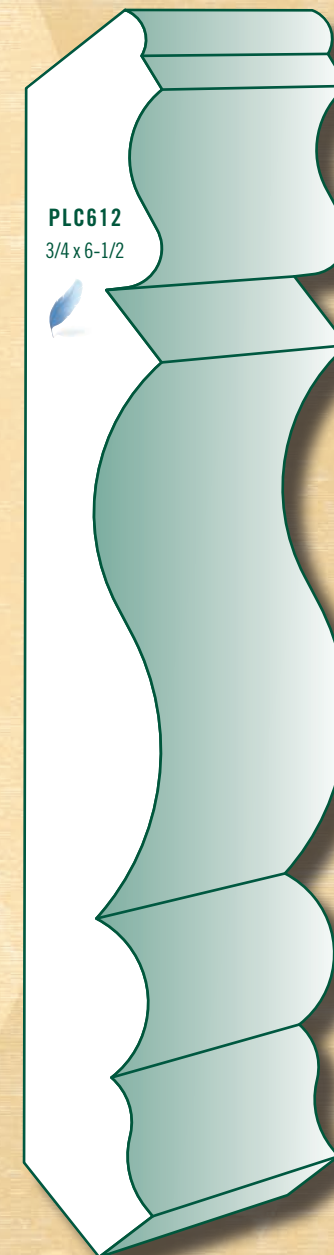

PLC612
3/4 x 6-1/2



The DESIGNER COLLECTION

All profiles are available in select hardwood species on a special order basis (see pages 127-133 for our hardwood moulding programs)

PINE
 PRIMED
 OAK
 ULTRALITE MDF
 PRIMED POPLAR
 POPLAR
 PVC



MCR650 Ceiling Step
Ceiling



Projection: 4-5/8" Height: 4-5/8"



MCR650 Wall Step
Ceiling



Projection: 4-5/8" Height: 4-5/8"



DCR612



PLC634



DCR634



UC71

CROWNS/COVES

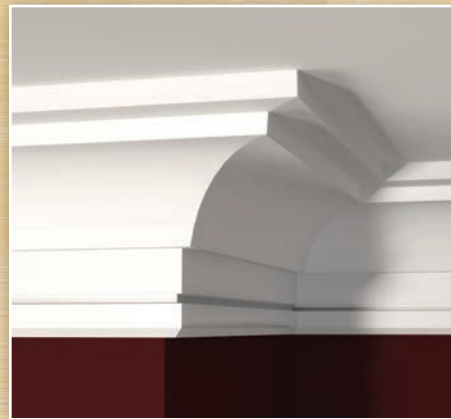

MCR514, MCC312

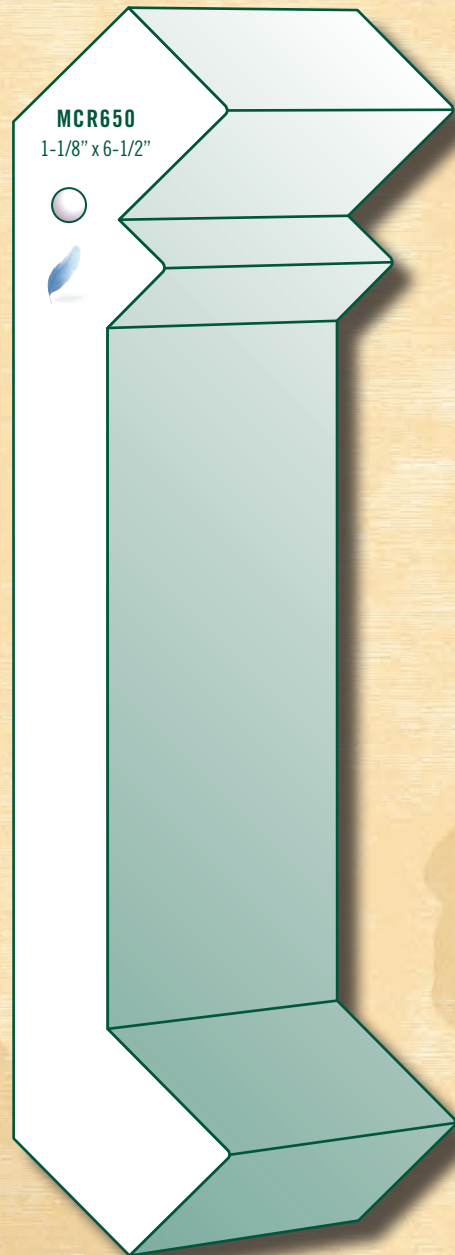
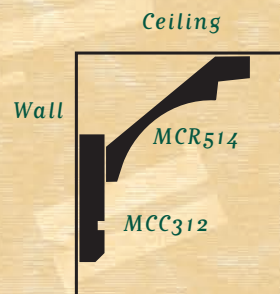

MCR650
1-1/8" x 6-1/2"

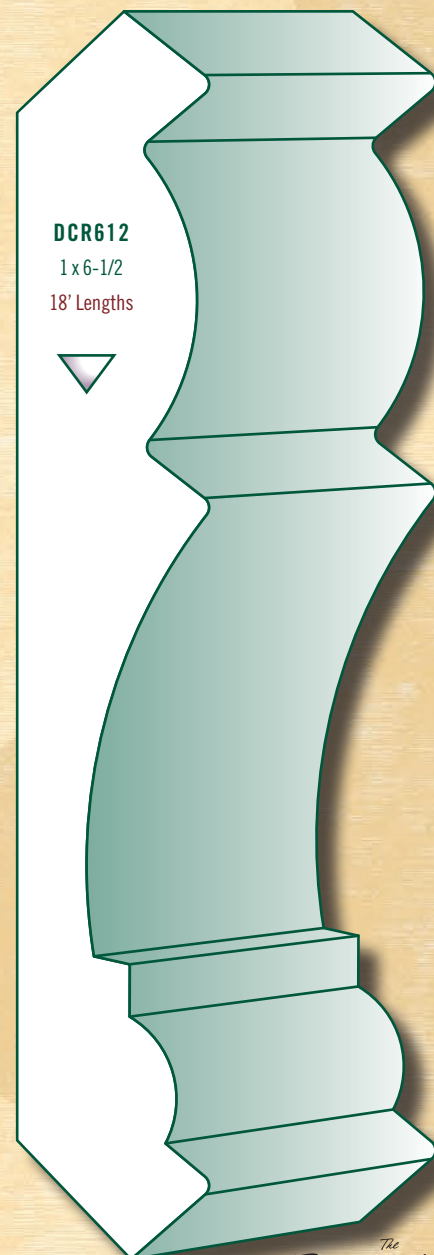

DCR612
1 x 6-1/2
18' Lengths

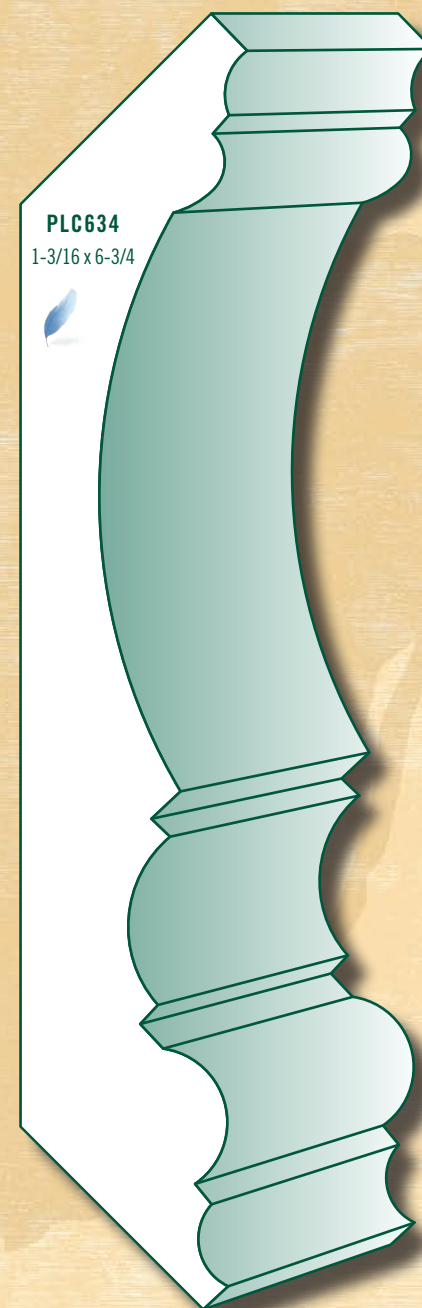

PLC634
1-3/16 x 6-3/4

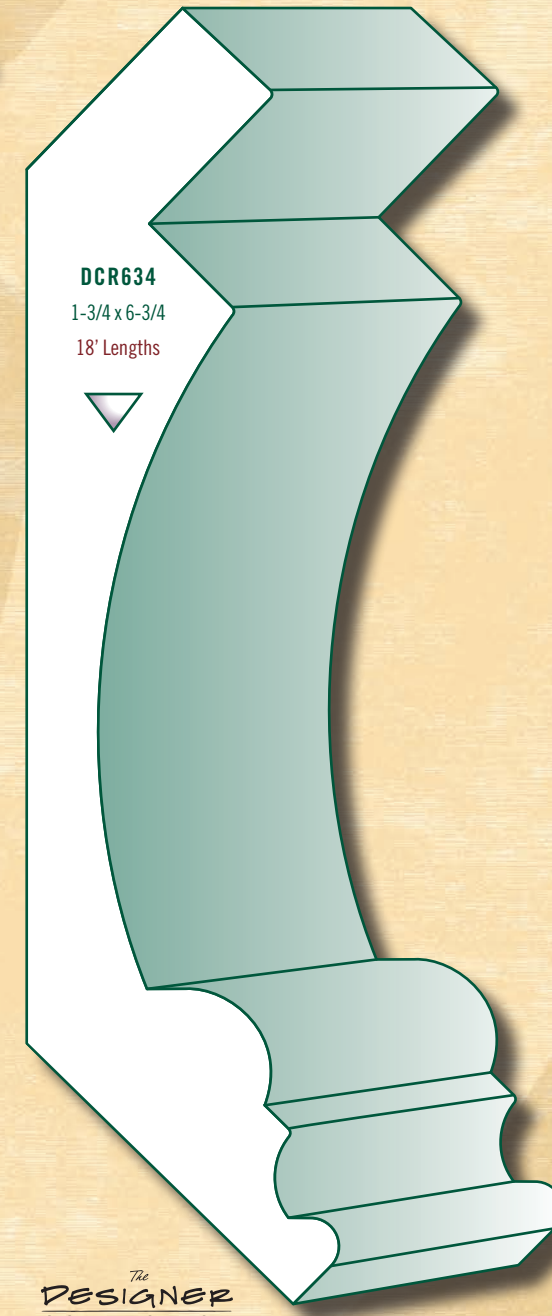

DCR634
1-3/4 x 6-3/4
18' Lengths

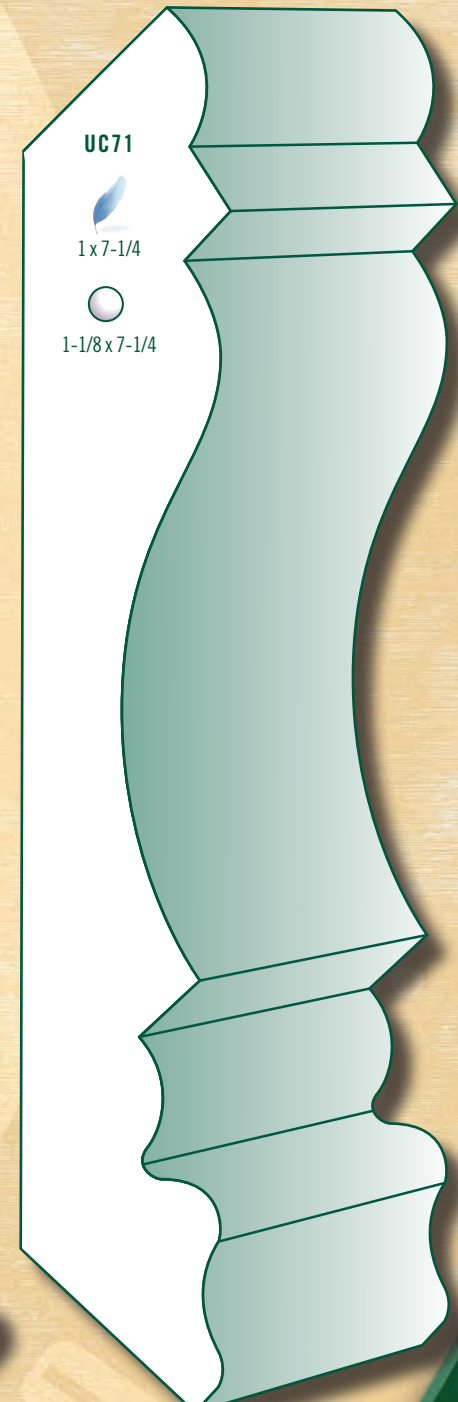

UC71



1-1/8 x 7-1/4



MCR714 Ceiling Step



MCOV8



COV7



DCR725



GSC738

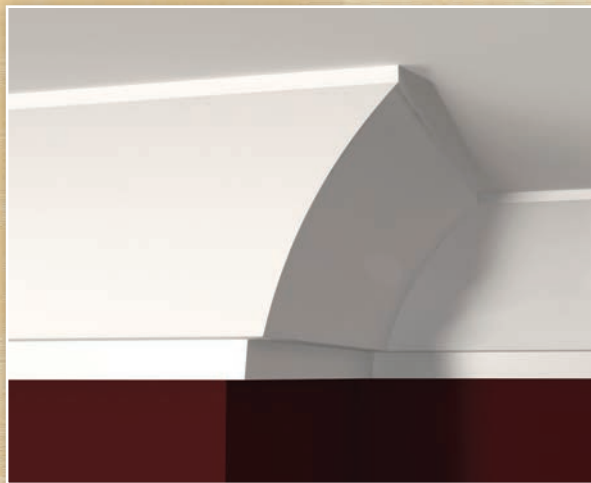
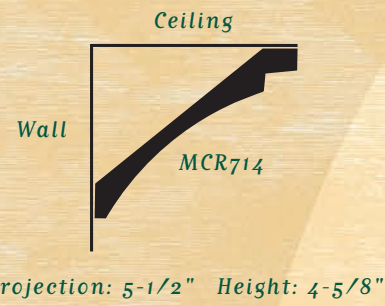

MCR714 Wall Step

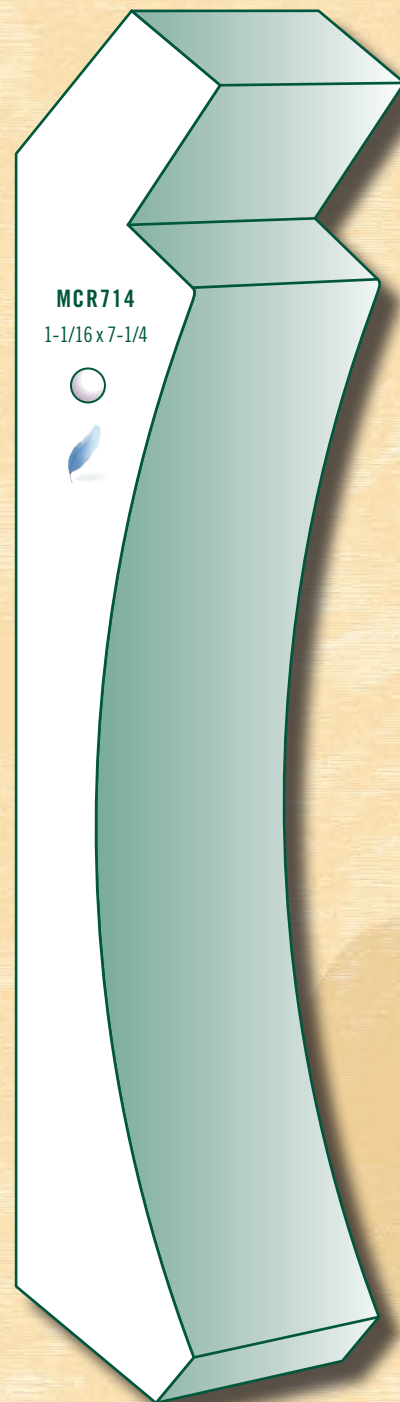
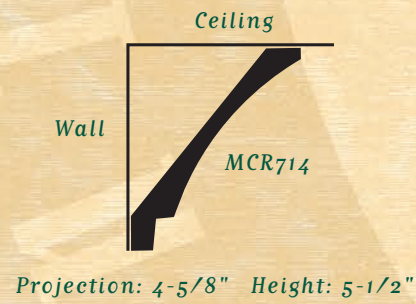

MCR714
1-1/16 x 7-1/4



MCOV8
1-1/8 x 7-1/4

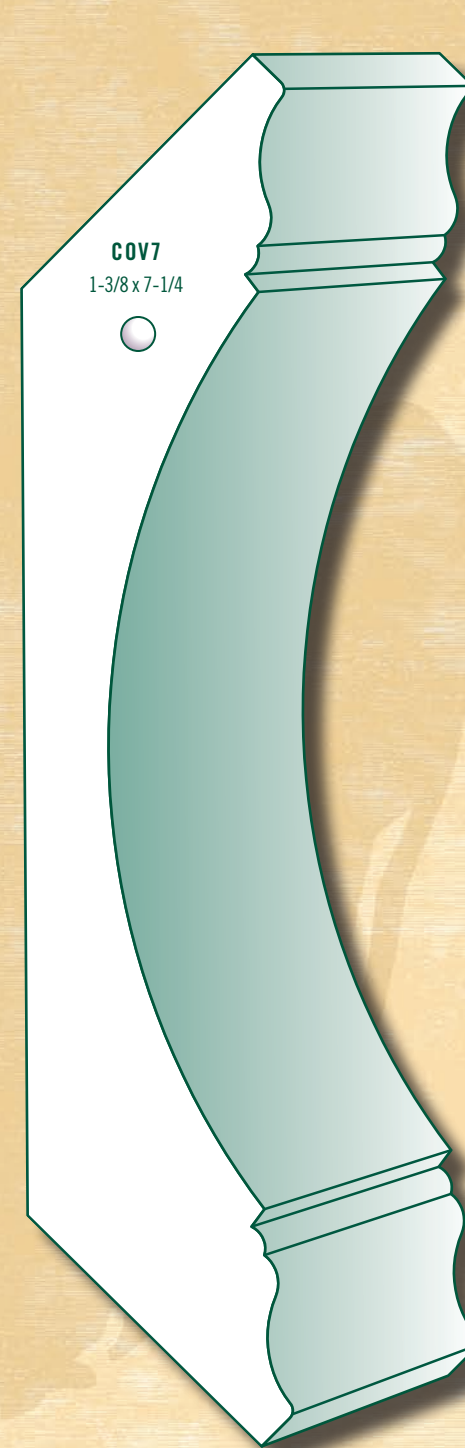

COV7
1-3/8 x 7-1/4

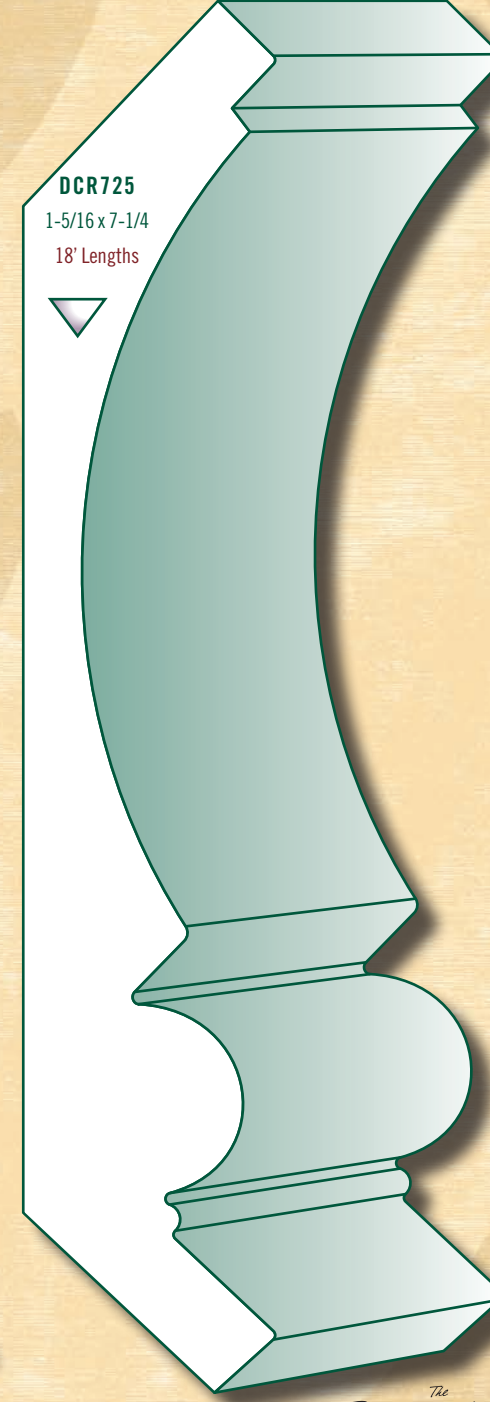

DCR725
1-5/16 x 7-1/4
18' Lengths

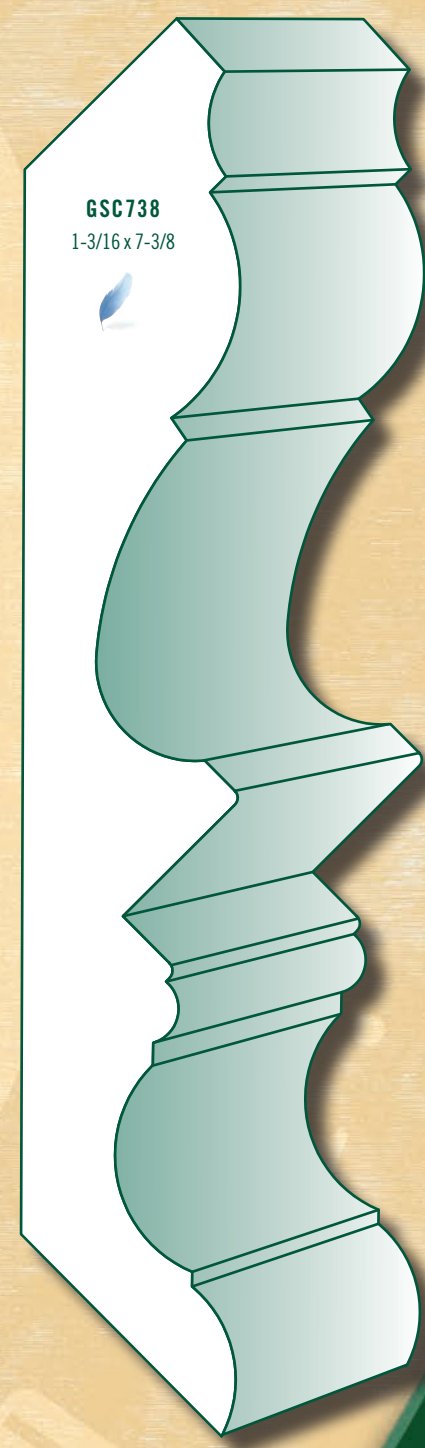

GSC738
1-3/16 x 7-3/8



METRO COLLECTION

METRO COLLECTION

The DESIGNER COLLECTION



MCR750 Ceiling Step
Ceiling



MCR750 Step on Wall, MCAP34



PLC712



DCR734



DCR814



Projection: 4-5/8" Height: 4-5/8"

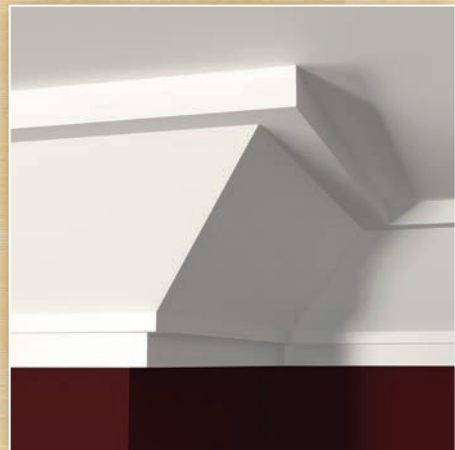

MCR750 Wall Step
Ceiling



Projection: 4-5/8" Height: 4-5/8"

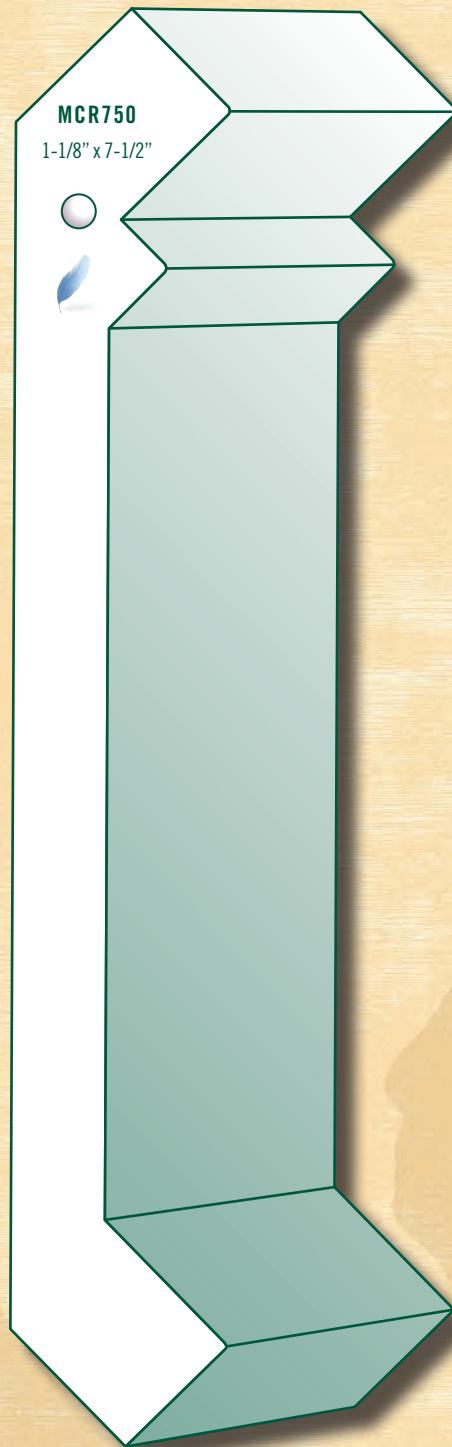

MCR750
1-1/8" x 7-1/2"

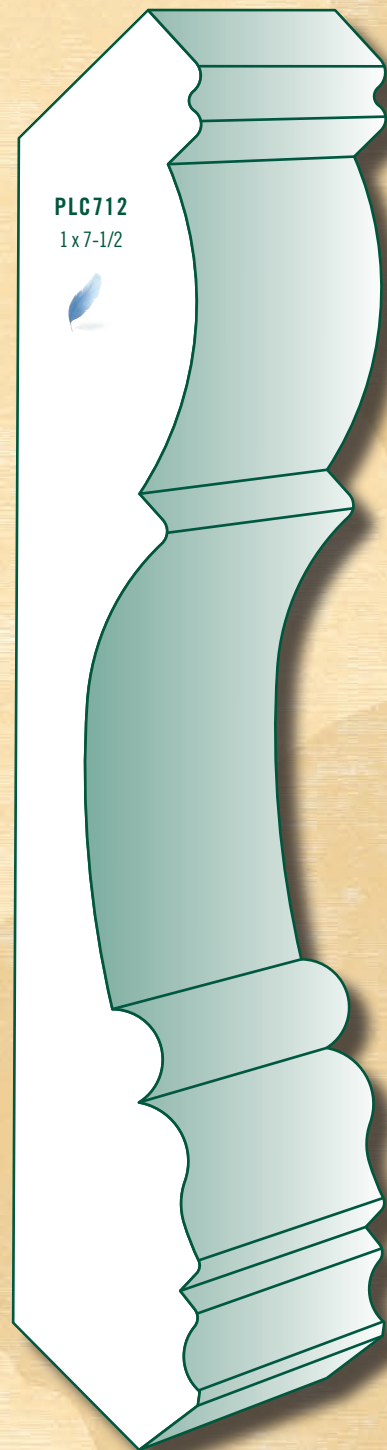

PLC712
1 x 7-1/2"

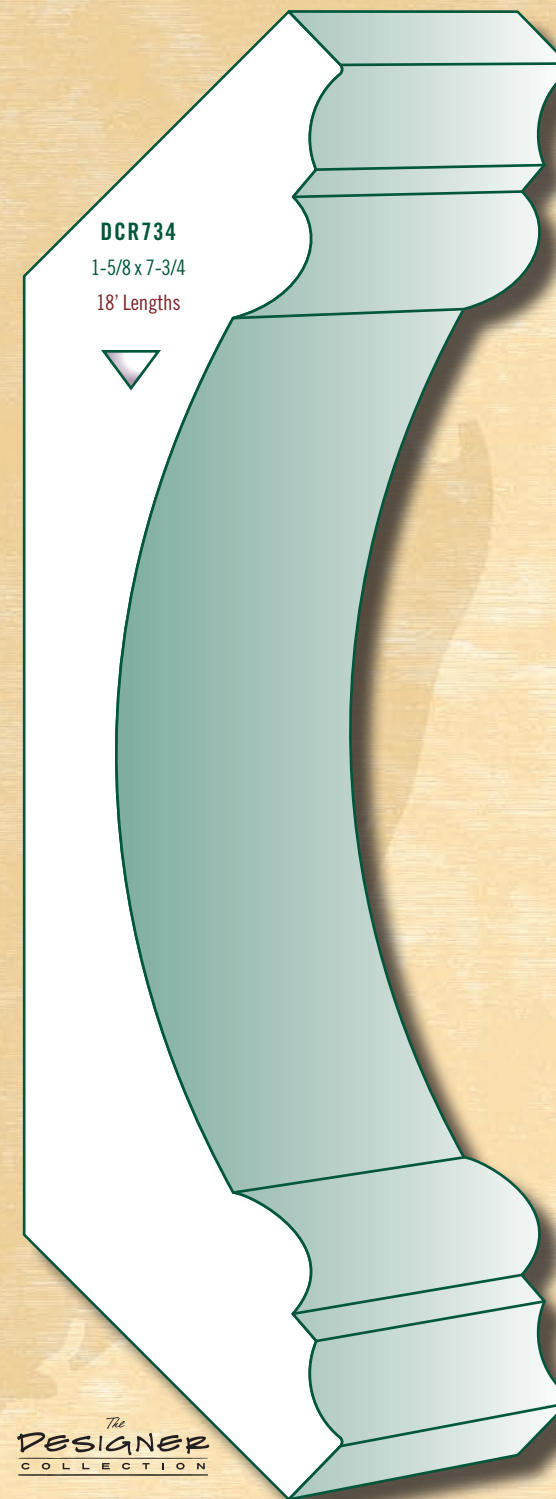

DCR734
1-5/8" x 7-3/4"
18' Lengths

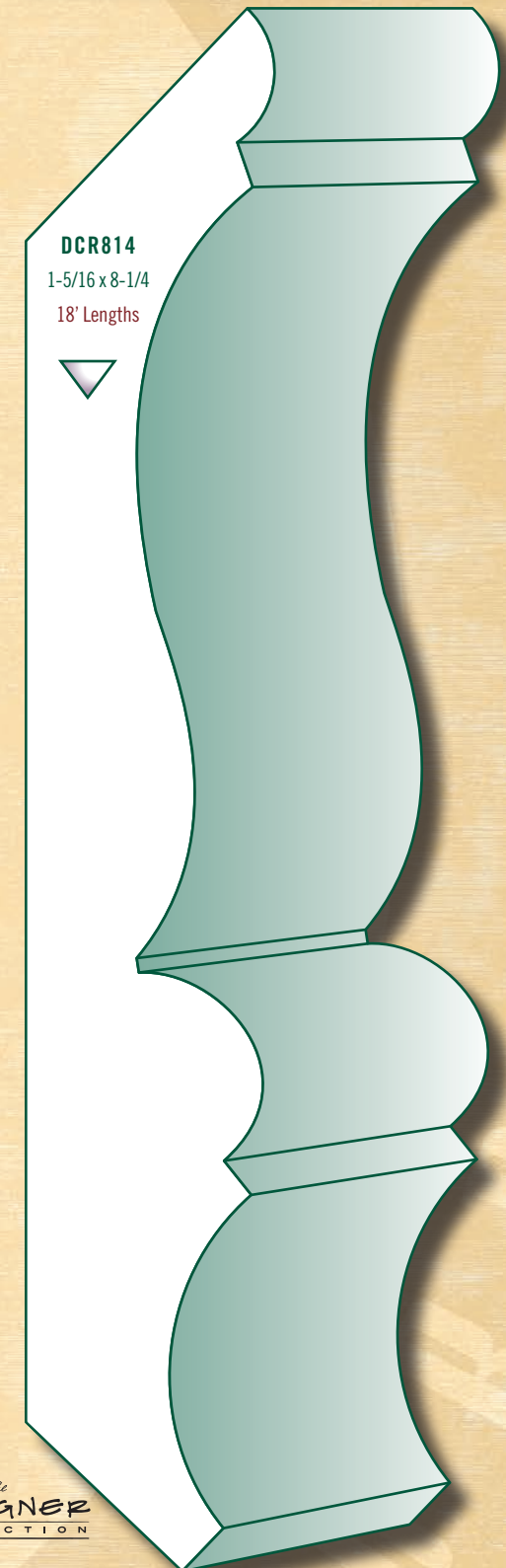

DCR814
1-5/16" x 8-1/4"
18' Lengths



METRO COLLECTION

The DESIGNER COLLECTION

The DESIGNER COLLECTION



CROWNS/COVERS

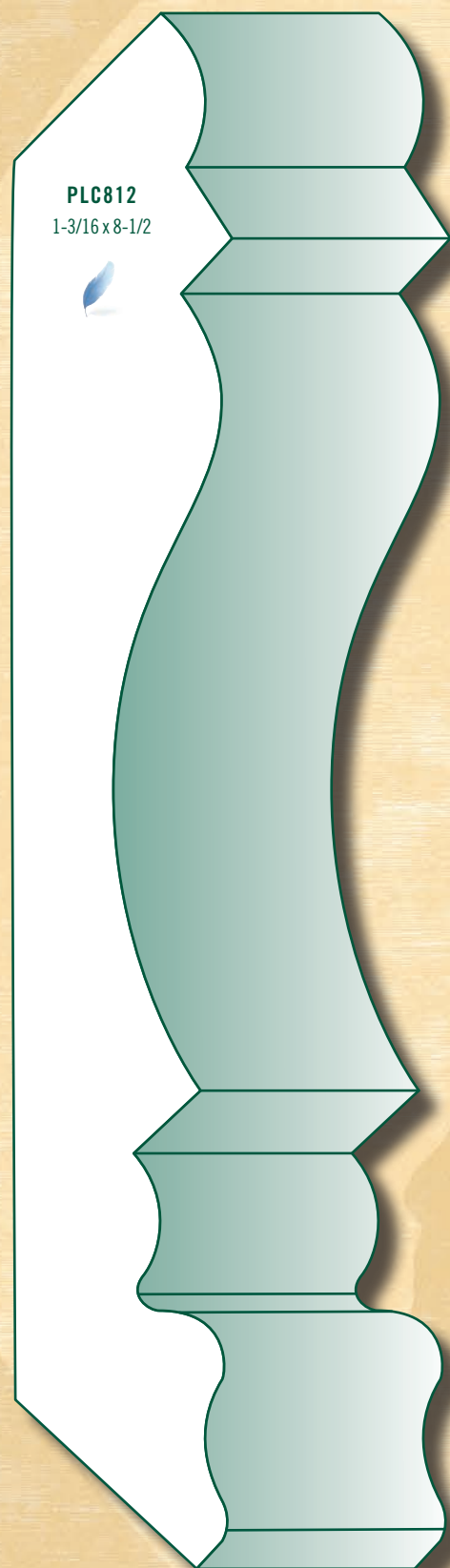

PLC812
1-3/16 x 8-1/2

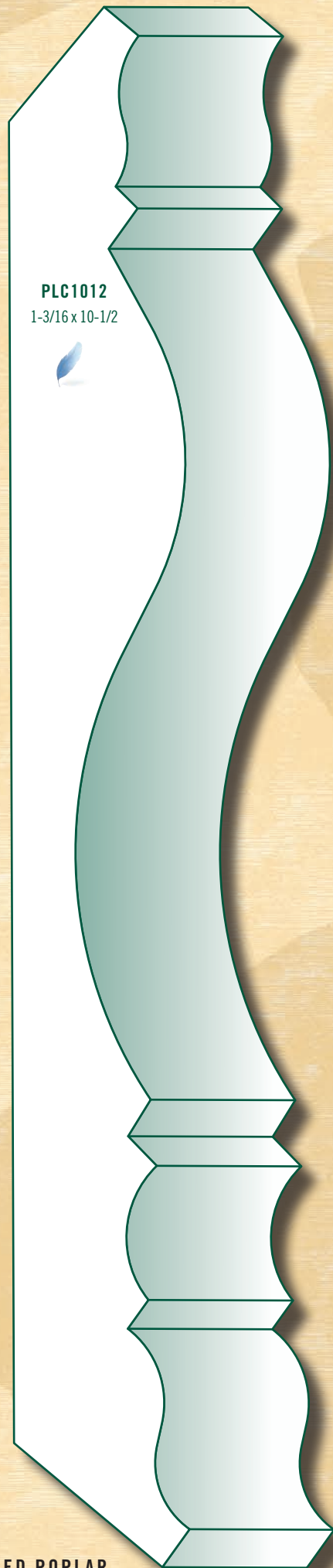

PLC1012
1-3/16 x 10-1/2

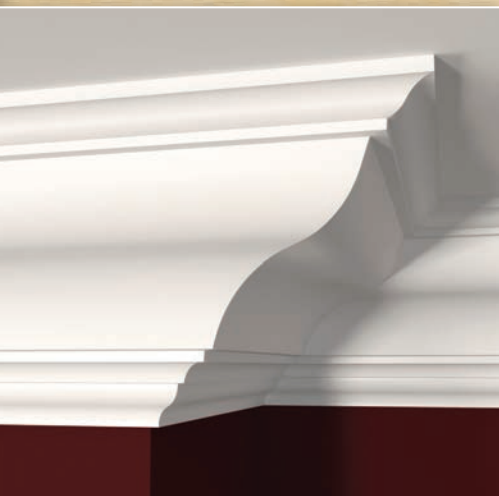

PLC1012



PLC812

BED MOULDINGS

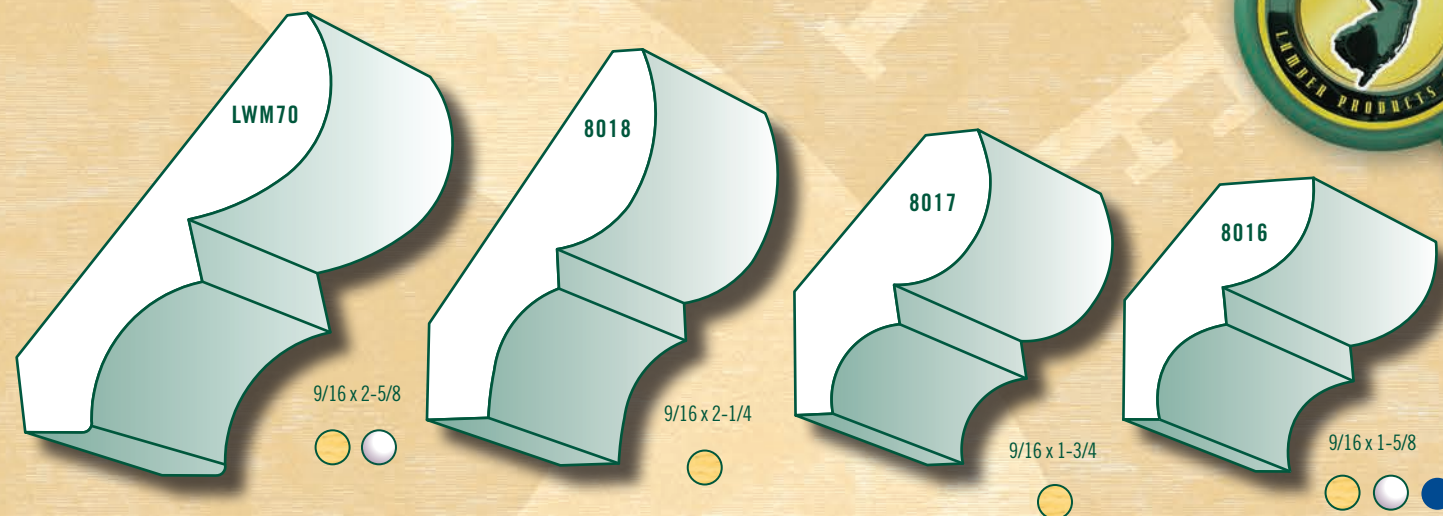

LWM70

9/16 x 2-5/8



8018

9/16 x 2-1/4



8017

9/16 x 1-3/4



8016

9/16 x 1-5/8



COVERS - BEADED

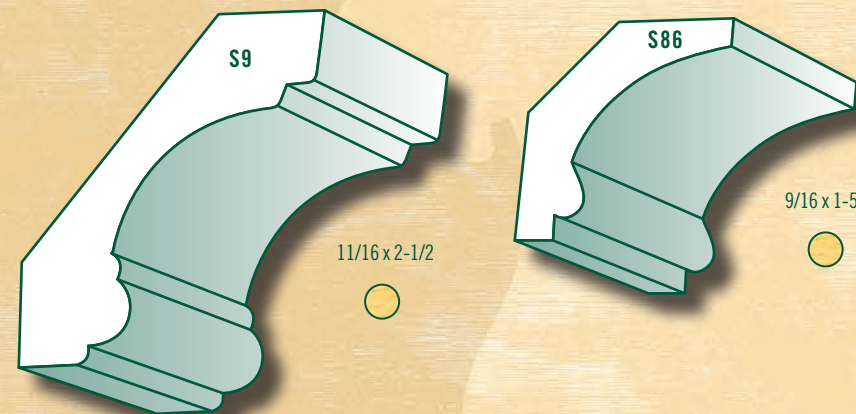

S9

11/16 x 2-1/2



S86

9/16 x 1-5/8



COVE MOULDINGS

INSIDE CORNER

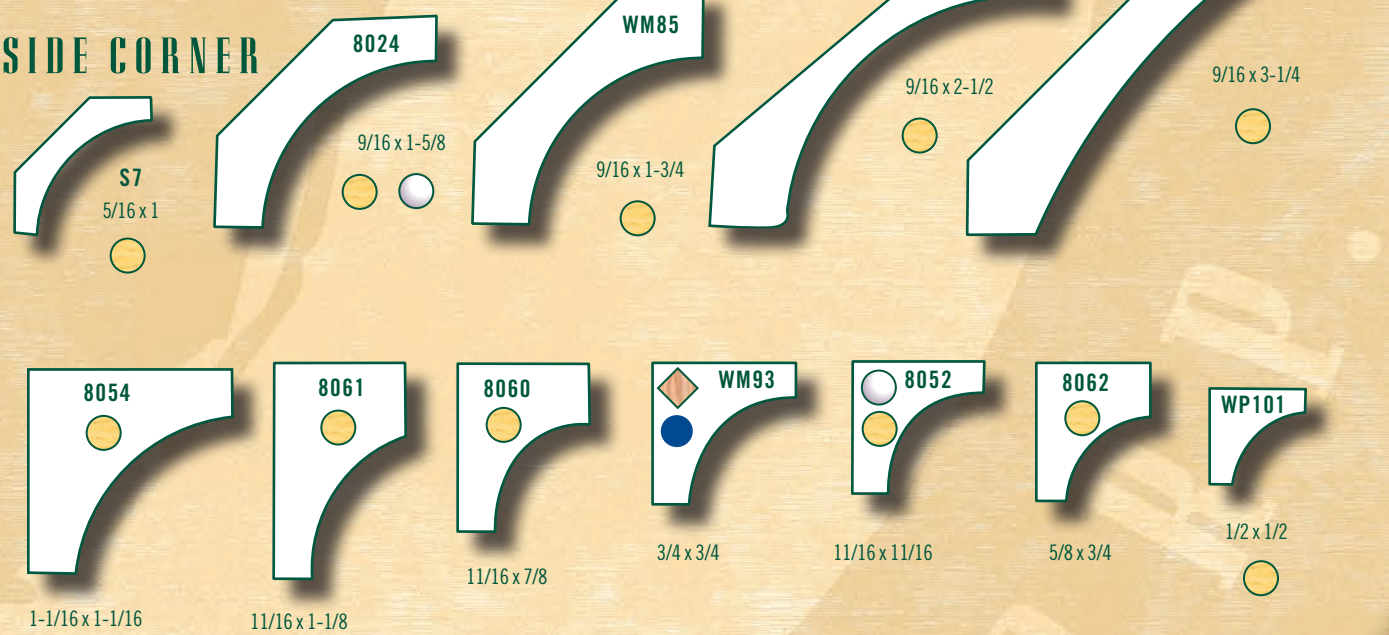

S7

5/16 x 1



8024

9/16 x 1-5/8



WM85

9/16 x 1-3/4



8026

9/16 x 2-1/2



WM81

9/16 x 3-1/4



8054

1-1/16 x 1-1/16



8061

11/16 x 1-1/8



8060

11/16 x 7/8



WM93

3/4 x 3/4



8052

11/16 x 11/16



8062

5/8 x 3/4



WP101

1/2 x 1/2



CROWNS - SOLID

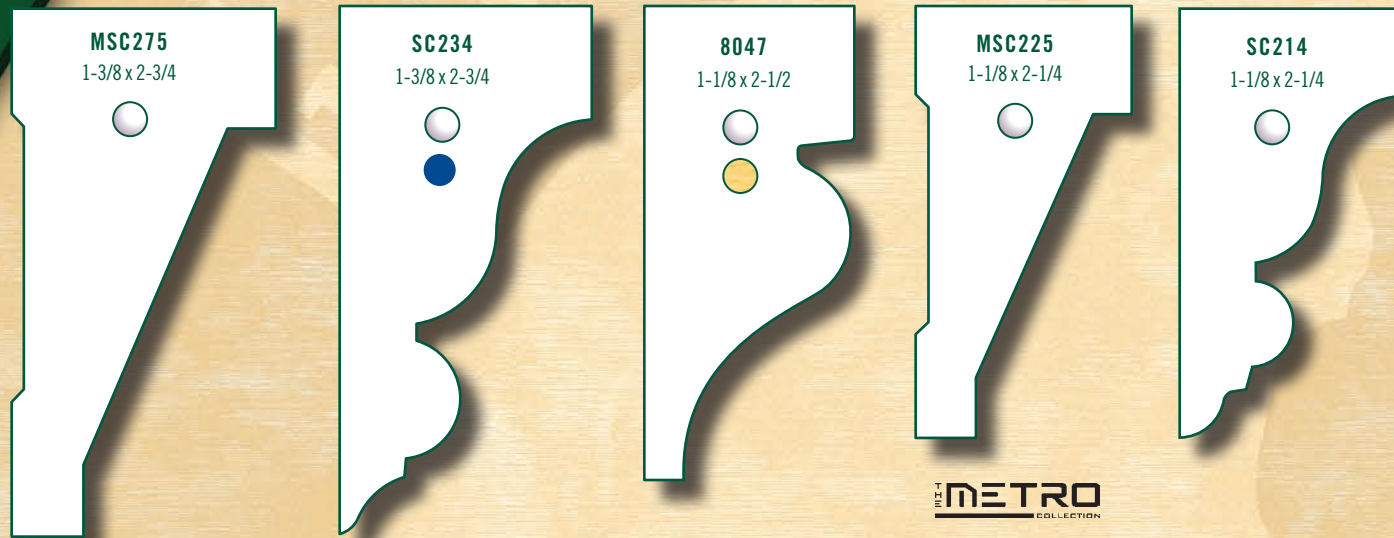

THE METRO COLLECTION

THE METRO COLLECTION

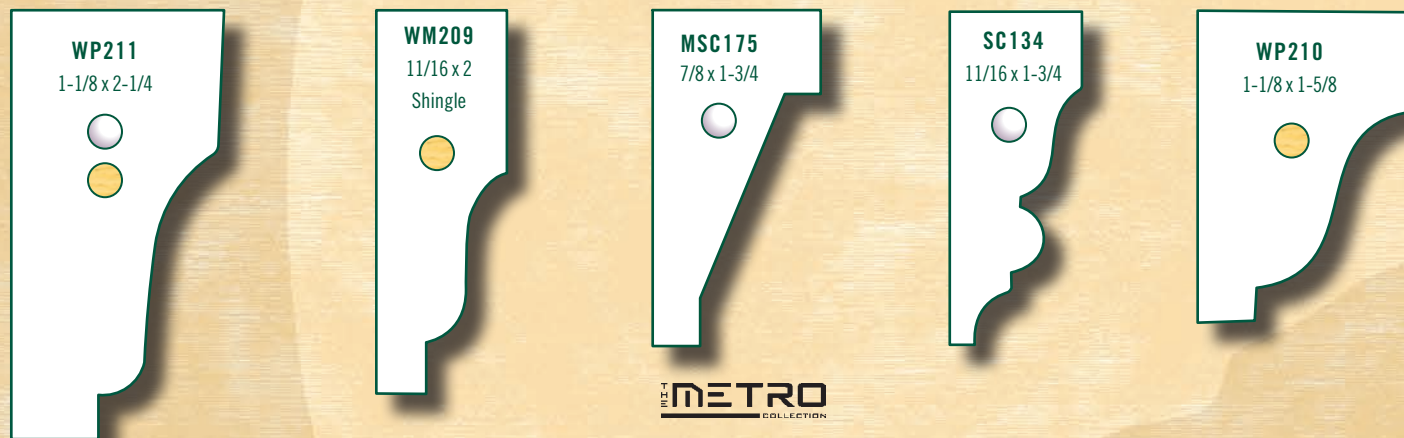
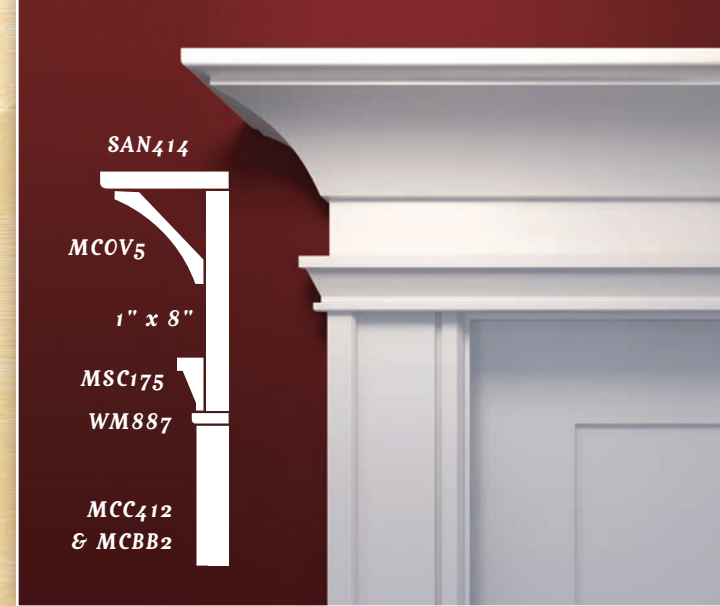

THE METRO COLLECTION

NECK MOULDINGS

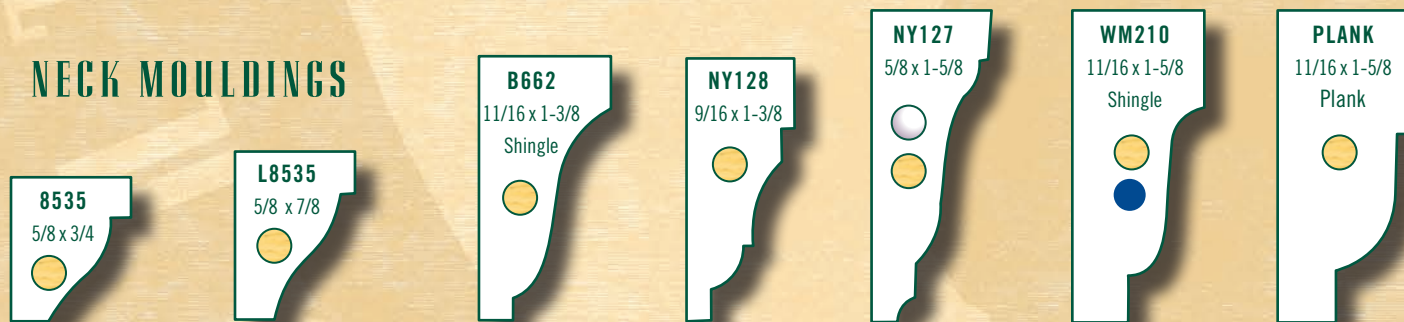

DENTIL CROWNS

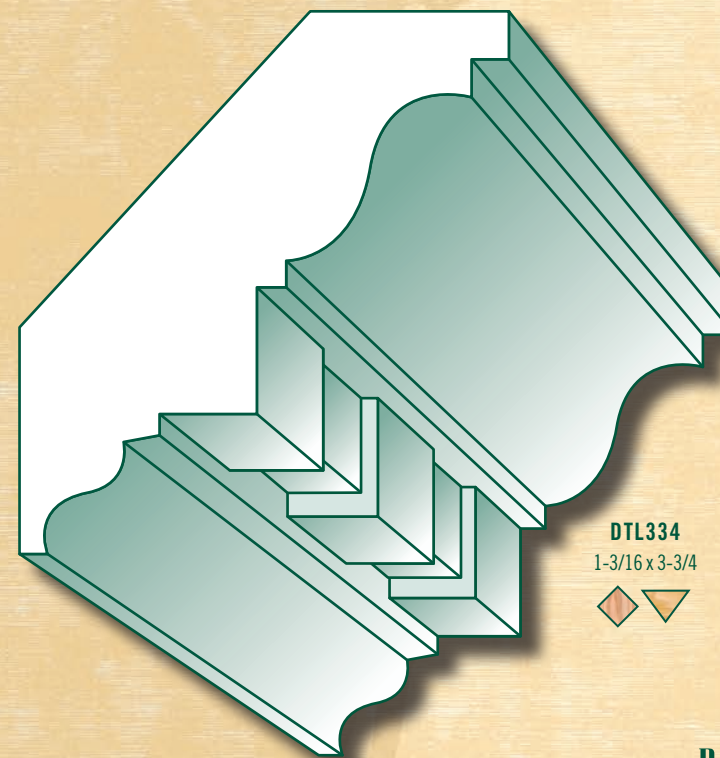

DENTIL MOULDINGS

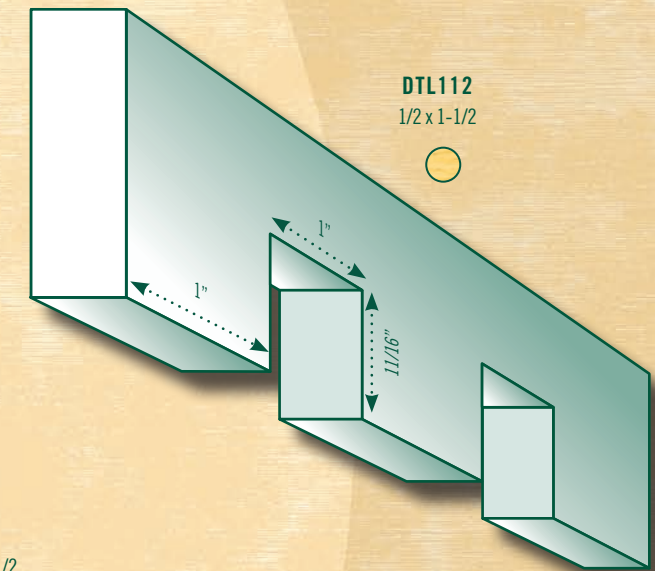

ROPE



POPLAR
RP12
1/2
RP34
3/4

All profiles are available in select hardwood species on a special order basis (see pages 127-133 for our hardwood moulding programs)

● PINE
 ● PRIMED
 ◆ OAK
 ◆ ULTRALITE MDF
 ▽ PRIMED POPLAR
 ▽ POPLAR
 ● PVC



CHAIR RAIL - PRESTIGE LINE, ESTATE SERIES, & DESIGNER COLLECTION

CHAIR RAILS - CAMELBACK

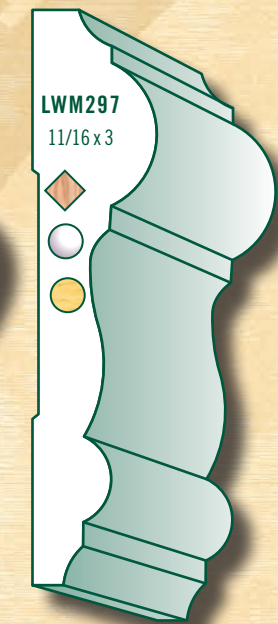
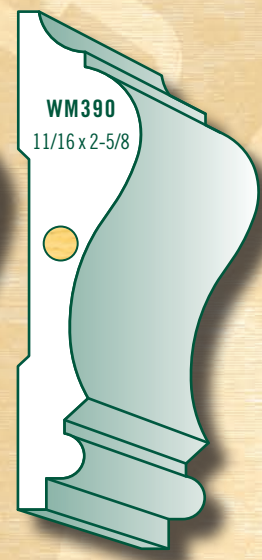
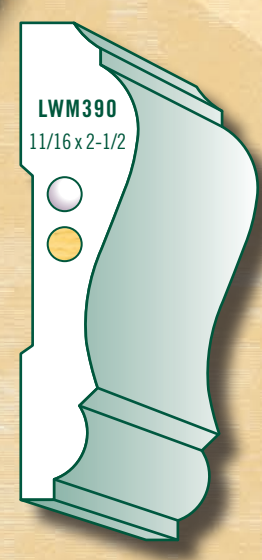

LWM297
11/16 x 3

CHAIR RAILS - BEADED

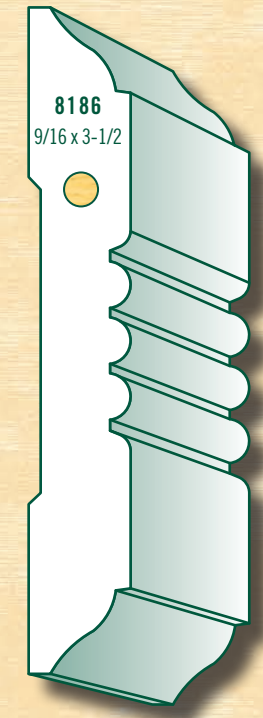

8186
9/16 x 3-1/2

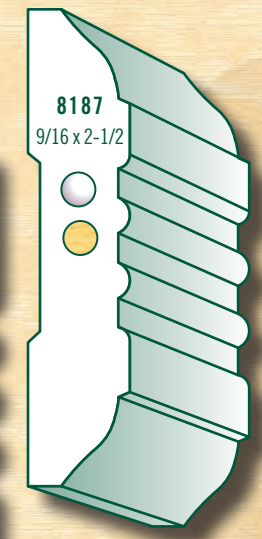

8187
9/16 x 2-1/2



8121 Bull Nose w/SC214 Solid Crown, SB158VB Beadboard, GSB725 Base, SH1 Shoe, GS425 Casing

All profiles are available in select hardwood species on a special order basis (see pages 127-133 for our hardwood moulding programs)

- PINE
- PRIMED
- ◆ OAK
- ULTRALITE MDF
- ▽ PRIMED POPLAR
- ▽ POPLAR
- PVC

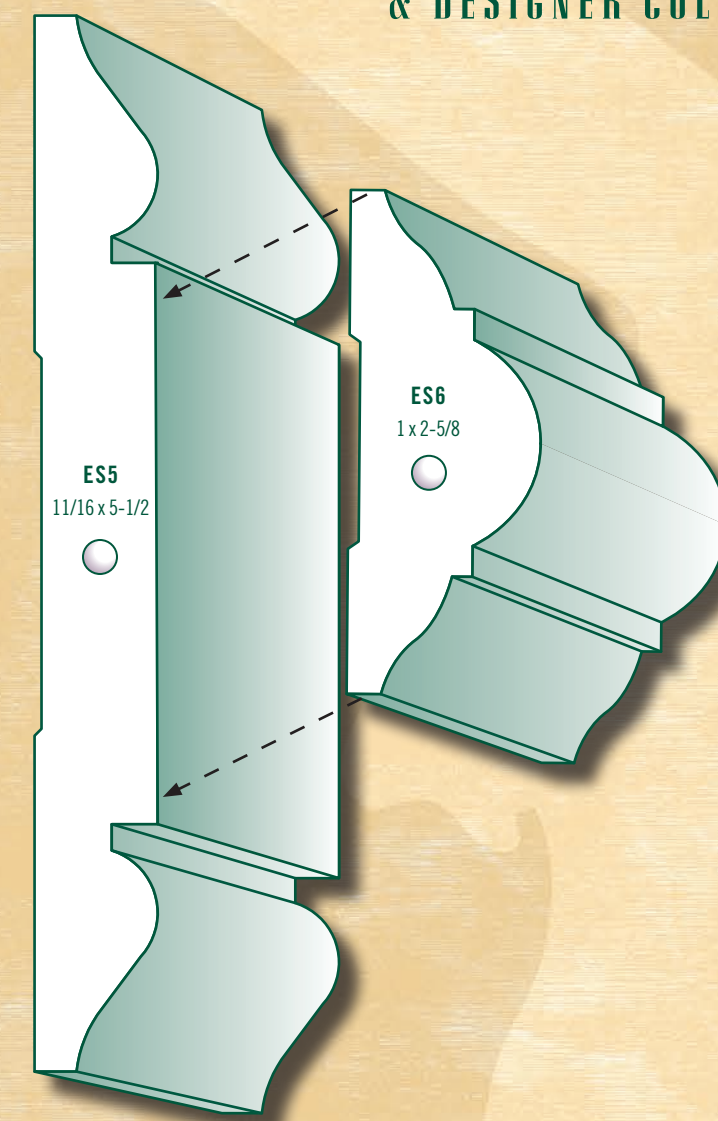

ES5
11/16 x 5-1/2

ES6
1 x 2-5/8



DCAS5
1-3/4 x 5-1/2
18' Lengths
* Also used as Casing



DCAS5 used as a Chair Rail



ES5 & ES6



ES8
1-1/8 x 3-1/2

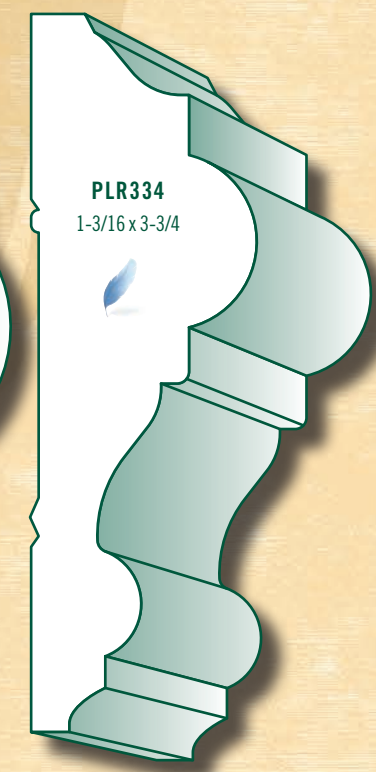

PLR334
1-3/16 x 3-3/4

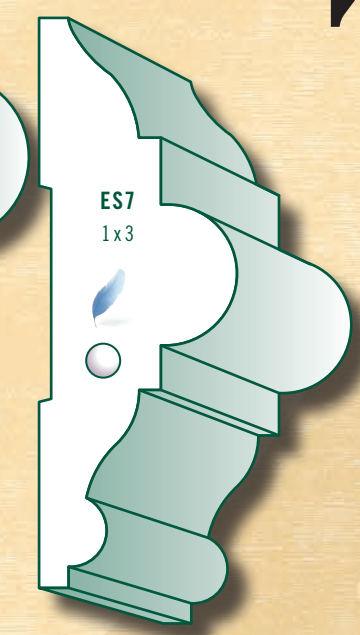

ES7
1 x 3



PLR334

The **DESIGNER** COLLECTION

BASE CAP/PANEL



ECB Cap, BC78 Panel, BC78 Base Cap, 1" x 4"-6"-12", and JC412 Casing

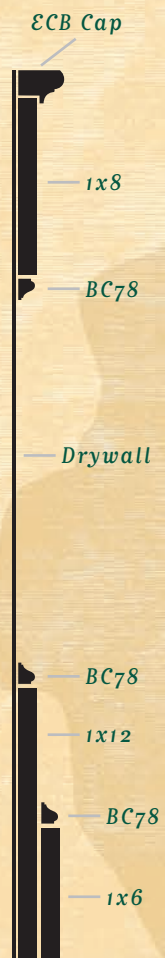

ES8 Chair Rail, PL2 Panel & BB6 Base – Radius corners of the 8416 (8416RCMDF), PL134 (PL134RCMDF) and PL 2 (PL2RCMDF) shown here are available in packs of 4 in MDF.

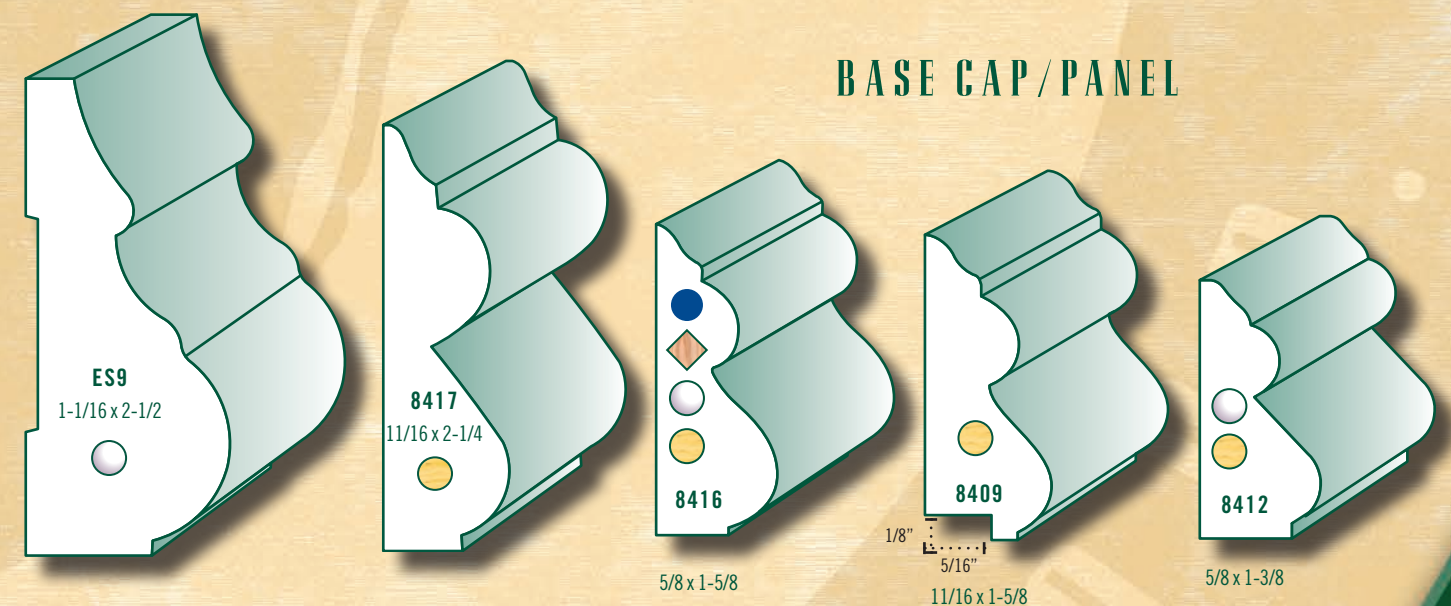
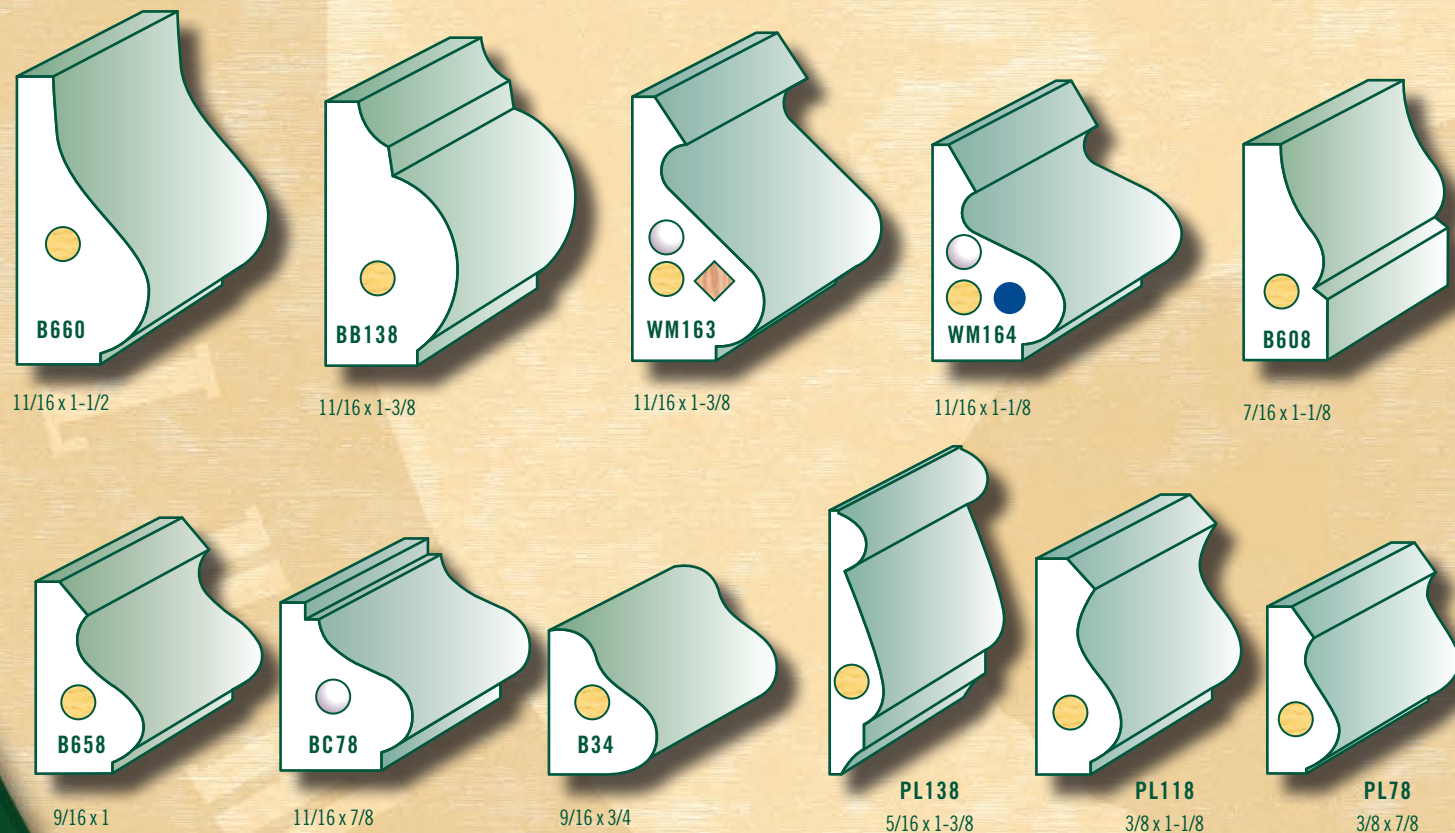

BASE CAP/PANEL

All profiles are available in select hardwood species on a special order basis (see pages 127-133 for our hardwood moulding programs)

● PINE
 ● PRIMED
 ◆ OAK
 ● ULTRALITE MDF
 ▽ PRIMED POPLAR
 ▽ POPLAR
 ● PVC



PANEL MOULDINGS

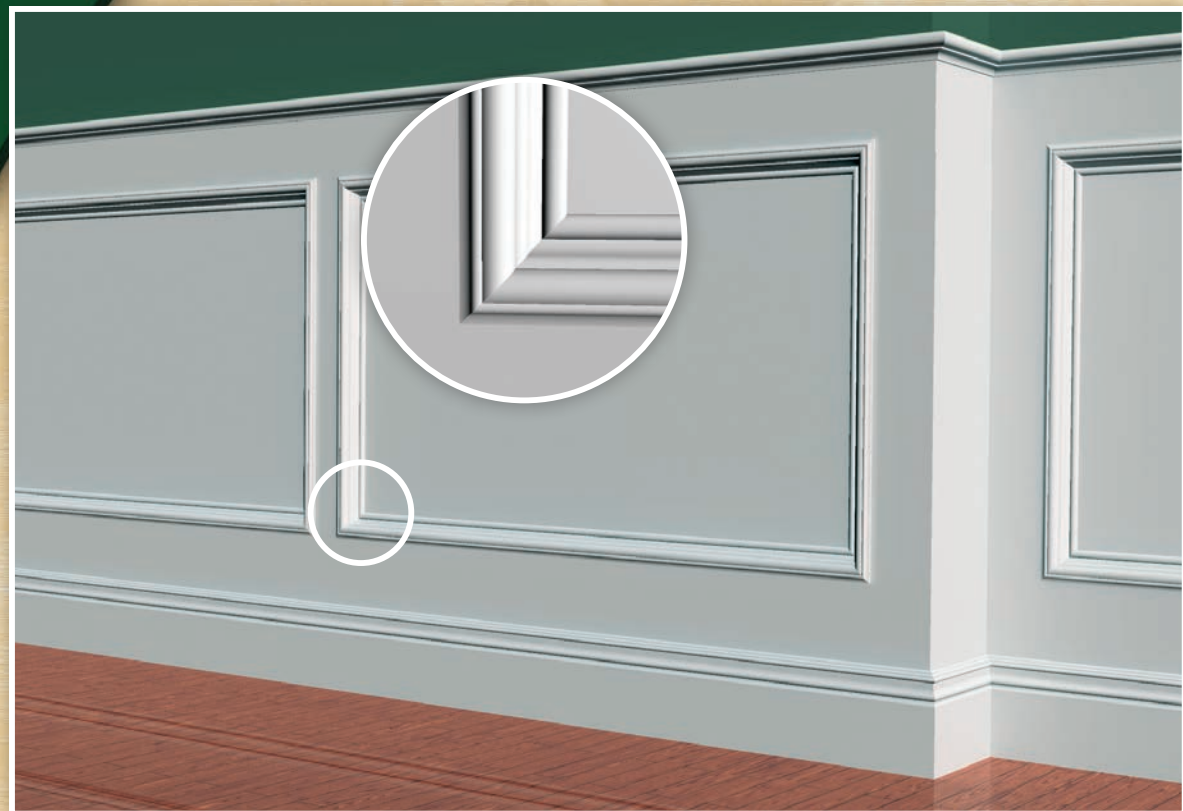

1" x 4", 1" x 6", 1" x 12", BB6 Base, ECBCAP & ES11 Panel Moulding

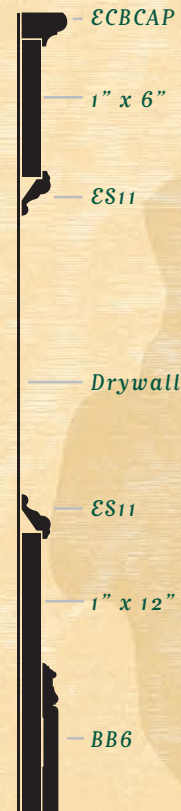

NOSE & COVES

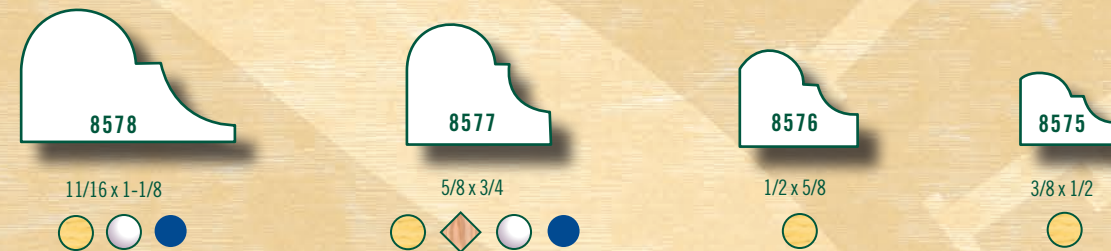

PANEL MOULDINGS

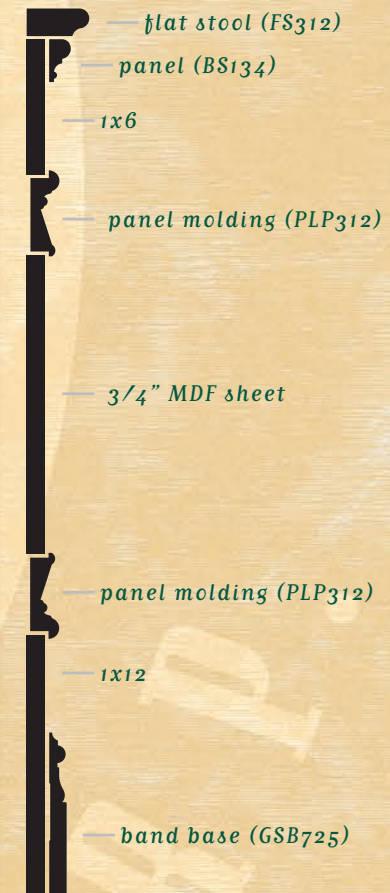
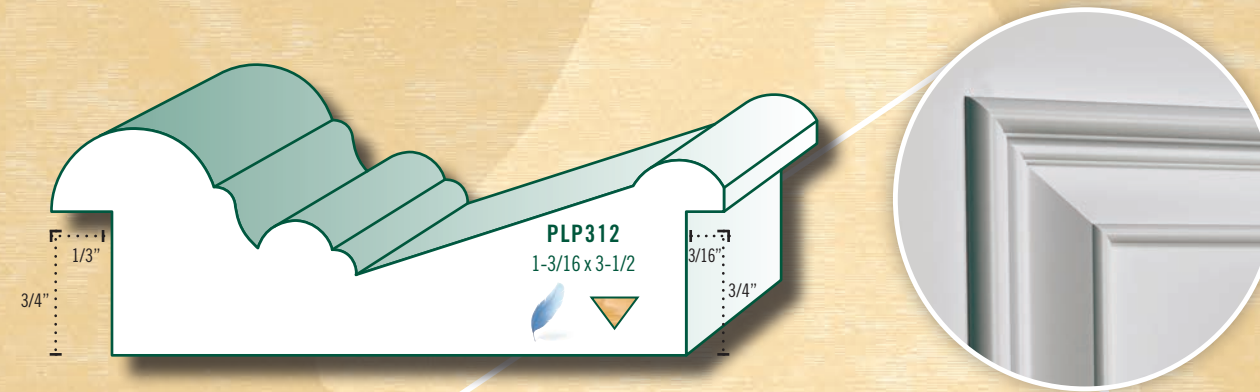

PLP312 Panel, BB7 Base, 1" x 12", 1" x 6" and 1" x 5" Precision Poplar S4S, 3/4" Ultra Lite MDF Panel

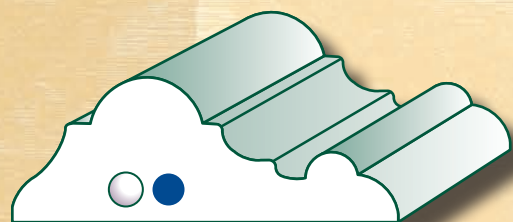

PL2 3/4x2

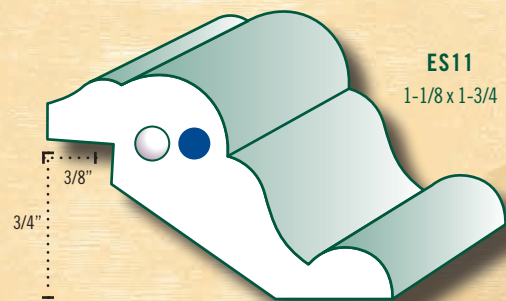

ES11
1-1/8x1-3/4

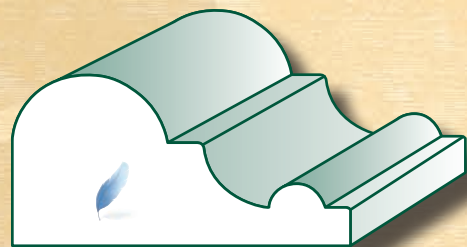

BS134 7/8x1-3/4

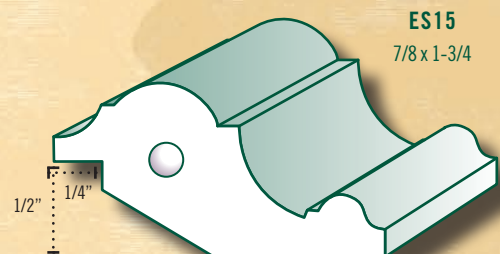

ES15
7/8x1-3/4

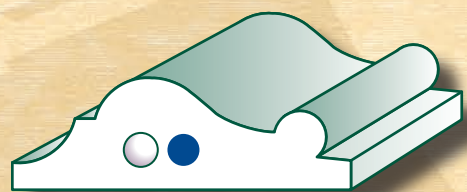

PL134 5/8x1-3/4

All profiles are available in select hardwood species on a special order basis (see pages 127-133 for our hardwood moulding programs)

PINE
 PRIMED
 OAK
 ULTRALITE MDF
 PRIMED POPLAR
 POPLAR
 PVC





BASE CAP/PANEL

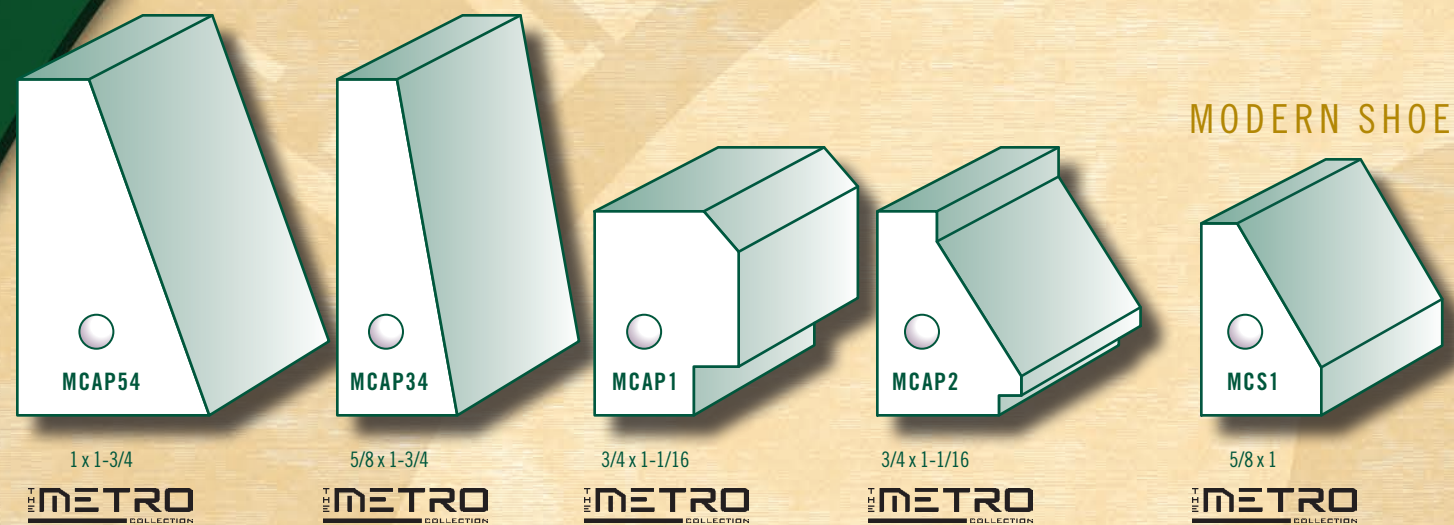

MODERN SHOE

BASE CAP/PANEL USED IN BASE APPLICATIONS



MCS1 Shoe used as cap, 1" x 6", MCS1 Shoe Moulding



MCAP2 Cap, 1" x 6", MCS1 Shoe Moulding



MCAP1 Cap, 1" x 8", MCS1 Shoe Moulding



MCAP34 Cap, 1" x 6", MCS1 Shoe Moulding

All profiles are available in select bardwood species on a special order basis (see pages 127-133 for our bardwood moulding programs)

PINE
 PRIMED
 OAK
 ULTRALITE MDF
 PRIMED POPLAR
 POPLAR
 PVC

METRO COLLECTION PANEL APPLICATION



MCAP54, MCS1, 1" x 6", 1" x 12"



MCAP34, 1" x 6", 1" x 12"

METRO COLLECTION PANEL APPLICATION

- 1" x 3" MSC175
- 1" x 6" MCAP2
- 1" x 4" MCAP2
- Drywall
- 1" x 10" MCAP2
- 1" x 5" MCS1



MSC175, MCAP2, MCS1, 1" x 3", 1" x 4", 1" x 5", 1" x 6", 1" x 10"

- 8121 MSC225
- 1" x 6" MCAP1
- Drywall
- 1" x 12" MCB712
- MCS1



8121, MSC225, MCAP1, MCB712, MCS1, 1" x 6", 1" x 12"

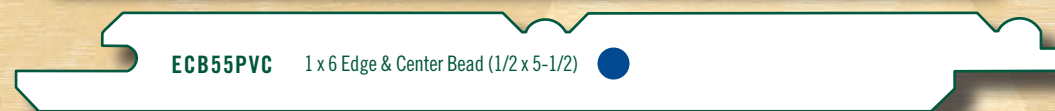

WAINSCOTING & EDGE & CENTER BEADS

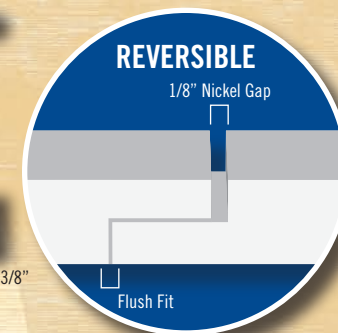

PLATINUM PROTECTED 30 YEAR WARRANTY

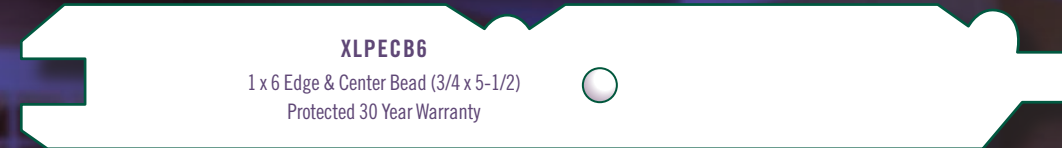
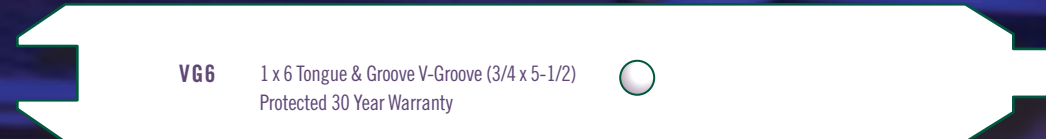
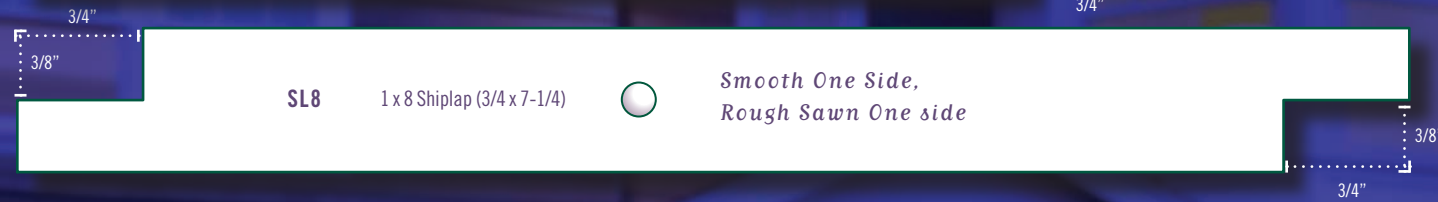
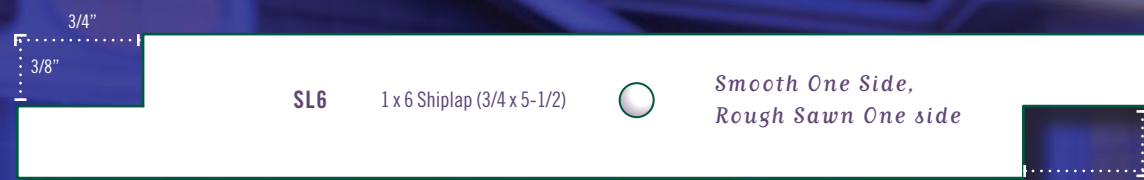

EDGE & CENTER BEAD CAP

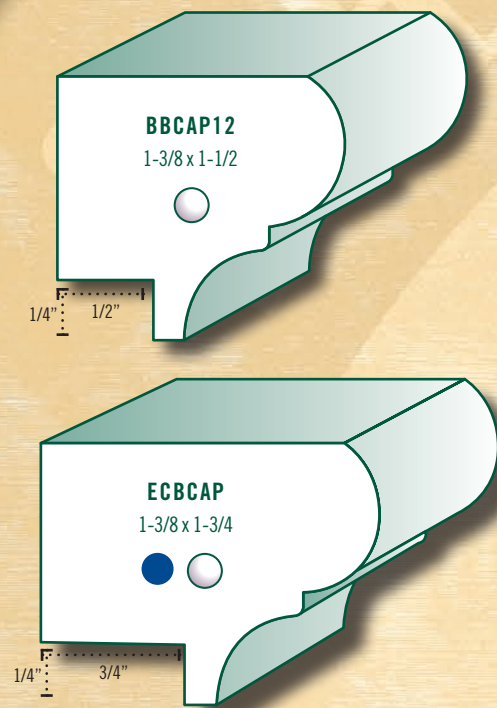

WAINSCOAT CAPS

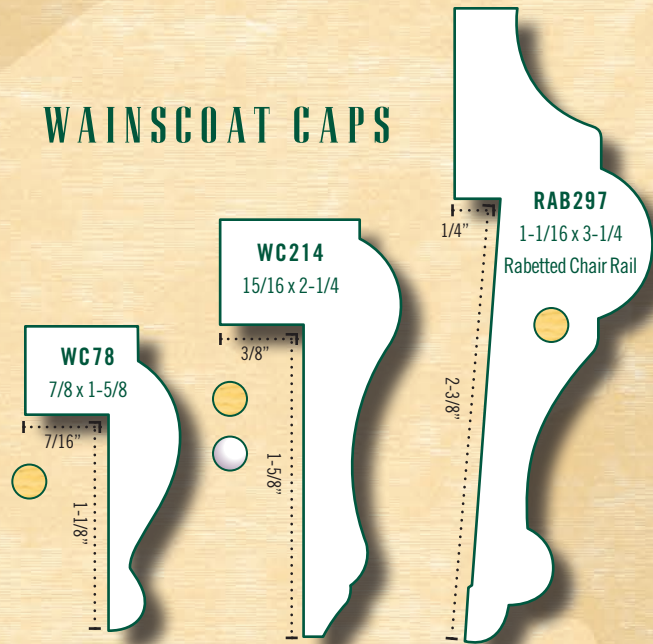

ASTRAGALS & MULLION CENTERS

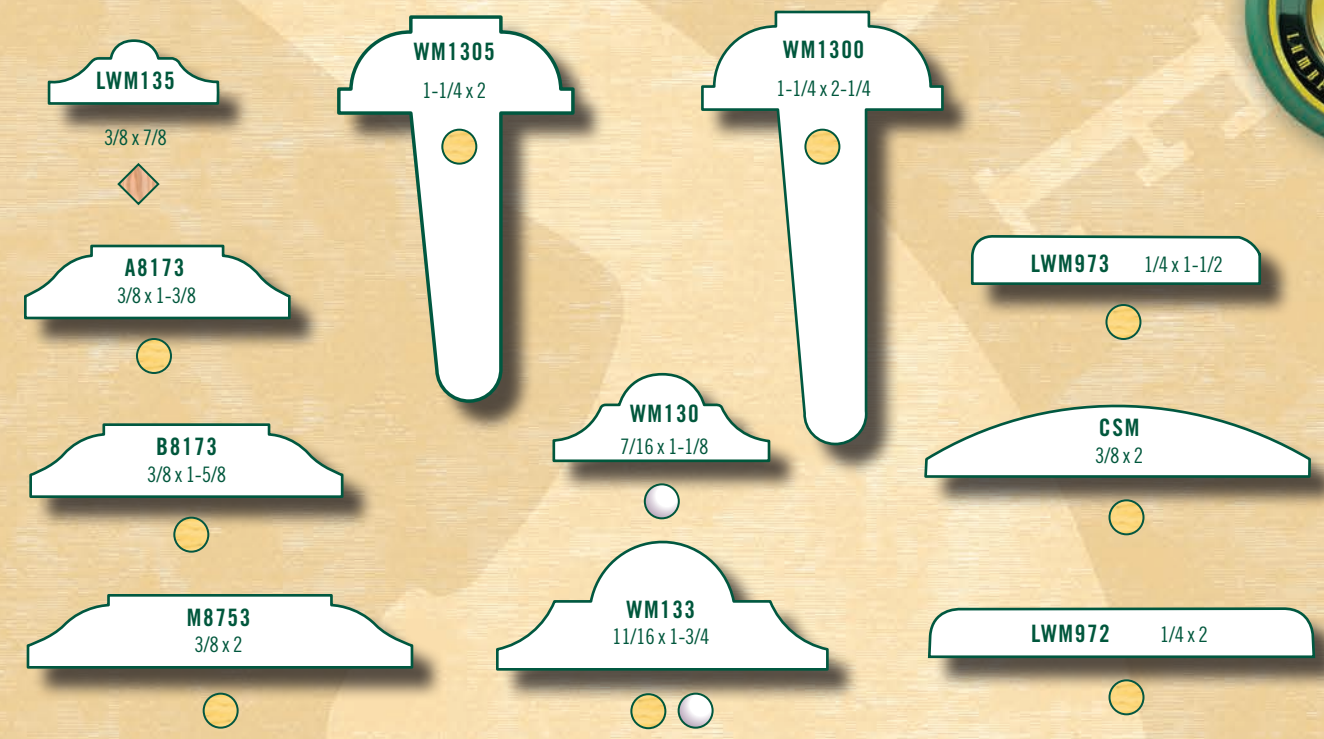

BBCAP12, 4" On Center Modern Groove Sheets, 8" Modern Shiplap Strips, BC5 Crown, SAN525 Base

All profiles are available in select hardwood species on a special order basis (see pages 127-133 for our hardwood moulding programs)

● PINE ● PRIMED ◆ OAK ● ULTRALITE MDF ▼ PRIMED POPLAR ▼ POPLAR ● PVC

BALUSTERS

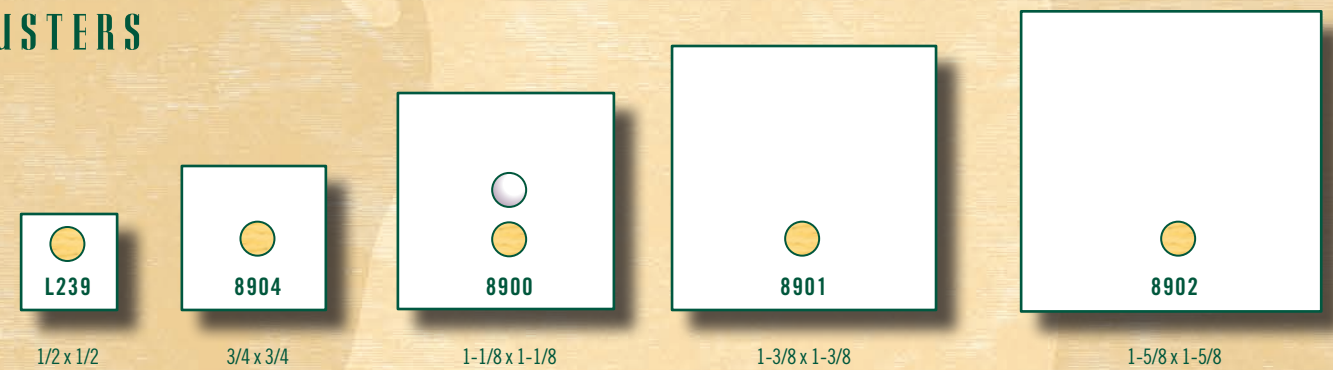

BAND / RAKE MOULDINGS

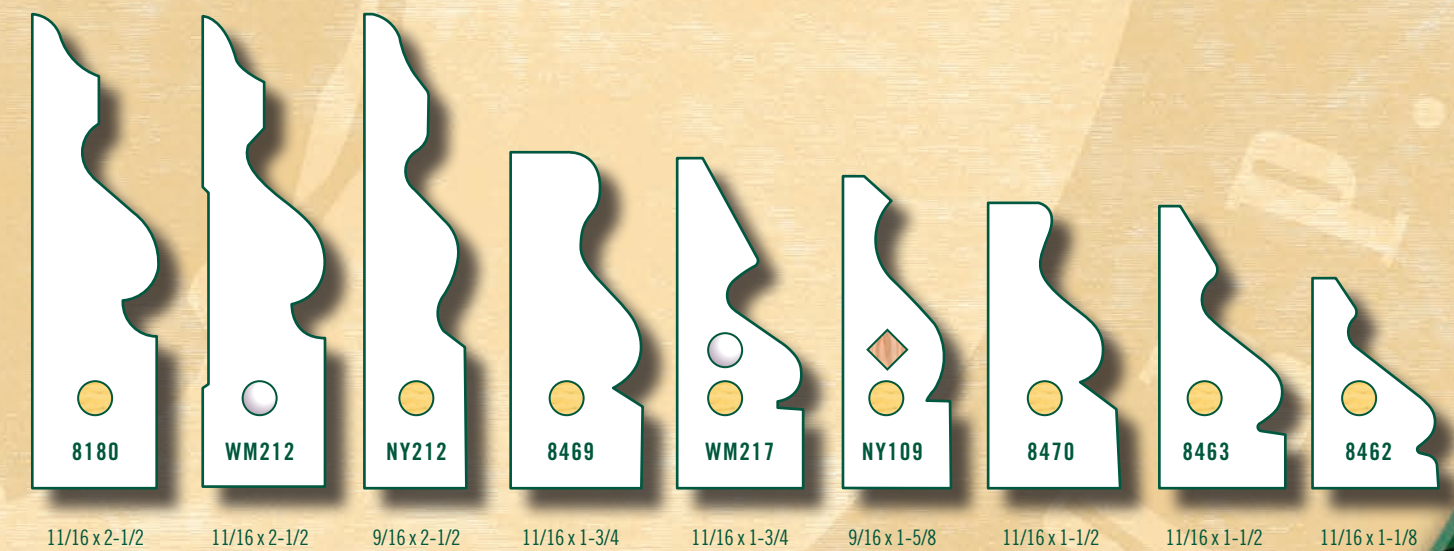



PICTURE FRAME

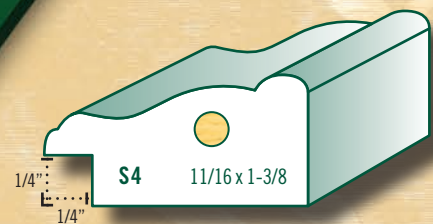

PICTURE MOULDINGS

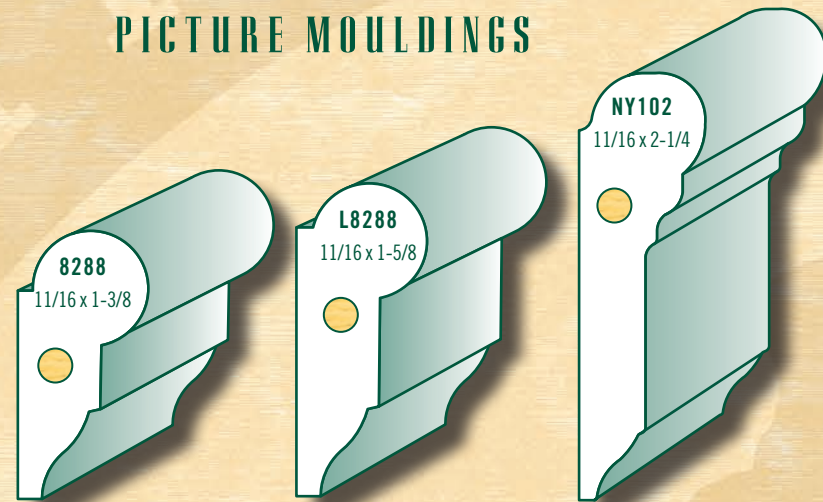

SANITARY EDGE



1/4 x 3/4

SCREEN Moulding



1/4 x 5/8

BEADED EDGE



1/4 x 3/4

SKREW BACKS (CHAMFERS)



3/4 x 3/4



1 x 1

GLASS BEADS



3/8 x 1/2



7/16 x 3/4



3/8 x 7/8

Flat glass Bead

LATTICES

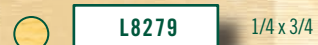

1/4 x 3/4

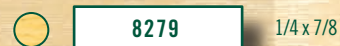

1/4 x 7/8



1/4 x 1-1/8



1/4 x 1-3/8

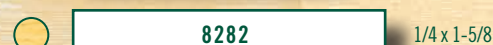

1/4 x 1-5/8



1/4 x 1-3/4

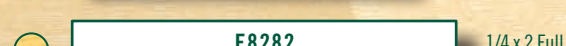

1/4 x 2 Full



1/4 x 2-1/4



1/4 x 2-5/8



1/4 x 3-1/2



1/4 x 5-1/4



D4 1/2 x 6 (1/2 x 5-1/2 actual size)

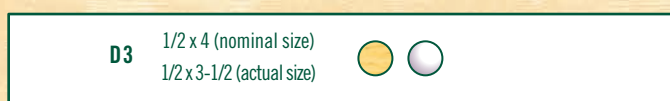

D3 1/2 x 4 (nominal size)
1/2 x 3-1/2 (actual size)

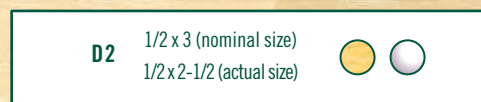

D2 1/2 x 3 (nominal size)
1/2 x 2-1/2 (actual size)

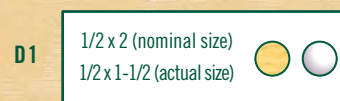

D1 1/2 x 2 (nominal size)
1/2 x 1-1/2 (actual size)

PARTING STRIP



1/2 x 3/4

STOPS - CLAM SHELL



WP845
1/2 x 1-5/8



WP855
3/8 x 1-5/8



WP856
3/8 x 1-3/8



WP858
3/8 x 1-1/8



WP830
3/8 x 7/8



WP831
3/8 x 3/4

STOPS - COLONIAL



G8090
3/8 x 2-1/4



WM935
7/16 x 1-5/8



E8090
3/8 x 1-5/8



WM936
7/16 x 1-3/8



D8090
3/8 x 1-3/8



WM938
7/16 x 1-1/8



C8090
3/8 x 1-1/8



B8090
3/8 x 7/8



A8090
3/8 x 3/4



WP925
1/2 x 1-5/8

STOP - EXTERIOR

STOP - GARAGE DOOR



LWM903 9/16 x 2-1/4

BULLNOSE



8144 11/16 x 1-3/4

STOPS - SANITARY



WM875
7/16 x 1-5/8



WM876
7/16 x 1-3/8



WM887
3/8 x 1-1/4



WM888
3/8 x 1-1/8



8121
9/16 x 2-1/4



B8121
5/8 x 1-5/8



D8121
7/16 x 1-5/8



A8121
5/8 x 1-3/8



C8121
7/16 x 1-3/8



L953
5/8 x 7/8
Sash Bead

All profiles are available in select hardwood species on a special order basis (see pages 127-133 for our hardwood moulding programs)

PINE
 PRIMED
 OAK
 ULTRALITE MDF
 PRIMED POPLAR
 POPLAR
 PVC



SANITARY CORNER GUARDS

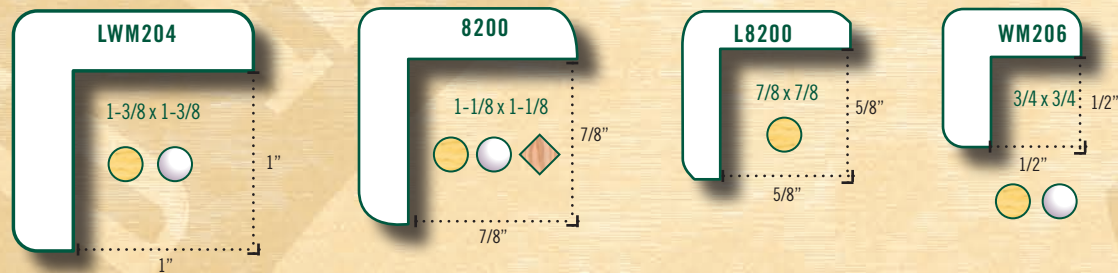

COLONIAL CORNER GUARDS

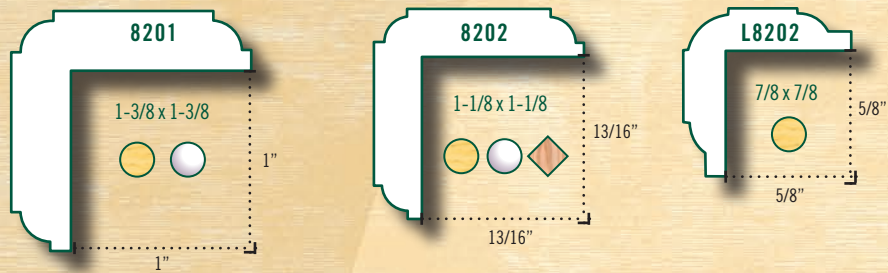

SANITARY CAPS

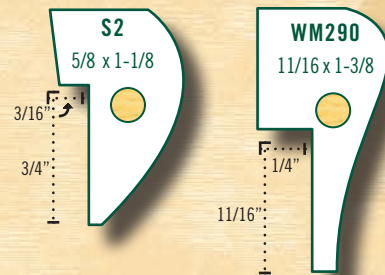

DRIP CAPS

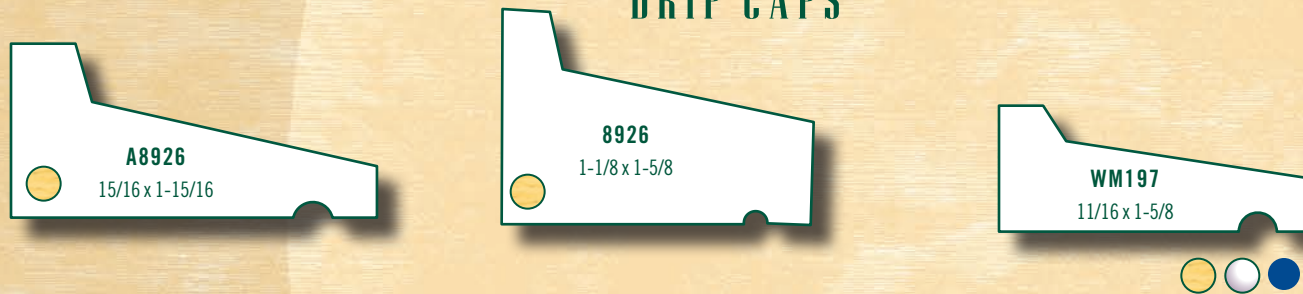

YELLOW PINE T&G FLOORING



STEPPING

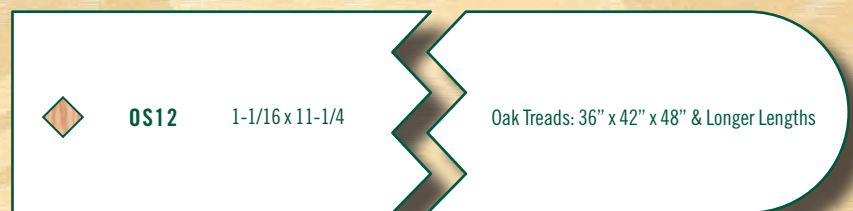

POLES

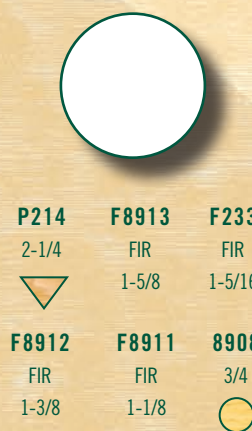

HALF ROUNDS

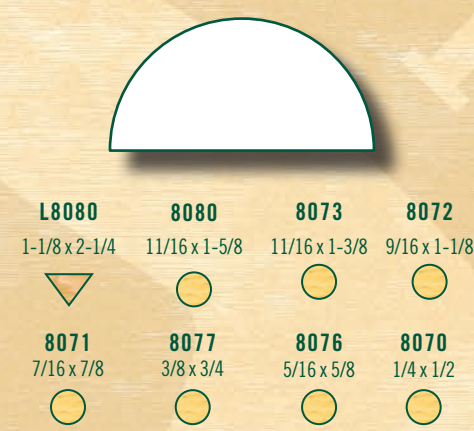

QUARTER ROUNDS

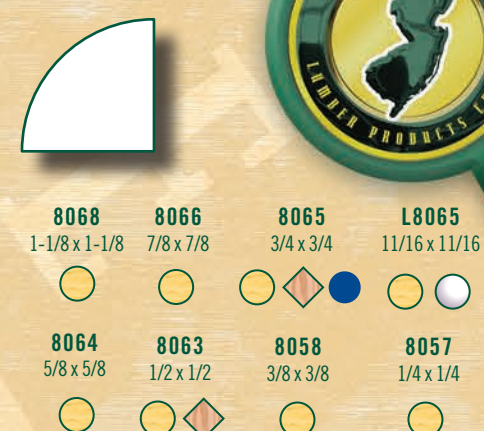

OVAL HAND RAIL

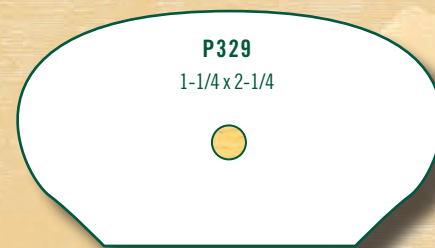

HAND RAIL



HAND RAIL KEYHOLE

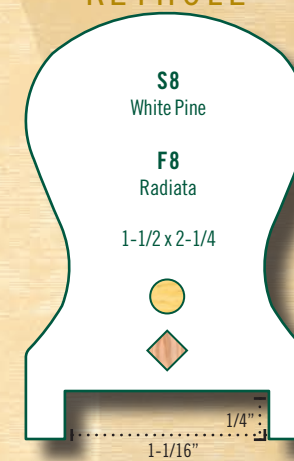

PORCH RAIL - TOP



PORCH RAIL - BOTTOM



FLAT BOTTOM RAIL

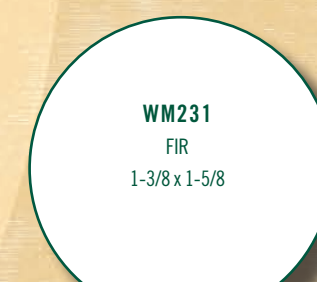

CHICAGO BAR RAIL



All profiles are available in select hardwood species on a special order basis (see pages 127-133 for our hardwood moulding programs)

● PINE
 ● PRIMED
 ◆ OAK
 ■ ULTRALITE MDF
 ▽ PRIMED POPLAR
 ▽ POPLAR
 ● PVC



EXTENSION JAMBS

CASEMENT

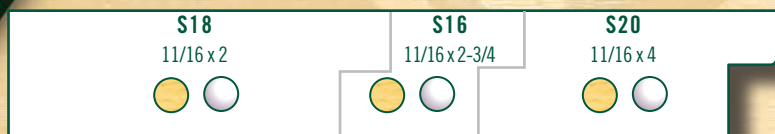

See PVC section for
PVC Sills and other
PVC profiles

NARROWLINE



TILT WASH

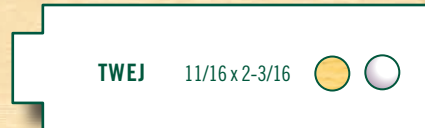

STOOL - FLAT

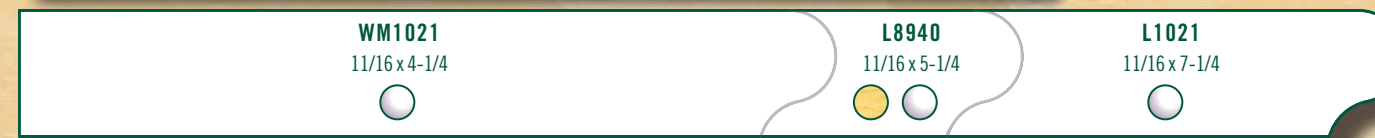

STOOL - NARROWLINE



BULLNOSE

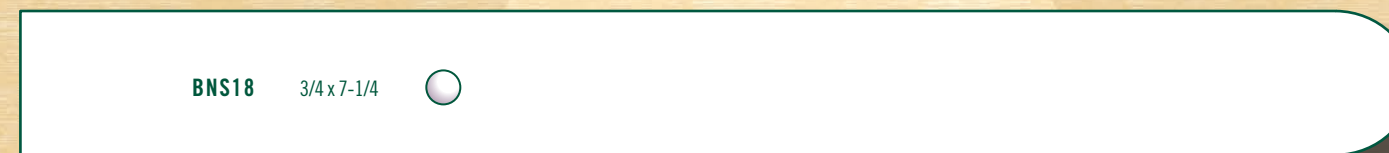

STOOL - TILT WASH



STOOL - CASEMENT

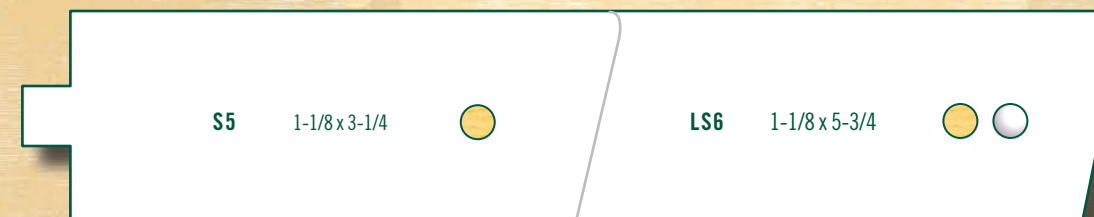

STOOL - 200 SERIES



DOOR SILLS

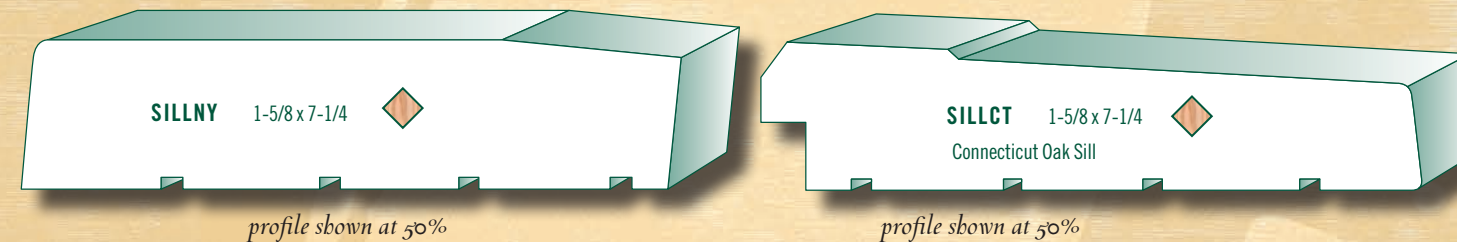

STOOL - RABETTED



WINDOW SILLS

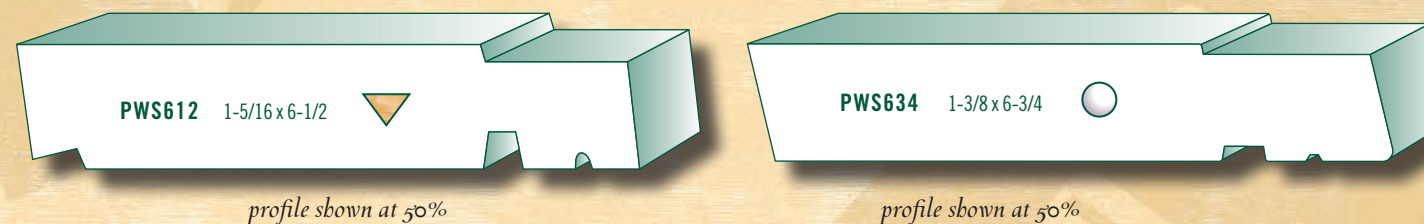

All profiles are available in select hardwood species on a special order basis (see pages 127-133 for our hardwood moulding programs)

● PINE
 ● PRIMED
 ◆ OAK
 ▲ ULTRALITE MDF
 ▽ PRIMED POPLAR
 ▽ POPLAR
 ● PVC

MANTEL

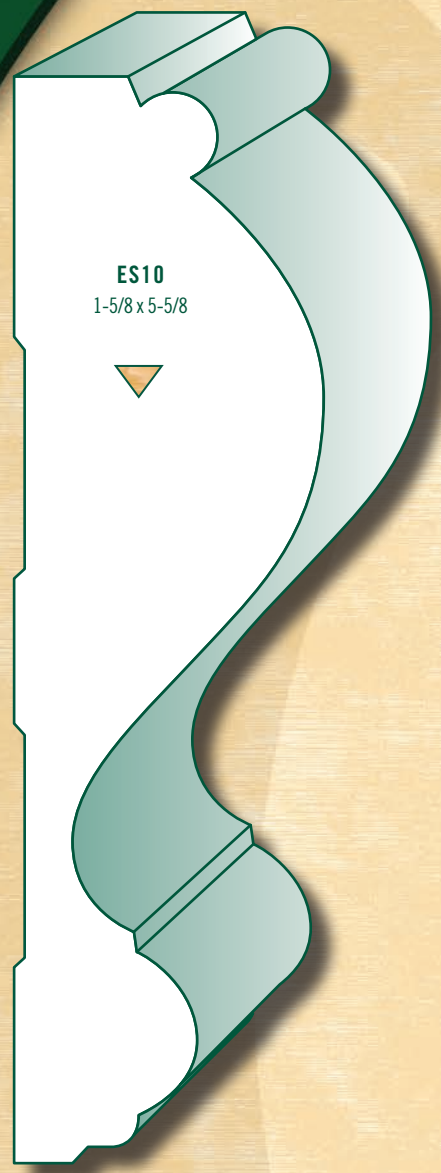

ES10
1-5/8 x 5-5/8

OAK HEARTH BORDER

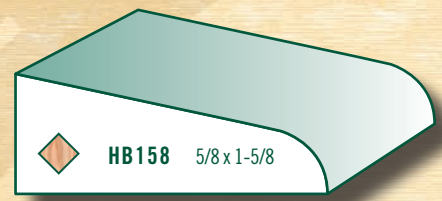

HB158 5/8 x 1-5/8

CEDAR CLOSET LINING



CCL32 1/4 x 3-7/8 32 Sq Ft Per Box

LANDING TREADS



LT312 1-1/16 x 3-1/2

OAK SADDLES

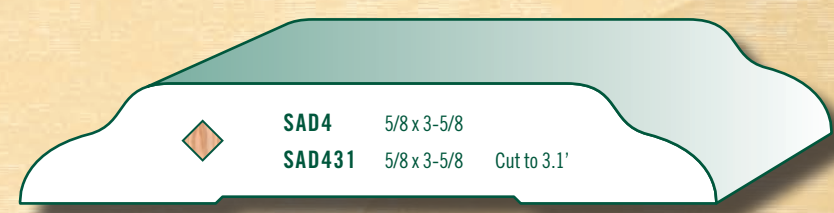

SAD4 5/8 x 3-5/8
SAD431 5/8 x 3-5/8 Cut to 3.1'

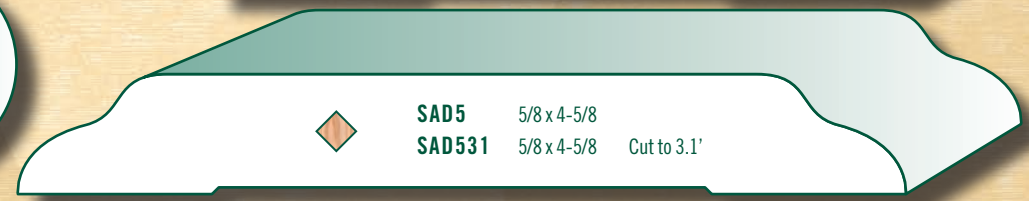

SAD5 5/8 x 4-5/8
SAD531 5/8 x 4-5/8 Cut to 3.1'

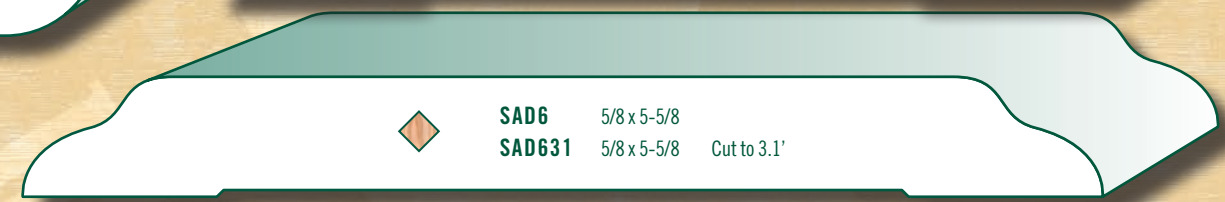

SAD6 5/8 x 5-5/8
SAD631 5/8 x 5-5/8 Cut to 3.1'

OAK NOSING

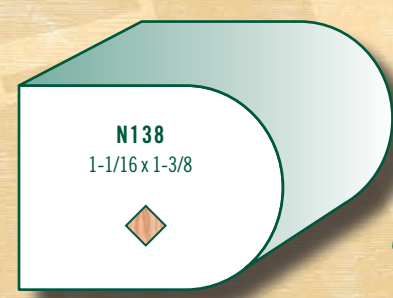

N138
1-1/16 x 1-3/8



Coffered Ceiling: MCR714, S4S with MCS1 Shoe

Fire Place Panel Insert: MCAP2 with MSC275, Mantel Trim Piece: MSC175 Crown

Base: MCB712 with MCS1 Shoe, Casing: MCC312 with MCBB2, Apron: MCC212

All profiles are available in select hardwood species on a special order basis (see pages 127-133 for our hardwood moulding programs)

- PINE
- PRIMED
- OAK
- ULTRALITE MDF
- PRIMED POPLAR
- POPLAR
- PVC

CASINGS



MCC534
1-3/8" x 5-3/4"



MCC434
1-3/8" x 4-3/4"



MCC334
1-1/8" x 3-3/4"



MCC334 Casing

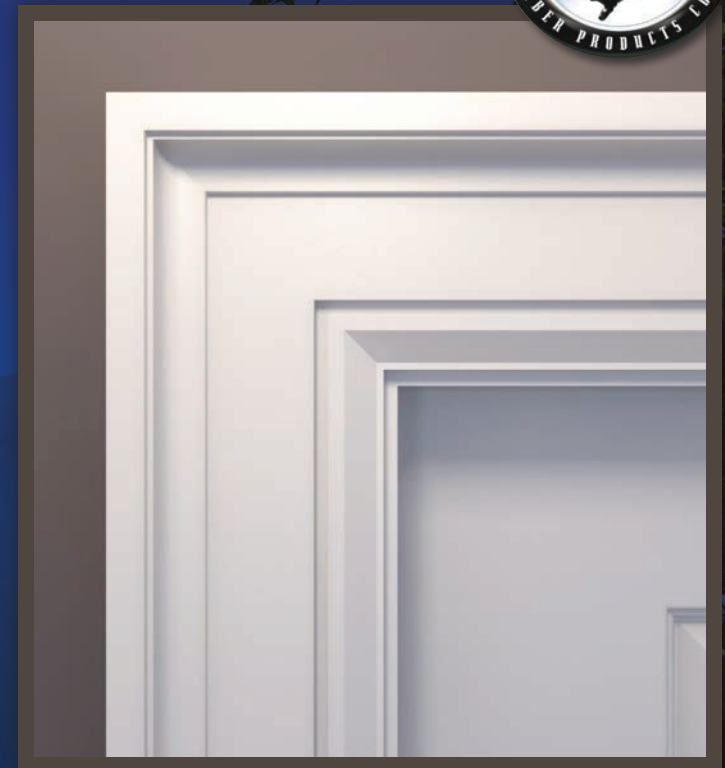

MCC434 Casing



MCC534 Casing



MCC434 Used as Chair Rail

CASINGS



MCC575
1-3/8" x 5-3/4"



MCC475
1-3/8" x 4-3/4"



MCC375
1-1/8" x 3-3/4"



MCC375 Casing

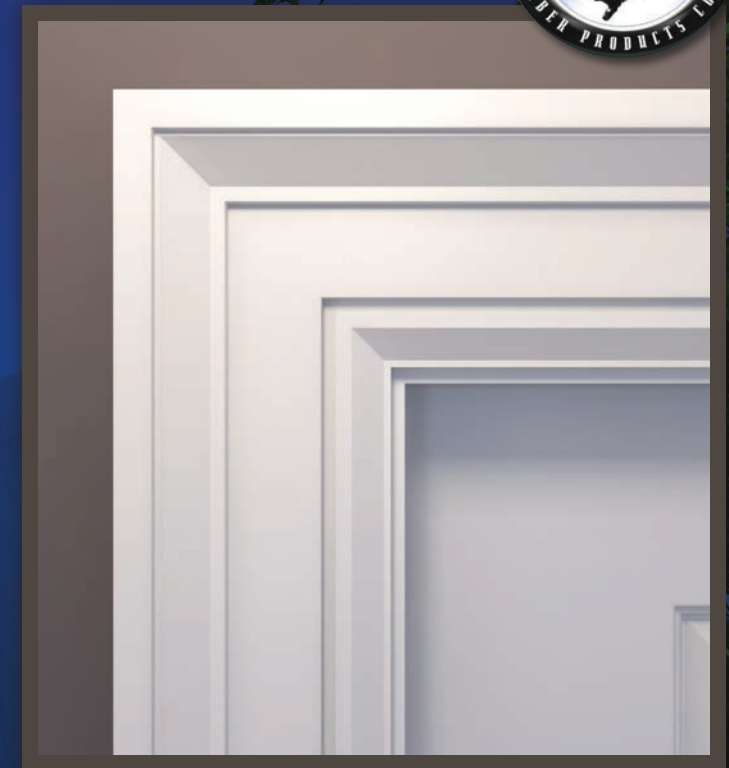

MCC475 Casing



MCC575 Casing



MCC475 Used as Chair Rail

CASINGS

BACK BANDS

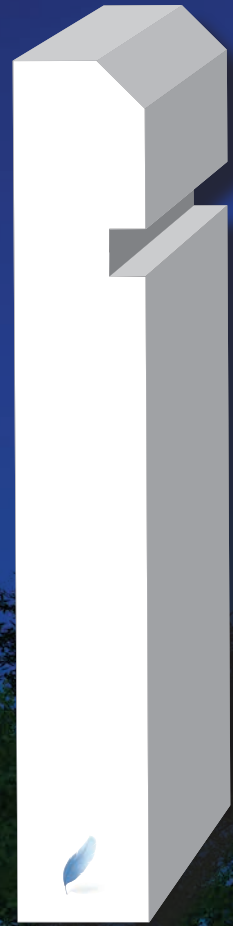

MCC412
11/16" x 4-1/2"

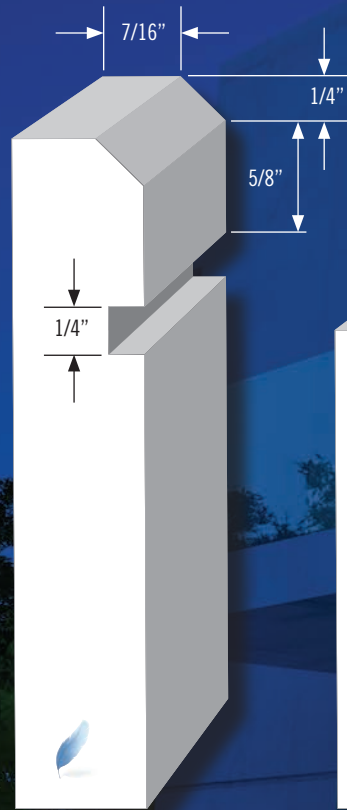

MCC312
11/16" x 3-1/2"



MCC212
11/16" x 2-1/2"

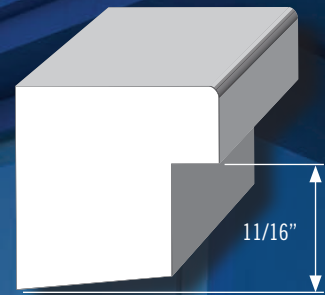

MCBB1
1-1/16" x 1-1/16"



MCBB2
1-1/16" x 1-1/16"

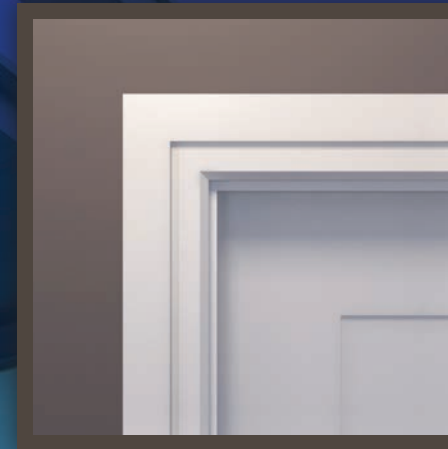

MCC212 Casing



MCC212 Casing & MCBB1 Back Band

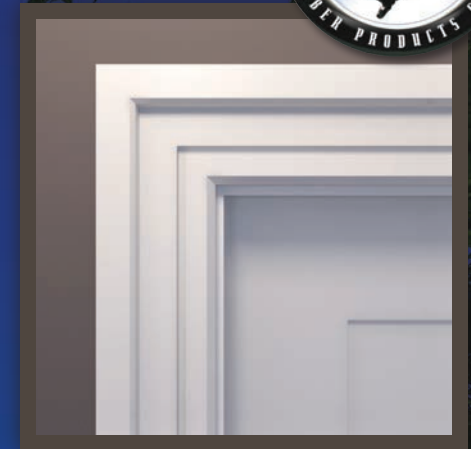

MCC212 Casing & MCBB2 Back Band

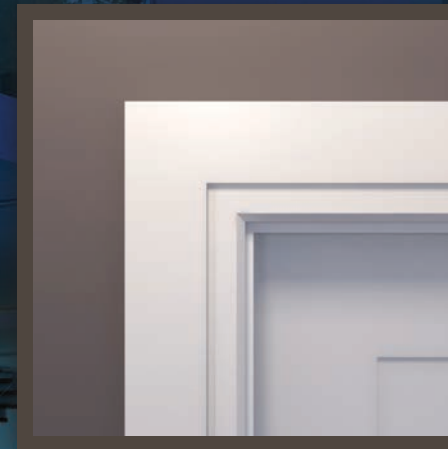

MCC312 Casing



MCC312 Casing & MCBB1 Back Band

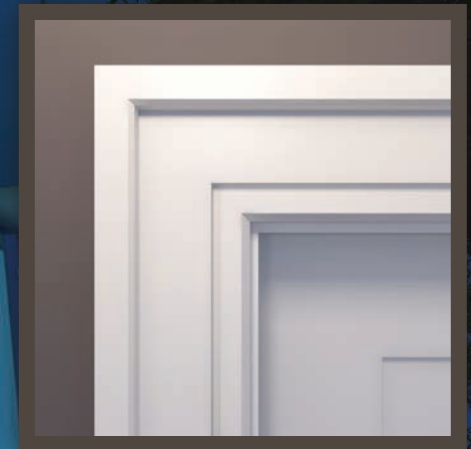

MCC312 Casing & MCBB2 Back Band

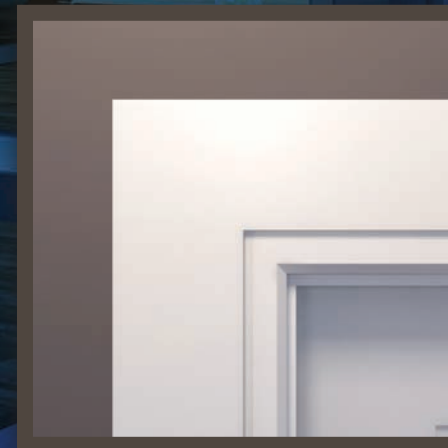

MCC412 Casing

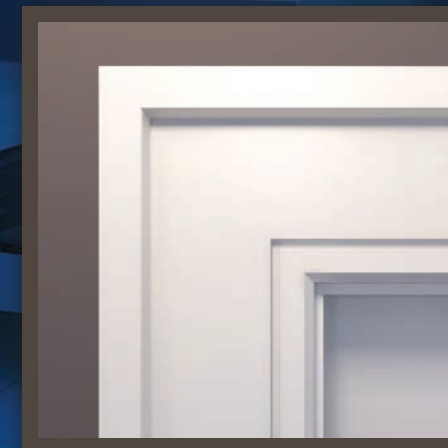

MCC412 Casing & MCBB1 Back Band

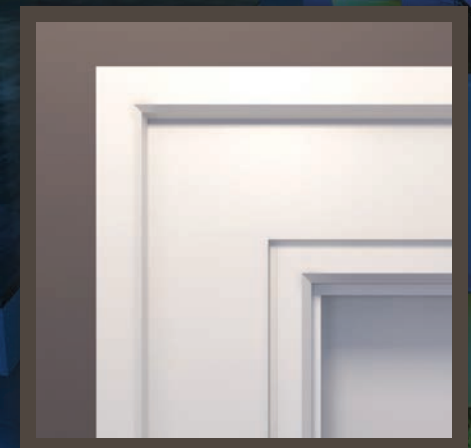

MCC412 Casing & MCBB2 Back Band



MCC312 Casing, MCBB1 Back Band, LS6 Sill, MCC212 Apron

CHAIR RAILS



MCC475

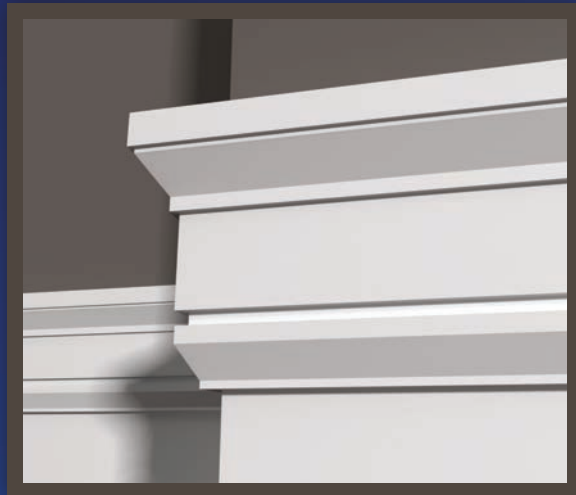

MCC475 Used as Chair Rail

MCC334



MCC334 Used as Chair Rail

MCAP1

1" x 3"



MCAP1



MCAP1 with 1" x 3"

MCAP2

1" x 4"



MCAP2



MCAP2 with 1" x 4"

MSC175

5/4" x 4"



MSC175



MSC175 with 5/4" x 4"

1/2" x 3"



MSC275

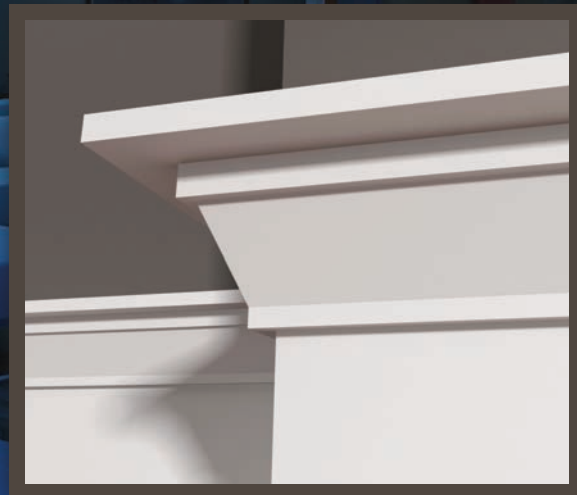

MSC275 with 1/2" x 3"

BASES



MCB725
9/16" x 7-1/4"

MCB525
9/16" x 5-1/4"



MCB525 Base



MCB725 Base

MODERN
SHOE

BASES



MCS1
5/8" x 1"

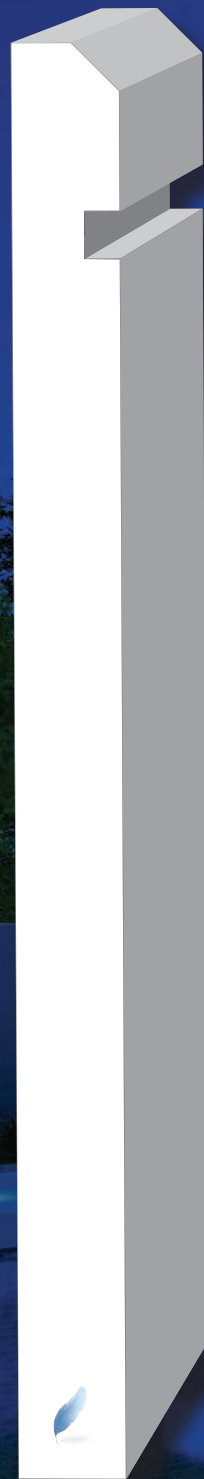

MCB712
9/16" x 7-1/2"

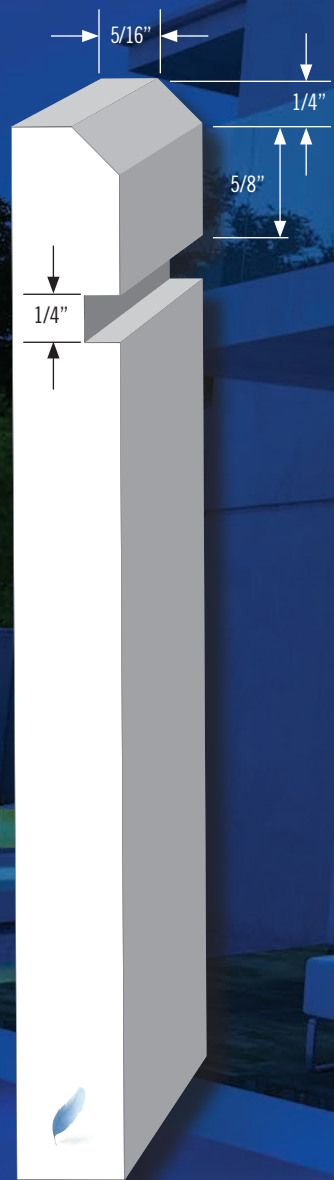

MCB512
9/16" x 5-1/2"



MCB7
11/16" x 7"

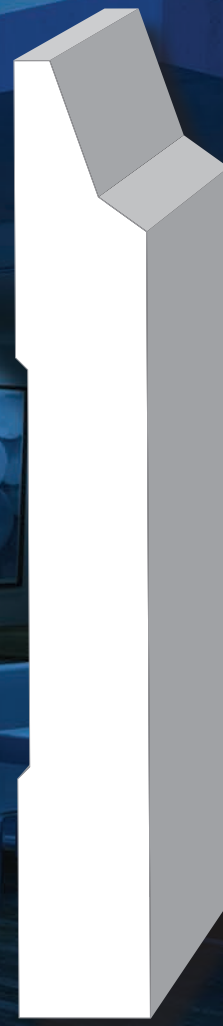

MCB5
11/16" x 5"



MCB512 Base, MCS1 Shoe

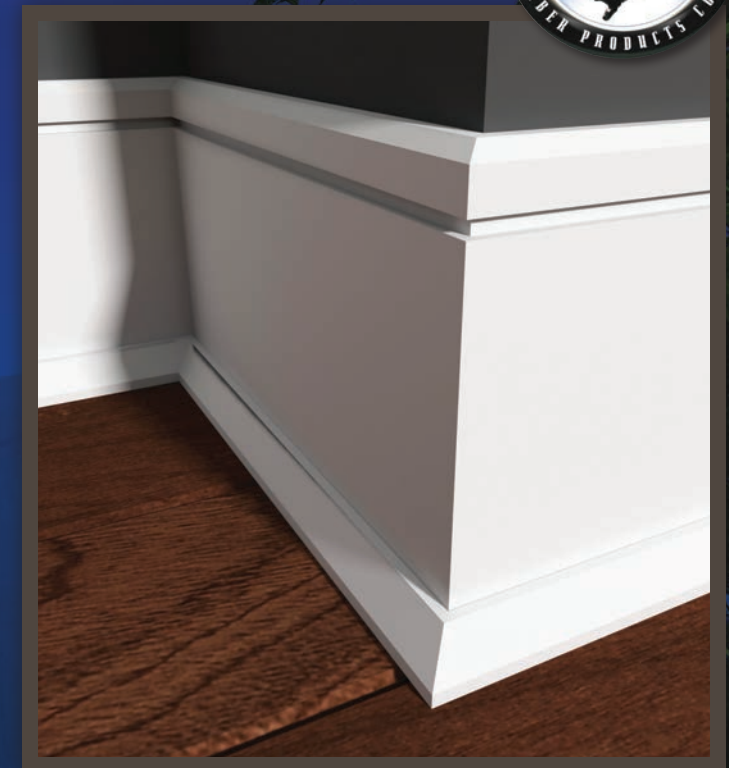

MCB712 Base, MCS1 Shoe



MCB5 Base



MCB7 Base, MCS1 Shoe

CAPS & S4S

USED IN BASE APPLICATIONS

Add our Metro Caps & Panels to our S4S for an endless array of design details



PLATINUM XL = **XL**



30 YEAR WARRANTY

PLATINUM PROTECTED = **XLP**

1/2 x S4S:

- 1/2 x 2 (1/2 x 1-1/2) **XL**
- 1/2 x 3 (1/2 x 2-1/2) **XL**
- 1/2 x 4 (1/2 x 3-1/2) **XL**
- 1/2 x 6 (1/2 x 5-1/2) **XL**

1 x S4S:

- 1 x 2 (3/4 x 1-1/2) **XL**
- 1 x 3 (3/4 x 2-1/2) **XL XLP**
- 1 x 4 (3/4 x 3-1/2) **XL XLP**
- 1 x 5 (3/4 x 4-1/2) **XL XLP**
- 1 x 6 (3/4 x 5-1/2) **XL XLP**
- 1 x 8 (3/4 x 7-1/4) **XL XLP**
- 1 x 10 (3/4 x 9-1/4) **XL XLP**
- 1 x 12 (3/4 x 11-1/4) **XL XLP**

5/4 x S4S:

- 5/4 x 4 (1-1/8 x 3-1/2) **XL XLP**
- 5/4 x 6 (1-1/8 x 5-1/2) **XL XLP**
- 5/4 x 8 (1-1/8 x 7-1/4) **XL XLP**
- 5/4 x 10 (1-1/8 x 9-1/4) **XL XLP**
- 5/4 x 12 (1-1/8 x 11-1/4) **XL XLP**

V-GROOVE:

- 1 x 6 (3/4 x 5-1/2) **XLP**

EDGE & CENTER BEADS:

- 1 x 4 ECB (9/16 x 3-1/2) **XL XLP**
- 1 x 6 ECB (3/4 x 5-1/2) **XL XLP**

SHIPLAP:

- 1 x 6 (3/4 x 5-1/2) **XLP**
- 1 x 8 (3/4 x 7-1/4) **XLP**

PANELS & CAPS

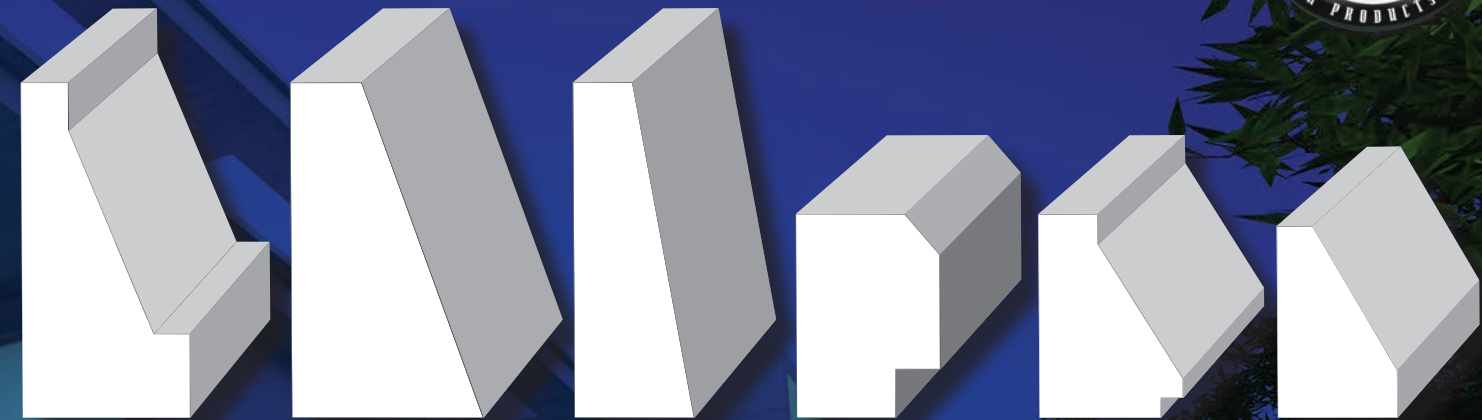

MSC175 7/8" x 1-3/4" **MCAP54** 1" x 1-3/4" **MCAP34** 5/8" x 1-3/4" **MCAP1** 3/4" x 1-1/16" **MCAP2** 3/4" x 1-1/16" **MCS1** 5/8" x 1"



MSC175 as cap, 1" x 8", 1/2" x 2" as Shoe Moulding



MCAP2 Cap, 1" x 6", MCS1 Shoe Moulding



MCAP34 Cap, 1" x 6", MCS1 Shoe Moulding



MCS1 Shoe used as cap, 1" x 6", MCS1 Shoe



MCAP1 Cap, 1" x 8", MCS1 Shoe Moulding



Casing: MCAP1 on 1x5, Base: MCAP1 on 1x8

EASED EDGE PROFILES
CASINGS

EASED EDGE PROFILES
BASES



WM412
11/16" x 3-1/2"



E2E432
9/16" x 3-1/2"



WM452
11/16" x 2-1/2"



WM472
9/16" x 2-1/2"



SAN725
9/16" x 7-1/4"



SAN525
9/16" x 5-1/4"



SAN414
9/16" x 4-1/4"



LWM412
11/16" x 3-1/2"



LWM432
9/16" x 3-1/2"

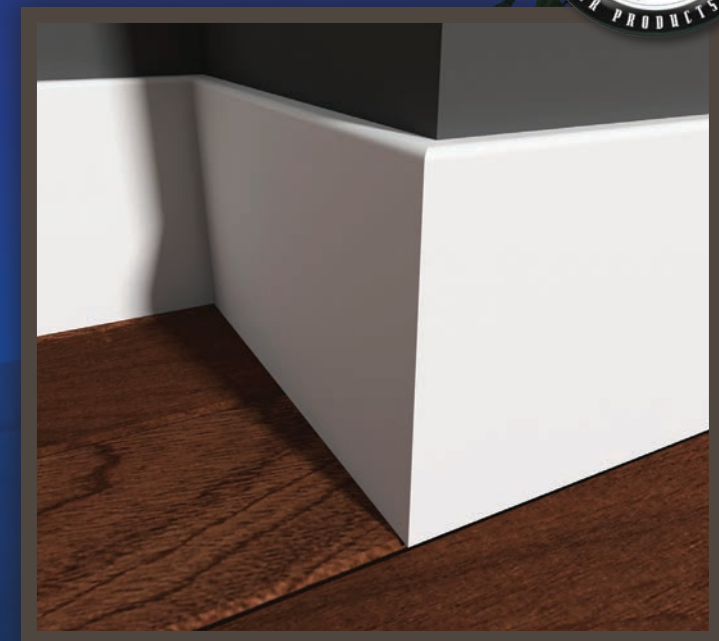

SAN725 Base



*Base, Panel & Cap: SAN525 Base, 1/4" x 1/4" Modern Groove 6" O.C., MSC175 Solid Crown, B8121
Window: MCC312 Casing, MCBB2 Back Band, LS6 Stool, MSC175 Solid Crown*



SOLID CROWNS



MSC275
1-3/8" x 2-3/4"

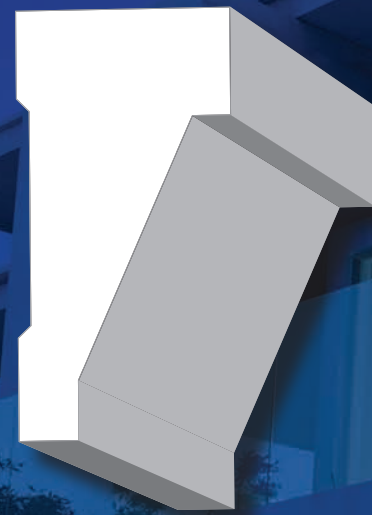

MSC225
1-1/8" x 2-1/4"

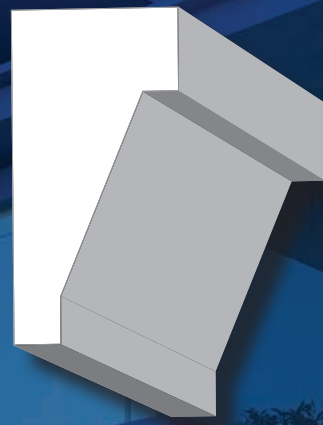

MSC175
7/8" x 1-3/4"



Cap: **MSC175 Solid Crown, B8121**
Window: **MCC312 Casing, MCBB2 Back Band, LS6 Stool, MSC175 Apron**

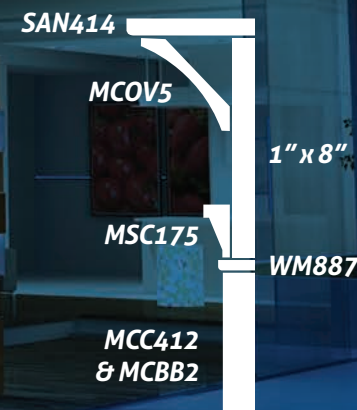

COVES

COVE BUILD UPS

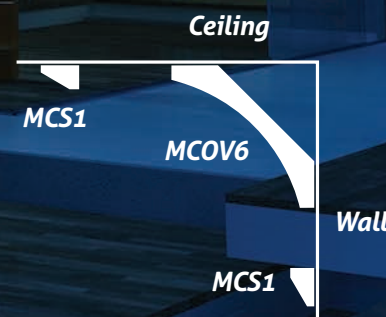
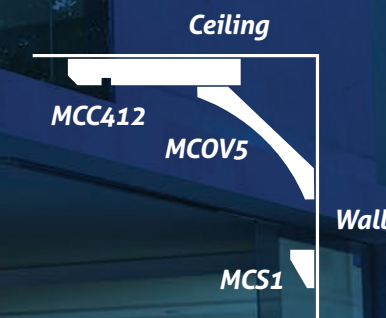
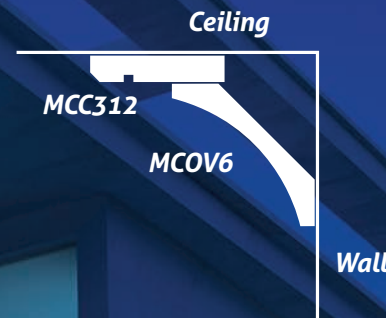
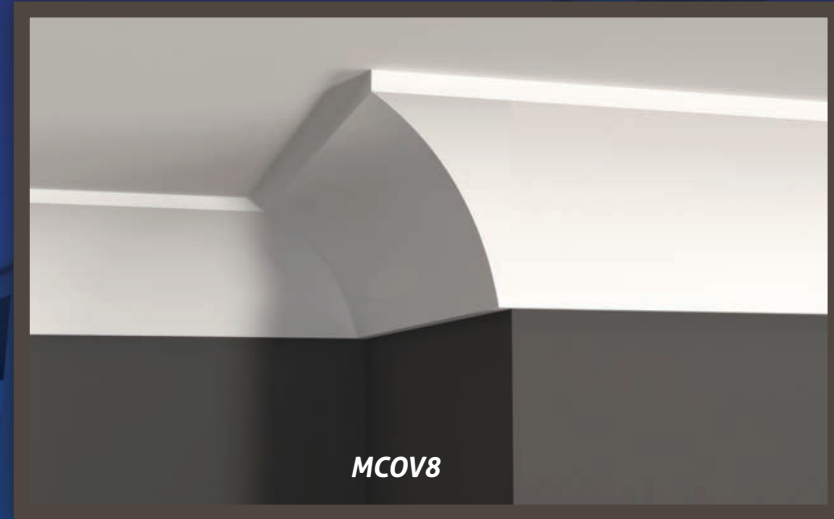

MCOV8

1-1/8" x 7-1/4"

Projection: 5-1/16" Height: 5-1/16"

MCOV6

1-1/8" x 5-1/4"

Projection: 3-5/8" Height: 3-5/8"

MCOV5

3/4" x 4-1/4"

Projection: 3" Height: 3"

STEP COVES



MCR514, MCC312



MCR514 Ceiling Step



MCR514 Wall Step



MCR714
1-1/16" x 7-1/4"

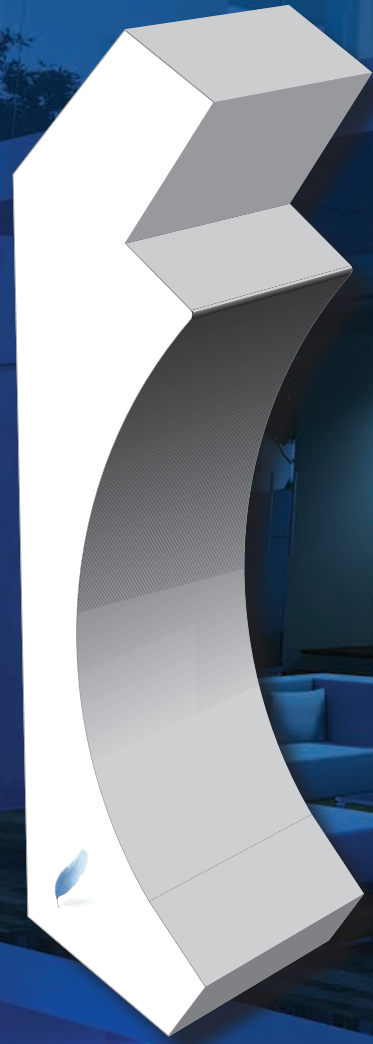

MCR514
1-1/16" x 5-1/4"

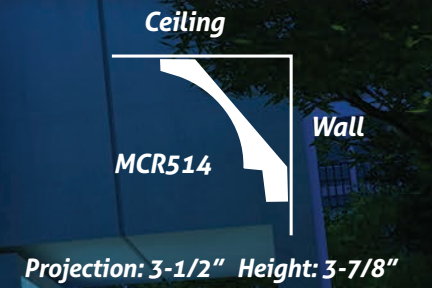

MCR714 Ceiling Step



MCR714 Wall Step

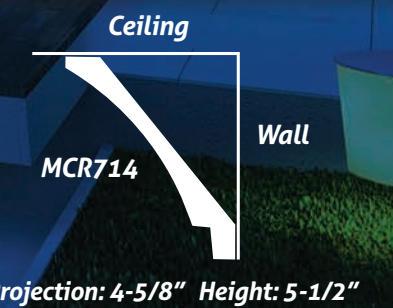
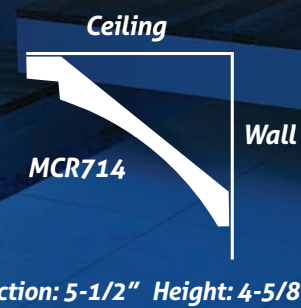



CROWNS



MCR750

1-1/8" x 7-1/2"
Projection: 5-1/4"
Height: 5-1/4"

MCR650

1-1/8" x 6-1/2"
Projection: 4-5/8"
Height: 4-5/8"

MCR550

1-1/8" x 5-1/2"
Projection: 3-7/8"
Height: 3-7/8"



MCR550 Ceiling Step



MCR550 Wall Step



MCR650 Ceiling Step



MCR650 Wall Step



MCR750 Ceiling Step



MCR750 Wall Step

Add our Metro Caps & Panels to our crowns
for an endless array of design details

CROWN BUILD UPS

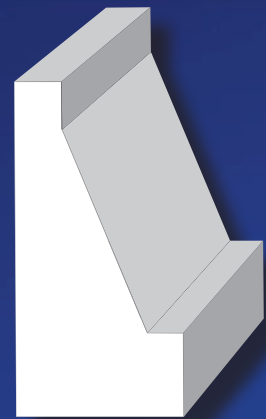

MSC175
7/8" x 1-3/4"



MCAP34
5/8" x 1-3/4"



MCAP1
3/4" x 1-1/16"



MCAP2
3/4" x 1-1/16"



MCS1
5/8" x 1"

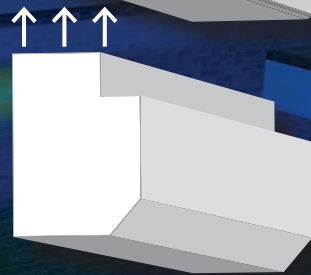
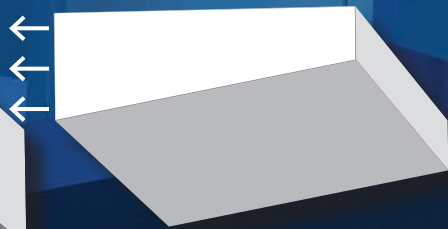

MCR550 Step on Wall, MCAP1

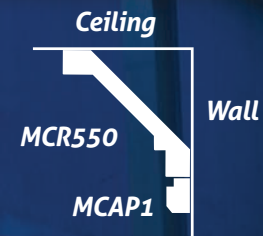

MCR550 Step on Ceiling, MCAP1



MCR550 Step on Wall, MCAP1 Bottom, MCAP34 on Top

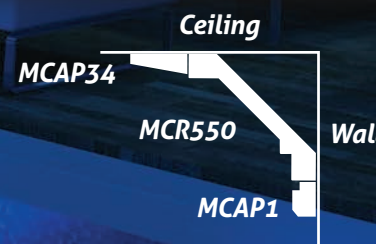

MCR550 Step on Wall, MCAP1, MCC412

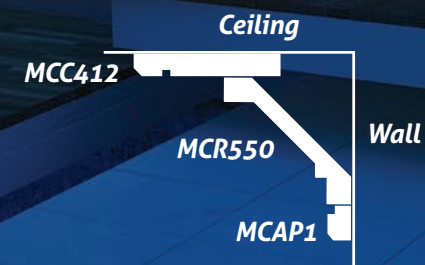

MCR550 Step on Ceiling, MCAP1, MCC412

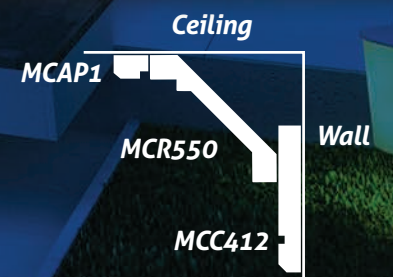



MCR650 Step on Ceiling, MCAP1



MCR650 Step on Wall, MCAP1

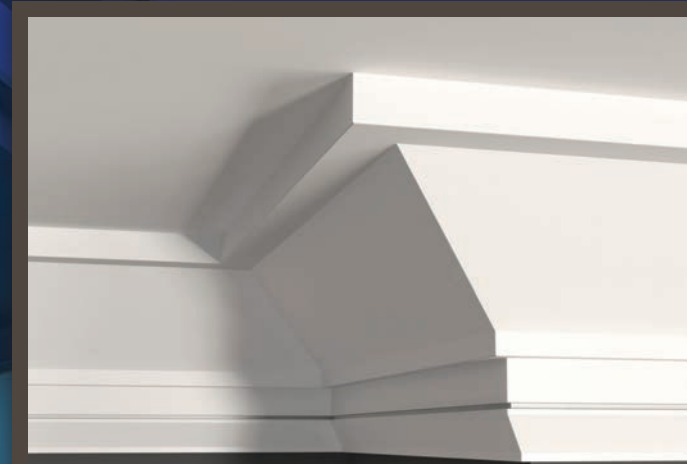

MCR650 Step on Wall, MCAP2



MCR650 Step on Ceiling, MCAP2

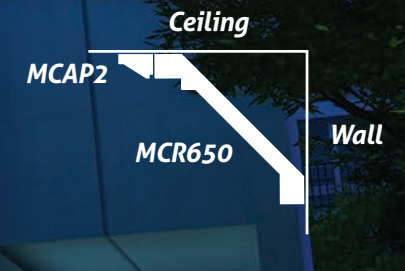
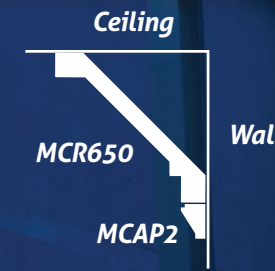
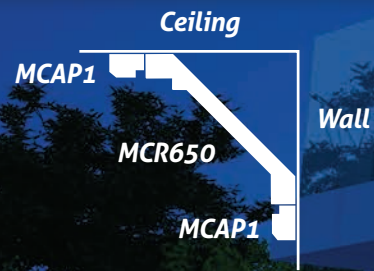

MCR650 Step on Ceiling, MCAP1



MCR650 Step on Wall, MCAP1



MCR650 Step on Ceiling, MSC175, MCS1



MCR650 Step on Wall, MSC175, MCS1

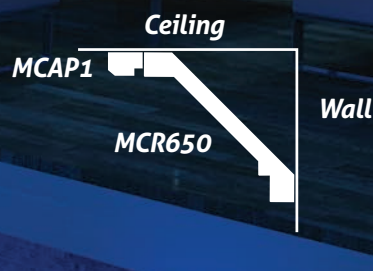
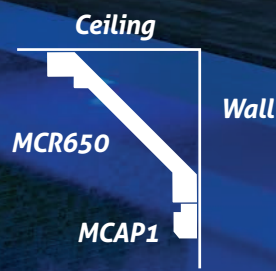



MCR650 Step on Ceiling, MCAP34



MCR650 Step on Wall, MSC175, MCAP1



MCR750 Step on Ceiling, MCAP1, MCS1



MCR750 Step on Wall, MCAP1, MCS1

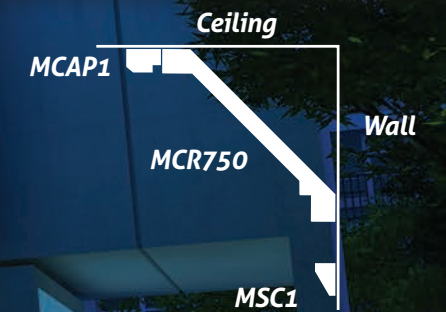
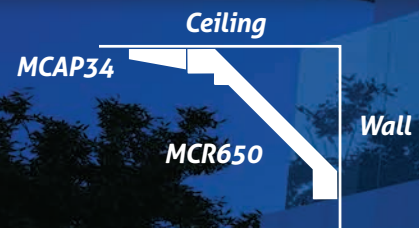

MCR750 Step on Wall, MCAP34



MCR750 Step on Wall, MSC175



MCR750 Step on Ceiling, MCAP34



MCR750 Step on Wall, MCAP34

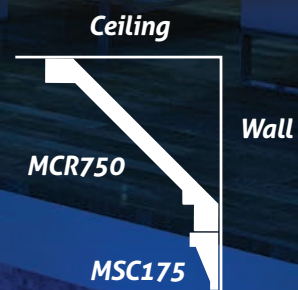
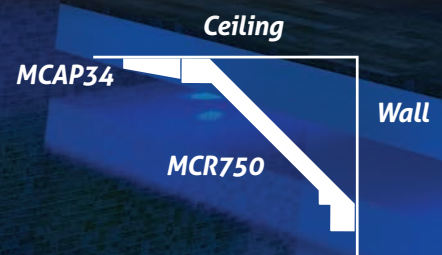

CAPS
USED IN PANEL APPLICATIONS

CAPS
USED IN PANEL APPLICATIONS



MCAP54, MCS1, 1"x6", 1"x12"

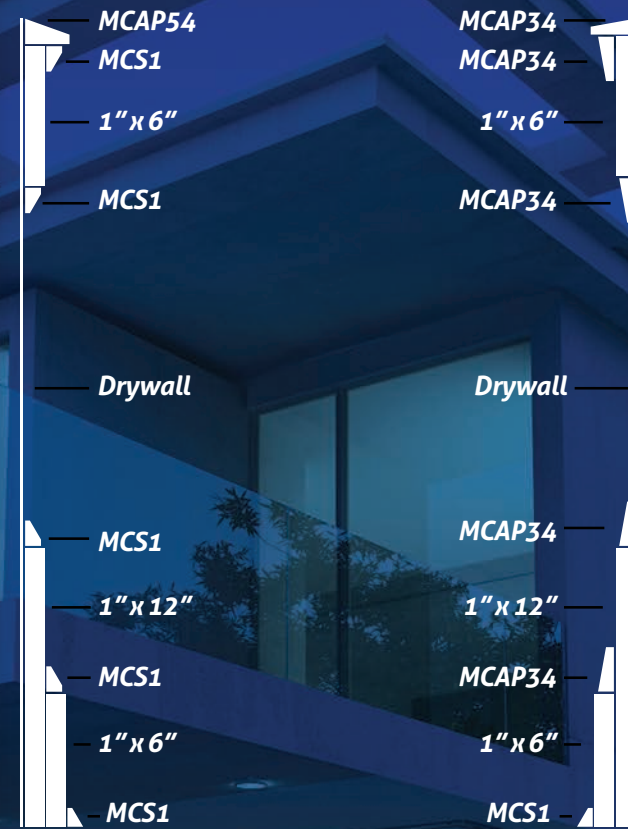

MCAP34, 1"x6", 1"x12"

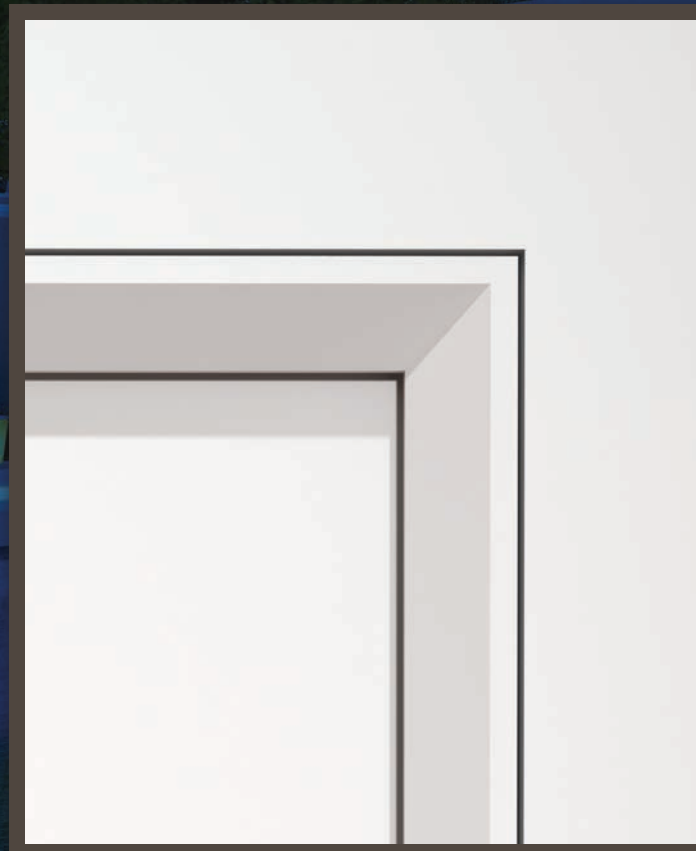

MCS1 used as a panel moulding



MCAP54 & MCS1 used as a panel cap



MCS1 Shoe used as a base cap, 1"x6", MCS1 shoe



MCAP34 used as a panel cap



MCAP34 used as a base cap, 1"x6", MCS1 shoe

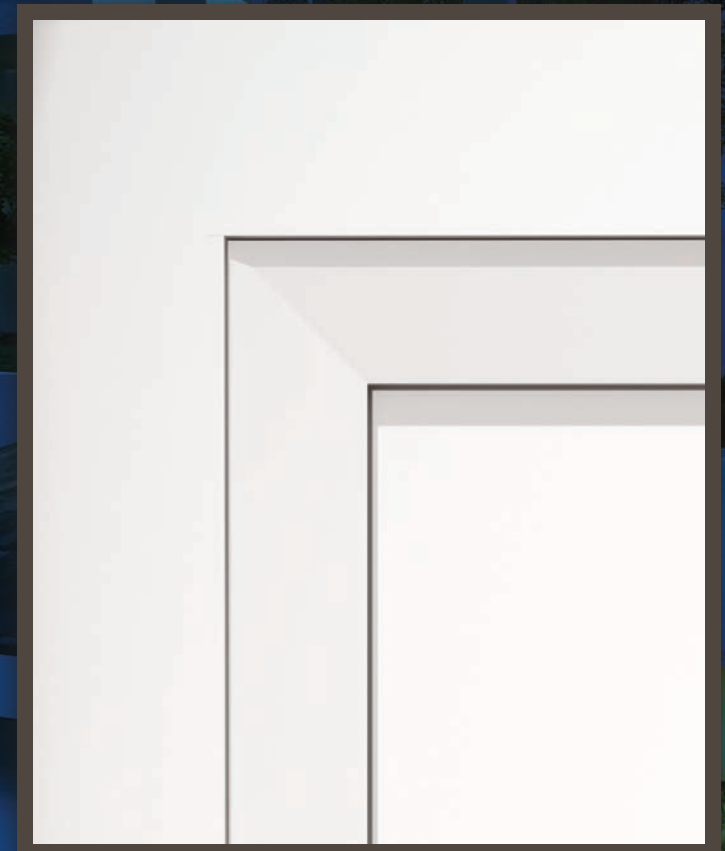

MCAP34 used as a panel moulding

CAPS
USED IN PANEL APPLICATIONS

CAPS
USED IN PANEL APPLICATIONS



S12, MSC175, MCAP2, MCS1, 1"x8", 1"x12"

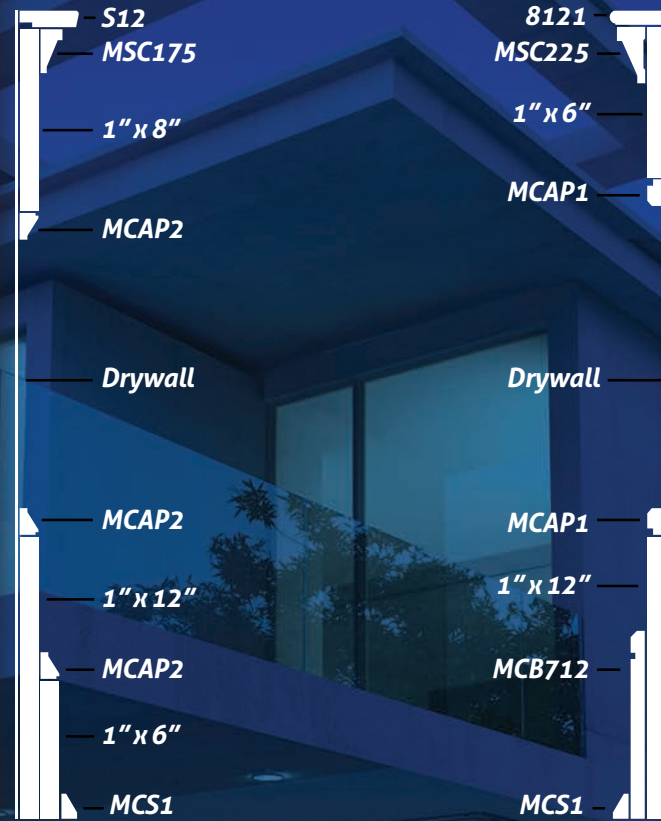

8121, MSC225, MCAP1, MCB712, MCS1, 1"x6", 1"x12"



MCAP2 used as a panel moulding

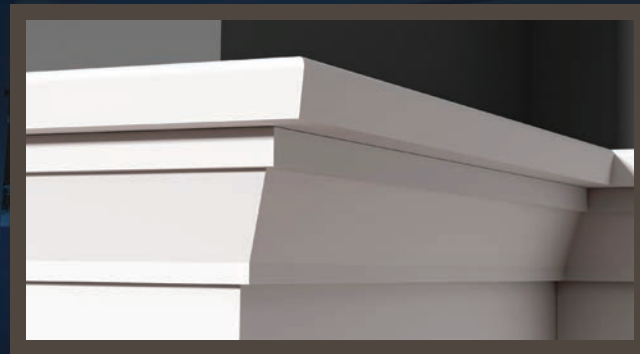

S12 & MSC175 used as a panel cap



8121 & MSC225 used as a panel cap



MCAP2 used as a base cap, 1"x6", MCS1 shoe



MCB712, MCS1 shoe

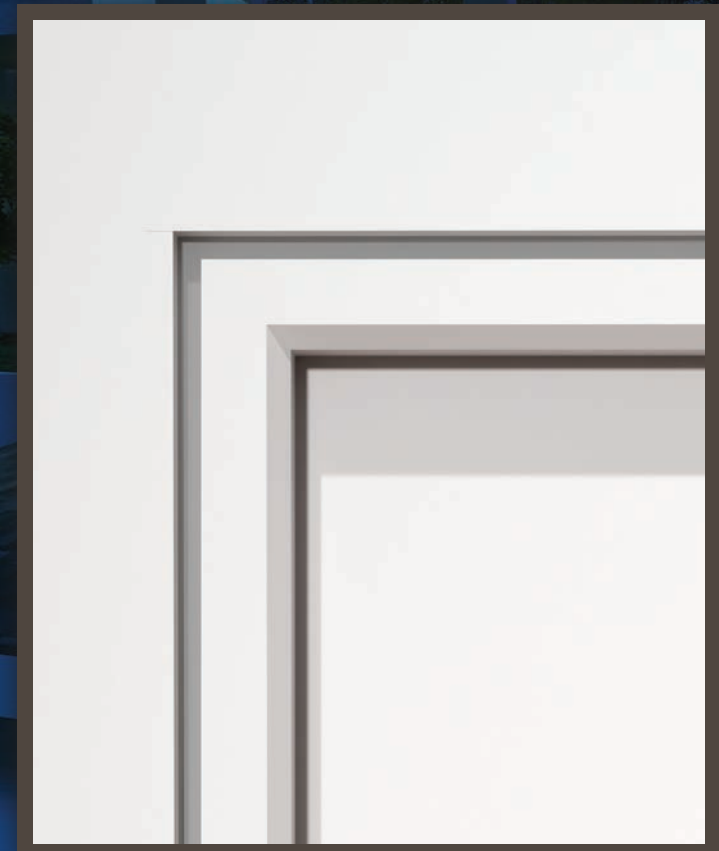

MCAP1 used as a panel moulding

CAPS
USED IN PANEL APPLICATIONS



MSC175, MCAP2, MCS1, 1"x3", 1"x4", 1"x5", 1"x6", 1"x10"

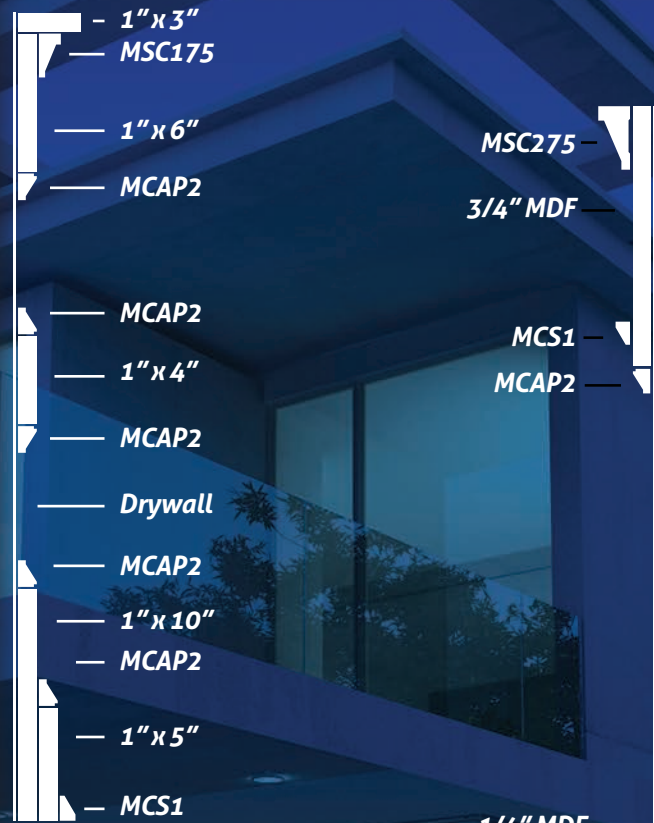

- 1"x3" MSC175
- 1"x6" MCAP2
- 1"x4" MCAP2
- 1"x4" MCAP2
- Drywall
- 1"x10" MCAP2
- 1"x5" MCS1
- 1/4" MDF
- 3/4" MDF MSC275
- 3/4" MDF MCS1
- 1/4" MDF MCAP2

PANELS & CAPS
USED IN COLUMN APPLICATIONS



- MCC575
- 3/4" MDF
- MCAP2

1/4" MDF



- MCAP2
- 3/4" MDF
- MSC175
- 1"x8"
- 1/2"x3"



MCAP2 used as a panel moulding

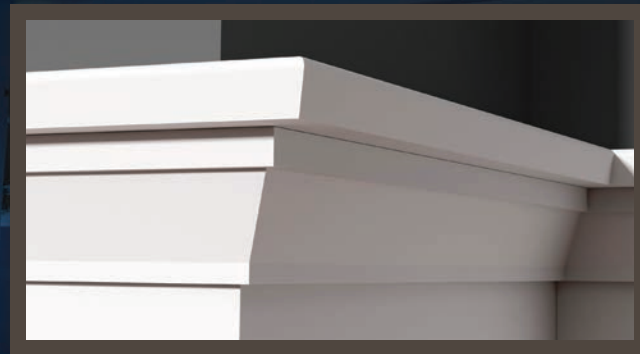

1"x3" & MSC175 used as a panel cap



MCAP2 used as a base cap, 1"x5", MCS1 shoe

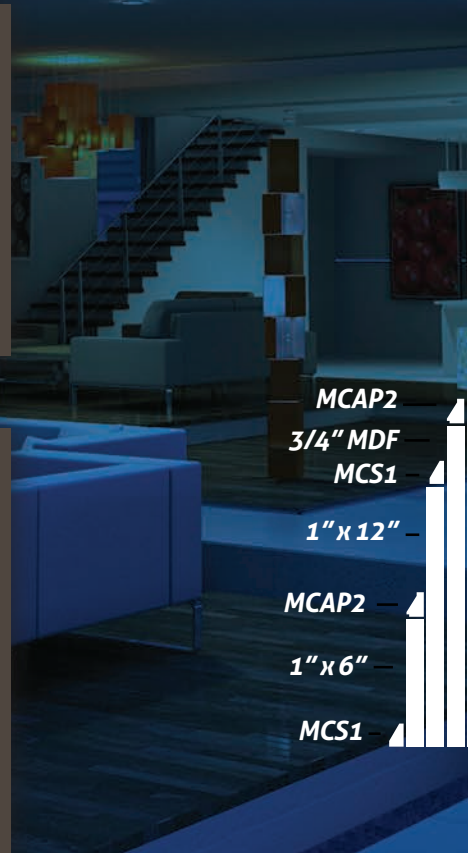

- MCAP2
- 3/4" MDF
- MCS1
- 1"x12"
- MCAP2
- 1"x6"
- MCS1



Crown: MCR650 with MCAP1

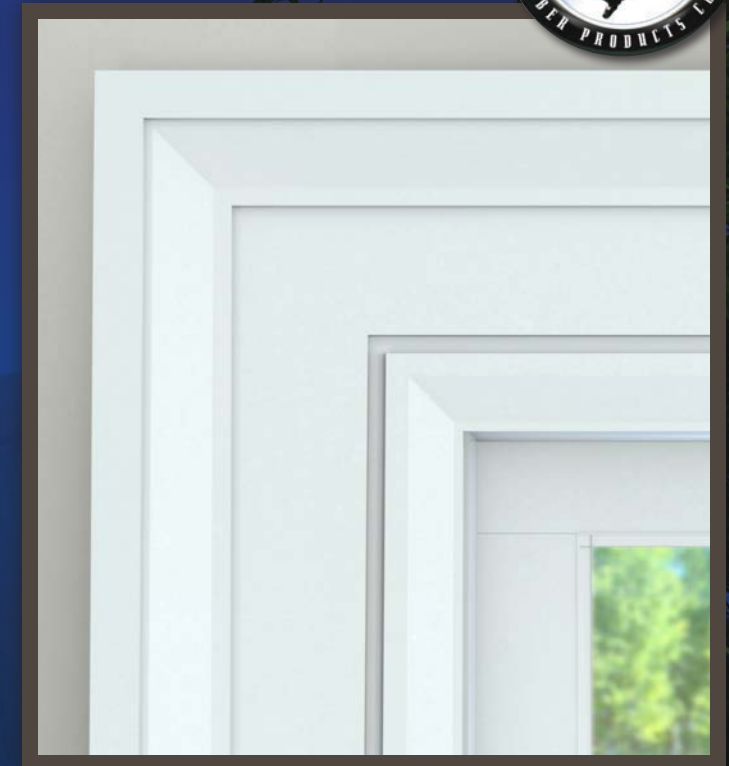

Exterior Door Casing: MCC475



Chair Rail: MCC575



Base: 1x8, MSC175 with 1/2" x 3" as Shoe Moulding

*Crown: MCR650 with MCAP1, Panels: MCAP2, Chair Rail: MCC575
Base: 1x8, MSC175 with 1/2" x 3" as Shoe Moulding, Columns: MCC575, MCAP2
Arch: MCC412 with MCBB2, Exterior Door Casing: MCC475*



Crown: MCAP34, MCR750, MCAP1



Door & Window Headers: 1"x8", MCOV5, MSC175, SAN414, WM887



Paneling: MCS1 with 1"x6", Base: MCAP34, 1"x6"



Fireplace Mantle: MCOV5, MCAP2, MCS1, 1"x3"

Casing: MCC412 with MCBB1, Door and Window Headers: 1"x8", MCOV5, MSC175, SAN414, WM887
Crown: MCAP34, MCR750, MCAP1, Chair Rail: MCS1 with MCAP34, Fireplace Mantle: MCOV5, MCAP2, MCS1, 1"x3"
Paneling: MCS1 with 1"x6", Base: MCAP34, 1"x6"

All Profiles Stocked in Primed FJ Pine | Indicates Profiles Also Available In Primed Ultralite MDF



Crown: MCOV8 Crown with MCAP1 on 1"x6", Casing: MCAP1 on 1"x5", Base: MCAP1 on 1"x8"



Crown: MCOV8 Crown with MCAP1 on 1"x6"



Base: MCAP1 on 1"x8"



Casing: MCAP1 on 1"x5", Sill: LS6



Casing: MCAP1 on 1"x5", Base: MCAP1 on 1"x8"



Coffered Ceiling: DCR734, S4S

Mantel: DCR558 crown, S4S board, SC134, 8577 quarter round, DCB825

Base: DCB825, Casing: DC512, Apron: 1"x3" S4S, Stool: LS6

CASINGS

THERE IS A CROSSROADS WHERE SOPHISTICATION OF MOULDING DESIGN intersects with the highest quality material and millwork craftsmanship. It is in this space that *The DESIGNER COLLECTION* was born...

The DESIGNER COLLECTION is a compilation of 24 distinct profiles that are as substantial in size as they are in the design possibilities they offer.

Comprised of the highest grade FJ Poplar substrate and coated with our proprietary 4 step priming system, *The DESIGNER COLLECTION* is meticulously manufactured to be the highest quality Moulding product available in the market today.

With a robust inventory of **18' mouldings** and 16' S4S boards, as well as our custom run and arched millwork capabilities, we can accommodate the most intricate fabrications your imagination can create...

- **18' LONG PRIMED POPLAR MOULDINGS**
 - › *minimizes waste on casings*
 - › *minimizes seams on bases and crowns*
- **IMMACULATE MILLING AND 4-STEP PRIMING SYSTEM (DOUBLE PRIMED AND DOUBLE BUFFED)**
- **CUSTOM RUN OUR DESIGNER COLLECTION PATTERNS IN ANY HARDWOOD SPECIES**
- **CUSTOM RUN YOUR OWN MOULDING PROFILES IN PRIMED POPLAR OR ANY HARDWOOD SPECIES**
- **SPECIAL ORDER FOR ANY ARCHED CASING OR CURVED CROWN APPLICATION**



DC400



DC412



DC450



DC400
1-5/16" x 4"
18' Lengths

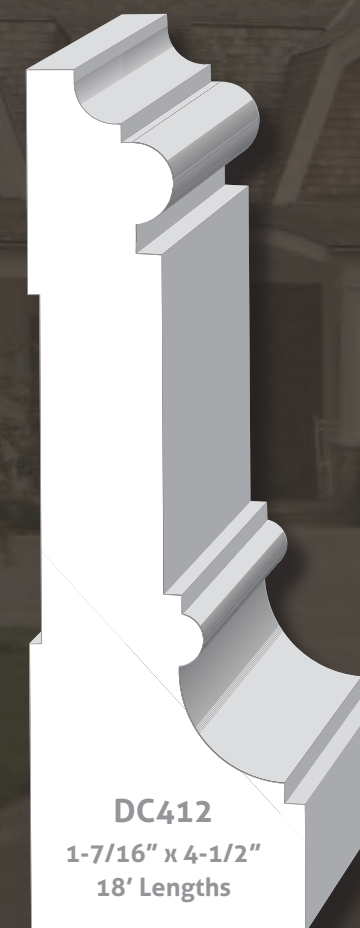

DC412
1-7/16" x 4-1/2"
18' Lengths



DC450
1-5/8" x 4-1/2"
18' Lengths

CASINGS



DCWC5



DCLK5



DC499

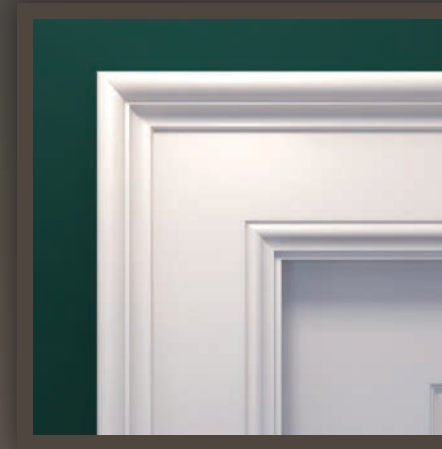

DCAS5



DC512



DC550



DCWC5
1-1/2" x 4-7/8"
18' Lengths



DCLK5
1-1/2" x 5"
18' Lengths

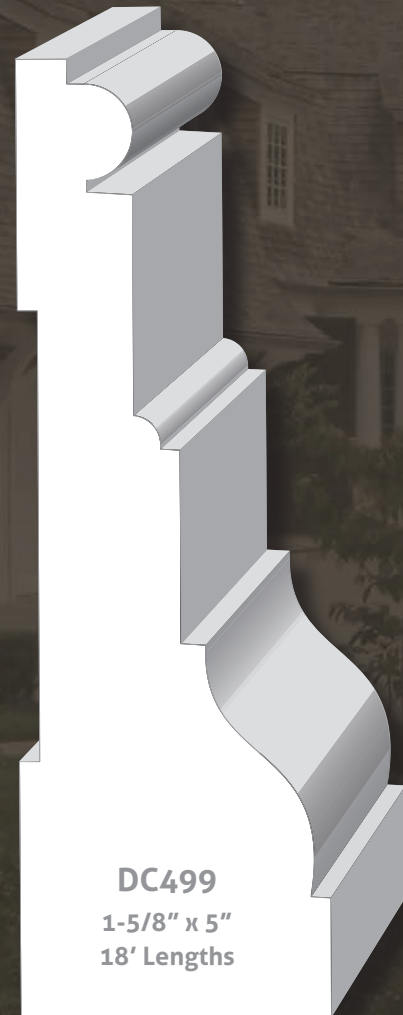

DC499
1-5/8" x 5"
18' Lengths



DCAS5
1-3/4" x 5-1/2"
18' Lengths
* Also used as Chair Rail

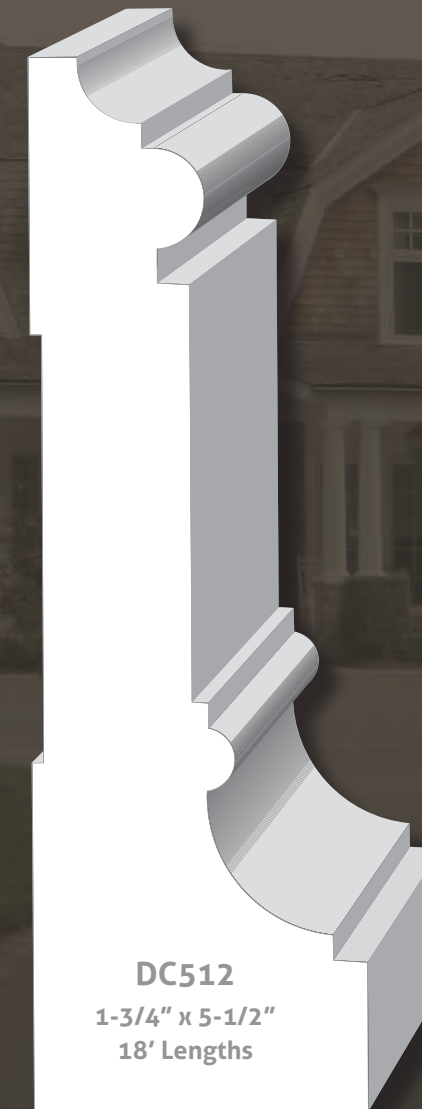

DC512
1-3/4" x 5-1/2"
18' Lengths

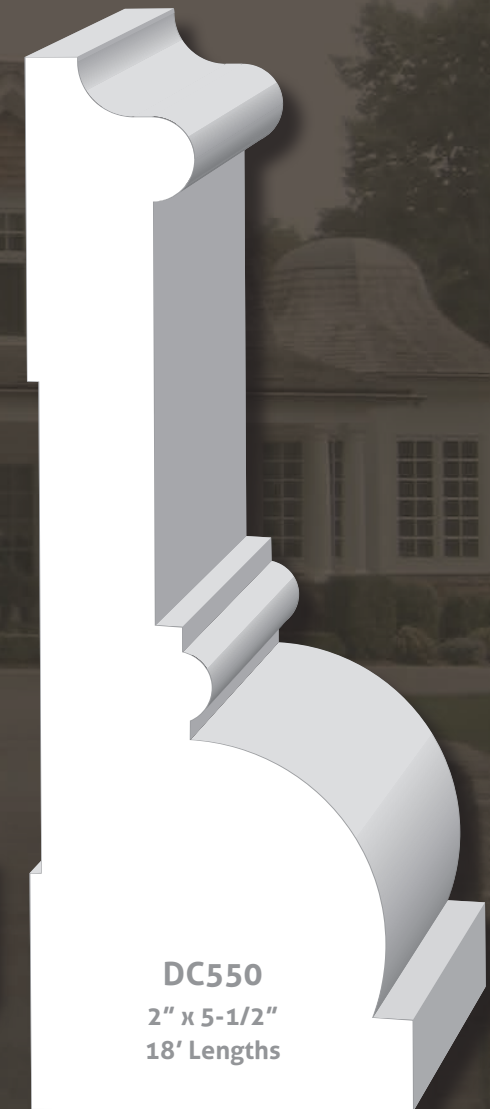

DC550
2" x 5-1/2"
18' Lengths

BASES



DCB525
13/16" x 5-1/4"
18' Lengths

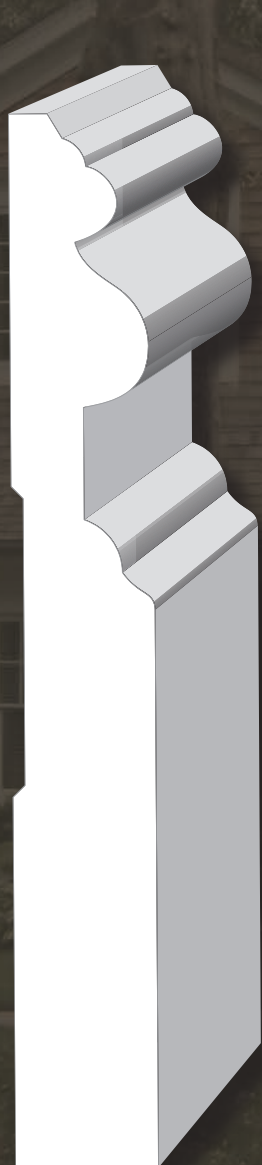

DCBB5
3/4" x 5-1/2"
18' Lengths



DCB534
13/16" x 5-3/4"
18' Lengths

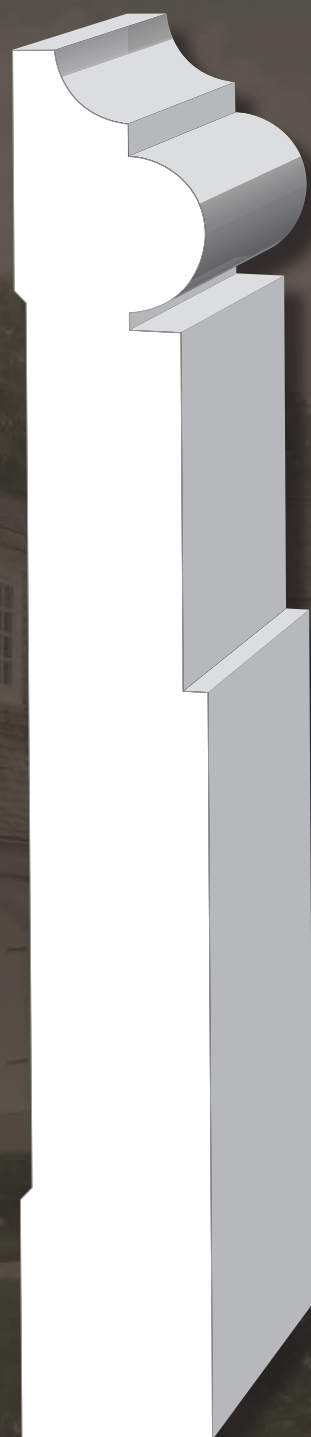

DCB714
1" x 7-1/4"
18' Lengths



DCB525



DCBB5



DCB534

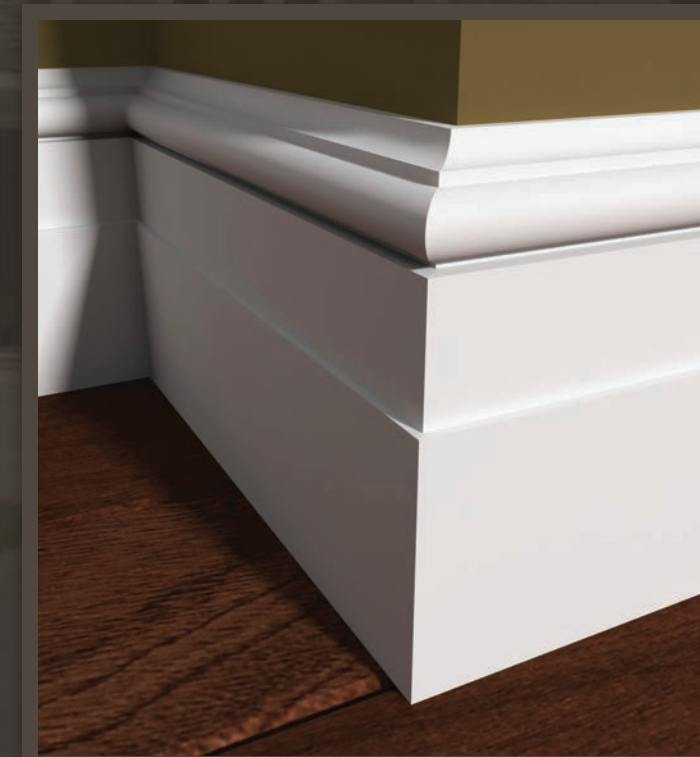

DCB714



DCB775
1-1/16" x 7-3/4"
18' Lengths

DCB8
1" x 8"
18' Lengths

DCB825
1-5/16" x 8-1/4"
18' Lengths

DCB925
7/8" x 9-1/4"
18' Lengths

DCB775

DCB8

DCB825

DCB925

CHAIR RAIL,
BASES & CASINGS

BASES & CASINGS



DCAS5
1-3/4" x 5-1/2"
18' Lengths

DCAS5 used as a Chair Rail



DC499 Casing and DCB714 Base



DC512 Casing and DCB925 Base



DC400 Casing and DCB525 Base



DC412 Casing and DCB775 Base



DC550 Casing and DCB825 Base



DCAS5 Casing and DCB8 Base



DC412 Casing and DCBB5 Base



DC450 Casing and DCB8 Base



DCLK5 Casing and DCB775 Base



DCWC5 Casing and DCB534 Base

COVES/CROWNS



DCR512
13/16" x 5-1/2"
18' Lengths
Projection: 4" Height: 3-7/8"

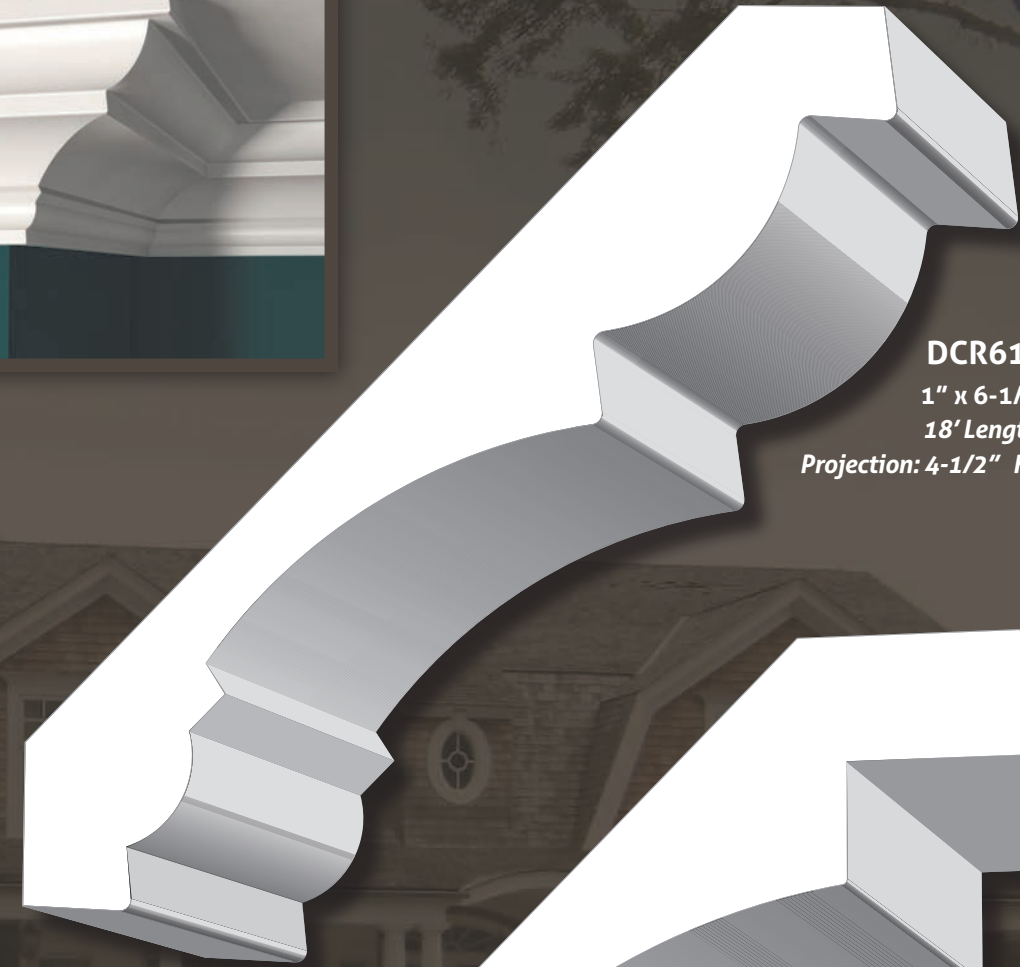
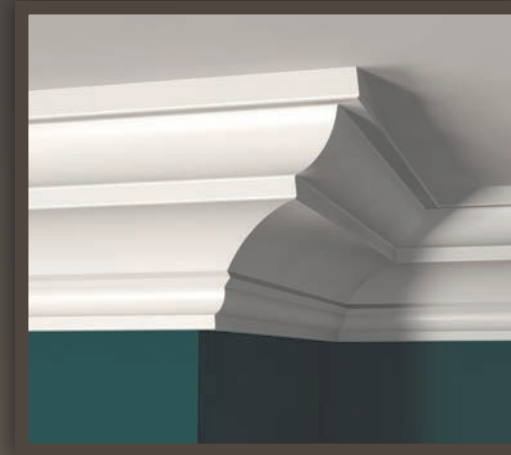

DCR612
1" x 6-1/2"
18' Lengths
Projection: 4-1/2" Height: 4-3/4"



DCR558
1-5/16" x 5-5/8"
18' Lengths
Projection: 4" Height: 4"



DCR634
1-3/4" x 6-3/4"
18' Lengths
Projection: 4-1/2" Height: 5-1/8"

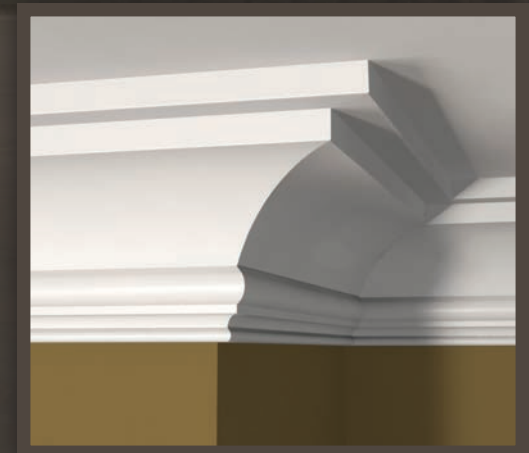

COVES/CROWNS



DCR725
1-5/16" x 7-1/4"
18' Lengths
Projection: 5-1/4"
Height: 5-1/8"

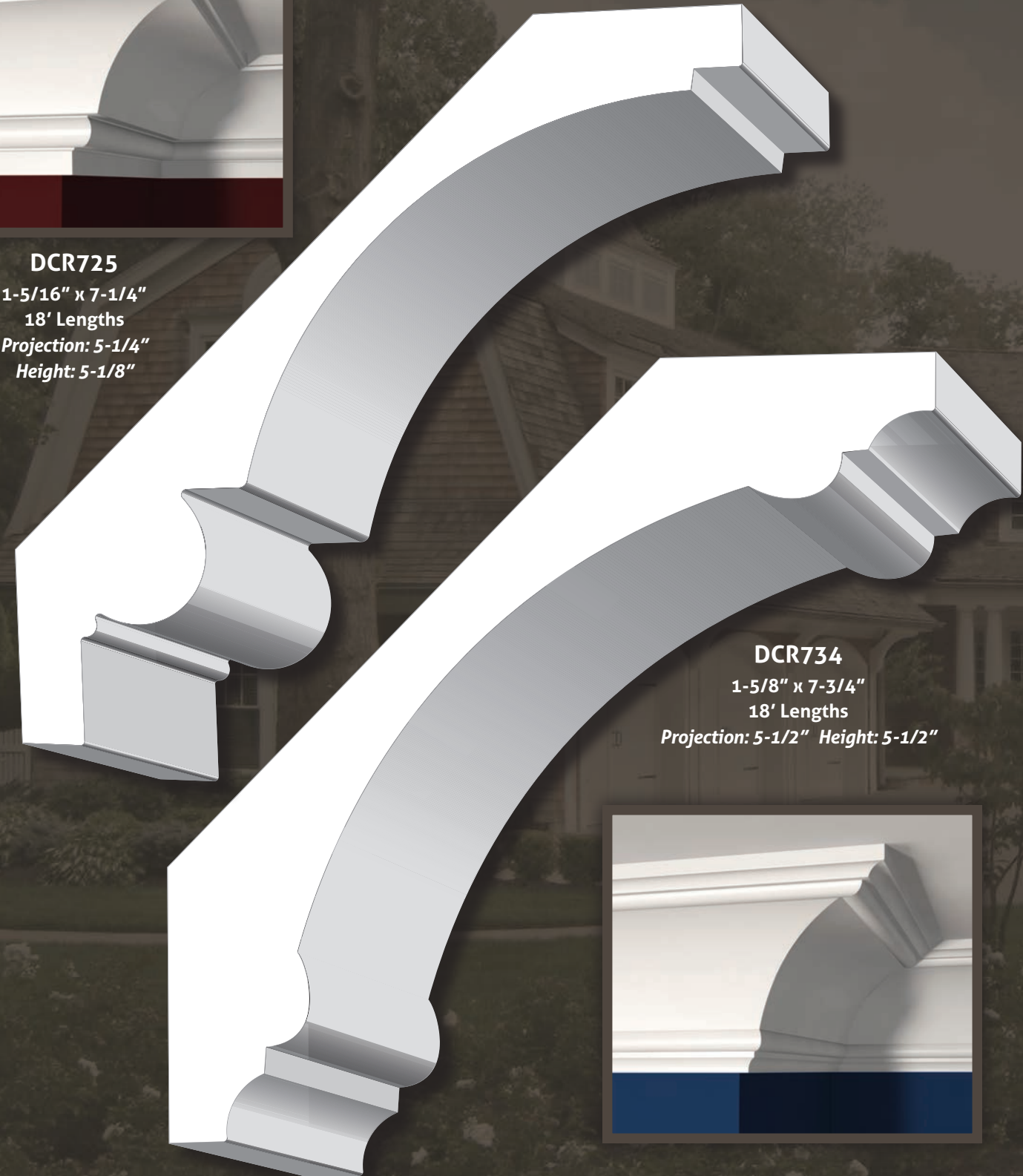

DCR734
1-5/8" x 7-3/4"
18' Lengths
Projection: 5-1/2" Height: 5-1/2"

COVES/CROWNS

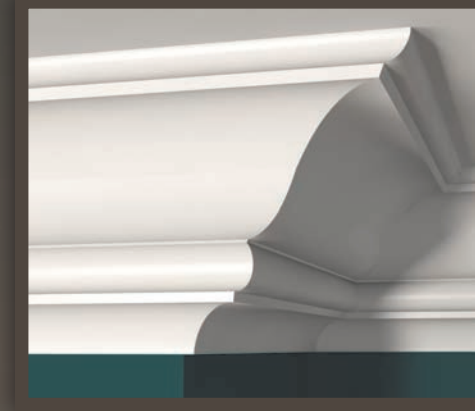

DCR814
1-5/16" x 8-1/4"
18' Lengths
Projection: 6-1/8" Height: 5-1/2"

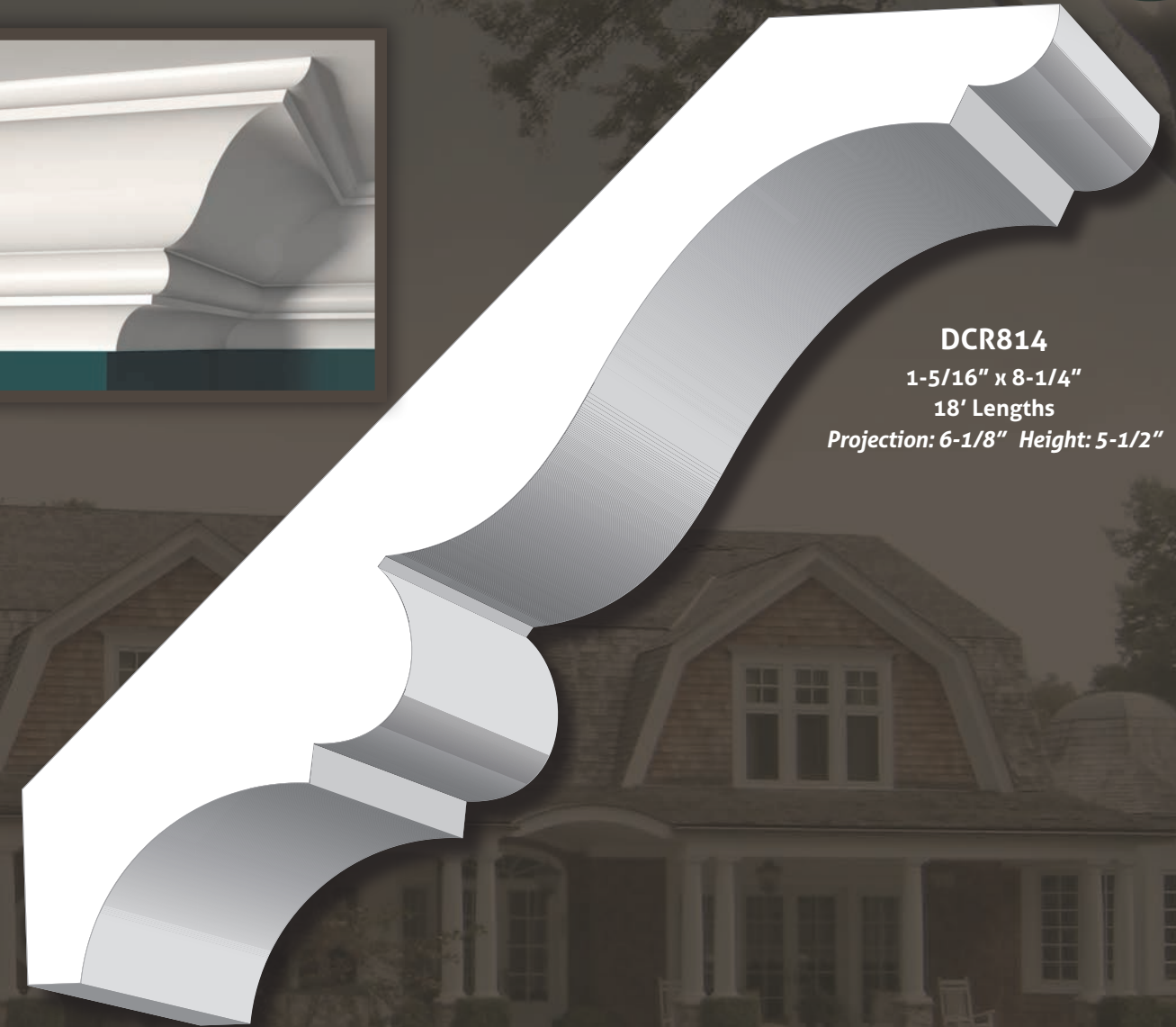

PRIMED POPLAR S4S

NOMINAL SIZE	ACTUAL SIZE	SKU	NOMINAL SIZE	ACTUAL SIZE	SKU
1 x 3	3/4 x 2-1/2	D13POP-PRF			
1 x 4	3/4 x 3-1/2	D14POP-PRF	5/4 x 4	1 x 3-1/2	D544POP-PRF
1 x 6	3/4 x 5-1/2	D16POP-PRF	5/4 x 6	1 x 5-1/2	D546POP-PRF
1 x 8	3/4 x 7-1/4	D18POP-PRF	5/4 x 8	1 x 7-1/4	D548POP-PRF
1 x 10	3/4 x 9-1/4	D110POP-PRF	5/4 x 10	1 x 9-1/4	D5410POP-PRF
1 x 12	3/4 x 11-1/4	D112POP-PRF	5/4 x 12	1 x 11-1/4	D5412POP-PRF
1 x 16	3/4 x 15-1/4	D116POP-PRF			
1 x 24	3/4 x 23-1/4	D124POP-PRF			

PRIMED POPLAR
Primed 4 sides - 16' lengths
5/4" boards are 1" full thickness

DOOR JAMBS - INTERIOR

SOLID PINE FLAT JAMBS

SKU#	SIZE (DEPTH X WIDTH)	BELOW DADO	OVERALL LENGTH
JL491	11/16 x 4-5/8	81-1/2"	82-15/16"

specs (3/4" lug, 5/16 dado depth, 1/32 back bevel)

PRIMED FINGERJOINT FLAT JAMBS

SKU#	SIZE (DEPTH X WIDTH)	BELOW DADO	OVERALL LENGTH
JL358PRF	11/16 X 3-5/8	81-1/2"	82-15/16"
JL458PRF	11/16 x 4-5/8	81"	82-7/16"
JL458PRF-NL (NO LUG)	11/16 x 4-5/8	81"	81-11/16"
JL491PRF	11/16 x 4-5/8	81-1/2"	82-15/16"
JL491PRF - 7	11/16 x 4-5/8	85-1/2"	86-15/16"
JL491PRF - 8	11/16 x 4-5/8	97-1/2"	98-15/16"
JL478PRF	11/16 x 4-7/8	81-1/2"	82-15/16"
JL478PRF - 7	11/16 x 4-7/8	85-1/2"	86-15/16"
JL478PRF - 8	11/16 x 4-7/8	97-1/2"	98-15/16"
JL538PRF	11/16 x 5-3/8	81-1/2"	82-15/16"
JL691PRF	11/16 x 6-5/8	81-1/2"	82-15/16"
JL691PRF - 8	11/16 x 6-5/8	97-1/2"	98-15/16"
JL678PRF - 8	11/16 x 6-7/8	97-1/2"	98-15/16"

specs (3/4" lug, 5/16 dado depth, 1/32 back bevel)

THE Hardwoods COLLECTION



INTRODUCING

Garden State Lumber's Quick Ship & Custom Run Hardwood Moulding Programs

QUICK SHIP PROGRAM:

- ✦ The profiles depicted on the following pages are available in 3 weeks or sooner.
- ✦ Poplar ■ Red Oak ■ Maple
Cherry ■ Sapele (Mahogany)
- ✦ No minimum quantities required

CUSTOM RUN PROGRAM:

- ✦ ALL Garden State Lumber Moulding Profiles can be custom run in most hardwood and softwood species
- ✦ 4 week lead time or sooner
- ✦ No minimum quantities required
- ✦ Custom arches, half rounds, ellipsicals, full rounds, and ovals are available

Profiles are available in 3 weeks or sooner.
Custom runs are available in 4 weeks or sooner.



CROWNS



UC31H
3/4 x 3-3/4



UC41H
3/4 x 4-5/8



UC51H
13/16 x 5-5/8



UC71H
1-1/16 x 7-1/4

NECK



8535H
5/8 x 3/4



COV412H
1-1/16 x 4-1/2



CRW2H
11/16 x 2

L8010H
3/4 x 2-1/2

L8009H
11/16 x 3-1/2

8013H
11/16 x 4-1/2

8027H
11/16 x 5-1/4



SC134H
3/4 x 1-3/4

SOLID CROWNS



SC214H
1-1/8 x 2-1/4



SC234H
1-3/8 x 2-3/4

ALL PROFILES AVAILABLE IN



All Garden State Lumber moulding profiles can be custom run in most hardwood species

Profiles are available in 3 weeks or sooner.
Custom runs are available in 4 weeks or sooner.



BB5H
3/4 x 5

BB7H
3/4 x 7

BASES

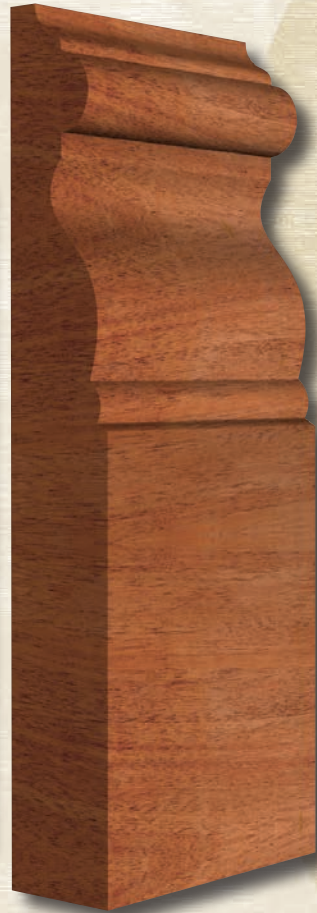

BB458H
1 1/16 x 4-5/8



8712H
1 1/16 x 3-1/2

BASE CAPS

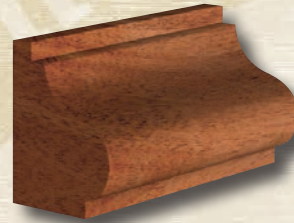

BC78H
1 1/16 x 7/8



WM164H
1 1/16 x 1-1/8

LWM163H
1 1/16 x 1-5/8



8412H
1 1/16 x 1-3/8



8416H
1 1/16 x 1-5/8

CASINGS



GS419H
1-1/16 x 4-1/2



WC1H
1-1/16 x 3-5/8



B8746H
1 1/16 x 3-5/8



GS119H
7/8 x 3-1/2

SHOE/FLOOR MOULDINGS

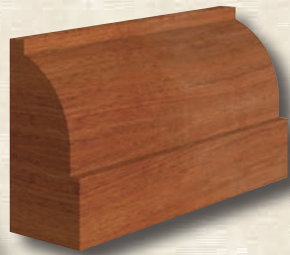

SH1H
1/2 x 1



SH78H
1/2 x 7/8

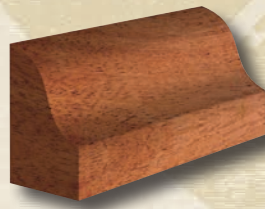

8423H
1/2 x 3/4



8422H
1/2 x 3/4



L8753H
1 1/16 x 3-1/2



LWM445H
1 3/16 x 3-3/8

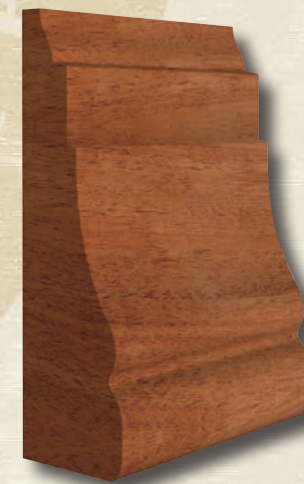

8753H
1 1/16 x 2-1/2



WM376H
1 3/16 x 2-3/8

ALL PROFILES AVAILABLE IN



All Garden State Lumber moulding profiles can be custom run in most hardwood species

QUICK SHIP

Profiles are available in 3 weeks or sooner.
Custom runs are available in 4 weeks or sooner.



PANEL MOULDINGS

CHAIR RAILS



CR314H
3/4 x 3-1/4



ES7H
1-1/8 x 3-1/8



LWM297H
3/4 x 2-3/4



LWM135H
3/8 x 7/8



WM130H
7/16 x 1-1/8

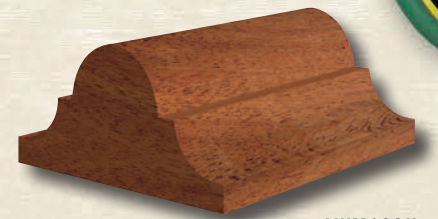

LWM133H
3/4 x 1-1/2



PL2H
11/16 x 2

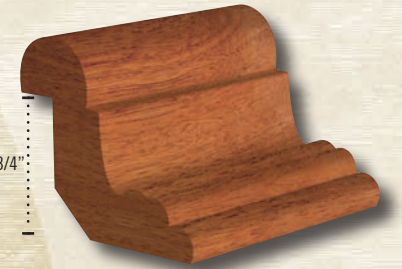

RPL34H
3/4 x 1-13/16

NOSE AND COVES

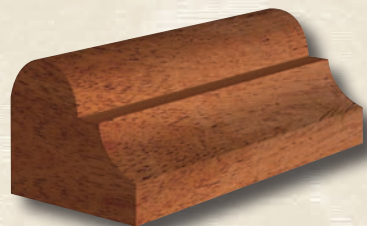

8575H
3/8 x 1/2

8577H
5/8 x 3/4

8578H
11/16 x 1-1/8

QUARTER ROUNDS



8063H
1/2 x 1/2

8065H
3/4 x 3/4

COVES



WP101H
1/2 x 1/2

WM93H
3/4 x 3/4

8024H
9/16 x 1-5/8

CV278H
13/16 x 2-7/8

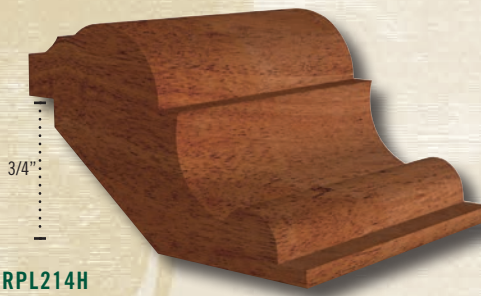

RPL214H
13/16 x 2-1/4



PLP312H
1-3/16 x 3-1/2

HALF ROUNDS



HR12H
1/4 x 1/2

HR34H
3/8 x 3/4

HR1H
1/2 x 1

HR15H
3/4 x 1-1/2

HR2H
1 x 2

HR3H
1-1/2 x 3

FLAT STOOLS



FS312H
1 x 3-1/2

F1021H
1 x 5-1/2

STOP MOULDINGS



G8090H
3/8 x 2-1/2



D8090H
3/8" x 1-3/8



Please see page 169 for our full offering of hardwood S4S boards.

ALL PROFILES AVAILABLE IN



CUSTOM ARCHES

& Architectural Accents

- Available in Primed MDF, PVC, most hardwood species
- 3/16" Reveal will be added to all supplied measurements & templates

ARCH CASINGS

- Reveal can be adjusted upon specification
- Most casings for Andersen units can be manufactured by Andersen unit number

ELLIPTICALS

SHOWN: ES1 EASTERN WHITE PINE



TEMPLATE REQUIRED

Measurement Required: \triangle Measurement Only – Inside Width Jamb to Jamb

Elliptical units require a template of the jamb supplied on Red Rosin paper, Tyvek, or any flat surface durable paper (cardboard templates tend to lose the measurement accuracy required once folded). A measurement must be supplied with template to ensure accuracy of finished product.

EYEBROWS / ARCHES

SHOWN: GS419 IN AMERICAN CHERRY

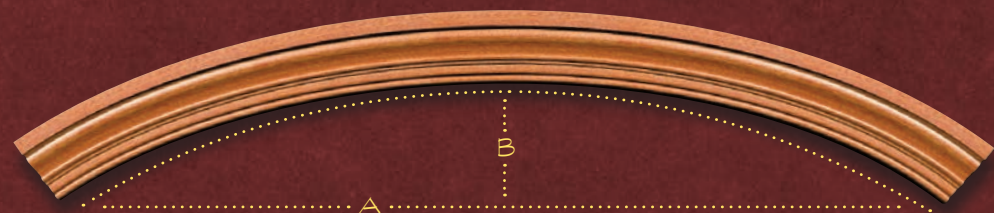

Measurements Required:

- \triangle Measurement - Unit Width/Inside Jamb to Jamb
- \square Measurement - Chord Height to Inside of Jamb

HALF ROUNDS

SHOWN: PL458 PRIMED MDF

Measurements Required:

- \triangle Measurement Only - Inside Jamb To Jamb

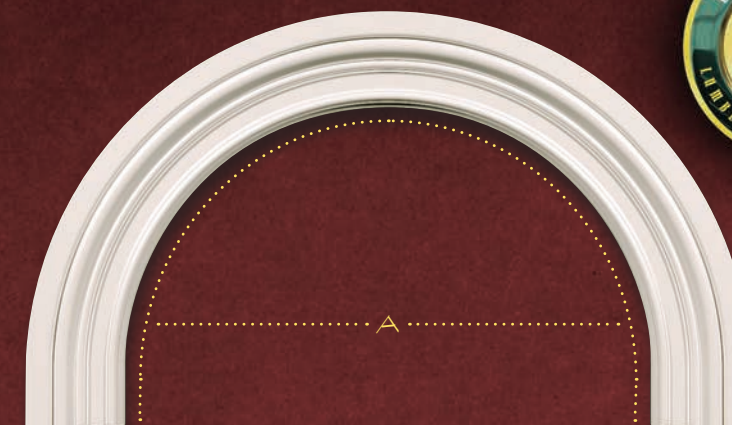

OVALS

SHOWN: ES1 IN PVC

Measurements Required:

- \triangle Measurement - Unit Width Inside Jamb to Jamb
- \square Measurement - Unit Height Inside Jamb to Jamb

* All our milled PVC Arches will have a factory applied bonding primer to obtain a smooth finished product

TEMPLATE REQUIRED

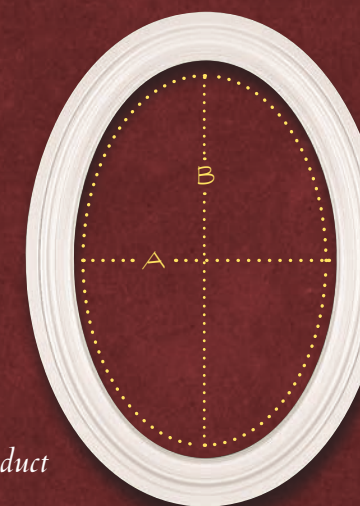

Oval units require a template of the jamb supplied on Red Rosin paper, Tyvek, or any flat surface durable paper (cardboard templates tend to lose the measurement accuracy required once folded). A and B measurements must be supplied with template to ensure accuracy of finished product.

FULL ROUNDS

SHOWN: 5/4 X 4 (1" X 3-1/2") PVC

Measurements Required:

- \triangle Measurement Only - Unit Width/Inside Jamb to Jamb (diameter)

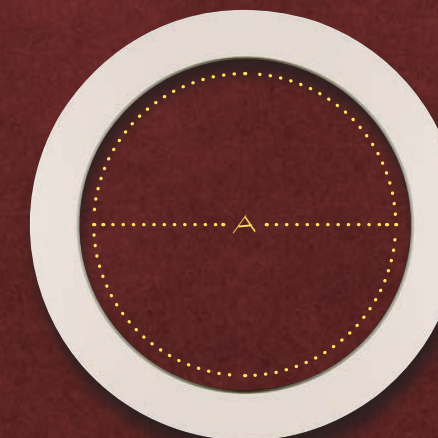

Introducing BEADED PANEL

& STRIP PRODUCTS

nantucket®
beadboard

Introducing our newest line of beaded panels and strip products. We have now expanded our line of primed MDF beadboard to include all of Nantucket Beadboard's product offerings and manufacturing capabilities.

- Broadened mix of on ground inventory
- Quick ship program for all non stock products
- Custom profile & pattern availability
- No minimum quantities

Stock items = 1-3 day lead time
Quick Ship items = 3 week lead time
Special Order items = 4 week lead time



GARDEN STATE LUMBER STOCK

IN STOCK FOR IMMEDIATE SHIPMENT

Standard Bead – 2" & 3" On Center

Profile Shown at 45%

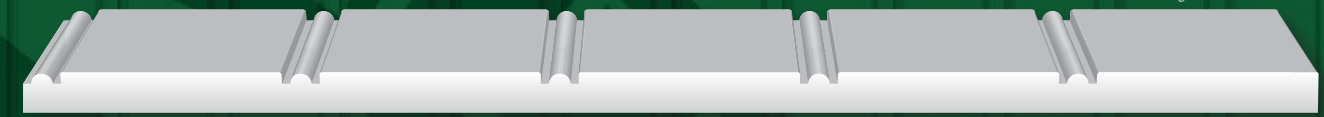

THICKNESS	MDF			MRI/NAF*	PVC
	8'	10'	12'	8'	8'
1/4"	14-SB2SB 14-SB3SB				
1/2"	SB2SB SB3SB	SB2SB-10 SB3SB-10	SB2SB-12 SB3SB-12	SB2SB-MRI SB3SB-MRI	SB2SB-PVC SB3SB-PVC

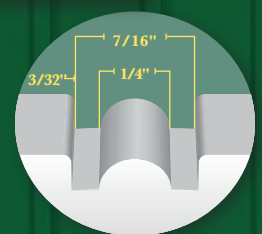

V-Bead – 1-5/8" & 2-1/2" On Center

Profile Shown at 45%



THICKNESS	MDF			MRI/NAF*	PVC
	8'	10'	12'	8'	8'
1/4"	14-SB158VB 14-SB212VB				
1/2"	SB158VB SB212VB	SB158VB-10 SB212VB-10	SB158VB-12 SB212VB-12	SB158VB-MRI SB212VB-MRI	SB158VB-PVC SB212VB-PVC

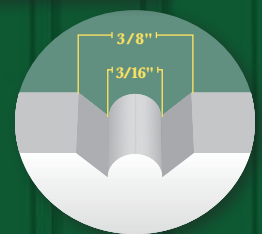

Modern Groove (1/4x1/4) – 6" On Center

Profile Shown at 45%

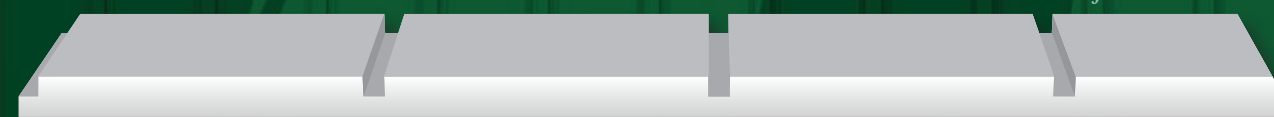

THICKNESS	MDF			MRI/NAF*	PVC
	8'	10'	12'	8'	8'
1/2"	SB6MG	SB6MG-10	SB6MG-12		

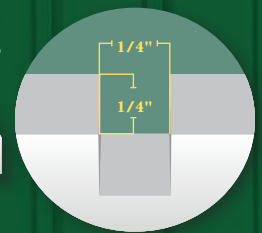

V-Groove – 6" On Center

Profile Shown at 45%

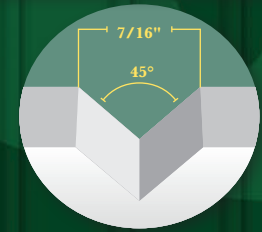
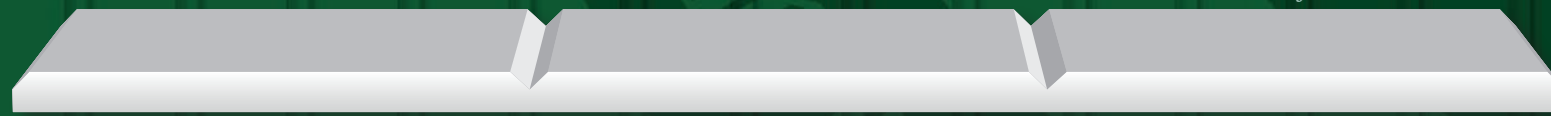

THICKNESS	MDF			MRI/NAF*	PVC
	8'	10'	12'	8'	8'
1/2"	SB6VG	SB6VG-10	SB6VG-12	SB6VG-MRI	SB6VG-PVC

Modern Groove (1/8x1/4) – 6" & 8" On Center

Nickel Gap

Profile Shown at 45%

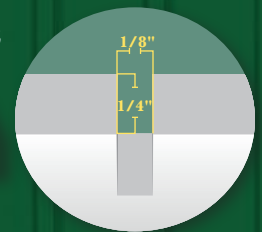

THICKNESS	MDF			MRI/NAF*	PVC
	8'	10'	12'	8'	8'
1/2"	SB6NK SB8NK	SB6NK-10 SB8NK-10	SB6NK-12 SB8NK-12		

* MRI/NAF = MOISTURE RESISTANT & NO ADDED FORMALDEHYDE - PRIMED ON BOTH SIDES

* MRI/NAF = MOISTURE RESISTANT & NO ADDED FORMALDEHYDE - PRIMED ON BOTH SIDES

QUICK SHIP+ SHEET PRODUCTS

3 WEEK LEAD TIME

Our Quick Ship+ products offer a variety of styles you won't find elsewhere.

- Short Lead Time Of 3 Weeks
- No Minimum Quantities



3" Standard Bead, MRI/NAF, BBCAP12, GSB725



2-1/2" V-Bead Fire Rated MDF, BS134, D8121, GSB534



8" On Center V-Groove, LK4 Casing, FS312 Stool, LK3 apron



2" On Center Standard Bead, PLC634 Crown, Cap Combination: 1x4, SC214, FS312



2-1/2" On Center V-Bead, GSC512, 8577 (Coffered Ceiling), LK4 Casing

QUICK SHIP+ SHEET PRODUCTS

3 WEEK LEAD TIME



Standard Bead Quick Ship Items

AVAILABLE 2" AND 3" ON CENTER

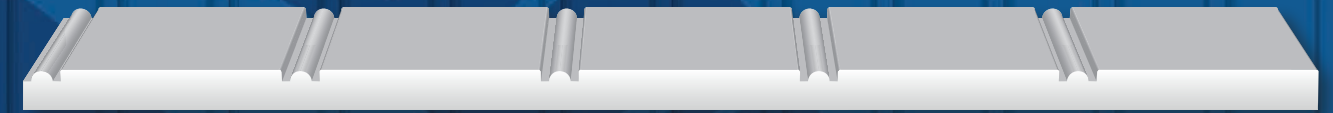

Profile Shown at 45%

THICKNESS	MDF	MRI/NAF	MRX	FR MDF	PVC
3/8"	8' 10' 12'				
1/2"	16'	10' 16'	8'	8'	8'

**All sheet goods are available in 4' wide the above chart depicts the available lengths*

MRI = MOISTURE RESISTANT / NO ADDED FORMALDEHYDE ■ MRX = EXTERIOR MDF ■ FR= FIRE RATED (CLASS A)

V-Bead Quick Ship Items

AVAILABLE 1-5/8" AND 2-1/2" ON CENTER



Profile Shown at 45%

THICKNESS	MDF	MRI/NAF	MRX	FR MDF	PVC
3/8"	8' 10' 12'				
1/2"	16'	10' 16'	8'	8'	8'

**All sheet goods are available in 4' wide the above chart depicts the available lengths*

MRI = MOISTURE RESISTANT / NO ADDED FORMALDEHYDE ■ MRX = EXTERIOR MDF ■ FR= FIRE RATED (CLASS A)

V-Groove Quick Ship Items

AVAILABLE 4", 6" & 8" ON CENTER

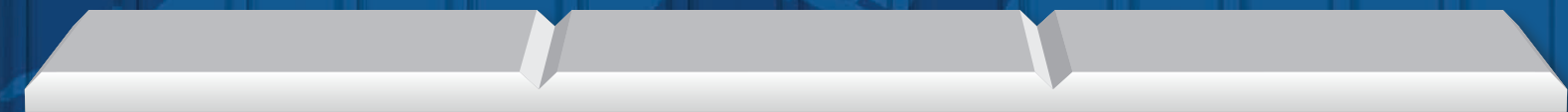

Profile Shown at 45%

THICKNESS	MDF	MRI/NAF	MRX	FR MDF	PVC
1/2"	8' 10' 12' 16'	8' 10' 16'	8'	8'	8'

**All sheet goods are available in 4' wide the above chart depicts the available lengths*

MRI = MOISTURE RESISTANT / NO ADDED FORMALDEHYDE ■ MRX = EXTERIOR MDF ■ FR = FIRE RATED (CLASS A)

QUICK SHIP+ SHEET PRODUCTS

3 WEEK LEAD TIME

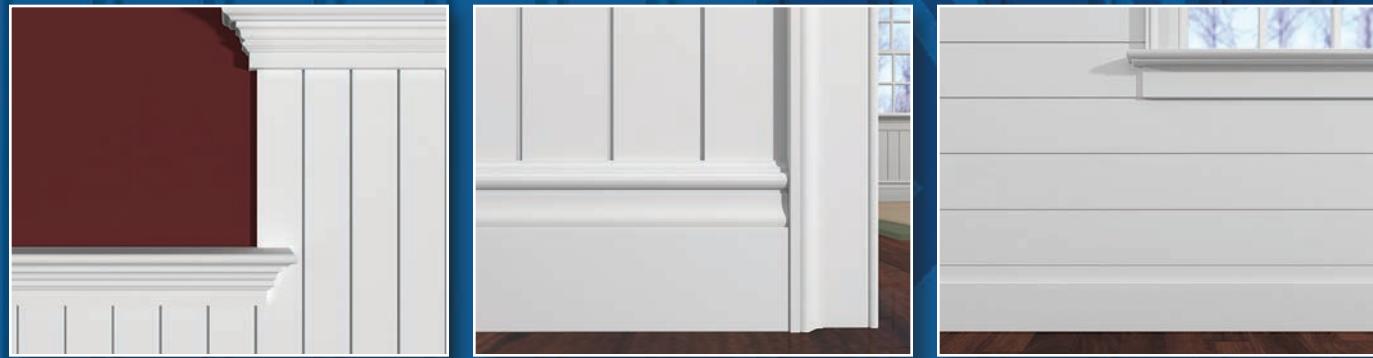

1/8" x 1/4" Modern Groove (4" On Center),
Cap Combination: 1x4, SC214, FS312

1/4" x 1/4" Modern Groove (4" On Center),
GSB725 Base, LK4 Casing

1/4" x 1/8" Modern Groove (6" On Center),
FS312 Stool, LWM432 Apron, SAN525 Base

Modern Grooves

Available in 4", 6" & 8" On Center

Profile Shown at 45%

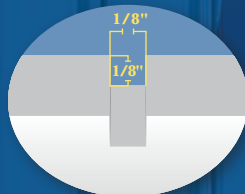
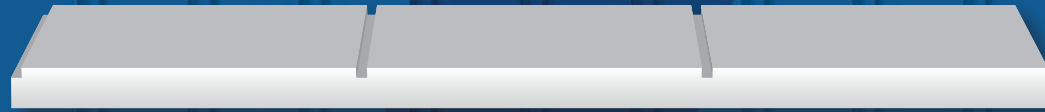

1/8" x 1/8" Modern Groove

Profile Shown at 45%

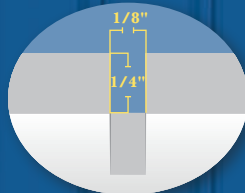

1/8" x 1/4" Modern Groove

Profile Shown at 45%

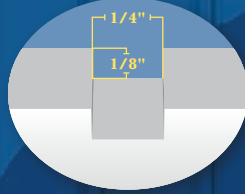

1/4" x 1/8" Modern Groove

Profile Shown at 45%

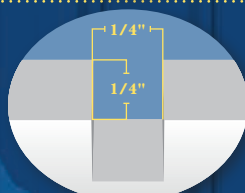

1/4" x 1/4" Modern Groove

THICKNESS	MDF	MRI/NAF	MRX	FR MDF	PVC
1/4"	8' **				
3/8"	8' 10' 12' **				
1/2"	8' 10' 12' 16'	8' 10' 16'	8'	8'	8'

*All sheet goods are available in 4' wide the above chart depicts the available lengths

** Only Available In 1/4" x 1/8" & 1/8" x 1/8"

MRI = MOISTURE RESISTANT / NO ADDED FORMALDEHYDE ■ MRX = EXTERIOR MDF ■ FR= FIRE RATED (CLASS A)

QUICK SHIP+ SHEET PRODUCTS

3 WEEK LEAD TIME



Random VG-1 & Random VG-2

Shown 48" wide at 15%



Random VG-1

Shown 48" wide at 15%



Random VG-2

Most patterns depicted in this catalogue can be special ordered to the Random 1 and Random 2 configurations.

Random 1: 3 1/2", 5 1/2", 5 1/2", 7 1/2", 5 1/2", 3 1/2", 7 1/2", 4 1/2", 5 = 48"

Random 2: 4", 6", 8", 4", 6", 8", 4", 8" = 48"

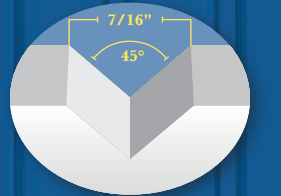

THICKNESS	MDF	MRI/NAF	MRX	FR MDF	PVC
1/2"	8' 10' 12' 16'	8' 10' 16'	8'	8'	8'

*All sheet goods are available in 4' wide the above chart depicts the available lengths

Mini V-Groove & Mini Mini V-Groove

Available in 4", 6" & 8" On Center

Profile Shown at 45%

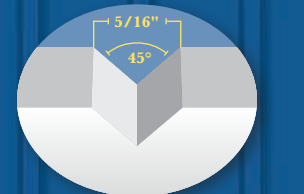

Mini V-Groove

Profile Shown at 45%

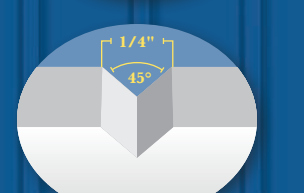

Mini Mini V-Groove

THICKNESS	MDF	MRI/NAF	MRX	FR MDF	PVC
1/4"	8' (Mini Mini V-Groove Only)				
3/8"	8' 10' 12'				
1/2"	8' 10' 12' 16'	8' 10' 16'	8'	8'	8'

*All sheet goods are available in 4' wide the above chart depicts the available lengths

MRI = MOISTURE RESISTANT / NO ADDED FORMALDEHYDE ■ MRX = EXTERIOR MDF ■ FR= FIRE RATED (CLASS A)

SHIPLAP STRIP PRODUCTS

3 WEEK LEAD TIME

Outstanding for Ceiling Applications

Another elegant solution we offer from Nantucket BeadBoard is their shiplap strip products. These easy to install strips dramatically increase your building options by giving you another dimension in beadboard.

- Ideal For Ceiling Applications
- Dramatically Decreases Your Install Time
- Easy To Handle
- Short Lead Time Of 3 Weeks

Standard Bead

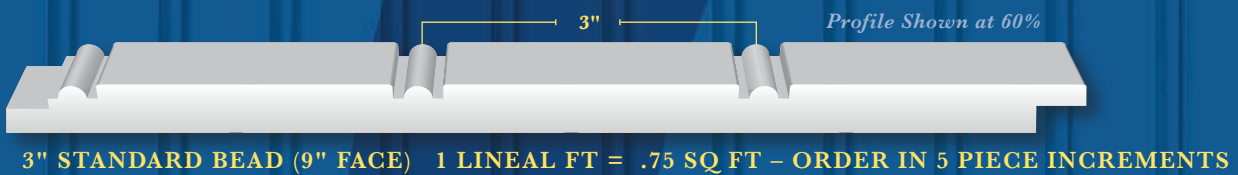
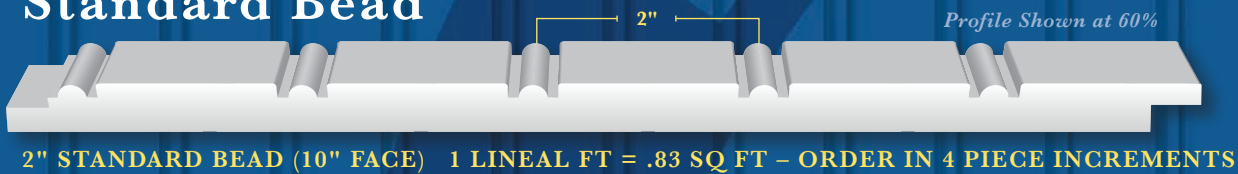

V-Bead

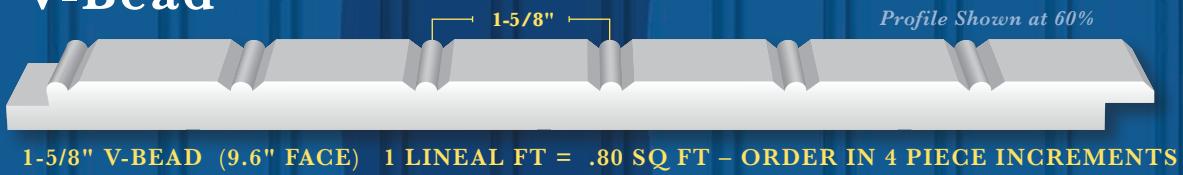

V-Groove

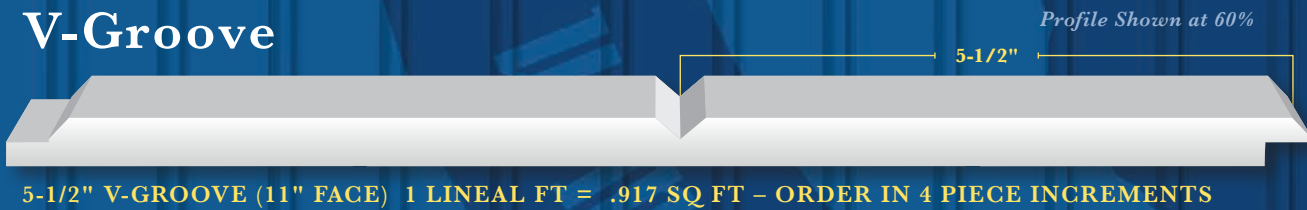

All Shiplap Products are Quick Ship

THICKNESS	MDF	MRI/NAF	MRX	FR MDF
1/2"	8' 10' 12' 16'	8' 10' 16'	8'	8'

MRI = MOISTURE RESISTANT / NO ADDED FORMALDEHYDE ■ MRX = EXTERIOR MDF ■ FR= FIRE RATED (CLASS A)

SHIPLAP STRIP PRODUCTS

3 WEEK LEAD TIME



Modern Shiplap Strip



Specify your desired fit:

- Flush Fit
- 1/8" Groove
- 1/4" Groove

See details below

Flush Fit Detail

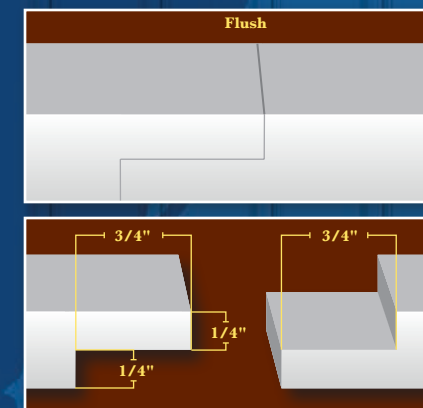

1/8" Groove Detail

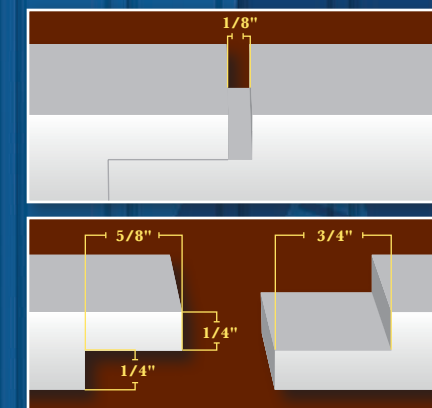

1/4" Groove Detail

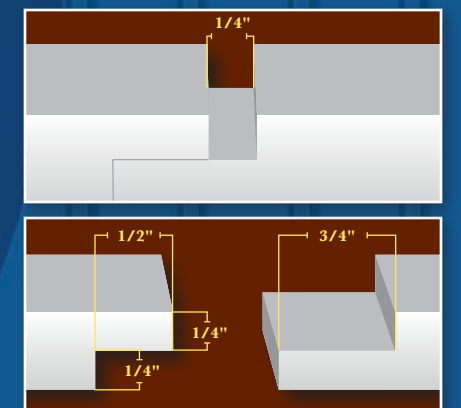

All Shiplap Products are Quick Ship

THICKNESS	MDF	MRI/NAF	MRX	FR MDF
1/2"	12' 16'	8' 10' 16'	8'	8'

MRI = MOISTURE RESISTANT / NO ADDED FORMALDEHYDE ■ MRX = EXTERIOR MDF ■ FR= FIRE RATED (CLASS A)

SPECIAL ORDER SHEET PRODUCTS

4 WEEK LEAD TIME

Manufactured To Your Specified Distance On Center

If you are looking for something both unique and highly customizable, our special order products offer a wide variety of options.

- Unique Selection Of Styles
- Manufactured To Your Desired Distance On Center
- Beads Run In Either 4' Or 8' Direction
- No Minimum Quantities
- Short Lead Times Of 4 Weeks



V-Channel (4" On Center),
Cap Combination: 1x4, SC214, FS312



Butterfly (4" On Center), FS312 Stool,
LK3 Apron, GSB725



Jumbo V-Bead (3" On Center),
GSB725 Base, LK4 Casing



Standard Bead
(Modified to 6" On Center),

SPECIAL ORDER SHEET PRODUCTS

4 WEEK LEAD TIME

Manufactured To Your Specified Distance On Center



Cove Bead (3-1/2" On Center),
Cap Combination: 1x4, SC214, FS312



V-Channel (2-1/2" On Center),
GSB725 Base, LK4 Casing



Large Butterfly (5" On Center),
Cap Combination: 1x4, SC214, FS312

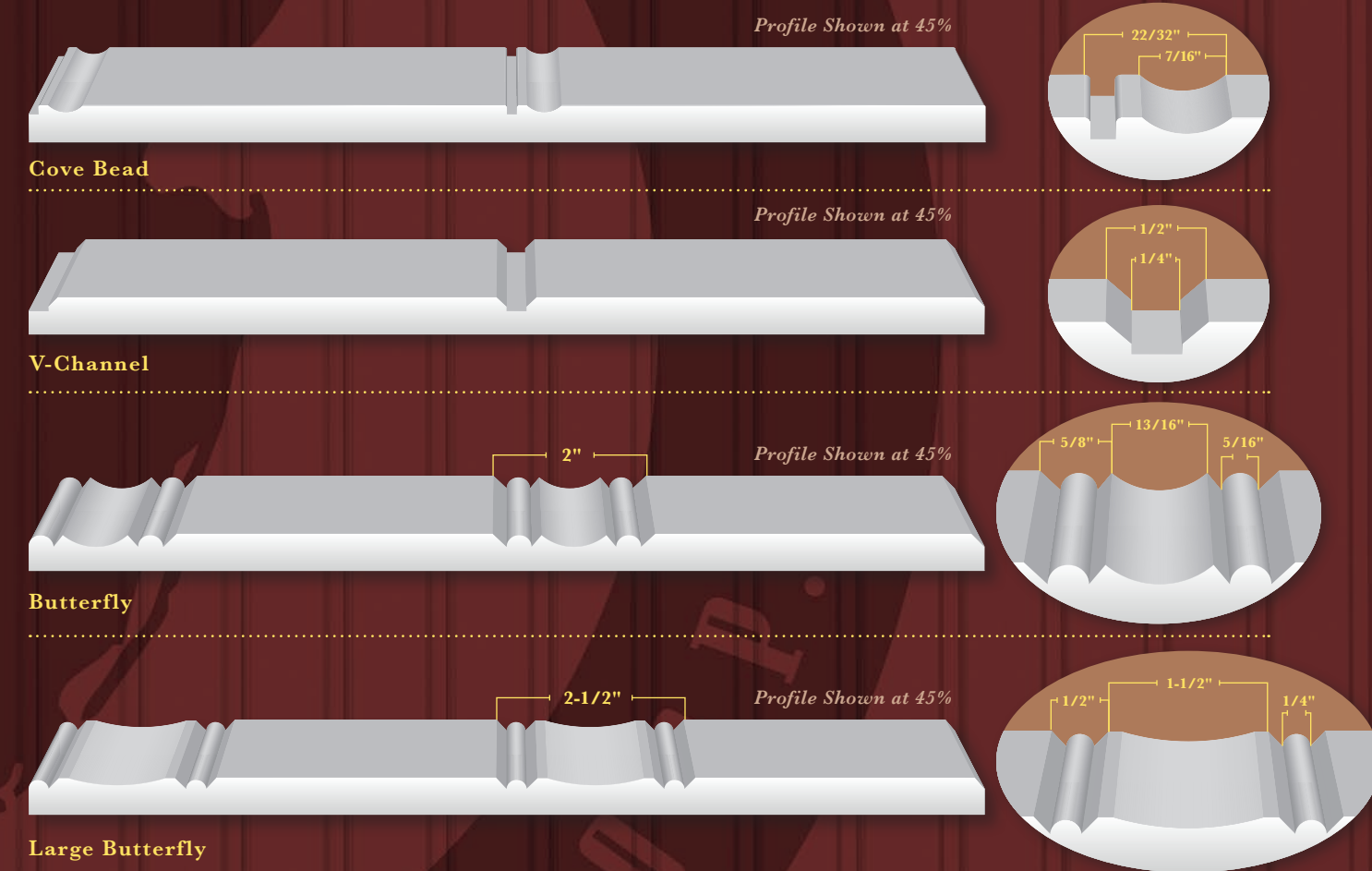

THICKNESS	MDF	MRI/NAF	MRX	FR MDF	PVC
1/2"	8' 10' 12'	8' 10'	8'	8'	8'

*All sheet goods are available in 4' wide the above chart depicts the available lengths
MRI = MOISTURE RESISTANT / NO ADDED FORMALDEHYDE ■ MRX = EXTERIOR MDF ■ FR= FIRE RATED (CLASS A)

SPECIAL ORDER SHEET PRODUCTS

4 WEEK LEAD TIME

Manufactured To Your Specified Distance On Center



Jumbo V-Bead (3" On Center),
Cap Combination: 1x4, SC214, FS312



Large V-Bead (3" On Center),
Cap Combination: 1x4, SC214, FS312



Large Standard Bead (3" On Center),
Cap Combination: 1x4, SC214, FS312

Large Special Order Beads

Profile Shown at 45%



Large V-Bead

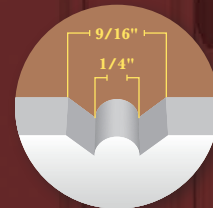

Profile Shown at 45%



Jumbo V-Bead

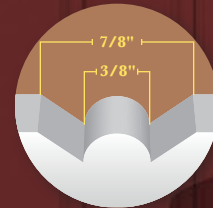

Profile Shown at 45%



Large Standard Bead

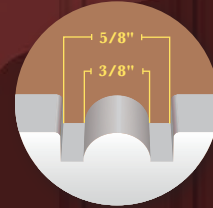

Profile Shown at 45%



Jumbo Standard Bead

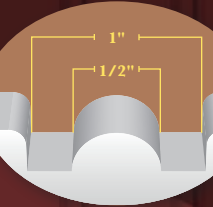

THICKNESS	MDF	MRI/NAF	MRX	FR MDF	PVC
1/2"	8' 10' 12'	8' 10'	8'	8'	8'

*All sheet goods are available in 4' wide the above chart depicts the available lengths

MRI = MOISTURE RESISTANT / NO ADDED FORMALDEHYDE ■ MRX = EXTERIOR MDF ■ FR= FIRE RATED (CLASS A)



Introducing
NuCedar Mills[®]
finely crafted exteriors

NuCedar Mills' complete exterior cladding system is finely milled from NuCedar Trim cellular PVC and is purposefully engineered to maintain faithful profiles, dimensional accuracy, durability, and ease of installation unrivaled in the industry.



NuCedar PVC Trimboards

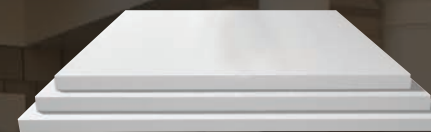

NuCedar PVC Sheet Stock



NuCedar PVC Mouldings



Prefinished Color PVC Trim 

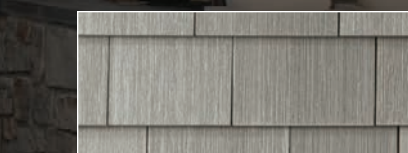

NuCedar Shingles & Siding

Now Available at





IN-STOCK

PVC TRIMBOARDS

SMOOTH/SMOOTH

WOOD GRAIN/SMOOTH



WHITE PVC TRIMBOARDS (AVAILABLE IN SMOOTH AND WOOD GRAIN)			
SKU	NOMINAL SIZE	ACTUAL SIZE	LENGTH
D14PVC and D14PVCW	1" x 4"	3/4" x 3-1/2"	18'
D16PVC and D16PVCW	1" x 6"	3/4" x 5-1/2"	18'
D18PVC and D18PVCW	1" x 8"	3/4" x 7-1/4"	18'
D110PVC and D110PVCW	1" x 10"	3/4" x 9-1/4"	18'
D112PVC and D112PVCW	1" x 12"	3/4" x 11-1/4"	18'
D544PVC and D544PVCW	5/4" x 4"	1" x 3-1/2"	18'
D546PVC and D546PVCW	5/4" x 6"	1" x 5-1/2"	18'
D548PVC and D548PVCW	5/4" x 8"	1" x 7-1/4"	18'
D5410PVC and D5410PVCW	5/4" x 10"	1" x 9-1/4"	18'
D5412PVC and D5412PVCW	5/4" x 12"	1" x 11-1/4"	18'
STARPVC	375 plugs & screws	250 LF of coverage	Box
FILLNFX	Fill and Flex Adhesive		10 oz. tubes
ERASER	PVC Nail Eraser		"crayon"

*W = WOOD GRAIN (WOODGRAIN ONE SIDE, SMOOTH ONE SIDE)

WHITE PVC EDGE & CENTER BEAD			
SKU	NOMINAL SIZE	ACTUAL SIZE	LENGTH
ECB55PVC	1/2" x 6"	1/2" x 5-1/2"	16'

WHITE PVC CORNER BOARDS			
SKU	NOMINAL SIZE	ACTUAL SIZE	LENGTH
CB544PVC	5/4" x 4"	1" x 3-1/2"	20'
CB546PVC	5/4" x 6"	1" x 5-1/2"	20'



IN-STOCK

PVC SHEET STOCK

WHITE PVC SHEET STOCK						
THICKNESS	WIDTH	LENGTH				TEXTURE
		8'	10'	12'	18'	
1/4"	4'	●				SMOOTH
3/8"	4'	●	●			SMOOTH
1/2"	4'	●	●	●	●	SMOOTH
5/8"	4'	●				SMOOTH
3/4"	4'	●	●	●	●	SMOOTH
1"	4'	●	●	●	●	SMOOTH



WHITE PVC BEADBOARD SHEETS BY NANTUCKET BEADBOARD			
SKU	SIZE	DISTANCE ON CENTER	BEAD TYPE
SB158VB-PVC	1/2" X 4' X 8'	1-5/8"	V-BEAD
SB212VB-PVC	1/2" X 4' X 8'	2-1/2"	V-BEAD
SB2SB-PVC	1/2" X 4' X 8'	2"	STANDARD BEAD
SB3SB-PVC	1/2" X 4' X 8'	3"	STANDARD BEAD
SB6VG-PVC	1/2" X 4' X 8'	6"	V-GROOVE

PREFINISH IT

GET YOUR PVC PAINTED

Garden State Lumber now offers PVC mouldings, trim boards and sheet goods prefinished in any PPG Paints color of your choosing. Avoid the hassle and time of painting on-site and get a consistent, high quality manufacturer finish with a 25 year warranty.



GARDEN STATE LUMBER COLOR RECOMMENDATIONS:

The following color recommendations have been carefully selected to match the most common siding and window manufacturer color palettes available in the market.



We can pre-finish to any PPG Paints color of your choosing using the PPG color code. See page 154 and 155 for full color details.



WHITE PVC MOULDINGS

IN-STOCK

Please note that mouldings are shown at 60% of their actual size.

WHITE PVC MOULDINGS

IN-STOCK

CROWNS



UC51PVC
11/16 x 5-5/8

L8027PVC
9/16 x 5-1/4

WM47PVC
11/16 x 4-5/8

LWM49PVC
9/16 x 3-5/8

WM53PVC
9/16 x 2-5/8

BC5PVC
1-1/16 x 5-1/4

UC41PVC
11/16 x 4-5/8

RAKE/SOLID CROWNS



SC234PVC
1-3/8 x 2-3/4

RAMPVC
1-13/32 x 2
(Rams Crown)

RAKEPVC
1 x 2

WM210PVC
11/16 x 1-5/8

COVE/BED MOULDINGS



8016PVC
9/16 x 1-5/8

WM93PVC
3/4 x 3/4

NOSE & COVES



8578PVC
11/16 x 1-1/8

8577PVC
5/8 x 3/4

BASE CAPS



8416PVC
5/8 x 1-5/8

WM164PVC
11/16 x 1-1/8

QUARTER ROUND



8065PVC
3/4 x 3/4

PANELS



Rabbeted
Panel

ES11PVC
1-1/8 x 1-3/4

PL2PVC
3/4 x 2

PL134PVC
9/16 x 1-3/4

PREFINISH IT

GET YOUR PVC PAINTED

Garden State Lumber now offers PVC mouldings, trim boards and sheet goods prefinished in any PPG Paints color of your choosing. Avoid the hassle and time of painting on-site and get a consistent, high quality manufacturer finish with a 25 year warranty.



GARDEN STATE LUMBER COLOR RECOMMENDATIONS:

The following color recommendations have been carefully selected to match the most common siding and window manufacturer color palettes available in the market.



We can pre-finish to any PPG Paints color of your choosing using the PPG color code. See page 154 and 155 for full color details.



WHITE PVC MOULDINGS

IN-STOCK

Please note that mouldings are shown at 60% of their actual size.

WHITE PVC MOULDINGS

IN-STOCK

EDGE & CENTER BEAD CAP



ECBCAPPVC
1-3/8 x 1-3/4

BRICK MOULD



WM180PVC
1-1/4 x 2

CASING / CASING COMBINATIONS



BDB35PVC
with
138BBPVC

CORNER BOARDS



CB544PVC
1 x 3-1/2
CB546PVC
1 x 5-1/2

*Also available with 3/4" J-Channel

EDGE & CENTER BEADS



BP512PVC
3/8 x 5-1/2 (Beaded Planking)

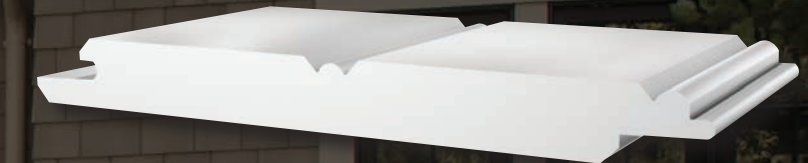

ECB55PVC
1 x 6 Edge & Center Bead (1/2 x 5-1/2)

BASES



BB514PVC
9/16 x 5-1/4



BDB35PVC
3/4 x 3-1/2

BACKBAND



138BBPVC
1-3/8 x 1-3/8

CASING



WC1CTPVC
1-1/16 x 3-1/2



BDB35PVC
with
ECBCAPPVC



WC1CTPVC
1-1/16 x 3-1/2

SILL/SILL NOSING



SILL7118
1-5/16 x 1-3/8



SILL7117PVC
1-1/4 x 5-1/4



SILL7435PVC
1-3/4 x 2-3/4



SILL7650 (Historic Sill)
1-3/4 x 2

DRIP CAP



WM197PVC
11/16 x 1-5/8

PREFINISH IT

GET YOUR PVC PAINTED

Garden State Lumber now offers PVC mouldings, trim boards and sheet goods prefinished in any PPG Paints color of your choosing. Avoid the hassle and time of painting on-site and get a consistent, high quality manufacturer finish with a 25 year warranty.



GARDEN STATE LUMBER COLOR RECOMMENDATIONS:

The following color recommendations have been carefully selected to match the most common siding and window manufacturer color palettes available in the market.



We can pre-finish to any PPG Paints color of your choosing using the PPG color code. See page 154 and 155 for full color details.



PRE-FINISHED COLOR PVC TRIM BOARDS, SHEET STOCK, MOULDINGS AND BEADED PANEL PROGRAM



SMOOTH

WOOD GRAIN

ROUGH SAWN

- Choose your **PVC TRIM BOARD** size and texture (available in smooth, woodgrain, or rough sawn, 16' or 18')
- Choose your **PVC SHEET STOCK** size and texture (smooth and wood grain only)
- Select your **PVC BEADED SHEETS**
- Select your **PVC MOULDINGS**
- Choose from any of our color recommendations (3-4 week lead time) or select any PPG Paints color of your choosing (4-5 week lead time)
- Add **STARBORN PRO PLUGS SYSTEM** (boxes are 250 lineal foot of coverage = 375 plugs / 375 screws) * prefinished to your color selection
- Add some **TOUCH UP PAINT**



GARDEN STATE LUMBER COLOR RECOMMENDATIONS

The following color recommendations have been carefully selected to match the most common siding and window manufacturer color palettes available in the market.

(4 week lead time)



OR GET CUSTOM COLORS

We can pre-finish to any PPG Paints color of your choosing using the PPG color code. (4-5 week lead time)

* All pre-finished color PVC products finished on 3 sides, face and 2 edges

* Garden State Lumber recommends ordering an additional cushion of 5-10% of material to make sure jobs needs are covered

PREFINISH IT

GET YOUR PVC PAINTED

Garden State Lumber now offers PVC mouldings, trim boards and sheet goods prefinished in any PPG Paints color of your choosing. Avoid the hassle and time of painting on-site and get a consistent, high quality manufacturer finish with a 25 year warranty.



- The durability of NuCedar Trim color is achieved through a unique surface technology developed in conjunction with PPG Paints.
- NuCedar Trim's unique finish protects the PVC core against UV exposure, so that it never warps or twists in the sun.
- The water-based, solar-reflective coating is extremely durable and will not peel, crack or chip.
- NuCedar Trim carries a 25-year warranty on both the material and the finish.





NuCedar Mills®

finely crafted exteriors

NuCedar Shingles

13" & 18" ROUGHSAWN SHINGLES

AVAILABLE IN 14 STANDARD COLORS OR
CUSTOM PPG PAINT COLORS

ALL STANDARD COLORS IN STOCK FOR IMMEDIATE SHIPMENT

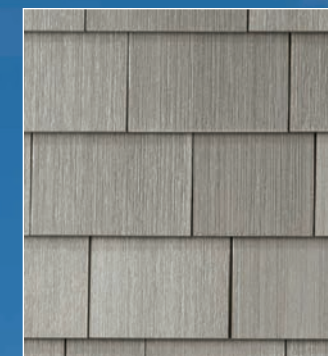

NuCedar Vertical Siding

CHANNEL RUSTIC | SHIPLAP | BOARD & BATTEN

SMOOTH & ROUGHSAWN

AVAILABLE IN 14 STANDARD COLORS (4 WEEKS) OR
CUSTOM PPG PAINT COLORS (5 WEEKS)



NuCedar Modern Shiplap

4", 6", 8", 10" EXPOSURE SHIPLAP

AVAILABLE IN SMOOTH & ROUGHSAWN

AVAILABLE IN 14 STANDARD COLORS (4 WEEKS) OR
CUSTOM PPG PAINT COLORS (5 WEEKS)





NuCedar Shingles in RoughSawn™—Argos



Available in 14 standard colors or custom PPG Paint colors

SUPER WHITE (NC-01)	WOOL SKEIN (NC-02)	BASKET BEIGE (NC-03)	ARGOS (NC-04)	ANTIQUE WHITE (NC-05)	WORLDLY GRAY (NC-06)	INTELLECTUAL GRAY (NC-07)
CEDAR (NC-08)	SVELTE SAGE (NC-09)	QUIVER TAN (NC-10)	ALEUTIAN BLUE (NC-11)	COASTAL PLAIN (NC-12)	BRACING BLUE (NC-13)	NEW! WHOLE WHEAT (NC-14)



NuCedar Mills
finely crafted exteriors

NuCedar Shingles

ALL COLORS IN STOCK FOR IMMEDIATE SHIPMENT

NuCedar Shingles accurately capture the natural beauty and charm of precisely tapered, resquared, and rebuted cedar shingles. With no two shingles produced exactly the same, craftsmen are able to create the quilt-like patterns once only possible with natural cedar. Available in 14 traditional colors.



SKU	Shingles	Exposure	Thickness	Width	Box Qty	Colors
NCS13	13"	up to 5"	1/2"	4", 5", 6", 7", 8"	1/4 Square	All in stock
NCS18	18"	5-1/2"-7"	1/2"	5", 6", 7", 8", 9"	1/4 Square	All in stock

*1 box = 1/4 square (4 box per square) based on 5" exposure for 13" shingle and 7" exposure for 18" shingle.
1 Square = 100 Sq Ft of coverage

ACCESSORIES



4oz Dauber of Paint
Touchup Paint
1 included with every 20 boxes (5 square)
SKU: PAINT-D



Matching Pint, Quart or Gallon of Paint
Pint: PAINT-P
Quart: PAINT-Q
Gallon: PAINT-G



Fill & Flex Adhesive for Shingles/Trim
300 ML (10 Oz. Tube)
SKU: FILLNFLX*
*For use in first four courses and areas of high heat concentration

INSTALLATION

NuCedar RoughSawn Shingles™ are Manufactured from PVC making them resistant to the effects of salt air, weathering, and infestation. Our shingles outperform cedar in durability and color retention, and carry a **25-year transferable warranty**.



Installs just like traditional cedar shingles. Use exterior grade ring shank (5D Stainless) or siding nails or at least 7/16" wide crown stainless steel staples.



Utilizes Standard Trim and Corners.



Alternate shingle courses on corners to create a "Boston Weave."

Timeless Beauty

SEE GARDENSTATELUMBER.COM OR NUCEDAR.COM FOR FULL INSTALLATION INSTRUCTIONS



NuCedar Board & Batten — Cedar

All Vertical Siding Available In



RoughSawn™



Smooth

25 YEAR WARRANTY

NuCedar Vertical Siding is impervious to infestation and water, allowing it to run to grade without worry of rotting, decay, or other moisture-related concerns. Factory finished with a water-based coating from PPG Paints™ and backed by a 25-year transferable warranty, NuCedar Vertical Siding offers unmatched durability, low maintenance, and simple installation.

Available in 14 standard colors or custom PPG Paint colors

SUPER WHITE (NC-01)	WOOL SKEIN (NC-02)	BASKET BEIGE (NC-03)	ARGOS (NC-04)	ANTIQUE WHITE (NC-05)	WORLDLY GRAY (NC-06)	INTELLECTUAL GRAY (NC-07)
CEDAR (NC-08)	SVELTE SAGE (NC-09)	QUIVER TAN (NC-10)	ALEUTIAN BLUE (NC-11)	COASTAL PLAIN (NC-12)	BRACING BLUE (NC-13)	NEW! WHOLE WHEAT (NC-14)



NuCedar Mills®
finely crafted exteriors

NuCedar Vertical Siding

4 WEEKS (STANDARD COLOR) / 5 WEEKS (CUSTOM COLOR)

Whether used as an accent or as cladding on an entire home, NuCedar Mills' three vertical siding styles are designed to capture the historic character and rustic charm of architectural designs while offering an extended level of durability, low maintenance, and ease of installation. Available in 14 traditional color options.



Channel Rustic (Shown in Cedar Color NC-08)

SKU	Dimension	Face Width	Channel Width	Length	Approx Pc / Sq
RUSTIC6	5/8" x 5-1/2"	4"	1"	16'	15
RUSTIC8	5/8" x 7-1/4"	5-3/4"	1"	16'	12

4 oz of Touchup Paint supplied with every 6 Squares
* All Required Fasteners Are Included (Starborn Pro-plugs)

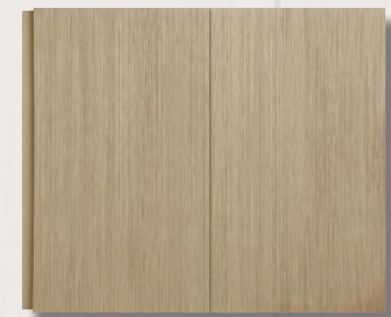

Tongue & Groove (Shown in Basket Beige Color NC-03)

SKU	Dimension	Face Width	Length	Approx Pc / Sq
TG6	5/8" x 5-1/2"	5"	16'	15
TG8	5/8" x 7-1/4"	6-3/4"	16'	12

4 oz of Touchup Paint supplied with every 6 Squares
* All Required Fasteners Are Included (Starborn Pro-plugs)



Board & Batten (Shown in Svelte Sage Color NC-09)

SKU	Dimension	Length	Approx Pc / Sq
BOARD	5/8" x 9-1/4"	16'	9
BATTEN	3/4" x 2"	16'	9

4 oz of Touchup Paint supplied with every 6 Squares
* All Required Fasteners Are Included (Starborn Pro-plugs)

ACCESSORIES

PRO PLUG® - 375 2" Screws & Plugs
SKU: STARPVC-P

Matching Pint, Quart or Gallon of Paint
4oz Dauber: PAINT-D
Pint SKU: PAINT-P
Quart SKU: PAINT-Q
Gallon SKU: PAINT-G

Fill & Flex Adhesive for Shingles/Trim
300 ML (10 Oz. Tube)
SKU: FILLNFLX



NuCedar Modern Shiplap in RoughSawn™—Intellectual Gray and Worldly Gray



NuCedar Modern Shiplap in RoughSawn™—Cedar

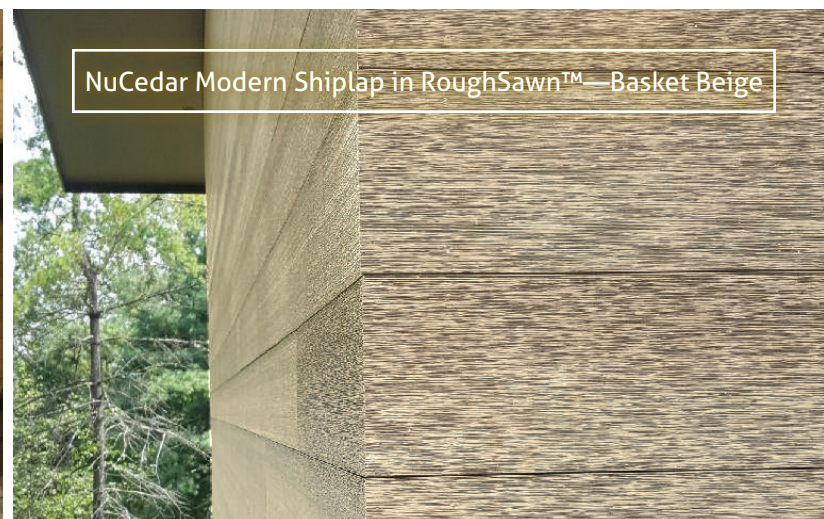

NuCedar Modern Shiplap in RoughSawn™—Basket Beige

Available in 14 standard colors or custom PPG Paint colors

SUPER WHITE (NC-01)	WOOL SKEIN (NC-02)	BASKET BEIGE (NC-03)	ARGOS (NC-04)	ANTIQUE WHITE (NC-05)	WORLDLY GRAY (NC-06)	INTELLECTUAL GRAY (NC-07)
CEDAR (NC-08)	SVELTE SAGE (NC-09)	QUIVER TAN (NC-10)	ALEUTIAN BLUE (NC-11)	COASTAL PLAIN (NC-12)	BRACING BLUE (NC-13)	NEW! WHOLE WHEAT (NC-14)



NuCedar Mills
finely crafted exteriors

NuCedar Modern Shiplap

4 WEEKS (STANDARD COLOR) / 5 WEEKS (CUSTOM COLOR)

NuCedar modern shiplap strips are the perfect marriage of rustic meets contemporary. With clean straight lines and multiple groove options, our shiplap products can be used in both a horizontal or vertical applications to achieve your desired aesthetic.

Flush	1/8" Groove	1/4" Groove	1/2" Groove	Dimensions	Face Width	Length	Approx Pc / Sq
MSHIP4F	MSHIP4E	MSHIP4Q	MSHIP4H	5/8" x 4-3/4"	4"	16'	19
MSHIP6F	MSHIP6E	MSHIP6Q	MSHIP6H	5/8" x 6-3/4"	6"	16'	13
MSHIP8F	MSHIP8E	MSHIP8Q	MSHIP8H	5/8" x 8-3/4"	8"	16'	10
MSHIP10F	MSHIP10E	MSHIP10Q	MSHIP10H	5/8" x 10-3/4"	10"	16'	8

4 oz of Touchup Paint supplied with every 6 Squares * All Required Fasteners Are Included (Starborn Pro-plugs)

GROOVE OPTIONS

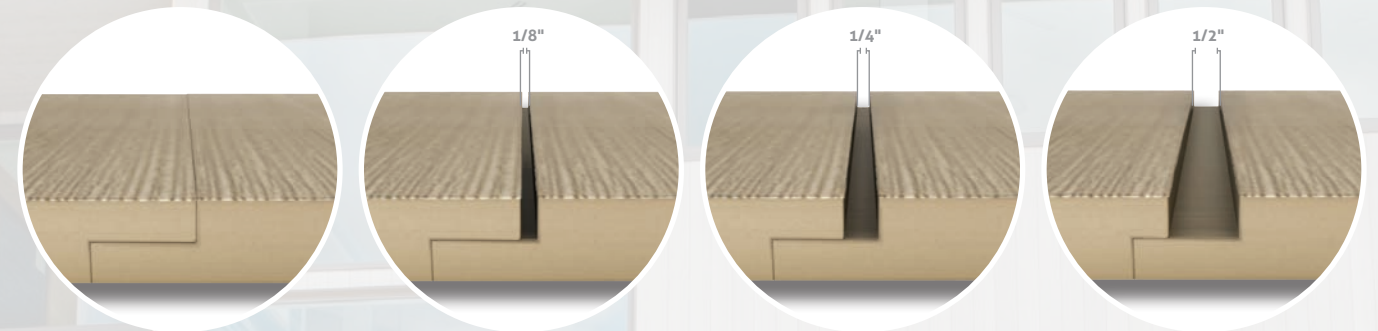

Flush

1/8" Groove

1/4" Groove

1/2" Groove



4" Shiplap

(Shown in Basket Beige Color NC-03, 1/4" Groove)



6" Shiplap

(Shown in Basket Beige Color NC-03, 1/4" Groove)



8" Shiplap

(Shown in Basket Beige Color NC-03, 1/4" Groove)



10" Shiplap

(Shown in Basket Beige Color NC-03, 1/4" Groove)

Timeless Beauty

SEE GARDENSTATELUMBER.COM OR NUCEDAR.COM FOR FULL INSTALLATION INSTRUCTIONS



Trim

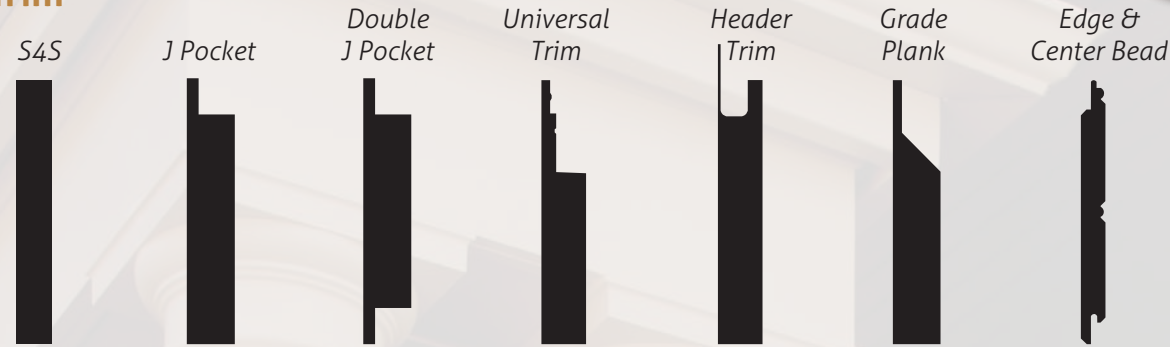

SKU	Nominal Size	Actual Size	Length	Available In
S4S TRIMBOARD				
D12PVC-P	1" x 2"	3/4" x 1-1/2"	16' & 18'	Smooth / Woodgrain / Roughsawn
D13PVC-P	1" x 3"	3/4" x 2-1/2"	16' & 18'	Smooth / Woodgrain / Roughsawn
D14PVC-P	1" x 4"	3/4" x 3-1/2"	16' & 18'	Smooth / Woodgrain / Roughsawn
D15PVC-P	1" x 5"	3/4" x 4-1/2"	16' & 18'	Smooth / Woodgrain / Roughsawn
D16PVC-P	1" x 6"	3/4" x 5-1/2"	16' & 18'	Smooth / Woodgrain / Roughsawn
D18PVC-P	1" x 8"	3/4" x 7-1/4"	16' & 18'	Smooth / Woodgrain / Roughsawn
D110PVC-P	1" x 10"	3/4" x 9-1/4"	16' & 18'	Smooth / Woodgrain / Roughsawn
D112PVC-P	1" x 12"	3/4" x 11-1/4"	16' & 18'	Smooth / Woodgrain / Roughsawn
D116PVC-P	1" x 16"	3/4" x 15-1/4"	16' & 18'	Smooth / Woodgrain / Roughsawn
D544PVC-P	5/4" x 4"	1" x 3-1/2"	16' & 18'	Smooth / Woodgrain / Roughsawn
D546PVC-P	5/4" x 6"	1" x 5-1/2"	16' & 18'	Smooth / Woodgrain / Roughsawn
D548PVC-P	5/4" x 8"	1" x 7-1/4"	16' & 18'	Smooth / Woodgrain / Roughsawn
D5410PVC-P	5/4" x 10"	1" x 9-1/4"	16' & 18'	Smooth / Woodgrain / Roughsawn
D5412PVC-P	5/4" x 12"	1" x 11-1/4"	16' & 18'	Smooth / Woodgrain / Roughsawn
J-POCKET TRIM - WITH 3/4" x 3/4" DADO				
JTRIM4	5/4" x 4"	1" x 4"	18'	Smooth / Woodgrain / Roughsawn
JTRIM6	5/4" x 6"	1" x 5-1/2"	18'	Smooth / Woodgrain / Roughsawn
JTRIM8	5/4" x 8"	1" x 7-1/4"	18'	Smooth / Woodgrain / Roughsawn
JTRIM10	5/4" x 10"	1" x 9-1/4"	18'	Smooth / Woodgrain / Roughsawn
JTRIM12	5/4" x 12"	1" x 11-1/4"	18'	Smooth / Woodgrain / Roughsawn
DOUBLE J-POCKET TRIM - WITH 3/4" x 3/4" DADO 2 SIDES				
DJTRIM4	5/4" x 4"	1" x 4"	18'	Smooth / Woodgrain / Roughsawn
DJTRIM6	5/4" x 6"	1" x 5-1/2"	18'	Smooth / Woodgrain / Roughsawn
DJTRIM8	5/4" x 8"	1" x 7-1/4"	18'	Smooth / Woodgrain / Roughsawn
DJTRIM10	5/4" x 10"	1" x 9-1/4"	18'	Smooth / Woodgrain / Roughsawn
DJTRIM12	5/4" x 12"	1" x 11-1/4"	18'	Smooth / Woodgrain / Roughsawn
GRADE PLANK				
PLANK16	1" x 6"	3/4" x 5-1/2"	18'	Smooth / Woodgrain / Roughsawn
PLANK18	1" x 8"	3/4" x 7-1/4"	18'	Smooth / Woodgrain / Roughsawn
PLANK110	1" x 10"	3/4" x 9-1/4"	18'	Smooth / Woodgrain / Roughsawn
PLANK546	5/4" x 6"	1" x 5-1/2"	18'	Smooth / Woodgrain / Roughsawn
PLANK548	5/4" x 8"	1" x 7-1/4"	18'	Smooth / Woodgrain / Roughsawn
PLANK5410	5/4" x 10"	1" x 9-1/4"	18'	Smooth / Woodgrain / Roughsawn
EDGE & CENTER BEAD				
ECB55PVC-P	1/2" x 6"	1/2" x 5-1/2"	16'	Smooth
34ECB55PVC-P	3/4" x 6"	3/4" x 5-1/2"	16'	Smooth



Corners

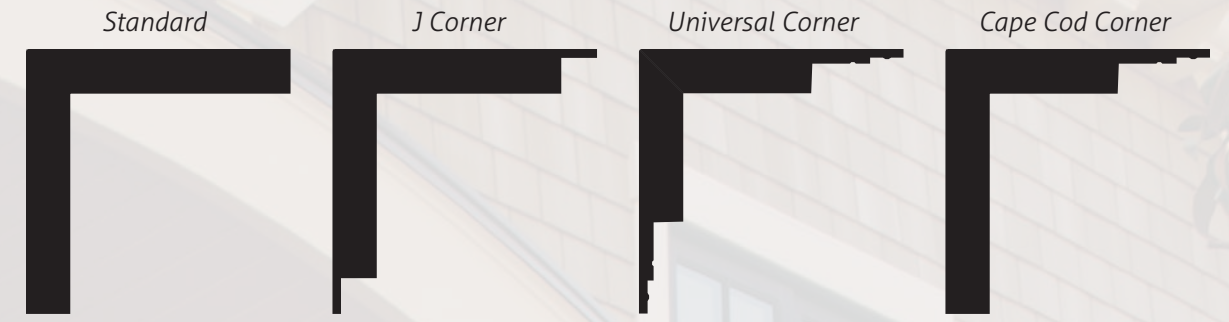

SKU	Corner	Nominal Size	Actual Size	Length	Available In
SCORNER4	Standard Corner	5/4" x 4"	1" x 3-1/2"	20'	Smooth / Woodgrain / Roughsawn
SCORNER6	Standard Corner	5/4" x 6"	1" x 5-1/2"	20'	Smooth / Woodgrain / Roughsawn
JCORNER	J Corner	5/4" x 6"	1" x 5-1/2"	20'	Smooth / Woodgrain / Roughsawn
UCORNER	Universal Corner	5/4" x 6"	1" x 5-1/2"	20'	Smooth / Woodgrain / Roughsawn
CCORNER	Cape Cod Corner	5/4" x 6"	1" x 5-1/2"	20'	Smooth / Woodgrain / Roughsawn

Mouldings

See pages 150-153 for details of PVC mouldings



NuCedar Colors

Available in 16 standard colors (2 trim only colors) or custom PPG Paint colors

SUPER WHITE (NC-01)	WOOL SKEIN (NC-02)	BASKET BEIGE (NC-03)	ARGOS (NC-04)	ANTIQUE WHITE (NC-05)	WORLDLY GRAY (NC-06)	INTELLECTUAL GRAY (NC-07)	CEDAR (NC-08)
SVELTE SAGE (NC-09)	QUIVER TAN (NC-10)	ALEUTIAN BLUE (NC-11)	COASTAL PLAIN (NC-12)	BRACING BLUE (NC-13)	WHOLE WHEAT (NC-14)	ANDERSEN GREEN (NCAG) Trim Only	WINEBERRY (NCWB) Trim Only

Now Stocking

MELAMINE SHEETS & SHELVING



SHELVING

Edge Banded One Long Edge

- 3/4 X 12" (11-1/2") 8' AND 12' LENGTHS (34MEL12-8) (34MEL12-12)
- 3/4 X 16" (15-1/2") 8' AND 12' LENGTHS (34MEL16-8) (34MEL16-12)
- 3/4 X 24" (23-1/2") 8' AND 12' LENGTHS (34MEL24-8) (34MEL24-12)

PRE-DRILLED

3/4 X 16" (15-1/2") X 8' LENGTHS (34MEL16-8PD)

**SHELVING IS SQUARE EDGED

PRE-DRILLED SHELVING SPEC

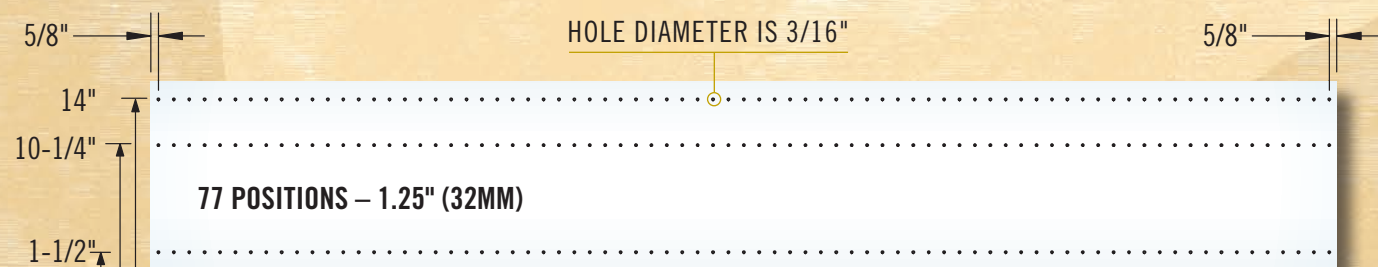

SHEETS

3/4 X 4 X 8 (49" X 97" WHITE 2 FACE) (34MEL4X8)

— Please call for pricing —



AVAILABLE IN 16' LENGTHS ONLY IN BOTH UNIT AND LESS THAN UNIT QUANTITIES

Garden State Lumber Products would like to introduce PLATINUM PROTECTED, the newest member of our ever-expanding offering of S4S trimboards. Providing unparalleled protection against rot, fungus, mold, mildew, and even termites, PLATINUM PROTECTED stands apart from other trim products for its multi-phase protection process that covers all four sides of the substrate and ensures the ultimate in defense against the natural environment. Merging the industry's highest quality Radiata substrate by CMPC Maderas with the expertise of the FrameGuard® Total treatment system and Garden State Lumber's proprietary Two-Coat priming system, PLATINUM PROTECTED is the new standard for environmentally friendly treated S4S Trimboards.

- | | |
|-----------------------------------|--|
| 1 x 3 (3/4 x 2-1/2) (XLP13PRF) | 5/4 x 4 (1-1/8 x 3-1/2) (XLP544PRF) |
| 1 x 4 (3/4 x 3-1/2) (XLP14PRF) | 5/4 x 6 (1-1/8 x 5-1/2) (XLP546PRF) |
| 1 x 5 (3/4 x 4-1/2) (XLP15PRF) | 5/4 x 8 (1-1/8 x 7-1/4) (XLP548PRF) |
| 1 x 6 (3/4 x 5-1/2) (XLP16PRF) | 5/4 x 10 (1-1/8 x 9-1/4) (XLP5410PRF) |
| 1 x 8 (3/4 x 7-1/4) (XLP18PRF) | 5/4 x 12 (1-1/8 x 11-1/4) (XLP5412PRF) |
| 1 x 10 (3/4 x 9-1/4) (XLP110PRF) | EDGE & CENTER BEAD: |
| 1 x 12 (3/4 x 11-1/4) (XLP112PRF) | 1 x 6 ECB (3/4 x 5-1/2) (XLPECB6PRF) |
| SHIPLAP: | V-GROOVE: |
| 1 x 6 (3/4 x 5-1/2) (SL6PRF) | 1 x 6 (3/4 x 5-1/2) (VG6PRF) |
| 1 x 8 (3/4 x 7-1/4) (SL8PRF) | |



AVAILABLE IN 12' AND 16' LENGTHS IN BOTH UNIT AND LESS THAN UNIT QUANTITIES:

Our Platinum XL line is the newest edition to our family of interior/exterior S4S trim boards. Made from a clear finger-joint Radiata substrate and vacuum coated with 2 passes of exterior bright white, acrylic latex water based primer, the Platinum XL line is ideal for both interior and exterior applications.

- | | |
|--|---|
| 1 x 2 (3/4 x 1-1/2) (LTX12PRF) | 5/4 x 4 (1-1/8 x 3-1/2) (LTX544PRF) |
| 1 x 3 (3/4 x 2-1/2) (LTX13PRF) | 5/4 x 6 (1-1/8 x 5-1/2) (LTX546PRF) |
| 1 x 4 (3/4 x 3-1/2) (LTX14PRF) | 5/4 x 8 (1-1/8 x 7-1/4) (LTX548PRF) |
| 1 x 6 (3/4 x 5-1/2) (LTX16PRF) | 5/4 x 10* (1-1/8 x 9-1/4) (LTX5410PRF) |
| 1 x 8 (3/4 x 7-1/4) (LTX18PRF) | 5/4 x 12* (1-1/8 x 11-1/4) (LTX5412PRF) |
| 1 x 10 (3/4 x 9-1/4) (LTX110PRF) | EDGE & CENTER BEADS: |
| 1 x 12 (3/4 x 11/1/4) (LTX112PRF) | 1 x 4 ECB* (9/16 x 3-1/2) (ECB4PRF) |
| <i>* Only Available in 16' lengths</i> | 1 x 6 ECB* (3/4 x 5-1/2) (ECB6PRF) |



AVAILABLE IN 16' LENGTHS IN BOTH UNIT AND LESS THAN UNIT QUANTITIES

The Platinum 5-0 line is our signature primed S4S trim board. Coated with a 6 mil (wet) coat of Randolph's oil alkyd primer, our Platinum 5-0 line is the most superior oil primed S4S trim board available in the market. The Randolph oil alkyd primer has been specially formulated to accept both oil and latex topcoats and offers outstanding protection against moisture and the elements.

- | | |
|-----------------------------------|--|
| 1 x 3 (3/4 x 2-1/2) (OIL13PRF) | 5/4 x 4 (1-1/8 x 3-1/2) (OIL544PRF) |
| 1 x 4 (3/4 x 3-1/2) (OIL14PRF) | 5/4 x 6 (1-1/8 x 5-1/2) (OIL546PRF) |
| 1 x 5 (3/4 x 4-1/2) (OIL15PRF) | 5/4 x 8 (1-1/8 x 7-1/4) (OIL548PRF) |
| 1 x 6 (3/4 x 5-1/2) (OIL16PRF) | 5/4 x 10 (1-1/8 x 9-1/4) (OIL5410PRF) |
| 1 x 8 (3/4 x 7-1/4) (OIL18PRF) | 5/4 x 12 (1-1/8 x 11-1/4) (OIL5412PRF) |
| 1 x 10 (3/4 x 9-1/4) (OIL110PRF) | |
| 1 x 12 (3/4 x 11/1/4) (OIL112PRF) | |



S4S SELECT STOCK

SKU	NOMINAL	ACTUAL SIZE	 PRIMED ULTRALITE MDF	 PVC BOARDS	 SOLID PINE	 PRIMED PINE 30 YEAR WARRANTY
D1	1/2 x 2	1/2 x 1-5/8			D1	
D2	1/2 x 3	1/2 x 2-1/2			D2	
D3	1/2 x 4	1/2 x 3-1/2			D3	
D4	1/2 x 6	1/2 x 5-1/2			D4	
D12	1 x 2	3/4 x 1-1/2			D12	
D13	1 x 3	3/4 x 2-1/2			D13	XLP13PRF
D14	1 x 4	3/4 x 3-1/2	D14MDF	D14PVC	D14	XLP14PRF
D15	1 x 5	3/4 x 4-1/2				XLP15PRF
D16	1 x 6	3/4 x 5-1/2	D16MDF	D16PVC	D16	XLP16PRF
D18	1 x 8	3/4 x 7-1/4	D18MDF	D18PVC	D18	XLP18PRF
D110	1 x 10	3/4 x 9-1/4	D110MDF	D110PVC	D110	XLP110PRF
D112	1 x 12	3/4 x 11-1/4	D112MDF	D112PVC	D112	XLP112PRF
D116	1 x 16	3/4 x 15-1/4				
D124	1 x 24	3/4 x 23-1/4				
D542	5/4 x 2	1-1/8 x 1-5/8			D542	
D543	5/4 x 3	1-1/8 x 2-1/2			D543	
D544	5/4 x 4	1-1/8 x 3-1/2		D544PVC	D544	XLP544PRF
D546	5/4 x 6	1-1/8 x 5-1/2		D546PVC		XLP546PRF
D548	5/4 x 8	1-1/8 x 7-1/4		D548PVC		XLP548PRF
D5410	5/4 x 10	1-1/8 x 9-1/4		D5410PVC		XLP5410PRF
D5412	5/4 x 12	1-1/8 x 11-1/4		D5412PVC		XLP5412PRF

SPECS AND LENGTH STRUCTURE

PRIMED ULTRALITE MDF primed 4 sides, 16' lengths

PVC finished all 4 sides (sealed edges), available in smooth/smooth and smooth/woodgrain, 18' lengths

SOLID PINE

C Select Solid Radiata – evens only 8' - 16' (1 x 4 thru 1 x 12)

C Select Solid Ponderosa Pine – 8' - 16' random length (1/2 x 2 thru 1/2 x 6 and 5/4 x 2 thru 5/4 x 4)

PLATINUM PROTECTED

Primed 4 Sides, 16' Lengths, 3 Coat Latex Prime, 30 Year Warranty. Also available 1x6 Edge & Center Bead (XLPECB6PRF), 1x6 V-groove (VG6PRF), 1x6 Shiplap (SL6PRF) & 1x8 Shiplap (SL8PRF)

S4S SELECT STOCK



 PRIMED PINE (PRIMED FJ)	 PRIMED POPLAR (PRIMED FJ)	 HARDWOODS POPLAR RED OAK MAPLE SAPELE CHERRY	ACTUAL SIZE	NOMINAL	SKU
D1PRF			1/2 x 1-5/8	1/2 x 2	D1
D2PRF			1/2 x 2-1/2	1/2 x 3	D2
D3PRF			1/2 x 3-1/2	1/2 x 4	D3
D4PRF			1/2 x 5-1/2	1/2 x 6	D4
LTX12PRF		D12 POP / OAK – Red Oak Only	3/4 x 1-1/2	1 x 2	D12
LTX13PRF	D13PP	D13 POP / OAK – Red Oak Only	3/4 x 2-1/2	1 x 3	D13
LTX14PRF*	D14PP	D14 POP / OAK / SAP / MA / CH	3/4 x 3-1/2	1 x 4	D14
LTX15PRF			3/4 x 4-1/2	1 x 5	D15
LTX16PRF*	D16PP	D16 POP / OAK / SAP / MA / CH	3/4 x 5-1/2	1 x 6	D16
LTX18PRF*	D18PP	D18 POP / OAK / SAP / MA / CH	3/4 x 7-1/4	1 x 8	D18
LTX110PRF*	D110PP	D110 POP / OAK / SAP / MA / CH	3/4 x 9-1/4	1 x 10	D110
LTX112PRF*	D112PP	D112 POP / OAK / SAP / MA / CH	3/4 x 11-1/4	1 x 12	D112
	D116PP		3/4 x 15-1/4	1 x 16	D116
	D124PP		3/4 x 23-1/4	1 x 24	D124
			1-1/8 x 1-5/8	5/4 x 2	D542
			1-1/8 x 2-1/2	5/4 x 3	D543
LTX544PRF*	D544PP	D544 POP / OAK / SAP / MA / CH	1-1/8 x 3-1/2	5/4 x 4	D544
LTX546PRF*	D546PP	D546 POP / OAK / SAP / MA / CH	1-1/8 x 5-1/2	5/4 x 6	D546
LTX548PRF	D548PP	D548 POP / OAK / SAP / MA / CH	1-1/8 x 7-1/4	5/4 x 8	D548
LTX5410PRF	D5410PP	D5410 POP / OAK / SAP	1-1/8 x 9-1/4	5/4 x 10	D5410
LTX5412PRF	D5412PP	D5412 POP / OAK / SAP	1-1/8 x 11-1/4	5/4 x 12	D5412

SPECS AND LENGTH STRUCTURE

PRIMED PINE primed 4 sides, 16' lengths Available 2 coat latex

* also available in 12' lengths

PRIMED POPLAR primed 4 sides - 16' lengths 5/4" boards are 1-1/16" thick

SOLID POPLAR clear 4 face, 8' thru 16'

RED OAK clear 1 face and 2 edges, 3/4" boards available in even lengths 8' thru 16', 1-1/16" boards available random length 8' thru 16'

WHITE HARD MAPLE clear 1 face and 2 edges, random length 8' thru 16'

SAPELE (MAHOGANY) clear 1 face and 2 edges, random length 8' thru 16'

CHERRY clear 1 face and 2 edges, random length 8' thru 16'

SHEET STOCK — AND — PANEL PRODUCTS



**IN STOCK FOR
IMMEDIATE SHIPMENT**





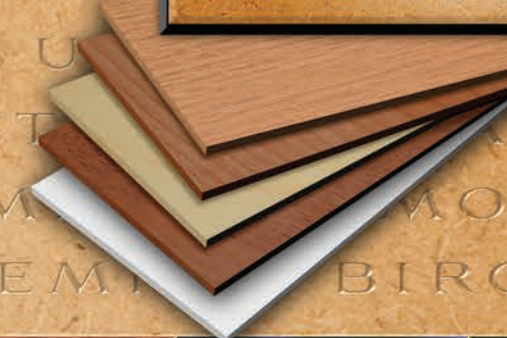





NO MINIMUM QUANTITIES

SHEET STOCK — AND — PANEL PRODUCTS



**IN STOCK FOR
IMMEDIATE SHIPMENT**

NO MINIMUM QUANTITIES

THICKNESS	SHEET SIZE	 ULTRALITE MDF	 MOISTURE RESISTANT MDF	 RADIATA A/C PLY	 LUAN PLYWOOD	 MDF BEADBOARD (5 PATTERNS)	 BIRCH OAK	 AROMATIC CEDAR CHIPBOARD	 PVC SHEETS	SHEET SIZE	THICKNESS
1/8"	4' x 8'	18MDF*			18LUAN					4' x 8'	1/8"
1/4"	4' x 8'	14MDF*	14MDF-MRI	14AC	14LUAN52 & 14LUAN55		14BIR / 14OAK	CEDARCB	14PVC	4' x 8'	1/4"
3/8"	4' x 8'	38MDF		38AC/38BP					38PVC	4' x 8'	3/8"
	4' x 10'								38PVC10	4' x 10'	
1/2"	4' x 8'	12MDF	12MDF-MRI	12AC			12BIR / 12OAK		12PVC	4' x 8'	1/2"
	4' x 10'	12MDF10							12PVC10	4' x 10'	
	4' x 12'	12MDF12							12PVC12	4' x 12'	
	4' x 18'								12PVC18	4' x 18'	
5/8"	4' x 8'	58MDF		58AC/58T11					58PVC	4' x 8'	5/8"
	4' x 8'	34MDF	34MDF-MRI	34AC			34BIR / 34BIRUV2S / 34OAK		34PVC	4' x 8'	
3/4"	4' x 10'	34MDF10							34PVC10	4' x 10'	3/4"
	4' x 12'	34MDF12							34PVC12	4' x 12'	
	4' x 16'	34MDF16								4' x 16'	
	4' x 18'								34PVC18	4' x 18'	
1"	4' x 8'	1MDF		1AC					1PVC	4' x 8'	1"
	4' x 10'								1PVC10	4' x 10'	
	4' x 12'								1PVC12	4' x 12'	
	4' x 18'								1PVC18	4' x 18'	
1-1/4"	4' x 8'	54MDF								4' x 8'	1-1/4"
1-1/2"	4' x 8'	64MDF								4' x 8'	1-1/2"

*LITE MDF 40 LB/CUBIC FT

RADIATA A/C PLY
3/8" Available In Beaded Ply - 2" on Center,
5/8" Available in Texture 111 - 8" on Center

MDF BEADBOARD
Also Available in PVC &
Moisture resistant MDF

PREMIUM BIRCH
1/4" = C3 Grade, 1/2" = C2 Premium,
34BIR = C2 Classic Birch
34BIRUV2S = Prefinished U.V. Coated 2 Sides

AROMATIC CEDAR CHIPBOARD
1/4" x 4' x 8'



Introducing

NuCedar Mills®

finely crafted exteriors



SPRING 2019

ASK ABOUT OUR OTHER PRODUCTS:



the
Prestige Line
ULTRA LITE MDF MOULDINGS

The
ESTATE
SERIES

The
DESIGNER
COLLECTION
PRIMED POPLAR MOULDINGS

THE METRO
COLLECTION
TIMELESSLY MODERN MOULDINGS

nantucket
beardboard

CUSTOM ARCHES
& Architectural Accents

NORTHEAST REGION:

22 MULLER ROAD, OAKLAND, NEW JERSEY 07436

PHONE: (800)526-4708

SOUTHEAST REGION:

810 BISTLINE DRIVE, WEST COLUMBIA, SOUTH CAROLINA 29172

\$11.11

PHONE: (800)296-0288

WWW.GARDENSTATELUMBER.COM