

# 2020 FULL-LINE CATALOG



Window & Door Trim | Mouldings | Decorative Millwork | Louvers & Gable Vents | Column Wraps | Rail Systems | Balustrades, Porch Posts & Columns



# Table of Contents

---



14

## Window & Door Trim

- Crossheads & Pediments
- Pilasters
- Window & Door Trim
- Shutters
- Board & Louvered Panels

82

## Mouldings

- Smooth Flat Trim
- Wood-Grained Flat Trim
- Mouldings
- Moulding Accessories
- Crown E-Vent

120

## Decorative Millwork

- Brackets, Corbels & Dentil Blocks
- Knee Braces & Rafter Tails
- Trellis System
- Beams
- Beam Mantels
- Gable Pediments
- Tile Vents

184

## Louvers & Gable Vents

- Decorative Louvers
- Functional Louvers
- Louver Trim

## 202

### Column Wraps

- Square PVC Column Wrap
- Tapered PVC Column Wrap
- Square Wood-Grained Column Wrap
- Tapered Wood-Grained Column Wrap
- Cap & Base Accessories
- Structural Post
- Installation Materials



## 220

### Rail Systems

- Straight & Stair Rail Kits
- Complete Post Kits
- Post Sleeves
- Gate Kits
- Accessories

## 232

### Balustrades, Porch Posts & Columns

- Balustrade Systems
- Structural Column
- Structural Porch Posts
- Stone Balustrade
- Stone Half-Round Column



## 258

### Service Guidelines

- Ordering & Delivery
- Custom Projects, Large Projects & Takeoffs
- Product Return Policies
- Specialty Options
- Considerations for Installation



## DISCOVER THE FYPON ADVANTAGE

Fypon makes homes better with durable, weather-resistant decorative millwork solutions that are engineered for ease of installation, provide long-lasting low maintenance, deliver performance for long-term value and are backed by a lifetime limited warranty for peace of mind.

## THE RESOURCES YOU NEED

Building professionals trust Fypon to deliver outstanding customer service and support.

We provide:

- An industry-first quote package program with quantity pricing tool.
- Support from Fypon experts and answers to common installation questions.
- Takeoff services for historical restorations, replicas or any unique profile that fits your home or commercial application.

For more information, contact [CPS@fypon.com](mailto:CPS@fypon.com).

## TAKEOFF SERVICES FOR ARCHITECTS & BUILDERS

Fypon offers architects and builders a free takeoff service for projects of at least \$10,000, including historical restorations, replicas and other applications.

For more information, contact [CPS@fypon.com](mailto:CPS@fypon.com) or call 1.855.397.6647.

## CUTTING & MILLING

Fypon polyurethane products can be cut and trimmed with standard woodworking tools, including table saws, circular saws, jig saws, band saws and miter saws. Trimming product will remove the smooth finish and create an exposed polyurethane edge. This edge must be primed to protect the exposed polyurethane. Fypon polyurethane products must be finished with paint or stain within 90 days of installation to protect the product from discoloration from the sun.

For more information on the installation and care of Fypon products, visit [fypon.com](http://fypon.com).

## INSTALL

Installation instructions for all Fypon products can be found on our website at <http://www.fypon.com/support/installation/guides.aspx>.

## REMEMBER TO ORDER ADHESIVE

A urethane-based adhesive must be used on all polyurethane joint surfaces. Fypon recommends [Locite® PL Premium® Adhesive](#). For PVC products, such as column wraps, Fypon recommends [Duo-Sil® adhesive](#) and caulk. See pages 262 and 205 for ordering information.



# 2020 Trends

---

Celebrate style with our new and featured products.

Our new and featured products blend beauty and durability, providing low-maintenance, on-trend looks for any home.



The Curated Casual trend draws in homeowners who want sophisticated styling that's livable. The popular Farmhouse aesthetic is taken to the next level with a more polished design and refined styling. Homes that represent the Curated Casual trend often feature tailored trim work, artisan accents and high-contrast elements to create an effortless statement of style.

The Modern Mix trend encompasses eclectic looks that blend unexpected details with contemporary aesthetics to create a more relaxed interpretation of modern design. Homes that represent the Modern Mix trend often feature linear lines, textured accents and eclectic angles.

The Lively Heritage trend appeals to homeowners who crave classic looks with a breath of fresh air. Traditional design relaxes to focus on careful style mixing, bringing in rich saturated colors, bold shapes and streamlined aesthetics. Homes that represent the Lively Heritage trend often feature tall peaks, natural wood accents and warehouse windows that create a light and airy space while still preserving historic design roots.

## CURATED CASUAL

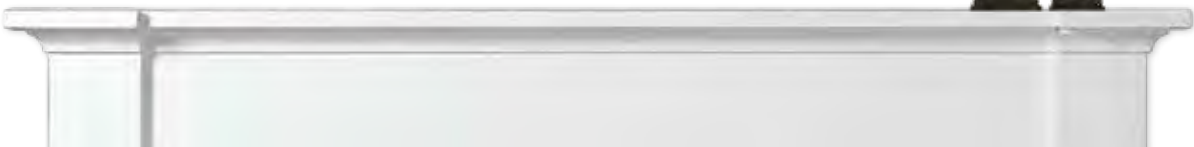
CLEAN  
SOPHISTICATED  
REFINED



A refined evolution of casual.

Pure Styling | Polished Design | High Contrast

# modern MIX

MINIMAL  
UNEXPECTED  
ECLECTIC



A blend of contemporary design with unexpected eclectic touches



Inviting Aesthetics | Natural Materials | Warm Accents

# *Lively* HERITAGE

FRESH  
DRAMATIC  
CLASSIC



A bold take on traditional.



Style Mixing | Streamlined Design | Bold Shapes

# 2020 New Products

---

## SMOOTH BEAMS

Add architectural charm and a clean, classic aesthetic to any home with Fypon® Smooth Beams. Our smooth beams can be used to create a striking focal point and can be painted any color to complement a home's décor. See page 160 for more details.

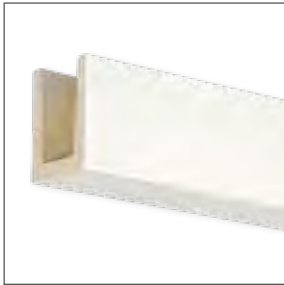

## FLAT-PACK COLUMN WRAPS

Designed for easy installation around an existing structural support, Fypon Flat-Pack Column Wraps add an elegant finishing touch to any home. Flat-pack column wraps ship unassembled for better handling and utilization of less storage space. Ease of assembly and installation is maintained, without sacrificing style or performance. See pages 211, 214 and 218 for more details.





## EVERCEDAR WOOD-GRAINED FLAT-PACK COLUMN WRAPS

Fypon Wood-Grained Flat-Pack Column Wraps provide the charming, on-trend aesthetic of real cedar without the hassle. Designed for easy installation around an existing structural support, our wood-grained column wraps offer the same stability and performance as our smooth column wraps. See pages 207 and 208 for more details.



# Featured Products

---

## CRAFTSMAN COVE CROSSHEAD

Our Craftsman Cove crosshead captures the look of a wood built-up crosshead with cove, top and bottom trim. Optional end caps are available to add an authentic Arts & Crafts style. See page 23 for more details.



## CRAFTSMAN STEP CROSSHEAD

The simplistic design of our Craftsman Step crosshead emphasizes the elements of early Craftsman-style homes. See page 27 for more details.



## MODERN FARMHOUSE SHAKER-STYLE SHUTTERS

Discover casual, practical design with a modern twist. Our Modern Farmhouse Shaker-style shutters deliver an authentic look with subtle elegance. See page 58 for more details.



## BEAM MANTELS AND SHELVES

Add rustic charm to the interior of any home with Fypon® Beam Mantels and Shelves. Choose from two realistic wood grains, Rough Sawn or Hand Hewn. See page 172 for more details.



## RAFTER TAILS

Fypon Rafter Tails feature an updated Rough Sawn Cedar finish, offering a more authentic look. Choose from five new profile designs including Straight, Cove, Slant, Bullnose and Scroll. See page 156 for more details.





FYPON

PRODUCTS

RESOURCES

IDEAS

ABOUT US

FIND A DEALER

LOG IN

SUPPORT

Search

Distinctly Yours

Top-quality moulding and millwork for your home.

SHOP NOW

# Fypon.com has a new look!

Fypon.com has been completely redesigned to offer a faster, user-friendly experience. The updated site provides a wide array of improved features, including:



Enhanced search capabilities.



Comprehensive tools and resources for trade professionals and homeowners.



Ratings and reviews for individual products.



Mobile friendly.



Simplified Navigation



Detailed Product Pages

# Window & Door Trim



AN UNFORGETTABLE FIRST IMPRESSION.

Transform the look of any home with Fypon® Window and Door Trim. Designed to work together, these pieces are quick and easy to install.



Crossheads .....	18
Pediments .....	36
Pilasters .....	45
Window Trim .....	52
Window Panels .....	54
Dormer Trim System .....	54
Keystones .....	55
Smooth Shutters .....	56
<b>NEW</b> Smooth Shutter Board Fabrication Panels.....	62
Wood-Grained Shutters.....	64
Wood-Grained Shutter Board Fabrication Panels.....	80
Shutter Accessories .....	81

**Product Shown:**

Flat Trim

Dentil Blocks

Distinction Crosshead

Shaker-Style Shutters

PremiumSelect Square Column Wraps with Raised Panels

**FYPON**<sup>®</sup>

# Window & Door Trim

## HOW TO USE THIS SECTION

Where applicable, part numbers are shown for products with attached accessories, or other available unattached accessories are referenced or shown with the product.

## HOW TO ORDER

### Door Trim & Entrance Systems

When ordering door trim, first measure the door unit to be trimmed. The unit can be measured with or without brickmould; however the brickmould is essential when using a storm door. Next, choose the desired pilaster style and size. Finally, choose a pediment or crosshead that is wide enough to span the opening plus the brickmould and pilasters or flat trim. Add desired accessories to complete the look.

### Window & Door Trim Accessories

Keystones, dentil trim, trim strip and bottom trim accessories are available attached to standard products as fabricated products. A keystone can also be ordered as an unattached accessory.



#### How to Order Trimmable Crosshead

#### Example

- |   |   |   |
|---|---|---|
| 1 | Determine height.   | 6" high                                     |
| 2 | Determine breast board width of crosshead.  | 36" width                                   |
| 3 | Select end cap width. End cap widths should coordinate with pilaster or moulding on either side of door / window. If no moulding is used, then any end cap can be selected. | CHC4X6 (Coordinating over 3-1/2" flat trim) |
| 4 | Calculate trimmable crosshead; account for end cap.<br>Crosshead breast board width - (end cap back surface x 2) = trimmable crosshead                                      | 36" - (2.5" x 2) = 31" required*            |
| 5 | Select trimmable crosshead.   | CHT36X6                                     |
| 6 | Optional: Select accessory moulding / keystone.   | K6M and MLD716-12                           |

\*End cap back surface.



# WINDOW & DOOR TRIM APPLICATIONS

**Distinction Crosshead with End Caps**

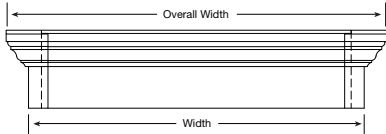

**Craftsman Cove Crosshead with End Caps**



**Classic Crosshead without Accessories**



**Classic Crosshead with Accessories**

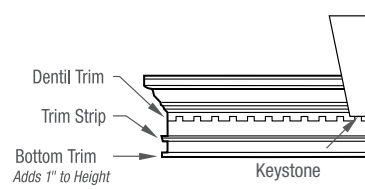

Note: A keystone cannot be used when combining a crosshead with a pediment.

**Window Trim Terminology**

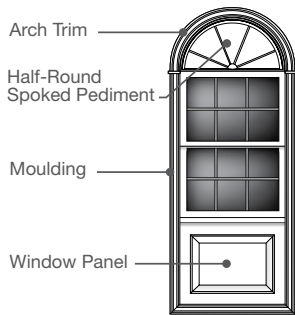

**Keystone Options**

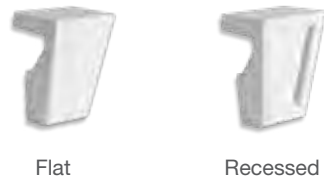

**Crosshead Options for Entry Way**

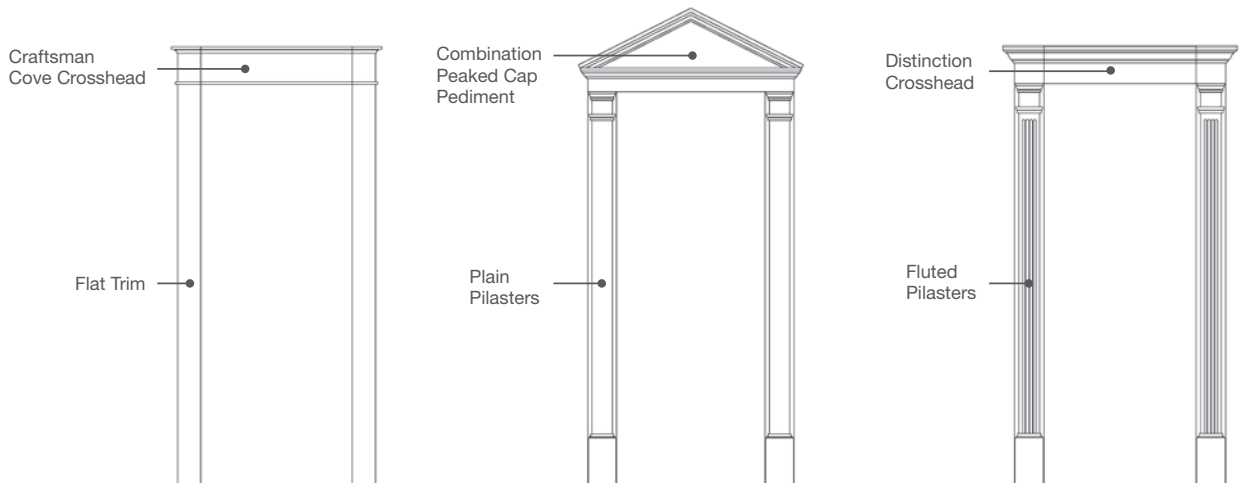

# DISTINCTION CROSSHEAD



# Ready-to-Install

- Our Distinction crosshead line includes heights measuring 6" and 9". Widths for 6" are 24" - 144", and widths for 9" are 24" - 216", both in 1" increments.
- End cap comes standard with 1-1/2" width and overlaps crosshead.



## 6" & 9" Distinction Crosshead

Ready-to-Install

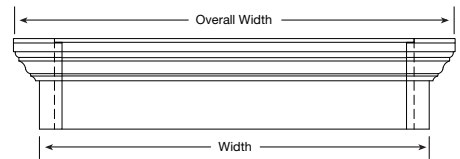

### Part Number Logic:

**CH24X6EC**

<p><b>[Profile]</b> CH = Crosshead</p>	<p><b>[Breast Board Width]</b> (1" increments) 24 = 24" [Minimum] 144 = 144" [Maximum for 6" high] 216 = 216" [Maximum for 9" high]</p>	<p><b>[Height]</b> 6 = 6" 7 = 7" (BT option only) 9 = 9" 10 = 10" (BT option only)</p>
		<p><b>[Configuration]</b> BT = Bottom Trim D = Dentil Trim K = Keystone R = Routed</p>

## Distinction Crosshead with Coordinating Pilaster Widths

Ready-to-Install

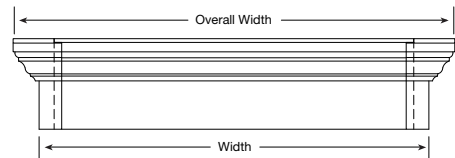

### Part Number Logic:

**CH51X6EC5**

<p><b>[Profile]</b> CH = Crosshead</p>	<p><b>[Pilaster Width*]</b> 5 = 5-1/4" 7 = 7" 9 = 9"</p>	<p><b>[Crosshead Width]</b> (1" increments) 51 = 51" [Minimum] 96 = 96" [Maximum]</p>
	<p>EC = End Cap</p>	<p><b>[Crosshead Height]</b> 6 = 6" 9 = 9"</p>

If pilasters are to be included as part of the opening, remember the following:

- 1) Remember to account for lighting, door bells, mailboxes or any other item that could dictate the width of the pilaster.
- 2) Don't forget to take into account brickmould, if applicable
- 3) Breast board of crosshead should fit over the entire width of the right and left pilasters.

\*The last character in the part number coordinates with the pilaster width.

# Trimmable

- Distinction trimmable crossheads are available in heights measuring 6" and 9", and widths measuring 36", 48", 144" and 216".
  - 36" and 48" widths allow for ease of handling and quick installation.
  - 144" and 216" widths can be cut to any length, minimizing waste in the field.
- End caps overlap the trimmable crosshead.
- End caps may be routed.

## 6" & 9" Distinction Crosshead



Trimmable

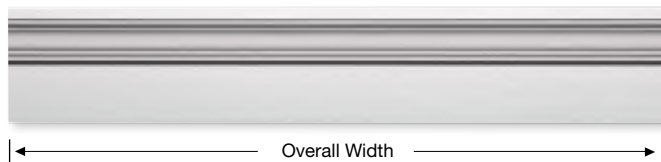

6" Height		9" Height		Overall Width
CHT36X6		CHT36X9		36"
CHT48X6		CHT48X9		48"
CHT144X6		CHT144X9		144- <sup>3</sup> / <sub>8</sub> "
CHT216X6		CHT216X9		216- <sup>5</sup> / <sub>8</sub> "

## End Caps

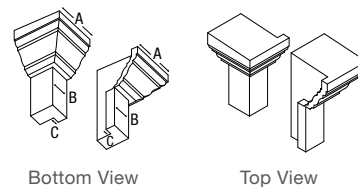



6" Height			9" Height			Breast Board Width (B)	Rabbit Width (C)
Qty 1	Qty 5	Overall Width (A)	Qty 1	Qty 5	Overall Width (A)		
CHC2X6	CHC2X6-5	3- <sup>1</sup> / <sub>4</sub> "	CHC2X9	CHC2X9-5	4- <sup>1</sup> / <sub>4</sub> "	1- <sup>1</sup> / <sub>2</sub> "	1/2"
CHC4X6	CHC4X6-5	5- <sup>1</sup> / <sub>4</sub> "	CHC4X9	CHC4X9-5	6- <sup>1</sup> / <sub>4</sub> "	3- <sup>1</sup> / <sub>2</sub> "	1"
CHC7X6*	CHC7X6-5*	8- <sup>3</sup> / <sub>4</sub> "	CHC7X9*	CHC7X9-5*	9- <sup>3</sup> / <sub>4</sub> "	7"	4"
CHC11X6*	CHC11X6-5*	12- <sup>3</sup> / <sub>4</sub> "	CHC11X9*	CHC11X9-5*	13- <sup>3</sup> / <sub>4</sub> "	11"	4"

Note: End caps are sold in pairs.  
\*Trimmable up to 3-<sup>1</sup>/<sub>2</sub>".



## Distinction Accessories

	Accessory	6" Height	9" Height
	Keystone	K6M	K9M
	Dentil	MLD357-8	MLD358-8
	Bottom Trim	MLD716-12	MLD758-12

# CRAFTSMAN COVE CROSSHEAD



# Ready-to-Install

- Our expanded Craftsman Cove crosshead line includes heights measuring 9" and widths measuring 24" - 216", in 1" increments.
- End caps come standard with 3-1/2" width and overlap crosshead.
- End caps may be routed.

## 9" Craftsman Cove Crosshead



### Part Number Logic:

**CHCC24X9BTEC\_\_**

<p><b>[Profile]</b>  <b>CHCC</b> = Craftsman Cove Crosshead</p>	<p><b>[Breast Board Width]</b>          (1" increments)  <b>24</b> = 24" [Minimum]  <b>216</b> = 216" [Maximum]</p>	<p><b>[Configuration]</b>  <b>R</b> = Routed  <b>EC</b> = End Cap  <b>BT</b> = Bottom Trim  <b>[Height]</b>  <b>9</b> = 9"</p>	<p>If flat trim is to be included as part of the opening, remember the following:</p> <ol style="list-style-type: none"> <li>1) Account for lighting, door bells, mailboxes or any other item that could dictate the width of the trim.</li> <li>2) Don't forget to take into account brickmould, if applicable.</li> <li>3) Breast board of the crosshead or crosshead end cap should fit over both the left and right trim pieces.</li> </ol>
---	---	--	---





## How to Order

- ① Determine height.
- ② Determine breast board width. When installing over side trim CHCCC6X9BT coordinates best with 5-<sup>1</sup>/<sub>4</sub>" pilaster and 5-<sup>1</sup>/<sub>2</sub>" wide trim.
- ③ Select end cap width.





# Trimable

- Our expanded Craftsman Cove crosshead line includes a 9" height, measuring 36", 48", 144" and 216".
- End caps do not come standard with trimmable product. They must be ordered. 3-1/2" or 5-1/2" end caps are optional; complement standard trim widths.
- End caps overlap crosshead.
- Crosshead and end caps may be routed.

## 9" Craftsman Cove Crosshead

Trimmable

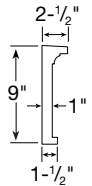
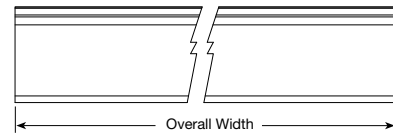

Part Number	Overall Width
CHCCT36X9BT	36"
CHCCT48X9BT	48"
CHCCT144X9BT	144"
CHCCT216X9BT	216"

## 9" Craftsman Cove End Caps



3-1/2" End Caps



5-1/2" End Caps

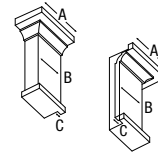

Bottom View

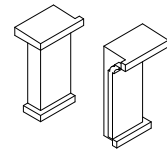

Top View

Part Number	Overall Width (A)	Width (B)	Rabbet Width (C)
CHCCC4X9BT	5"	3-1/2"	1/2"
CHCCC4X9BT-5*			
CHCCC6X9BT	7"	5-1/2"	1/2"
CHCCC6X9BT-5*			

\*Pack quantity of 5 pair.  
End cap overlaps the trimmable crosshead.

# CRAFTSMAN STEP CROSSHEAD



## 6" Craftsman Step Crosshead

Trimvable

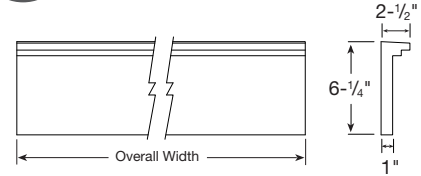

Part Number	Overall Width	Height
CHCST36X6	36"	6-1/4"
CHCST48X6	48"	6-1/4"
CHCST144X6	144- <sup>3</sup> / <sub>8</sub> "	6-1/4"
CHCST216X6	216- <sup>5</sup> / <sub>8</sub> "	6-1/4"

## 8" Craftsman Step Crosshead

Trimvable

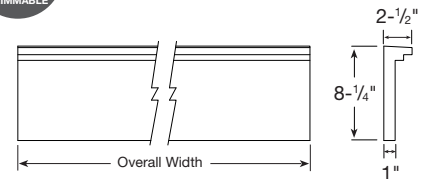

Part Number	Overall Width	Height
CHCST36X8	36"	8-1/4"
CHCST48X8	48"	8-1/4"
CHCST144X8	144- <sup>3</sup> / <sub>8</sub> "	8-1/4"
CHCST216X8	216- <sup>5</sup> / <sub>8</sub> "	8-1/4"



### PRO TIP

Fabricate trimvable crosshead to create mitered ends for a traditional look.

Note: Craftsman Step crossheads may be routed.

Parts may be required to ship LTL (less than truckload) based on size and overall dimensions.

CLASSIC CROSSHEAD



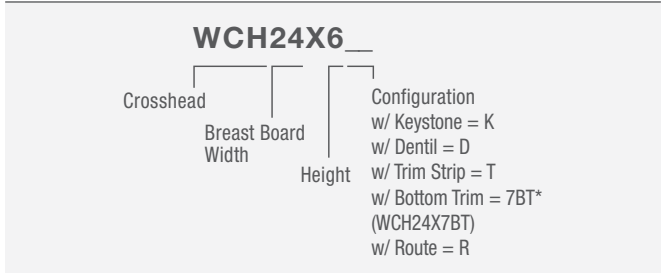

## 6" Classic Crosshead

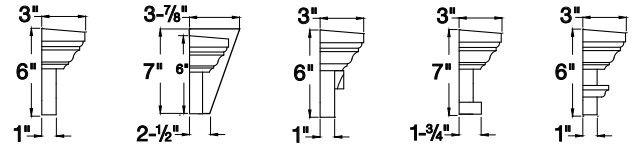
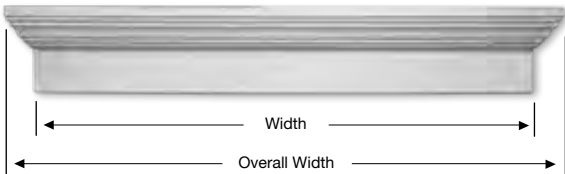

Standard    w/ Keystone K6M    w/ Dentil Trim    w/ Bottom Trim\*    w/ Trim Strip

Part Number	Width	Overall Width
WCH24X6	24"	27-1/2"
WCH28X6	28"	31-1/2"
WCH30X6	30"	33-1/2"
WCH31X6	31"	34-1/2"
WCH32X6	32"	35-1/2"
WCH33X6	33"	36-1/2"
WCH34X6	34"	37-1/2"
WCH35X6	35"	38-1/2"
WCH36X6	36"	39-1/2"
WCH37X6	37"	40-1/2"
WCH38X6	38"	41-1/2"
WCH40X6	40"	43-1/2"
WCH41X6	41"	44-1/2"
WCH43X6	43"	46-1/2"
WCH44X6	44"	47-1/2"
WCH46X6	46"	49-1/2"
WCH47X6	47"	50-1/2"
WCH48X6	48"	51-1/2"
WCH50X6	50"	53-1/2"
WCH51X6	51"	54-1/2"
WCH52X6	52"	55-1/2"
WCH54X6	54"	57-1/2"
WCH56X6	56"	59-1/2"

Part Number	Width	Overall Width
WCH60X6	60"	63-1/2"
WCH64X6	64"	67-1/2"
WCH66X6	66"	69-1/2"
WCH67X6	67"	70-1/2"
WCH68X6	68"	71-1/2"
WCH72X6	72"	75-1/2"
WCH73X6	73"	76-1/2"
WCH74X6	74"	77-1/2"
WCH76X6	76"	79-1/2"
WCH78X6	78"	81-1/2"
WCH79X6	79"	82-1/2"
WCH80X6	80"	83-1/2"
WCH80.5X6	80-1/2"	84"
WCH84X6	84"	87-1/2"
WCH86X6	86"	89-1/2"
WCH87X6	87"	90-1/2"
WCH96X6	96"	99-1/2"
WCH100X6	100"	103-1/2"
WCH103X6	103"	106-1/2"
WCH104X6	104"	107-1/2"
WCH108X6	108"	111-1/2"
WCH110X6	110"	113-1/2"
WCH144X6	144"	147-1/2"

\*Bottom trim adds 1" to overall height.

Part Number Logic:

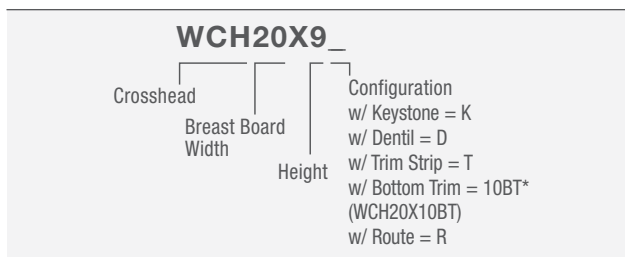

## 9" Classic Crosshead

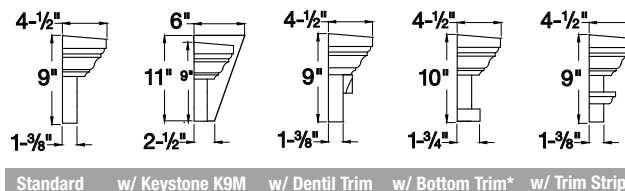
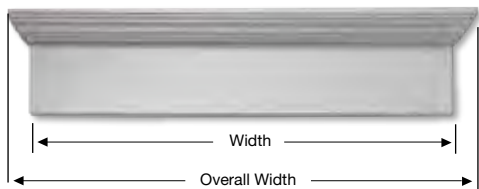

Part Number	Width	Overall Width
WCH20X9	20"	25-1/2"
WCH24X9	24"	29-1/2"
WCH25X9	25"	30-1/2"
WCH26X9	26"	31-1/2"
WCH27X9	27"	32-1/2"
WCH28X9	28"	33-1/2"
WCH29X9	29-5/8"	35-1/8"
WCH30X9	30-1/4"	35-3/4"
WCH32X9	32"	37-1/2"
WCH33X9	33"	38-1/2"
WCH34X9	34"	39-1/2"
WCH35X9	35"	40-1/2"
WCH36X9	36"	41-1/2"
WCH37X9	37"	42-1/2"
WCH38X9	38"	43-1/2"
WCH40X9	40"	45-1/2"
WCH41X9	41"	46-1/2"
WCH42X9	42"	47-1/2"
WCH43X9	43"	48-1/2"
WCH44X9	44"	49-1/2"
WCH45X9	45"	50-1/2"
WCH46X9	46"	51-1/2"
WCH48X9	48"	53-1/2"
WCH49X9	49"	54-1/2"
WCH50X9	50"	55-1/2"
WCH54X9	54"	59-1/2"

Part Number	Width	Overall Width
WCH56X9	56"	61-1/2"
WCH58X9	58"	63-1/2"
WCH60X9	60"	65-1/2"
WCH62X9	62"	67-1/2"
WCH64X9	64"	69-1/2"
WCH65X9	65"	70-1/2"
WCH66X9	66"	71-1/2"
WCH67X9	67"	72-1/2"
WCH68X9	68"	73-1/2"
WCH69X9	69"	74-1/2"
WCH70X9	70"	75-1/2"
WCH72X9	72"	77-1/2"
WCH73X9	73"	78-1/2"
WCH74X9	74"	79-1/2"
WCH75X9	75"	80-1/2"
WCH76X9	76"	81-1/2"
WCH77X9	77"	82-1/2"
WCH78X9	78"	83-1/2"
WCH80X9	80"	85-1/2"
WCH81X9	81"	86-1/2"
WCH82X9	82"	87-1/2"
WCH84X9	84"	89-1/2"
WCH85X9	85"	90-1/2"
WCH86X9	86"	91-1/2"
WCH88X9	88"	93-1/2"
WCH90X9	90"	95-1/2"

\*Bottom trim adds 1" to overall height.

Parts may be required to ship LTL (less than truckload) based on size and overall dimensions.



## 9" Classic Crosshead

Part Number	Width	Overall Width
WCH93X9	93"	98-1/2"
WCH96X9	96"	101-1/2"
WCH99X9	99"	104-1/2"
WCH100X9	100"	105-1/2"
WCH101X9	101"	106-1/2"
WCH103X9	103"	108-1/2"
WCH104X9	104"	109-1/2"
WCH108X9	108"	113-1/2"
WCH110X9	110"	115-1/2"
WCH112X9	112"	117-1/2"

Part Number	Width	Overall Width
WCH113X9	113"	118-1/2"
WCH120X9	120"	125-1/2"
WCH124X9	124"	129-1/2"
WCH144X9	144"	149-1/2"
WCH192X9	192"	197-1/2"
WCH196X9	196"	201-1/2"
WCH197X9	197"	202-1/2"
WCH200X9	200"	205-1/2"
WCH204X9	204"	209-1/2"
WCH207X9	207"	212-1/2"

Part Number Logic:

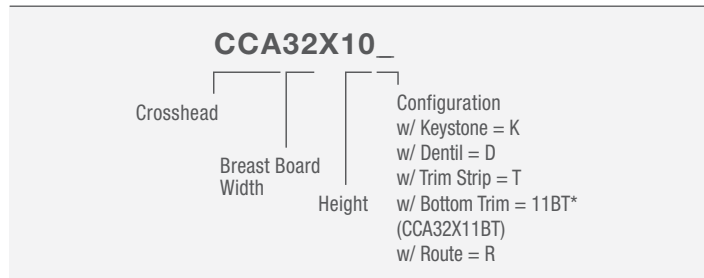

## 10" Classic Crosshead

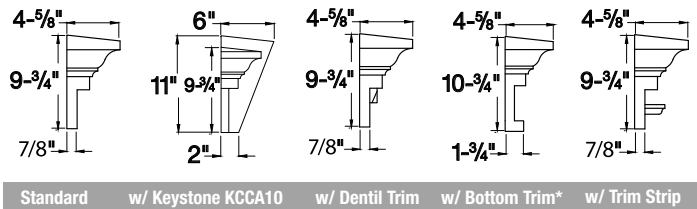
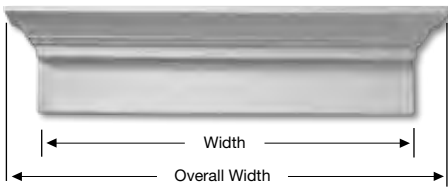

Part Number	Width	Overall Width
CCA32X10	32"	37-1/4"
CCA34X10	34"	39-1/4"
CCA36X10	36"	41-1/4"
CCA40X10	40"	45-1/4"
CCA47X10	47"	52-1/4"
CCA52X10	52"	57-1/4"
CCA64X10	64"	69-1/4"
CCA72X10	72"	77-1/4"
CCA100X10	100"	105-1/4"
CCA106X10	106"	111-1/4"
CCA199X10	199"	204-1/4"
CCA200X10	200"	205-1/4"

\*Bottom trim adds 1" to overall height.

Parts may be required to ship LTL (less than truckload) based on size and overall dimensions.





**Part Number Logic:**

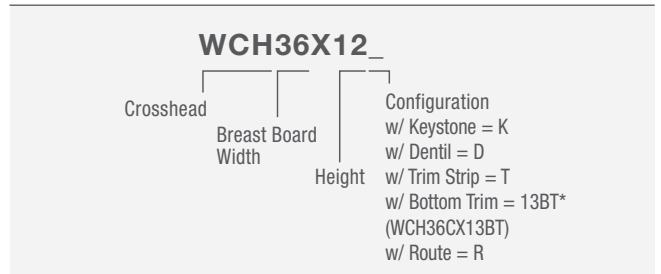

## 12" Classic Crosshead

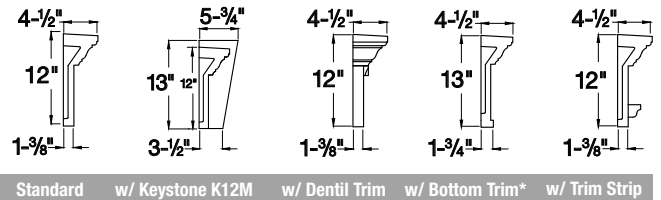
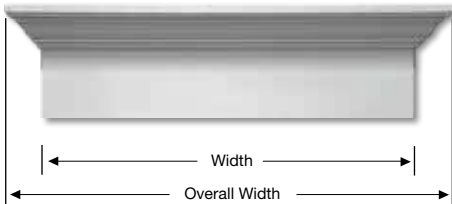

Part Number	Width	Overall Width
WCH36X12	36"	41-1/2"
WCH37X12	37-5/8"	43-1/8"
WCH40X12	40"	45-1/2"
WCH44X12	44"	49-1/2"
WCH48X12	48"	53-1/2"
WCH54X12	54"	59-1/2"
WCH56X12	56"	61-1/2"
WCH64X12	64"	69-1/2"

Part Number	Width	Overall Width
WCH72X12	72"	77-1/2"
WCH96X12	96"	101-1/2"
WCH102X12	102"	107-1/2"
WCH104X12	104"	109-1/2"
WCH144X12	144"	149-1/2"
WCH200X12	200"	205-1/2"
WCH203X12	203"	208-1/2"
WCH213X12	213"	218-1/2"

# 6" Crosshead Arch

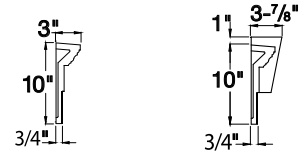
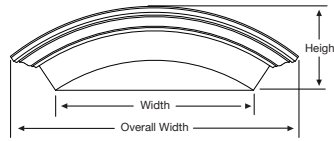

Standard      w/ Keystone K6M

Part Number	Part Number w/ Keystone	Width	Overall Width	Height
WCH6ARS34X10	WCH6ARS34X10K	34"	42-7/8"	10"

### Part Number Logic:

**WCHARS33X14**

- Crosshead
- Breast Board Width
- Height
- Configuration w/ Keystone = K  
w/ Bottom Trim = 15BT\*  
(WCHARS33X15BT)

# 9" Crosshead Arch

Solid

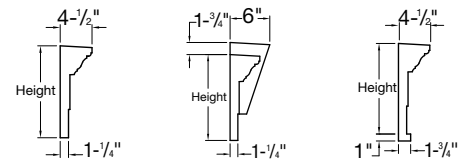
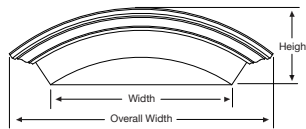

Standard      w/ Keystone K9M      w/ Bottom Trim\*

Part Number	Width	Overall Width	Height
WCHARS33X14	33"	48-1/8"	14"
WCHARS36X13	36"	49-1/4"	13"
WCHARS43X13	43"	55-1/4"	13"
WCHARS54X16	54"	68-1/8"	16"
WCHARS64X14	64"	75-1/2"	14"
WCHARS68X12	68"	77-1/4"	12"
WCHARS68X16	68"	80-7/8"	16"
WCHARS72X13	72"	82-1/8"	13"
WCHARS75X13	75"	84-7/8"	13-3/8"
WCHARS80X15	80"	91-1/4"	15"
WCHARS84X16	84"	95-3/4"	16"
WCHARS89X13	89"	98-3/8"	13"
WCHARS97X17	97"	108-3/4"	17"
WCHARS101X13	101"	110"	13"
WCHARS108X19	108"	119-7/8"	19-1/4"

\*Bottom trim adds 1" to overall height.

Part Number Logic:

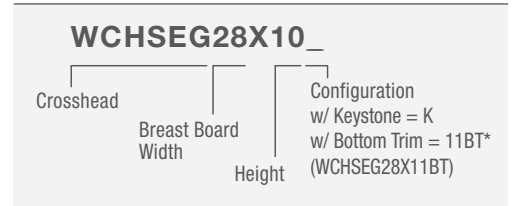

# 10" Eyebrow Crosshead

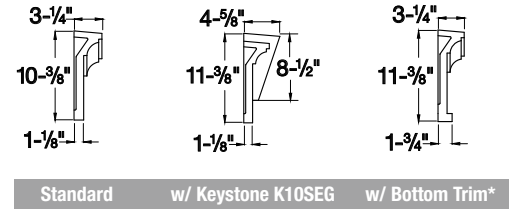
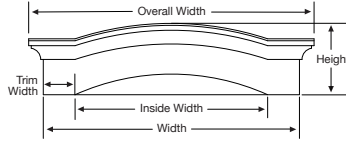

Part Number	Width	Inside Width	Overall Width
WCHSEG28X10	37-1/4"	28"	41-1/2"
WCHSEG30X10	39-1/8"	29-7/8"	43-3/8"
WCHSEG34X10	44"	34"	48-1/4"
WCHSEG36X10	45"	36"	49-1/4"
WCHSEG43X10	48"	43"	52-1/4"
WCHSEG44X10	49"	44"	53-1/4"
WCHSEG64X10	73-1/4"	64"	77-1/2"
WCHSEG72X10	81"	72"	85-1/4"

# Large Door Crosshead

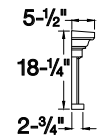
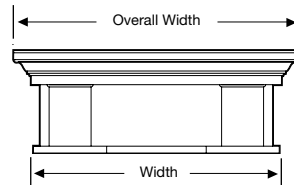

Standard

Part Number	Width	Overall Width	Pediment	Pilaster
LDCH58X18	58"	67-1/2"	AP667, PCP667, RHP667, SP667	All 11" Pilasters
LDCH62X18	62"	71-1/2"	AP667, PCP667, RHP667, SP667	
LDCH87X18	87"	96-1/2"	—	
LDCH90X18	90-1/2"	100"	RHP6100	
LDCH94X18	94-1/2"	104"	RHP6100	

Parts may be required to ship LTL (less than truckload) based on size and overall dimensions.

# Half-Round Spoked Pediment

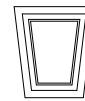
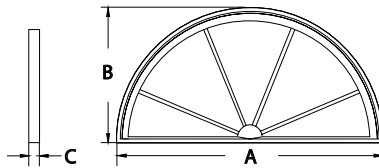

Keystone  
KWM180M Page 55

Part Number	Width (A)	Height (B)	Projection (C)	Flat Trim	Decorative Trim
HRSP36X18	36"	18"	1-3/4"	AR36X4F AR36X6F	AR36X4M, AR36X6M AR36X10MC
HRSP48X24	48"	24"	1-3/4"	AR48X4F AR48X6F	AR48X4M, AR48X6M
HRSP72X36	72"	36"	1-3/4"	AR72X4F	AR72X6M

# Segment Sunburst

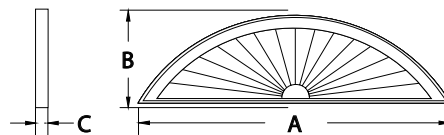

Keystone  
KWM180M Page 55

Part Number	Width (A)	Height (B)	Projection (C)
SWDH36X9	36"	9"	1-3/4"
SWDH40X10	40"	10"	1-3/4"
SWDH48X13	48"	13"	1-3/4"
SWDH68X14	67-5/8"	14"	1-3/4"
SWDH72X14	72"	14"	1-3/4"
SWDH76X15	76"	15"	1-3/4"
SWDH80X15	79-1/2"	15"	1-3/4"

# Elliptical Sunburst

with Decorative Trim

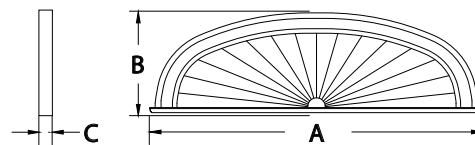

Part Number	Width (A)	Height (B)	Projection (C)
ESWDH76X23	76-7/8"	23"	3-1/2"



## Half-Round Sunburst

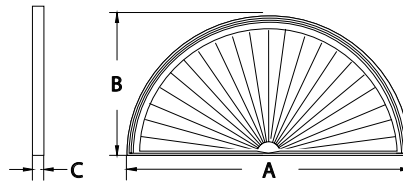

Keystone  
KWM180M Page 55

Part Number	Width (A)	Height (B)	Projection (C)	Flat Trim	Decorative Trim
SWDH24X12	24"	12"	1-3/4"	AR24X4F	—
SWDH28X14	28"	14"	1-3/4"	—	—
SWDH30X15	30"	15"	1-3/4"	—	—
SWDH32X16	32"	16"	1-3/4"	—	—
SWDH33X17	33-5/8"	16-3/4"	1-3/4"	—	—
SWDH36X18	36"	18"	1-3/4"	AR36X4F AR36X6F	AR36X4M, AR36X6M AR36X10MC
SWDH37X19	37-5/8"	18-3/4"	1-3/4"	AR37X4F	—
SWDH40X20	40"	20"	1-3/4"	—	AR40X6M DVP40
SWDH42X21	42"	21"	1-3/4"	—	—
SWDH44X22	44"	22"	1-3/4"	—	—
SWDH48X24	48"	24"	1-3/4"	AR48X4F AR48X6F	AR48X4M, AR48X6M
SWDH56X28	56"	28"	1-3/4"	—	—
SWDH60X30	60"	30"	1-3/4"	—	AR60X6M
SWDH64X32	64"	32"	1-3/4"	—	AR64X10MC
SWDH68X34	68"	34"	1-3/4"	—	—
SWDH72X36	72"	36"	1-3/4"	AR72X4F	AR72X6M
SWDH76X38	76"	38"	1-3/4"	—	—
SWDH100X50	100"	50"	1-3/4"	—	—

# Half-Round Sunburst

with Flat Trim & Keystone

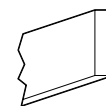
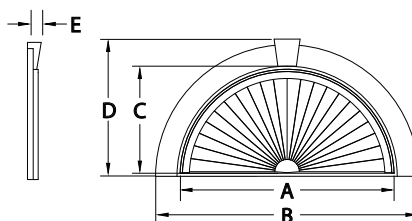

Flat Trim  
FLT152

Part Number	Width (A)	Overall Width (B)	Height (C)	Overall Height (D)	Projection (E)
SWDH36X18-4FK	36"	43"	18"	22-1/2"	2-1/4"

# Sunburst Pediment

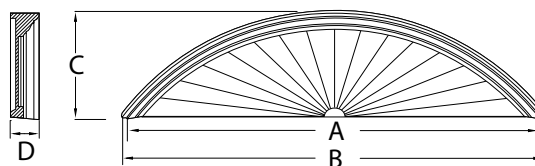

Part Number	Width (A)	Overall Width (B)	Height (C)	Projection (D)	Crosshead
SP56	55-1/4"	57"	16-3/4"	4-1/2"	WCH50X9
SP667	66-3/4"	69-1/4"	20-3/8"	5-1/2"	LDCH58X18 LDCH62X18
SP86	85-5/8"	87-1/4"	22-1/2"	4-1/2"	WCH81X9
SP91	90-1/2"	92-1/2"	26"	4-1/2"	WCH86X9

## Combination Sunburst Pediment

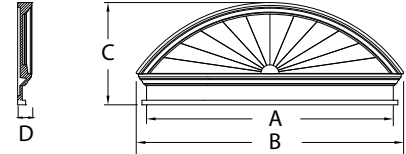
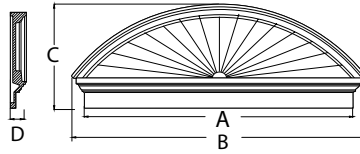

Part Number	Width (A)	Overall Width (B)	Height (C)	Projection (D)	Breast Board Thickness	Part Number w/ Bottom Trim*
CSP54	54"	58-1/2"	21-3/8"	3-1/8"	1"	CSP54BT
CSP75	75"	79-5/8"	23-3/4"	3-1/8"	1"	CSP75BT
CSP80	80"	84-5/8"	25-1/2"	3-1/8"	1"	CSP80BT
CSP85	85"	89-1/2"	26-3/8"	3-1/8"	1"	CSP85BT

## Combination Segment Arch Pediment

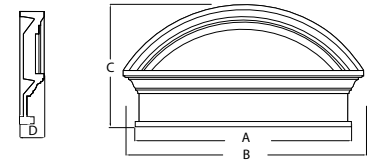
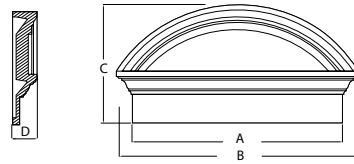

Part Number	Width (A)	Overall Width (B)	Height (C)	Projection (D)	Part Number w/ Bottom Trim*
CSAP36	36"	41-1/2"	20"	4-1/2"	CSAP36BT
CSAP48	48"	53-1/2"	22-1/2"	4-1/2"	CSAP48BT
CSAP65	65"	70-1/2"	28-3/8"	4-1/2"	CSAP65BT
CSAP84	84"	89-1/2"	28"	4-1/2"	CSAP84BT

\*Bottom trim adds 1" to overall height.

Parts may be required to ship LTL (less than truckload) based on size and overall dimensions.

## Peaked Cap Pediment

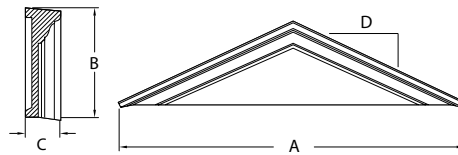

Part Number	Overall Width (A)	Overall Height (B)	Projection (C)	Pitch (D)	Crosshead
PCP56	56-1/2"	13-5/8"	4-1/2"	5-1/2 / 12	WCH50X9
PCP667	68-3/4"	23-5/8"	5-1/2"	8 / 12	LDCH58X18 LDCH62X18

## Combination Peaked Cap Pediment

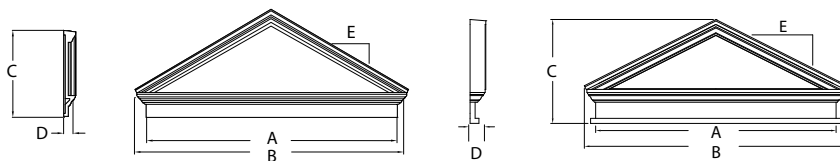

Part Number	Width (A)	Overall Width (B)	Overall Height (C)	Projection (D)	Pitch (E)	Breast Board Thickness	Part Number w/ Bottom Trim*
CPCP48	47-1/2"	52"	19-1/2"	3-1/8"	6 / 12	1"	CPCP48BT
CPCP50	50"	54-1/2"	20-1/4"	3-1/8"	6 / 12	1"	CPCP50BT
CPCP54	54"	58-1/4"	21"	3-1/8"	6 / 12	1"	CPCP54BT
CPCP58	58"	62-3/8"	22"	3-1/8"	6 / 12	1"	CPCP58BT
CPCP67	67-1/2"	72"	24-1/2"	3-1/8"	6 / 12	1"	CPCP67BT
CPCP75	75"	79-1/2"	26-1/4"	3-1/8"	6 / 12	1"	CPCP75BT
CPCP80	80"	84-1/2"	27-5/8"	3-1/8"	6 / 12	1"	CPCP80BT
CPCP85	85"	89-1/2"	28-3/4"	3-1/8"	6 / 12	1"	CPCP85BT





## Combination Peaked Cap Pediment

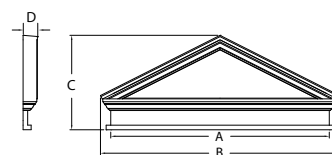
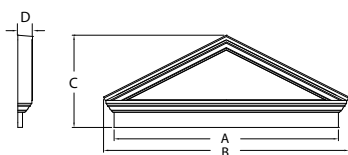

Part Number	Width (A)	Overall Width (B)	Height (C)	Projection (D)	Part Number w/ Bottom Trim*
CCP37	37 <sup>-5/8</sup> "	41 <sup>-3/4</sup> "	20 <sup>-1/2</sup> "	4 <sup>-1/2</sup> "	CCP37BT

\*Bottom trim adds 1" to overall height.

Parts may be required to ship LTL (less than truckload) based on size and overall dimensions.

# Acorn Pediment



Note: Acorn ships unattached in carton.

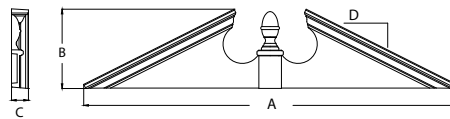

Part Number	Overall Width (A)	Overall Height (B)	Projection (C)	Pitch (D)	Crosshead
AP56	57"	16- <sup>5</sup> / <sub>8</sub> "	4- <sup>1</sup> / <sub>2</sub> "	6- <sup>1</sup> / <sub>2</sub> / 12	WCH50X9
AP61	62"	16- <sup>3</sup> / <sub>4</sub> "	4- <sup>1</sup> / <sub>2</sub> "	7 / 12	WCH54X9 WCH56X9
AP667	68- <sup>7</sup> / <sub>8</sub> "	23- <sup>1</sup> / <sub>4</sub> "	5- <sup>1</sup> / <sub>2</sub> "	12 / 12	LDCH58X18 LDCH62X18
AP86	87- <sup>1</sup> / <sub>4</sub> "	24"	4- <sup>1</sup> / <sub>2</sub> "	7 / 12	WCH81X9
AP91	92- <sup>1</sup> / <sub>8</sub> "	24- <sup>1</sup> / <sub>2</sub> "	4- <sup>1</sup> / <sub>2</sub> "	6 / 12	WCH86X9
AP98	99- <sup>1</sup> / <sub>8</sub> "	24- <sup>1</sup> / <sub>2</sub> "	4- <sup>1</sup> / <sub>2</sub> "	6 / 12	WCH90X9 WCH93X9

# Acorn Pediment

Adjustable



Note: Ships in 4 pieces.

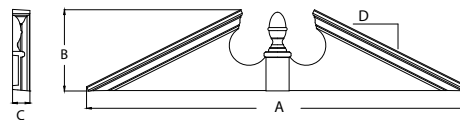

Part Number	Overall Width (A)	Overall Height (B)	Projection (C)	Pitch (D)	Crosshead
AP115	105"-115"	25- <sup>5</sup> / <sub>8</sub> "	4- <sup>1</sup> / <sub>2</sub> "	6 / 12	9" WCH from 100"-110"

# Combination Acorn Pediment



Note: Acorn ships unattached in carton.

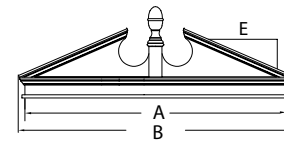
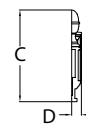
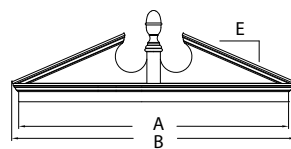
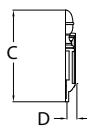

Part Number	Width (A)	Overall Width (B)	Overall Height (C)	Projection (D)	Pitch (E)	Part Number w/ Bottom Trim*
CAP47E**	47"	50- <sup>1</sup> / <sub>8</sub> "	13- <sup>5</sup> / <sub>8</sub> "	2- <sup>1</sup> / <sub>8</sub> "	5 / 12	—
CAP50	50"	54- <sup>1</sup> / <sub>2</sub> "	21- <sup>1</sup> / <sub>8</sub> "	3- <sup>1</sup> / <sub>8</sub> "	6 / 12	CAP50BT
CAP54	54"	58- <sup>1</sup> / <sub>2</sub> "	21- <sup>3</sup> / <sub>8</sub> "	3- <sup>1</sup> / <sub>8</sub> "	6 / 12	CAP54BT
CAP58	58"	62- <sup>1</sup> / <sub>2</sub> "	21- <sup>3</sup> / <sub>4</sub> "	3- <sup>1</sup> / <sub>8</sub> "	6 / 12	CAP58BT
CAP67	67- <sup>1</sup> / <sub>2</sub> "	72"	24- <sup>1</sup> / <sub>8</sub> "	3"	6 / 12	CAP67BT
CAP75	75"	79- <sup>1</sup> / <sub>2</sub> "	25- <sup>1</sup> / <sub>8</sub> "	3- <sup>1</sup> / <sub>8</sub> "	6 / 12	CAP75BT
CAP80	80"	84- <sup>7</sup> / <sub>16</sub> "	25- <sup>3</sup> / <sub>8</sub> "	3- <sup>1</sup> / <sub>8</sub> "	5- <sup>1</sup> / <sub>2</sub> / 12	CAP80BT
CAP85	85"	89- <sup>3</sup> / <sub>8</sub> "	28- <sup>3</sup> / <sub>4</sub> "	3- <sup>1</sup> / <sub>8</sub> "	5 / 12	CAP85BT

\*Bottom trim adds 1" to overall height.

\*\*Does not have breast board. Accessories cannot be added.

# Rams Head Pediment



Note: Urn ships unattached in carton.

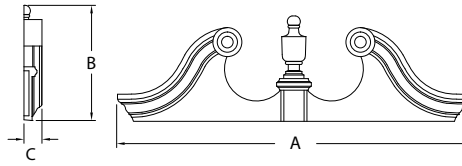

Part Number	Overall Width (A)	Overall Height (B)	Projection (C)	Crosshead
RHP56	60-7/8"	19-1/8"	4-1/2"	WCH50X9
RHP86	93-1/4"	29-1/2"	4-1/2"	WCH81X9

# Rams Head Pediment

with Decorative Trim

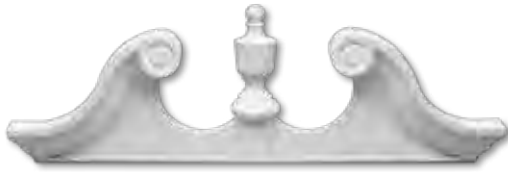

Note: Urn ships unattached in carton.

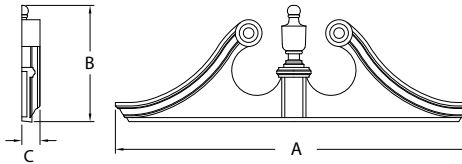

Part Number	Overall Width (A)	Overall Height (B)	Projection (C)	Crosshead
RHP667	73-1/2"	21-1/2"	5-1/2"	LDCH58X18 LDCH62X18
RHP6100	107-1/4"	29-3/8"	5-1/2"	LDCH90X18 LDCH94X18

# Combination Rams Head Pediment



Note: Urn ships unattached in carton.

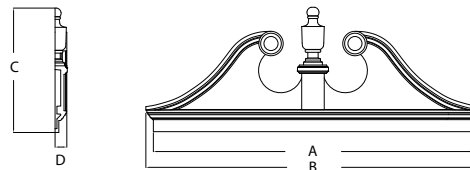

Part Number	Width (A)	Overall Width (B)	Overall Height (C)	Projection (D)	Breast Board Thickness	Part Number w/ Bottom Trim*
CRHP54	54"	58"	23-1/2"	3-1/8"	1"	CRHP54BT
CRHP67	67-1/2"	71-1/2"	27"	3-1/8"	1"	CRHP67BT
CRHP75	75"	79"	29-1/8"	3-1/8"	1"	CRHP75BT
CRHP80	80"	84"	35-3/4"	3-1/8"	1"	CRHP80BT
CRHP85	85"	89"	33-5/8"	3-1/8"	1"	CRHP85BT



## Deluxe Victorian Pediment



Part Number	Inside Width (A)	Inside Height	Overall Width (B)	Radius	Pitch (C)	Accessories
DVP40	40"	24-1/2"	67-1/4"	20"	7 / 12	PIL8X90P, PIL8X108P SWDH40X20

## 7" Panel Arch

with Sunburst & Keystone

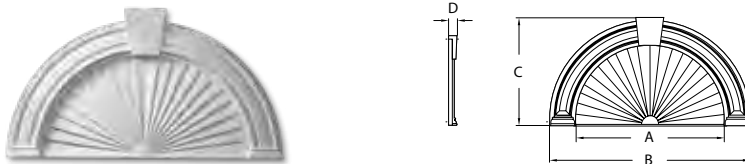

Part Number	Sunburst Width (A)	Overall Width (B)	Height (C)	Radius	Keystone Projection (D)	Pilaster
AR40X54PSK	40"	54"	29"	20"	2-5/8"	PIL7X90DP

Note: PIL7X90DP matches this arch profile only.

## 10" Decorative Arch

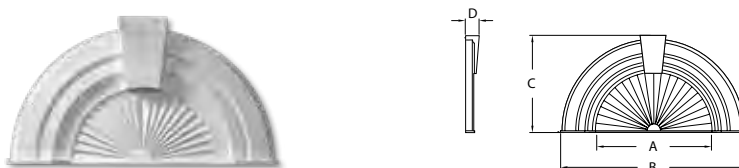

Part Number	Sunburst Width (A)	Overall Width (B)	Height (C)	Radius	Keystone Projection (D)	Pilaster
AR36X10SK	36"	56"	30-1/8"	2-1/8"	4"	PIL10X96A PIL10X192A

Note: This arch matches PIL10X96A and PIL10X192A only.

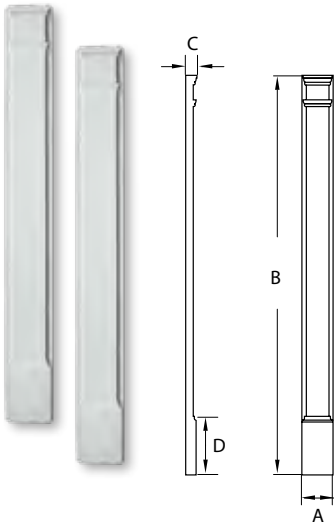

# Plain Pilaster

Molded with Plinth

Part Number	Width (A)	Height (B)	Projection (C)	Plinth Block Height (D)
PIL5X90P*	5-1/4"	90"	1-5/8"	10-1/8"
PIL6X90P*	6"	90"	2-1/2"	13-1/4"
PIL7X90P*	7"	90"	2-1/2"	13-1/4"
PIL8X90P*	8"	90"	2-1/2"	13-1/4"
PIL9X90P*	9"	90"	3"	14-1/2"
PIL11X90P*	11"	90"	3-1/2"	13-1/4"

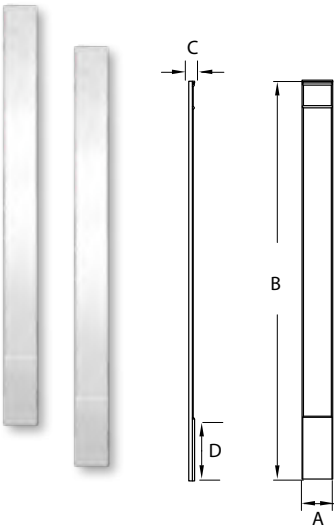

# Plain Narrow Pilaster

Molded with Plinth

Part Number	Width (A)	Height (B)	Projection (C)	Plinth Block Height (D)
PIL7X90PE*	7"	90"	1-1/4"	14-1/4"



\*Sold as a set. Pilaster may be routed for J-Channel.  
Parts may be required to ship LTL (less than truckload) based on size and overall dimensions.

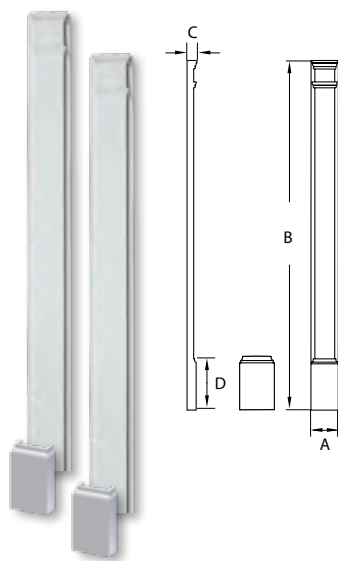

## Plain Pilaster

Two-Piece Adjustable

Part Number	Width (A)	Height (B)	Projection (C)	Plinth Block Height (D)
PIL5X108P*	5-1/4"	108"	1-5/8"	10"
PIL6X120P*	6"	120"	2-1/2"	13-1/4"
PIL7X108P*	7"	108"	2-1/2"	13"
PIL7X120P*	7"	120"	2-1/2"	13"
PIL8X108P*	8"	108"	2-5/8"	13"
PIL9X108P*	9"	108"	3"	14-1/2"
PIL9X120P*	9"	120"	3"	14-1/2"
PIL10X120P*	10"	120"	3-1/4"	14-1/2"
PIL11X96P*	11"	96"	3-1/2"	14-1/2"
PIL11X108P*	11"	108"	3-1/2"	14-1/2"
PIL11X109P*	11"	109"	3-1/2"	14-1/2"
PIL11X120P*	11"	120"	3-1/2"	14-1/2"

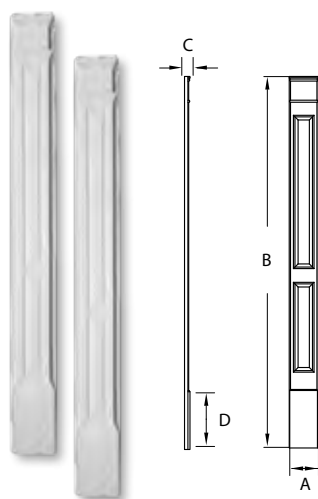

## Double Panel Pilaster

Molded with Plinth

Part Number	Width (A)	Height (B)	Projection (C)	Plinth Block Height (D)
PIL5X90DP*	5-1/4"	90"	1-5/8"	10-1/8"
PIL7X90DP*	7"	90"	2-1/2"	13-1/4"
PIL9X90DP*	9"	90"	3"	14-1/2"
PIL9X100DP*	9"	100"	3"	14-1/2"
PIL11X90DP*	11"	90"	3-1/2"	14-1/2"
PIL11X108DP*	11"	108"	3-1/2"	14-1/2"

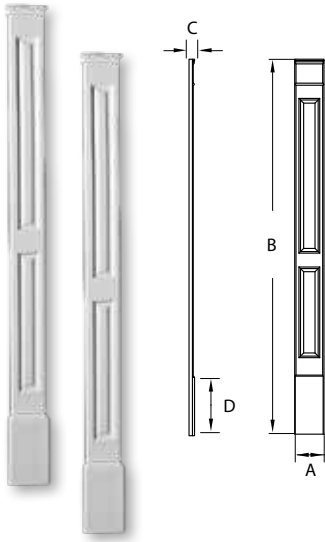

## Double Panel Narrow Pilaster

Molded with Plinth

Part Number	Width (A)	Height (B)	Projection (C)	Plinth Block Height (D)
PIL7X90DPE*	7"	90"	1-1/4"	14-1/4"

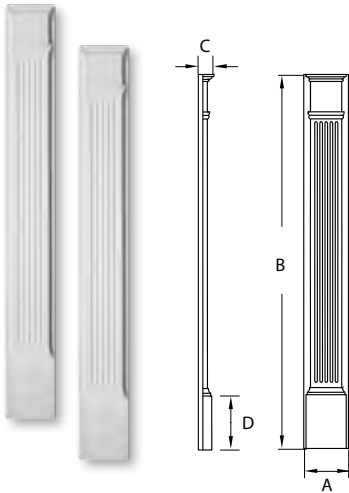

## Fluted Pilaster

Molded with Plinth

Part Number	Width (A)	Height (B)	Projection (C)	Plinth Block Height (D)
PIL3X81*	3-1/2"	81"	1-5/8"	10"
PIL4X83*	4-1/2"	82-3/4"	1-5/8"	7-3/4"
PIL4X86*	4-1/2"	86"	1-5/8"	11"
PIL4X90*	4-1/2"	90"	1-5/8"	10"
PIL5X82*	5-1/4"	82"	1-3/4"	8"
PIL5X90*	5-1/4"	90"	1-3/4"	10-1/8"
PIL6X90*	6-1/4"	90"	2-1/2"	13-1/4"
PIL7X90*	7"	90"	2-1/2"	13-1/4"
PIL9X90*	9"	90"	3"	14-1/2"
PIL11X90*	11"	90"	3-1/2"	14-1/2"

\*Sold as a set. Pilaster may be routed for J-Channel.

Parts may be required to ship LTL (less than truckload) based on size and overall dimensions.

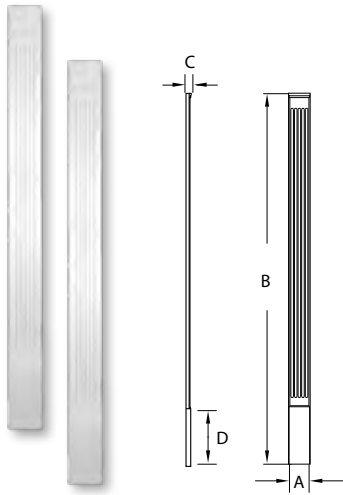

## Fluted Narrow Pilaster

Molded with Plinth

Part Number	Width (A)	Height (B)	Projection (C)	Plinth Block Height (D)
PIL3X90E*	3"	90"	1-1/4"	14-1/4"
PIL5X90E*	5-1/4"	90"	1-1/4"	14-1/4"
PIL7X90E*	7"	90"	1-1/4"	14-1/4"
PIL9X90E*	9"	90"	1-1/4"	14-1/4"

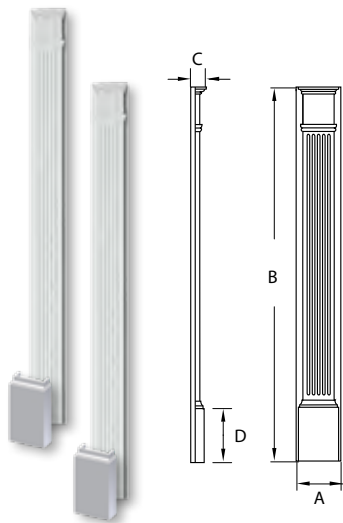

## Fluted Pilaster

Two-Piece Adjustable

Part Number	Width (A)	Height (B)	Projection (C)	Plinth Block Height (D)
PIL3X108*	3-1/2"	108"	1-5/8"	10"
PIL4X108*	4-1/2"	108"	1-5/8"	10"
PIL5X108*	5-1/4"	108"	1-5/8"	10"
PIL6X108*	6-1/4"	108"	2-1/2"	13-1/4"
PIL6X144*	6-1/4"	144"	2-1/2"	13-1/4"
PIL7X102*	7"	102"	2-1/2"	13-1/4"
PIL7X108*	7"	108"	2-1/2"	13"
PIL7X144*	7"	144"	2-1/2"	13"
PIL8X90*	8"	90"	2-1/2"	13"
PIL8X108*	8"	108"	2-1/2"	13"
PIL8X144*	8"	144"	2-1/2"	13"
PIL9X102*	9"	102"	3"	14-1/2"
PIL9X108*	9"	108"	3"	14-1/2"
PIL9X144*	9"	144"	3"	14-1/2"
PIL11X108*	11"	108"	3-1/2"	14-1/2"
PIL11X120*	11"	120"	3-1/2"	14-1/2"
PIL11X144*	11"	144"	3-1/2"	14-1/2"



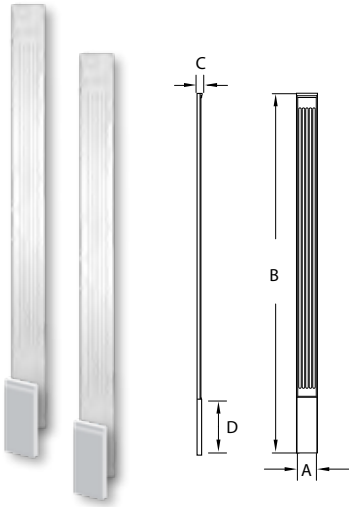

## Fluted Narrow Pilaster

Two-Piece Adjustable

Part Number	Width (A)	Height (B)	Projection (C)	Plinth Block Height (D)
PIL5X120E*	5-1/4"	120"	1-1/4"	14-1/4"
PIL7X120E*	7"	120"	1-1/4"	14-1/4"

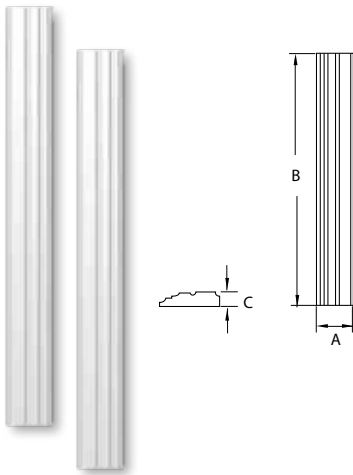

## Arch Profile Pilaster

Matches 10M Decorative Arches

Part Number	Width (A)	Height (B)	Projection (C)
PIL10X96A*	10"	96"	2-3/8"
PIL10X192A*	10"	192"	2-3/8"

Note: See page 44 for matching arches.

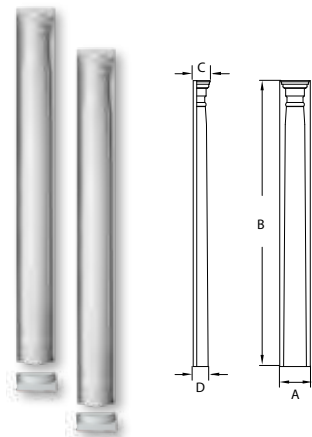

## Half-Round Pilaster

Adjustable Column

Part Number	Width (A)	Shaft Height** (B)	Top Projection (C)	Bottom Projection (D)
PIL10X96HC*	10"	93-5/8"	4-7/8"	5-1/2"

\*\*Overall height is adjustable from 80"-96". Shaft sits on top of plinth, which is 3" in height.

\*Sold as a set. Pilaster may be routed for J-Channel.  
Parts may be required to ship LTL (less than truckload) based on size and overall dimensions.

# Fluted Panel Trim

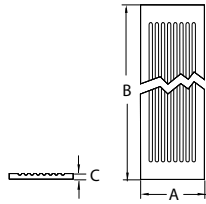

Part Number	Width (A)	Height (B)	Projection (C)
FP9X168*	8-1/2"	168"	1-1/4"
FP12X96	12"	96"	1-1/2"

\*Actual product has flutes running the full length on this size only.



# Half-Round Arch Trim

4F Flat

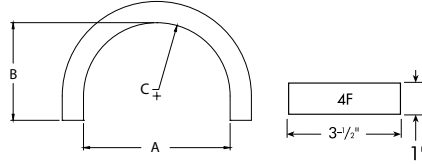

## Accessories

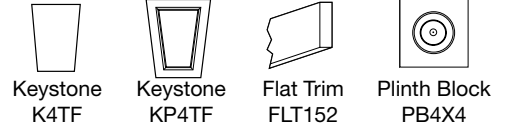

Part Number	Inside Width (A)	Inside Height (B)	Radius (C)
AR24X4F	24-1/8"	16-1/8"	12-1/8"
AR36X4F	36"	22"	18"
AR37X4F	37-5/8"	22-3/4"	18-3/4"
AR48X4F	48"	28"	24"
AR72X4F	72"	40"	36"

Note: This part uses keystones K4TF and KP4TF only.

# Half-Round Arch Trim

4M Decorative

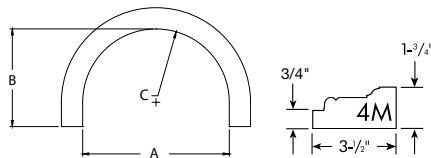

## Accessories



Part Number	Inside Width (A)	Inside Height (B)	Radius (C)
AR36X4M	36"	22"	18"
AR48X4M	48"	28"	24"

Note: This part uses keystones K4TM and KP4TM only.

# Half-Round Arch Trim

6F Flat

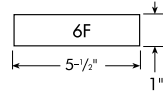
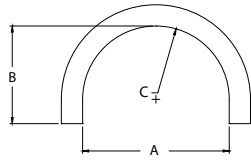

### Accessories

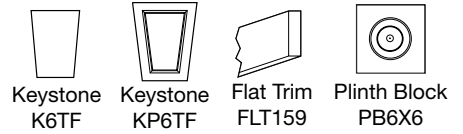

Part Number	Inside Width (A)	Inside Height (B)	Radius (C)
AR36X6F	36"	22"	18"
AR48X6F	48"	28"	24"

Note: This part uses keystones K6TF and KP6TF only.

# Half-Round Arch Trim

6M Decorative

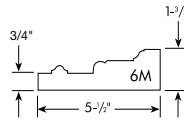
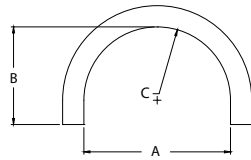

### Accessories



Part Number	Inside Width (A)	Inside Height (B)	Radius (C)
AR36X6M	36"	21"	18-1/8"
AR40X6M	40"	24"	20"
AR48X6M	48"	28"	24"
AR60X6M	60"	34"	30"
AR72X6M	72"	40"	36"

Note: This part uses keystones K6TM and KP6TM only.

# Half-Round Arch Trim

10M Decorative

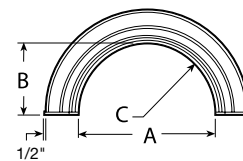
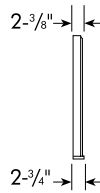

### Accessories

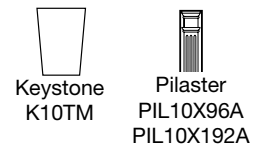

Part Number	Inside Width (A)	Inside Height (B)	Radius (C)
AR36X10MC	36"	18-3/4"	18"
AR64X10MC*	64"	32-3/4"	32"

\*Part ships in two pieces and will need to be trimmed in field to fit.

# Half-Round Arch with Flankers

10M Decorative

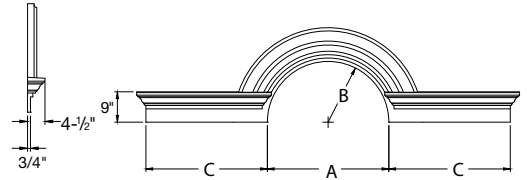

Part Number	Inside Width (A)	Inside Height / Radius (B)	Flanker Width (C)	Overall Width (D)	Accessories
AR36X10MFL108	36"	18"	36"	108"	K10TM SWDH36X18

# Circle Trim

4F Flat

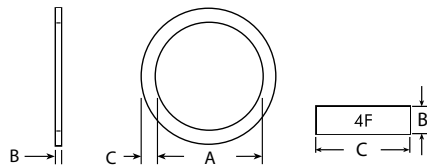

Part Number	Inside Width (A)	Projection (B)	Trim Width (C)
CIR24X4F	24-1/4"	1"	3-1/2"
CIR36X4F	36-1/8"	1"	3-1/2"

# Oval Trim

4F Flat

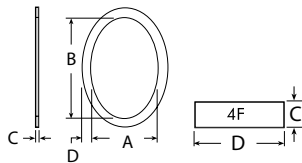

Part Number	Inside Width (A)	Inside Height (B)	Projection (C)	Trim Width (D)
OV24X36X4F	24-1/8"	36-1/8"	1"	3-1/2"

# Oval Trim

4M Decorative

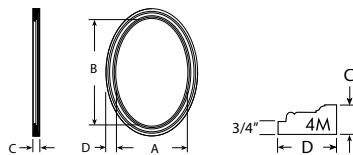

Part Number	Inside Width (A)	Inside Height (B)	Projection (C)	Trim Width (D)
OV24X36X4M	24-1/8"	36-1/8"	1-3/4"	3-1/2"

# Window Panel

Flat Panel

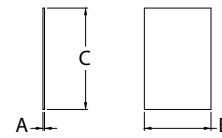

Part Number	Thickness (A)	Width (B)	Height (C)
FLT40X96*	1"	40"	96"
WDP48X73F	1-1/8"	48"	73"

\*Can also be found on page 87 under Flat Trim.

# Window Panel

Raised Panel

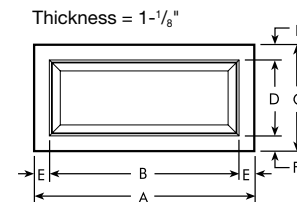

Part Number	Overall Width (A)	Panel Width (B)	Overall Height (C)	Panel Height (D)	Border Width (E)	Border Height (F)
WDP36X18	36"	28"	18"	10"	4"	4"

# Dormer Trim System











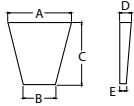
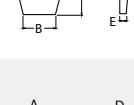

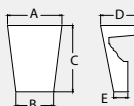
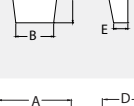
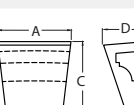

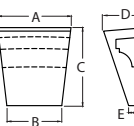

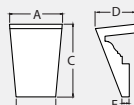

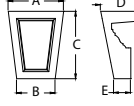
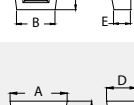

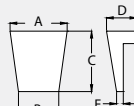
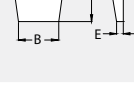
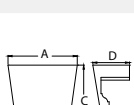
Dormer Trim System

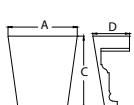
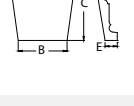
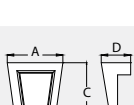
	Part Number	Width (A)	Overall Width (B)	Overall Height (C)	Projection (D)	Pitch (E)	
	DMP44 Pediment	43-3/4"	49-1/4"	33-1/4"	4-1/2"	14 / 12	
	DMST7X69 Side Trim Set	6-3/4"	—	68-5/8"	1-1/2"	—	
	DMR457-10 Return	—	—	—	—	—	

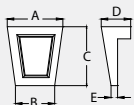
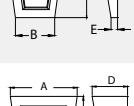
# Keystones

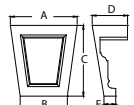
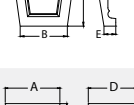
for Trim Profiles

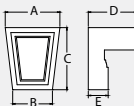
	Part Number	Top Width (A)	Bottom Width (B)	Height (C)	Top Projection (D)	Bottom Projection (E)	Arches & Trim	
	K6*	4-3/4"	2-3/4"	6-1/2"	2-1/4"	1-5/8"	—	
	K8*	9-3/4"	5-3/4"	7-3/4"	2-1/4"	1-1/4"	—	
	K6M	5-3/4"	4"	7"	3-7/8"	1-1/2"	6" WCH, 6" WCH w/ BT 6" CH, 6" CH w/ BT	
	K9M	8"	6"	11"	6-1/8"	1-1/8"	9" WCH, 9" WCH w/ BT 9" CH, 9" CH w/ BT	
	K12M	8-1/2"	6"	13"	5-3/4"	2-1/8"	12" WCH	
	K10SEG	8"	6"	8-1/2"	4-5/8"	3/4"	10" WCHSEG	
	KCCA10	8"	6"	11"	6"	1-1/8"	10" CCA	
	KP6M	5-3/4"	4"	7"	4-1/8"	1-3/4"	6" WCH, 6" WCH w/ BT 6" CH, 6" CH w/ BT	
	KP9M	8"	6"	11"	6-1/4"	1-5/8"	9" WCH, 9" WCH w/ BT 9" CH, 9" CH w/ BT	
	K4TF	4-1/4"	3"	4-1/2"	2-1/4"	1/2"	4F Arches FLT152	
	K6TF	6"	4"	7"	2-3/8"	5/8"	6F Arches FLT159	
	K8TF	7"	5"	8-7/8"	2-1/2"	3/4"	FLT162	
	K4TM	4-1/4"	3"	4-1/2"	2-1/4"	3/4"	4M Arches MLD215	
	K6TM	6"	4"	7"	2-3/8"	7/8"	6M Arches MLD220 DWH221	
	K10TM	8"	5-1/2"	11-1/2"	4"	1-3/4"	10M Arch Trim PIL10X96A PIL10X192A	
	KP4TF	4-1/4"	3"	4-1/2"	2-1/4"	1/2"	4F Arches FLT152	
	KP6TF	6"	4"	7"	2-3/8"	5/8"	6F Arches FLT159	
	KP4TM	4-1/4"	3"	4-1/2"	2-3/4"	3/4"	4M Arch Trim MLD215	
	KP6TM	6"	4"	7"	2-1/2"	7/8"	6M Arch Trim MLD220 DWH221	
	KWM180M	2-3/4"	2"	3-1/8"	2-1/2"	—	Brick Mould Louvers / Trim MLDWM180	

\*Keystones K6 and K8 are not molded on back side.  
Parts may be required to ship LTL (less than truckload) based on size and overall dimensions.

# Louvered Shutter

with Center Rail

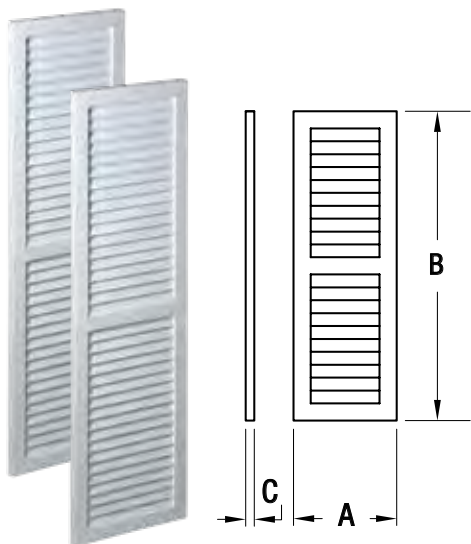

Part Number	Width (A)	Height (B)	Projection (C)
LVSH12X36FNCR	12"	36"	1"
LVSH12X48FNCR	12"	48"	1"
LVSH16X54FNCR	16"	54"	1"
LVSH16X60FNCR	16"	60"	1"
LVSH16X72FNCR	16"	72"	1"
LVSH18X60FNCR	18"	60"	1"
LVSH18X66FNCR	18"	66"	1"
LVSH18X72FNCR	18"	72"	1"
LVSH24X60FNCR	24"	60"	1"
LVSH24X72FNCR	24"	72"	1"

# Raised Panel Shutter

Double Panel

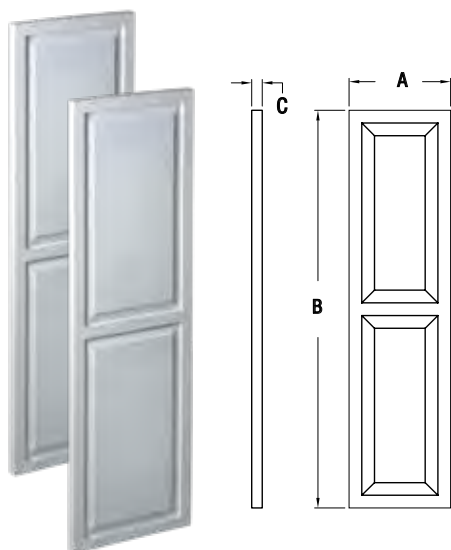

Part Number	Width (A)	Height (B)	Projection (C)
SH16X48DP	16"	48"	1-1/4"
SH16X54DP	16"	54"	1-1/4"
SH16X60DP	16"	60"	1-1/4"
SH16X65DP	16"	65"	1-1/4"
SH16X72DP	16"	72"	1-1/4"
SH18X53DP	18"	53"	1-1/4"
SH18X59DP	18"	59"	1-1/4"
SH18X66DP	18"	66"	1-1/4"
SH18X72DP	18"	72"	1-1/4"

Note: Shutters are sold as a set.

Parts may be required to ship LTL (less than truckload) based on size and overall dimensions.



# Louvered Shutter

without Center Rail

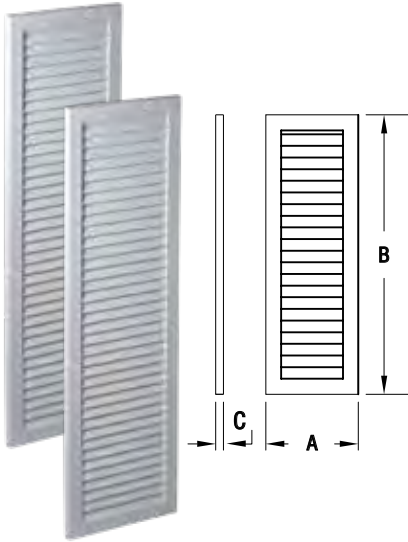

Part Number	Width (A)	Height (B)	Projection (C)
LVSH16X54FNB	16"	54"	1"
LVSH16X72FNB	16"	72"	1"
LVSH18X54FNB	18"	54"	1"
LVSH18X60FNB	18"	60"	1"
LVSH18X72FNB	18"	72"	1"
LVSH24X60FNB	24"	60"	1"
LVSH24X72FNB	24"	72"	1"



# Modern Farmhouse Shaker-Style Shutters

- Available in widths measuring 12", 16", 18" and 24", and heights measuring 24" - 120" in 1" increments.
- 2" wide stiles and 2-1/2" wide batten create the X-batten design.
- Stiles 1-3/8" deep with 5/8" recessed panel.
- Shaker-style shutter panels and flat trim are available to create your own farmhouse design, details on page 62.

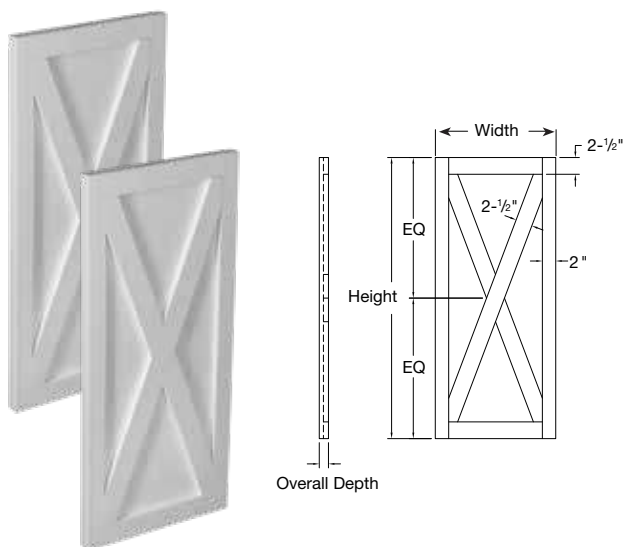

Part numbers shown reflect common sizes.  
For additional options, follow the part number logic below or contact your **Fypon®** representative.

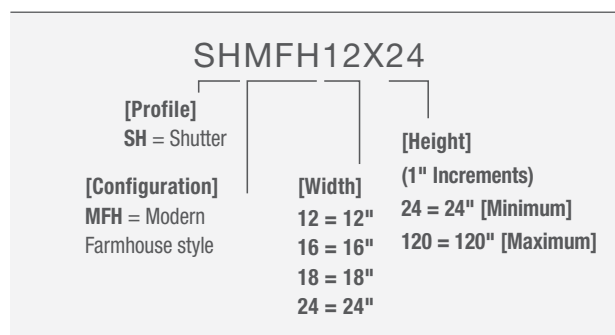

12"	16"	18"	24"
SHMFH12X24	SHMFH16X24	SHMFH18X24	SHMFH24X24
SHMFH12X36	SHMFH16X36	SHMFH18X36	SHMFH24X36
SHMFH12X48	SHMFH16X48	SHMFH18X48	SHMFH24X48
SHMFH12X60	SHMFH16X60	SHMFH18X60	SHMFH24X60
SHMFH12X72	SHMFH16X72	SHMFH18X72	SHMFH24X72
SHMFH12X84	SHMFH16X84	SHMFH18X84	SHMFH24X84
SHMFH12X96	SHMFH16X96	SHMFH18X96	SHMFH24X96
SHMFH12X108	SHMFH16X108	SHMFH18X108	SHMFH24X108
SHMFH12X120	SHMFH16X160	SHMFH18X180	SHMFH24X240





# Shaker-Style Shutters

- 2-flat panel recessed stile and rail design.
- Available in widths measuring 12", 16", 18" and 24", and heights measuring 24" - 120" in 1" increments.
- 2" wide stiles with 2-½" wide rails. Center rail is positioned in the center of the shutter.
- Stiles 1-<sup>3</sup>/<sub>8</sub>" deep with 5/8" recessed panel.
- Shaker-style shutter panels and flat trim are available to create your own Craftsman design, details on page 62.

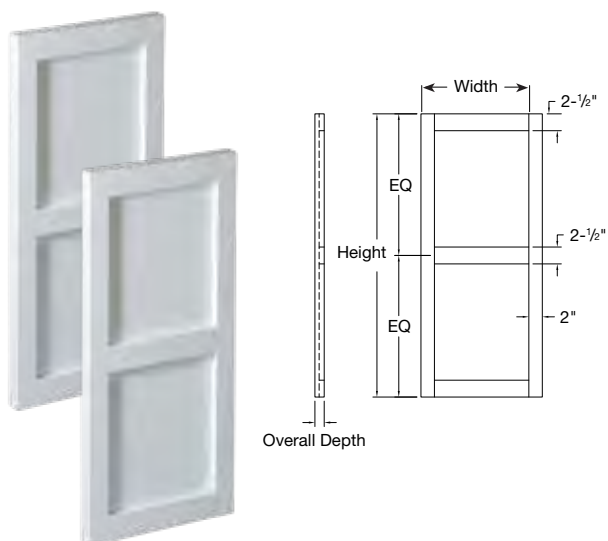

Part numbers shown reflect common sizes.  
For additional options, follow the part number logic below or contact your **Fypon®** representative.





SH2FP12X24			
[Profile]	[Width]	[Height]	
SH = Shutter	12 = 12"	(1" Increments)	
[Configuration]	16 = 16"	24 = 24" [Minimum]	
2FP = 2-Flat Panel	18 = 18"	120 = 120" [Maximum]	
	24 = 24"		

12"	16"	18"	24"
SH2FP12X24	SH2FP16X24	SH2FP18X24	SH2FP24X24
SH2FP12X36	SH2FP16X36	SH2FP18X36	SH2FP24X36
SH2FP12X48	SH2FP16X48	SH2FP18X48	SH2FP24X48
SH2FP12X60	SH2FP16X60	SH2FP18X60	SH2FP24X60
SH2FP12X72	SH2FP16X72	SH2FP18X72	SH2FP24X72
SH2FP12X84	SH2FP16X84	SH2FP18X84	SH2FP24X84
SH2FP12X96	SH2FP16X96	SH2FP18X96	SH2FP24X96
SH2FP12X108	SH2FP16X108	SH2FP18X108	SH2FP24X108
SH2FP12X120	SH2FP16X160	SH2FP18X180	SH2FP24X240

Note: Shutters are sold as a set.  
Parts may be required to ship LTL (less than truckload) based on size and overall dimensions.

# Shutter Board Fabrication Panels

For Shaker-style and Modern Farmhouse Shaker-style Shutters

	Individual Sheet Part Number	Width	Length	Thickness
	SHSFP12X144	12"	144"	1-3/8"
	SHSFP16X144	14"	144"	1-3/8"
	SHSFP18X144	18"	144"	1-3/8"
	SHSFP24X144	24"	144"	1-3/8"
	FLT1X3-12	2-1/2"	144"	3/4"



WOOD-GRAINED SHUTTERS





# Get the size and style you need.

- Our expanded line includes multiple styles and sizes, with widths measuring 12", 14", 18", and 24", and heights measuring 24"- 120" in 1" increments.
- Accessory line of hinges and clavos creates a distinct look for your shutters.
- Available in both Board & Batten and Plank styles.

## BOARD & BATTEN – JOINED BOARD AND BATTEN STYLES



**2 OR 3 BATTEN**  
Batten styles with joined boards.



**END BATTEN**  
Battens are placed at the very end of the boards.



**Z BATTEN**  
Horizontal and diagonal battens form Z shape.



**QUARTER ROUND**  
Mirrors unique arch top windows.



**ELLIPTICAL**  
Mirrors the shape of unique elliptical windows.

## PLANK – SPACED BOARDS CREATE VISIBILITY OF SIDING BETWEEN SHUTTER BOARDS



**2 OR 3 BATTEN**  
Batten styles with spaced boards.



**Z BATTEN**  
Horizontal and diagonal battens form Z shape.



**DIAMOND**  
Decorative diamond shape is centered between the panels.



**ELLIPTICAL**  
Mirrors the shape of unique elliptical windows.

### Board & Batten Part Number Logic:

### Plank Part Number Logic:

#### SH3PC18X60RS

#### SH3P018X60RS

**[Profile]**  
SH = Shutter

**[Profile]**  
SH = Shutter

**[Texture]**  
RS = Rough Sawn  
Stain or Paint

**[Texture]**  
RS = Rough Sawn  
Stain or Paint

**[Configuration]**

**[Configuration]**

2PC = 2-Board, 2-Batten    2PZC = 2-Board, Z-Batten  
3PC = 3-Board, 2-Batten    3PZC = 3-Board, Z-Batten  
4PC = 4-Board, 2-Batten    4PZC = 4-Board, Z-Batten  
  
2P3BC = 2-Board, 3-Batten    2PEBC = 2-Board, End Batten  
3P3BC = 3-Board, 3-Batten    3PEBC = 3-Board, End Batten  
4P3BC = 4-Board, 3-Batten    4PEBC = 4-Board, End Batten

2P0 = 2-Plank, 2-Batten    2PZ = 2-Plank, Z-Batten  
3P0 = 3-Plank, 2-Batten    3PZ = 3-Plank, Z-Batten  
4P0 = 4-Plank, 2-Batten    4PZ = 4-Plank, Z-Batten  
  
2P3B = 2-Plank, 3-Batten    2PD = 2-Plank, Diamond  
3P3B = 3-Plank, 3-Batten    3PD = 2-Plank, Diamond  
4P3B = 4-Plank, 3-Batten    4PD = 2-Plank, Diamond

**[Height]** (1" increments)  
24 = 24" [Minimum]  
120 = 120" [Maximum]

**[Width]**  
12 = 12"  
14 = 14"  
18 = 18"  
24 = 24"

**[Height]** (1" increments)  
24 = 24" [Minimum]  
120 = 120" [Maximum]

**[Width]**  
12 = 12"  
18 = 18"  
24 = 24"

### Quarter Round Part Number Logic:

#### SH3PHLR18X60RS

**[Profile]**  
SH = Shutter

**[Texture]**  
RS = Rough Sawn  
Stain or Paint

**[Configuration]**  
2PHLR = 2-Board Quarter  
3PHLR = 3-Board Quarter  
4PHLR = 4-Board Quarter

**[Height]** (1" increments)  
24 = 24" [Minimum]  
120 = 120" [Maximum]



**[Width]**  
12 = 12"  
14 = 14"  
18 = 18"  
24 = 24"

Note: Minimum height for Quarter Round shutters is double the width of the shutter.  
Example: SH3PHLR18x36RS – 18" = width of shutter and 36" = height (twice the width).



## 12" Board & Batten Shutters

Rough Sawn Cedar

2-Board, 2-Batten		2-Board, 3-Batten		2-Board, End Batten	
Part Number		Part Number		Part Number	
	SH2PC12X24RS		SH2P3BC12X24RS		SH2PEBC12X24RS
	SH2PC12X36RS		SH2P3BC12X36RS		SH2PEBC12X36RS
	SH2PC12X48RS		SH2P3BC12X48RS		SH2PEBC12X48RS
	SH2PC12X60RS		SH2P3BC12X60RS		SH2PEBC12X60RS
	SH2PC12X72RS		SH2P3BC12X72RS		SH2PEBC12X72RS
	SH2PC12X84RS		SH2P3BC12X84RS		SH2PEBC12X84RS
	SH2PC12X96RS		SH2P3BC12X96RS		SH2PEBC12X96RS
	SH2PC12X108RS		SH2P3BC12X108RS		SH2PEBC12X108RS
	SH2PC12X120RS		SH2P3BC12X120RS		SH2PEBC12X120RS

Note: Shutters are sold as a set.  
Parts may be required to ship LTL (less than truckload) based on size and overall dimensions.

Part numbers shown reflect common sizes. For additional options, follow the part number logic below or contact your Fypon® representative.

## SH2PC12X24RS

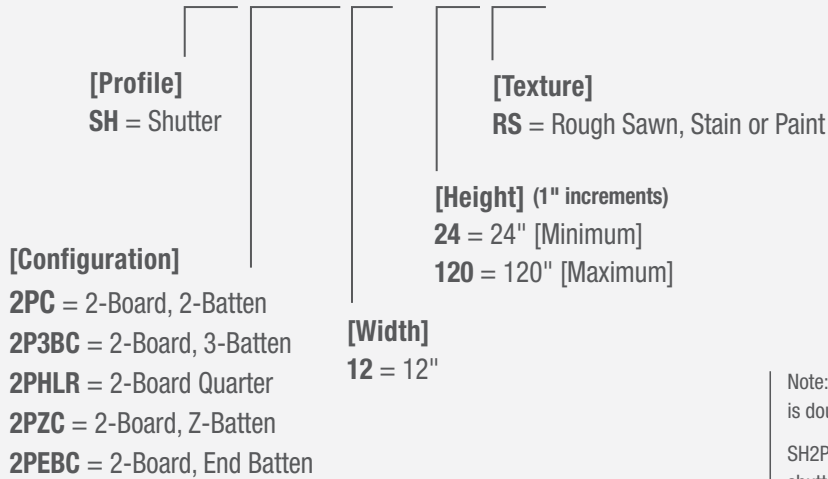

Note: Minimum height for Quarter Round shutters is double the width of the shutter.

SH2PHLR12X24RS - 12" = width of shutter and 24" = height (twice the width).

## 12" Board & Batten Shutters

Rough Sawn Cedar

2-Board, Z-Batten

2-Board, Quarter Round

Part Number

Part Number



SH2PZC12X24RS

SH2PZC12X36RS

SH2PZC12X48RS

SH2PZC12X60RS

SH2PZC12X72RS

SH2PZC12X84RS

SH2PZC12X96RS

SH2PZC12X108RS

SH2PZC12X120RS



SH2PHLR12X24RS

SH2PHLR12X36RS

SH2PHLR12X48RS

SH2PHLR12X60RS

SH2PHLR12X72RS

SH2PHLR12X84RS

SH2PHLR12X96RS

SH2PHLR12X108RS

SH2PHLR12X120RS



# 14" Board & Batten Shutters

Rough Sawn Cedar

3-Board, 2-Batten

Part Number

SH3PC14X24RS

SH3PC14X36RS

SH3PC14X48RS

SH3PC14X60RS

SH3PC14X72RS

SH3PC14X84RS

SH3PC14X96RS

SH3PC14X108RS

SH3PC14X120RS



3-Board, 3-Batten

Part Number

SH3P3BC14X24RS

SH3P3BC14X36RS

SH3P3BC14X48RS

SH3P3BC14X60RS

SH3P3BC14X72RS

SH3P3BC14X84RS

SH3P3BC14X96RS

SH3P3BC14X108RS

SH3P3BC14X120RS



3-Board, End Batten

Part Number

SH3PEBC14X24RS

SH3PEBC14X36RS

SH3PEBC14X48RS

SH3PEBC14X60RS

SH3PEBC14X72RS

SH3PEBC14X84RS

SH3PEBC14X96RS

SH3PEBC14X108RS

SH3PEBC14X120RS

Note: Shutters are sold as a set.  
Parts may be required to ship LTL (less than truckload) based on size and overall dimensions.

Part numbers shown reflect common sizes. For additional options, follow the part number logic below or contact your **Fypon®** representative.

## SH3PC14X24RS

**[Profile]**

**SH** = Shutter

**[Texture]**

**RS** = Rough Sawn, Stain or Paint

**[Configuration]**

**3PC** = 3-Board, 2-Batten

**3P3BC** = 3-Board, 3-Batten

**3PHLR** = 3-Board Quarter

**3PZC** = 3-Board, Z-Batten

**3PEBC** = 3-Board, End Batten

**[Height] (1" increments)**

**24** = 24" [Minimum]

**120** = 120" [Maximum]

**[Width]**

**14** = 14"

Note: Minimum height for Quarter Round shutters is double the width of the shutter.

Example: SH3PHLR14X28RS - 14" = width of shutter and 28" = height (twice the width).

## 14" Board & Batten Shutters

Rough Sawn Cedar

3-Board, Z-Batten

3-Board, Quarter Round

Part Number

Part Number



SH3PZC14X24RS

SH3PZC14X36RS

SH3PZC14X48RS

SH3PZC14X60RS

SH3PZC14X72RS

SH3PZC14X84RS

SH3PZC14X96RS

SH3PZC14X108RS

SH3PZC14X120RS



—

SH3PHLR14X36RS

SH3PHLR14X48RS

SH3PHLR14X60RS

SH3PHLR14X72RS

SH3PHLR14X84RS

SH3PHLR14X96RS

SH3PHLR14X108RS

SH3PHLR14X120RS



# 18" Board & Batten Shutters

Rough Sawn Cedar

3-Board, 2-Batten

Part Number

SH3PC18X24RS

SH3PC18X36RS

SH3PC18X48RS

SH3PC18X60RS

SH3PC18X72RS

SH3PC18X84RS

SH3PC18X96RS

SH3PC18X108RS

SH3PC18X120RS



3-Board, 3-Batten

Part Number

SH3P3BC18X24RS

SH3P3BC18X36RS

SH3P3BC18X48RS

SH3P3BC18X60RS

SH3P3BC18X72RS

SH3P3BC18X84RS

SH3P3BC18X96RS

SH3P3BC18X108RS

SH3P3BC18X120RS



3-Board, End Batten

Part Number

SH3PEBC18X24RS

SH3PEBC18X36RS

SH3PEBC18X48RS

SH3PEBC18X60RS

SH3PEBC18X72RS

SH3PEBC18X84RS

SH3PEBC18X96RS

SH3PEBC18X108RS

SH3PEBC18X120RS

Note: Shutters are sold as a set.  
Parts may be required to ship LTL (less than truckload) based on size and overall dimensions.

Part numbers shown reflect common sizes. For additional options, follow the part number logic below or contact your Fypon® representative.

## SH3PC18X24RS

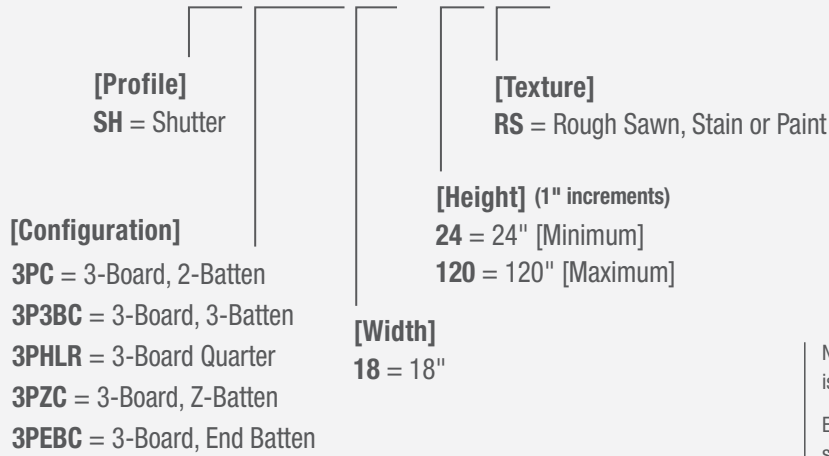

Note: Minimum height for Quarter Round shutters is double the width of the shutter.

Example: SH3PHLR18x36RS – 18" = width of shutter and 36" = height (twice the width).

3-Board, Z-Batten

3-Board, Quarter Round

	Part Number		Part Number
	SH3PZC18X24RS		—
	SH3PZC18X36RS		SH3PHLR18X36RS
	SH3PZC18X48RS		SH3PHLR18X48RS
	SH3PZC18X60RS		SH3PHLR18X60RS
	SH3PZC18X72RS		SH3PHLR18X72RS
	SH3PZC18X84RS		SH3PHLR18X84RS
	SH3PZC18X96RS		SH3PHLR18X96RS
	SH3PZC18X108RS		SH3PHLR18X120RS
SH3PZC18X120RS	SH3PHLR18X120RS		



## 24" Board & Batten Shutters

Rough Sawn Cedar

4-Board, 2-Batten

4-Board, 3-Batten

4-Board, End Batten

4-Board, 2-Batten		4-Board, 3-Batten		4-Board, End Batten	
Part Number		Part Number		Part Number	
	SH4PC24X24RS		SH4P3BC24X24RS		SH4PEBC24X24RS
	SH4PC24X36RS		SH4P3BC24X36RS		SH4PEBC24X36RS
	SH4PC24X48RS		SH4P3BC24X48RS		SH4PEBC24X48RS
	SH4PC24X60RS		SH4P3BC24X60RS		SH4PEBC24X60RS
	SH4PC24X72RS		SH4P3BC24X72RS		SH4PEBC24X72RS
	SH4PC24X84RS		SH4P3BC24X84RS		SH4PEBC24X84RS
	SH4PC24X96RS		SH4P3BC24X96RS		SH4PEBC24X96RS
	SH4PC24X108RS		SH4P3BC24X108RS		SH4PEBC24X108RS
	SH4PC24X120RS		SH4P3BC24X120RS		SH4PEBC24X120RS

Note: Shutters are sold as a set.  
Parts may be required to ship LTL (less than truckload) based on size and overall dimensions.



Part numbers shown reflect common sizes. For additional options, follow the part number logic below or contact your **Fypon®** representative.

## SH4PC24X24RS

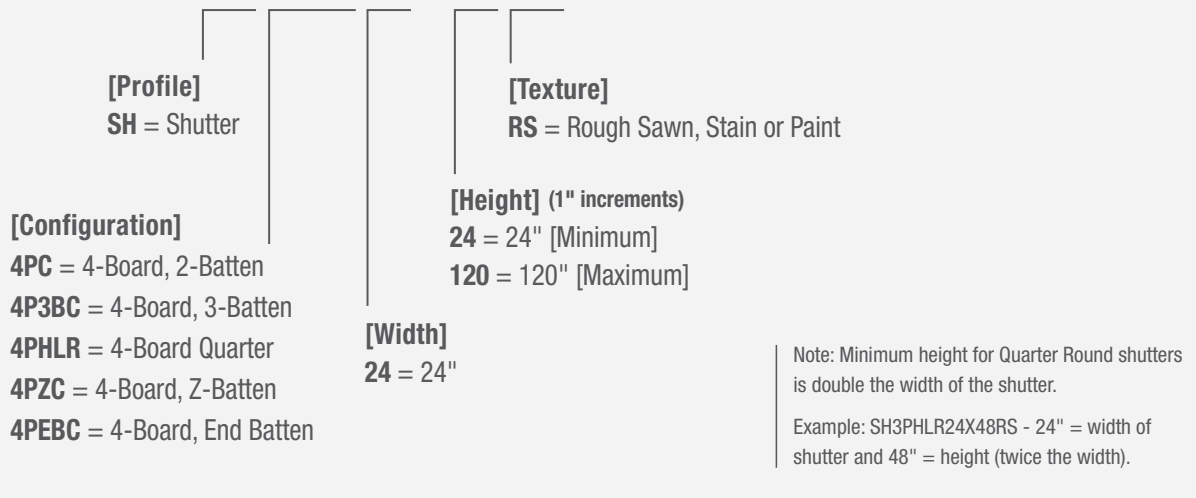

	4-Board, Z-Batten		4-Board, Quarter Round
	Part Number		Part Number
	SH4PZC24X24RS		—
	SH4PZC24X36RS		—
	SH4PZC24X48RS		SH4PHLR24X48RS
	SH4PZC24X60RS		SH4PHLR24X60RS
	SH4PZC24X72RS		SH4PHLR24X72RS
	SH4PZC24X84RS		SH4PHLR24X84RS
	SH4PZC24X96RS		SH4PHLR24X96RS
	SH4PZC24X108RS		SH4PHLR24X108RS
	SH4PZC24X120RS		SH4PHLR24X120RS



# 12" Plank Shutters

Rough Sawn Cedar

2-Plank, 2-Batten

2-Plank, 3-Batten

2-Plank, Z-Batten

2-Plank, 2-Batten		2-Plank, 3-Batten		2-Plank, Z-Batten	
Image	Part Number	Image	Part Number	Image	Part Number
	SH2P012X24RS		SH2P3B12X24RS		SH2PZ12X24RS
	SH2P012X36RS		SH2P3B12X36RS		SH2PZ12X36RS
	SH2P012X48RS		SH2P3B12X48RS		SH2PZ12X48RS
	SH2P012X60RS		SH2P3B12X60RS		SH2PZ12X60RS
	SH2P012X72RS		SH2P3B12X72RS		SH2PZ12X72RS
	SH2P012X84RS		SH2P3B12X84RS		SH2PZ12X84RS
	SH2P012X96RS		SH2P3B12X96RS		SH2PZ12X96RS
	SH2P012X108RS		SH2P3B12X108RS		SH2PZ12X108RS
	SH2P012X120RS		SH2P3B12X120RS		SH2PZ12X120RS

# 18" Plank Shutters

Rough Sawn Cedar

3-Plank, 2-Batten

3-Plank, 3-Batten

3-Plank, Z-Batten

3-Plank, 2-Batten		3-Plank, 3-Batten		3-Plank, Z-Batten	
Image	Part Number	Image	Part Number	Image	Part Number
	SH3P018X24RS		SH3P3B18X24RS		SH3PZ18X24RS
	SH3P018X36RS		SH3P3B18X36RS		SH3PZ18X36RS
	SH3P018X48RS		SH3P3B18X48RS		SH3PZ18X48RS
	SH3P018X60RS		SH3P3B18X60RS		SH3PZ18X60RS
	SH3P018X72RS		SH3P3B18X72RS		SH3PZ18X72RS
	SH3P018X84RS		SH3P3B18X84RS		SH3PZ18X84RS
	SH3P018X96RS		SH3P3B18X96RS		SH3PZ18X96RS
	SH3P018X108RS		SH3P3B18X108RS		SH3PZ18X108RS
	SH3P018X120RS		SH3P3B18X120RS		SH3PZ18X120RS

Note: Shutters are sold as a set.

Parts may be required to ship LTL (less than truckload) based on size and overall dimensions.

Part numbers shown reflect common sizes. For additional options, follow the part number logic below or contact your **Fypon®** representative.

## SH2PO12X24RS

<p><b>[Profile]</b> SH = Shutter</p>	<p><b>[Texture]</b> RS = Rough Sawn Stain or Paint</p>				
<p><b>[Configuration]</b></p> <table style="width: 100%; border: none;"> <tr> <td style="width: 50%; vertical-align: top;"> <p><b>2PO</b> = 2-Plank, 2-Batten <b>3PO</b> = 3-Plank, 2-Batten <b>4PO</b> = 4-Plank, 2-Batten</p> </td> <td style="width: 50%; vertical-align: top;"> <p><b>2PZ</b> = 2-Plank, Z-Batten <b>3PZ</b> = 3-Plank, Z-Batten <b>4PZ</b> = 4-Plank, Z-Batten</p> </td> </tr> <tr> <td style="width: 50%; vertical-align: top;"> <p><b>2P3B</b> = 2-Plank, 3-Batten <b>3P3B</b> = 3-Plank, 3-Batten <b>4P3B</b> = 4-Plank, 3-Batten</p> </td> <td style="width: 50%; vertical-align: top;"> <p><b>2PD</b> = 2-Plank, Diamond <b>3PD</b> = 2-Plank, Diamond <b>4PD</b> = 2-Plank, Diamond</p> </td> </tr> </table>	<p><b>2PO</b> = 2-Plank, 2-Batten <b>3PO</b> = 3-Plank, 2-Batten <b>4PO</b> = 4-Plank, 2-Batten</p>	<p><b>2PZ</b> = 2-Plank, Z-Batten <b>3PZ</b> = 3-Plank, Z-Batten <b>4PZ</b> = 4-Plank, Z-Batten</p>	<p><b>2P3B</b> = 2-Plank, 3-Batten <b>3P3B</b> = 3-Plank, 3-Batten <b>4P3B</b> = 4-Plank, 3-Batten</p>	<p><b>2PD</b> = 2-Plank, Diamond <b>3PD</b> = 2-Plank, Diamond <b>4PD</b> = 2-Plank, Diamond</p>	<p><b>[Height] (1" increments)</b> <b>24</b> = 24" [Minimum] <b>120</b> = 120" [Maximum]</p> <p><b>[Width]</b> <b>12</b> = 12" <b>18</b> = 18" <b>24</b> = 24"</p>
<p><b>2PO</b> = 2-Plank, 2-Batten <b>3PO</b> = 3-Plank, 2-Batten <b>4PO</b> = 4-Plank, 2-Batten</p>	<p><b>2PZ</b> = 2-Plank, Z-Batten <b>3PZ</b> = 3-Plank, Z-Batten <b>4PZ</b> = 4-Plank, Z-Batten</p>				
<p><b>2P3B</b> = 2-Plank, 3-Batten <b>3P3B</b> = 3-Plank, 3-Batten <b>4P3B</b> = 4-Plank, 3-Batten</p>	<p><b>2PD</b> = 2-Plank, Diamond <b>3PD</b> = 2-Plank, Diamond <b>4PD</b> = 2-Plank, Diamond</p>				

## 24" Plank Shutters

Rough Sawn Cedar

4-Plank, 2-Batten

4-Plank, 3-Batten

4-Plank, Z-Batten

Part Number	Part Number	Part Number
 SH4P024X24RS	 SH4P3B24X24RS	 SH4PZ24X24RS
SH4P024X36RS	SH4P3B24X36RS	SH4PZ24X36RS
SH4P024X48RS	SH4P3B24X48RS	SH4PZ24X48RS
SH4P024X60RS	SH4P3B24X60RS	SH4PZ24X60RS
SH4P024X72RS	SH4P3B24X72RS	SH4PZ24X72RS
SH4P024X84RS	SH4P3B24X84RS	SH4PZ24X84RS
SH4P024X96RS	SH4P3B24X96RS	SH4PZ24X96RS
SH4P024X108RS	SH4P3B24X108RS	SH4PZ24X108RS
SH4P024X120RS	SH4P3B24X120RS	SH4PZ24X120RS



### Additional Sizes Available

Shutters measuring 24" - 120", in 1" increments, are available at standard lead time.

## Elliptical Shutters - Board & Batten

Rough Sawn Cedar



### Part Number Logic:

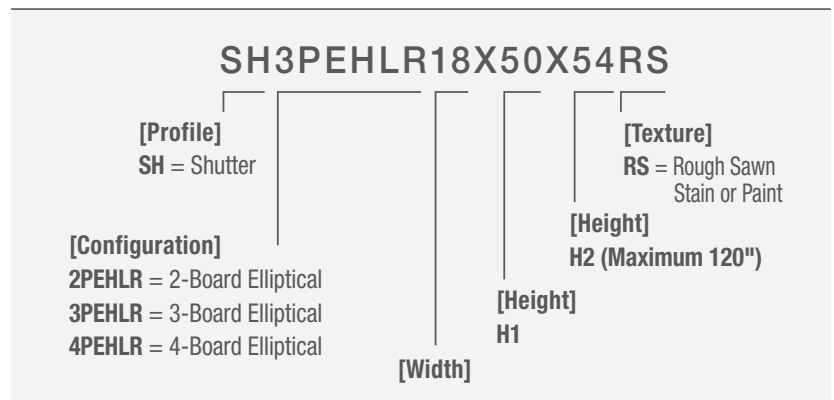

Note: Minimum height (H2) for Elliptical Board & Batten shutters is double the width of the shutter. Example: SH3PEHLR18X35X36RS - 18" = width of shutter and 36" = height (twice the width). If a specific radius is required to complement an elliptical-shaped window, contact your customer service representative to order.

To order an Elliptical Board & Batten shutter that complements the arch of the window, provide measurements of **H1** (in 1/4" increments) and **H2** (in 1" increments) in your part number. See drawing for specific measurement points.

**Example:**

SH3PEHLR18X50X54RS

W
H1
H2

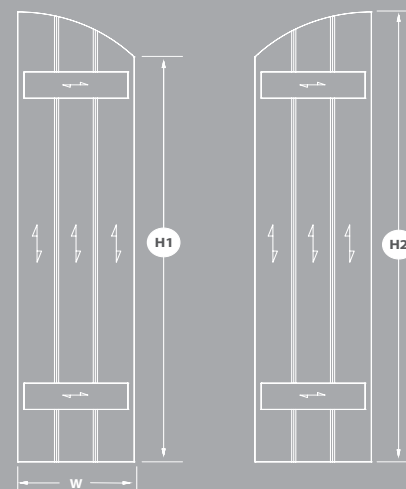



# Elliptical Shutters - Plank

Rough Sawn Cedar



### Part Number Logic:

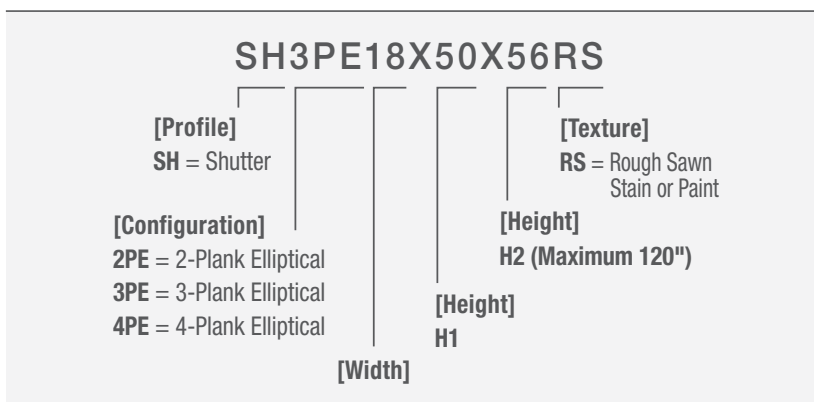

Note: Minimum height (H2) for Elliptical Board & Batten shutters is double the width of the shutter. Example: SH3PE18X35X36RS - 18" = width of shutter and 36" = height (twice the width). If a specific radius is required to complement an elliptical-shaped window, contact your customer service representative to order.

To order an Elliptical Plank shutter that complements the arch of the window, provide measurements of **H1** (in 1/4" increments) and **H2** (in 1" increments) in your part number. See drawing for specific measurement points.

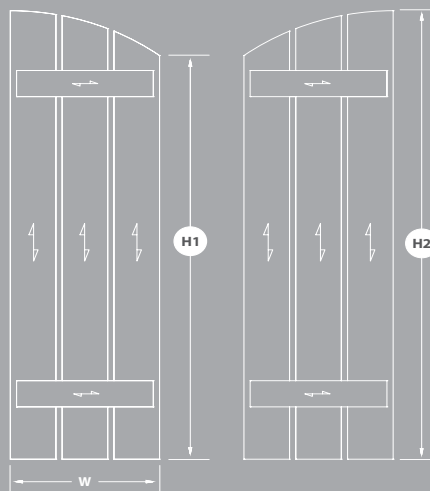
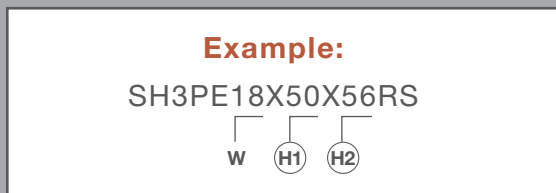



# Diamond Plank Shutters

Rough Sawn Cedar

2-Plank, Diamond

3-Plank, Diamond

4-Plank, Diamond

2-Plank, Diamond		3-Plank, Diamond		4-Plank, Diamond	
Image	Part Number	Image	Part Number	Image	Part Number
	SH2PD12X24RS		SH3PD18X24RS		SH4PD24X24RS
	SH2PD12X36RS		SH3PD18X36RS		SH4PD24X36RS
	SH2PD12X48RS		SH3PD18X48RS		SH4PD24X48RS
	SH2PD12X60RS		SH3PD18X60RS		SH4PD24X60RS
	SH2PD12X72RS		SH3PD18X72RS		SH4PD24X72RS
	SH2PD12X84RS		SH3PD18X84RS		SH4PD24X84RS
	SH2PD12X96RS		SH3PD18X96RS		SH4PD24X96RS
	SH2PD12X108RS		SH3PD18X108RS		SH4PD24X108RS
	SH2PD12X120RS		SH3PD18X120RS		SH4PD24X120RS

Part numbers shown reflect common sizes. For additional options, follow the part number logic below or contact your **Fypon®** representative.

## SH2PD12X24RS

**[Profile]**

SH = Shutter

**[Texture]**

RS = Rough Sawn  
Stain or Paint

**[Configuration]**

2PD = 2-Plank, Diamond  
3PD = 3-Plank, Diamond  
4PD = 4-Plank, Diamond

**[Height] (1" increments)**

24 = 24" [Minimum]  
120 = 120" [Maximum]

**[Width]**

12 = 12"  
18 = 18"  
24 = 24"



## Wood-Grained Panel Shutter with Border



Part Number	Width	Height
SH3PB15X46S	15"	46"
SH3PB18X40S	18"	40"
SH3PB18X66S	18"	66"
SH3PB24X54S	24"	54"

Note: Shutters are sold as a set.



## Wood-Grained Shutter Board Fabrication Panels

Rough Sawn Cedar

	Individual Sheet Part Number	Width	Length	Thickness	Contractor Pack Part Number
	SHBB12X144RS 2-Board Panel	12"	144"	3/4"	SHBB12X144RS-CP*
	SHBB14X144RS 3-Board Panel	14"	144"	3/4"	SHBB14X144RS-CP*
	SHBB18X144RS 3-Board Panel	18"	144"	3/4"	SHBB18X144RS-CP*
	SHBB24X144RS 4-Board Panel	24"	144"	3/4"	SHBB24X144RS-CP*
	FLT1X4-12RS Batten Trim	3-1/2"	144"	3/4"	—

\*Sold in packs of 10.





# Shutter Accessories - Hinges

Colonial & Spear

	Part Number	Length		Part Number	Length
	SHHNGCOL10**	10"		SHHNGSPR10**	10"
	SHHNGCOL16**	16"		SHHNGSPR16**	16"

# Shutter Accessories - Clavos

Round & Pyramid

	Part Number	Diameter		Part Number	Width
	SHCLARND1.25**	1-1/4"		SHCLAPYR1.25**	1-1/4"
	SHCLARND1.25-8PACK	1-1/4"		SHCLAPYR1.25-8PACK	1-1/4"
	SHCLARND1.25-12PACK	1-1/4"		SHCLAPYR1.25-12PACK	1-1/4"
	SHCLARND1.25-18PACK	1-1/4"		SHCLAPYR1.25-18PACK	1-1/4"
	SHCLARND1.25-24PACK	1-1/4"		SHCLAPYR1.25-24PACK	1-1/4"
	SHCLARND1.25-100PACK	1-1/4"		SHCLAPYR1.25-100PACK	1-1/4"



\*\*Sold as a set.

Note: Shutter accessories come primed and ready for paint.

Parts may be required to ship LTL (less than truckload) based on size and overall dimensions.

# Mouldings



It's all in the Details.

Discover a variety of options, ranging from simple to ornate. Our portfolio of beautiful, inspired styles is available in a range of sizes and combinations, ideal for adding character to any home.



Smooth Flat Trim .....86

Brickmould .....87

Wood-Grained Flat Trim .....89

Crown Mouldings .....90

Crown Mouldings - Dentil.....98

Crown Mouldings - Decorative..... 100

Crown Mouldings - Lip ..... 101

Mouldings - Window & Door ..... 104

Mouldings - Base Cap..... 105

Mouldings - Chair Rail..... 108

Mouldings - Fluted ..... 112

Mouldings - Dentil ..... 113

Mouldings - Assorted ..... 116

Moulding Accessories ..... 117

Combination Crown  
E-Vent™ System..... 118

Massive Crown E-Vent™ System... 119

**Product Shown:**  
 Flat Trim  
 Crown Moulding  
 Base Trim



# Mouldings

## How to Use This Section

The products in this section of the catalog are organized by moulding type. You can find a variety of products to match the aesthetics of almost any application conveniently grouped together. Where applicable, groups of mouldings are further sorted by height, from smallest to largest.

## How to Order

### Moulding Accessories

Accessories are available to help make moulding installations quick and easy. Rosettes can be used between moulding lengths to eliminate the need for patching to create smooth seams. All rosettes are unattached and must be ordered separately.

## Moulding Applications

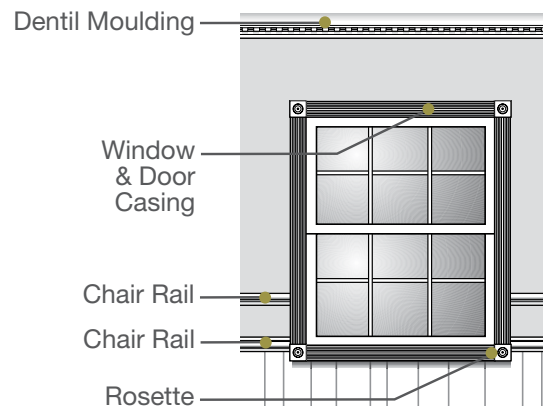
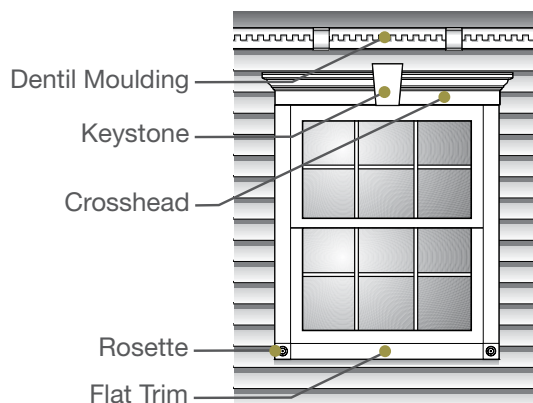



# Smooth Flat Trim

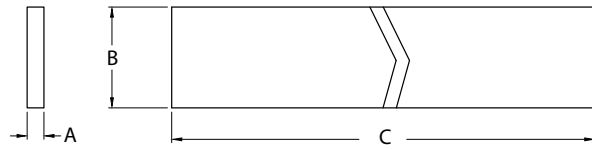

Part Number	Thickness (A)	Width (B)	Length (C)	Accessories
FLT131-16	1/2"	3"	16'	—
FLT178-8	1/2"	14"	8'	—
FLT100-12	5/8"	4-3/4"	12'	—
FLT181-8	5/8"	24"	8'	—
FLT1X3-12	3/4"	2-1/2"	12'	—
FLT101-12	3/4"	1-1/2"	12'	—
FLT102-10	3/4"	2-1/8"	10'	—
FLT103-12	3/4"	3"	12'	PB3X3, PB4X4
FLT122-16	3/4"	3-1/2"	16'	—
FLT110-16	3/4"	5-1/2"	16'	—
FLT109-12	3/4"	6"	12'	—
FLT186-16	3/4"	7-1/4"	16'	—
FLT113-8	3/4"	8"	8'	—
FLT118-8	3/4"	10"	8'	—
FLT152-8	1"	3-1/2"	8'	4F Arches
FLT152-12	1"	3-1/2"	12'	4F Arches
FLT152-16	1"	3-1/2"	16'	4F Arches
FLT153-12	1"	4"	12'	—
FLT159-8	1"	5-1/2"	8'	6F Arches, PB6X6
FLT159-12	1"	5-1/2"	12'	6F Arches, PB6X6
FLT159-16	1"	5-1/2"	16'	6F Arches, PB6X6
FLT162-8	1"	7-1/2"	8'	PB7X7, K8TF
FLT162-14	1"	7-1/2"	14'	PB7X7, K8TF
FLT170-12	1"	9-1/2"	12'	—
FLT170-16	1"	9-1/2"	16'	—
FLT172-16	1"	11-1/2"	16'	—

Note: In order by thickness. Flat trim sold in packs of 4 unless otherwise noted.

\*Sold in quantities of 1 per box.

\*\*Sold in quantities of 2 per box.

Parts may be required to ship LTL (less than truckload) based on size and overall dimensions.



## Smooth Flat Trim

Part Number	Thickness (A)	Width (B)	Length (C)	Accessories
FLT175-12	1"	12"	12'	—
FLT179-12	1"	16"	12'	—
FLT180-12*	1"	24"	12'	—
FLT119-17*	1"	32-1/4"	16' 11"	—
FLT125-8*	1"	36"	8'	—
FLT40X96**	1"	40"	8'	—
FLT194-10	1-1/2"	3-1/2"	10'	—
FLT183-12	1-1/2"	5-1/2"	12'	—
FLT163-16	1-1/2"	7-1/2"	16'	—
FLT182-12	1-1/2"	12-1/4"	12'	—
FLT185-12*	1-1/2"	16-1/2"	12'	—
FLT190-12	2"	4"	12'	—

## Brickmould

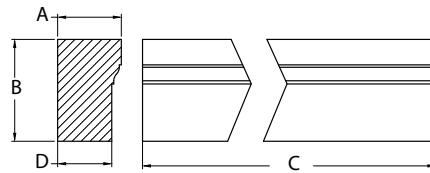

Part Number	Projection (A)	Height (B)	Length (C)	Bottom Thickness (D)	Accessories
MLDWM180-8	1-1/4"	2"	8'	1-1/16"	 Keystone KWM180M Page 55
MLDWM180-16	1-1/4"	2"	16'	1-1/16"	
MLDWM181-16	13/16"	2"	16'	5/8"	
MLDWM182-12	1-1/4"	3"	12'	1-1/16"	





# Wood-Grained Flat Trim

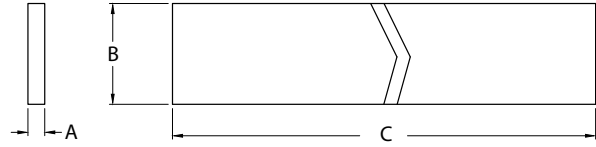









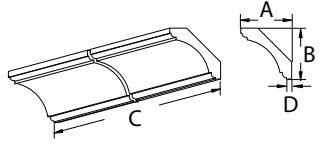

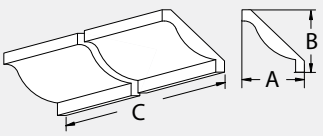

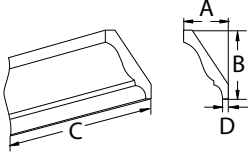

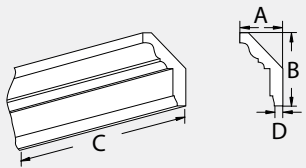
Part Number	Thickness (A)	Width (B)	Length (C)
FLT1X4-12RS	3/4"	3-1/2"	12'
FLT151-12S	3/4"	3-1/2"	12'
FLT110-12S	3/4"	5-1/2"	12'
FLT187-12S	3/4"	7-1/2"	12'
FLT173-12S	3/4"	11-1/2"	12'
FLT30X228X1S*	1"	30"	19'
FLT150-12S	1-1/2"	3-1/2"	12'
FLT111-12S	1-1/2"	5-1/2"	12'
FLT197-12S	1-1/2"	7-1/2"	12'
FLT192-12S	1-1/2"	11-1/2"	12'
FLT9X4X216S**	3-1/2"	8-1/2"	18'

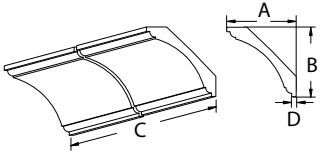

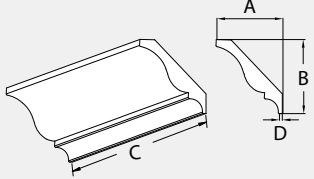

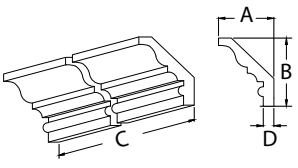

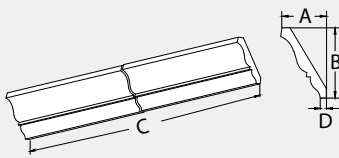
Note: In order by thickness.  
 \*Sold in quantities of 1 per box.  
 \*\*Sold in quantities of 2 per box.  
 Parts may be required to ship LTL (less than truckload) based on size and overall dimensions.

# Crown Mouldings



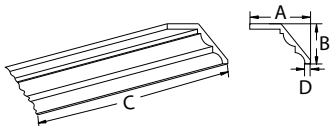

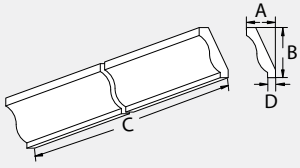

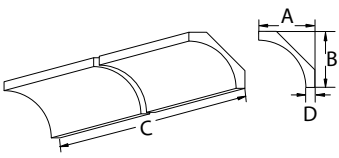
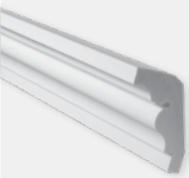
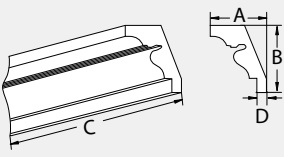



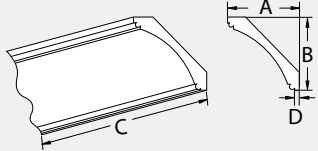

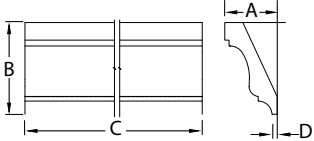
	Part Number	Projection (A)	Height (B)	Length (C)	Bottom Thickness (D)		
	MLD593-16	2-1/2"	2-1/2"	16'	1/4"		
	MLD451-16	3-1/8"	3"	16'	1/2"		
	MLD452-12	2"	3"	12'	1/4"		
	MLD552-12	2-1/8"	3-1/2"	12'	3/8"		
	MLD592-16	3-3/4"	3-7/8"	16'	1/4"		
	MLD454-12	3-5/8"	4-1/8"	12'	1/4"		
	MLD572-16	3-1/4"	4-1/4"	16'	5/8"		
	MLD456-16	2-3/4"	4-3/8"	16'	1/4"		

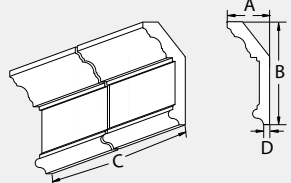

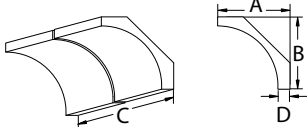

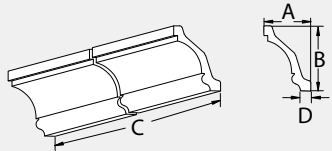

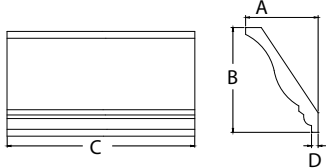

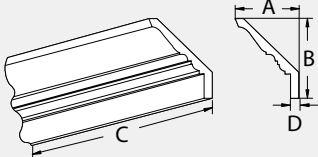



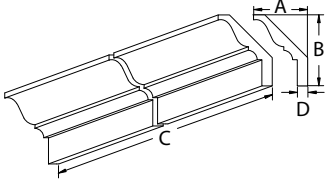

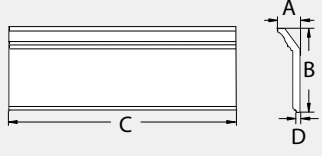
## Crown Mouldings

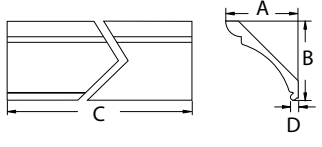
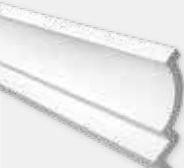
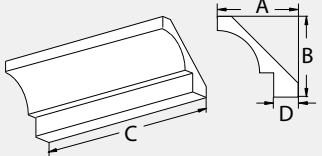
	Part Number	Projection (A)	Height (B)	Length (C)	Bottom Thickness (D)	
	MLD471-12	7-1/8"	4-5/8"	12'	5/8"	
	MLD467-16	2-3/4"	4-3/4"	16'	3/4"	
	MLD584-16	4-3/4"	4-3/4"	16'	3/4"	
	MLD460-12	4-3/8"	5-1/8"	12'	3/4"	

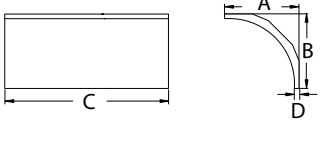

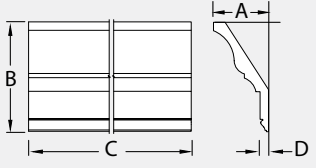

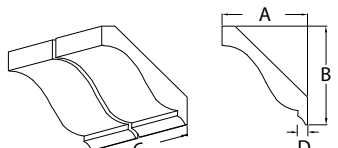

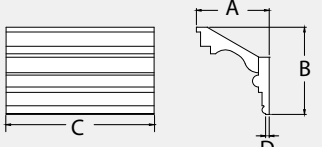



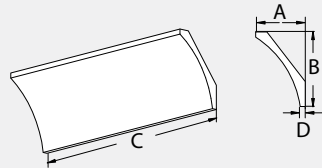

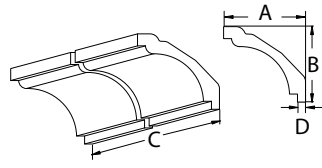
# Crown Mouldings

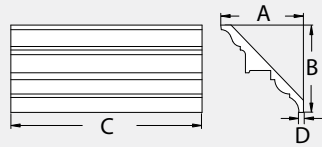
	Part Number	Projection (A)	Height (B)	Length (C)	Bottom Thickness (D)	
	MLD606-12	5-1/4"	5-1/4"	12'	1/4"	
	MLD1037-12	3-1/8"	5-5/8"	12'	1/4"	
	MLD587-16	2-3/8"	5-3/4"	16'	3/8"	
	MLD590-16	6"	6-1/4"	16'	1"	
	MLD589-16	4-3/8"	6-1/2"	16'	1-1/8"	
	MLD453-16	4-3/4"	6-3/4"	16'	1/2"	
	MLD570-12	5-1/2"	6-7/8"	12'	3/4"	

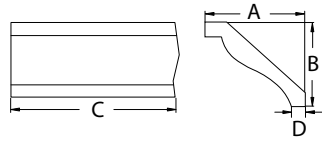
# Crown Mouldings

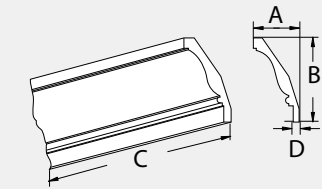

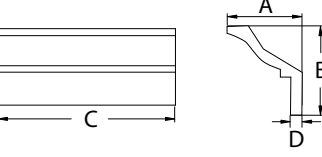

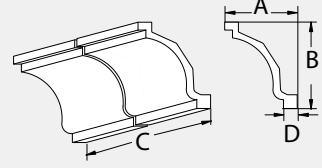





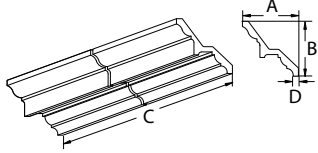

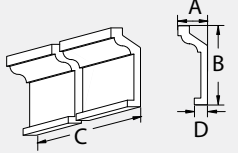

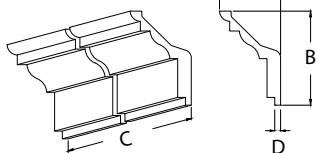
	Part Number	Projection (A)	Height (B)	Length (C)	Bottom Thickness (D)	
	MLD569-12	5-3/4"	7-1/2"	12'	1-1/8"	
	MLD253-16	2-3/8"	7-5/8"	16'	3/8"	
	MLD457-12	6-7/8"	7-5/8"	12'	3/4"	
	MLD582-12	7-7/8"	7-7/8"	12'	2-3/8"	
	MLD583-16	8"	8"	16'	1/2"	
	MLD1001-12	4-1/8"	8-1/8"	12'	1/8"	
	MLD1002-12	5-1/8"	10-1/8"	12'	1/8"	
	MLD449-16	7-1/8"	8-1/2"	16'	1/8"	
	MLD480-12 Ships in two pieces.	7-7/8"	8-7/8"	12'	3/8"	

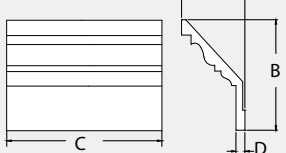
# Crown Mouldings

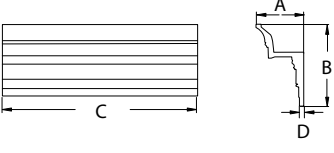
	Part Number	Projection (A)	Height (B)	Length (C)	Bottom Thickness (D)	
	MLD635-12	6"	9"	12'	5/8"	
	MLD591-16	10-1/4"	9-1/2"	16'	1"	
	MLD535-16	9"	9-1/2"	16'	1/2"	
	MLD450-16	11-1/2"	9-5/8"	16'	1-1/2"	
	MLD555-12	5-1/4"	10-3/4"	12'	7/8"	
	MLD371-16	6-1/2"	11"	16'	1"	
	MLD588-16	9-1/4"	11"	16'	1-3/4"	

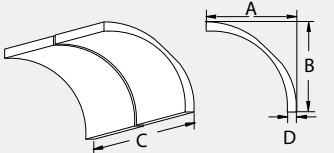

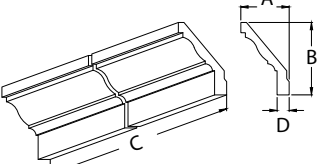

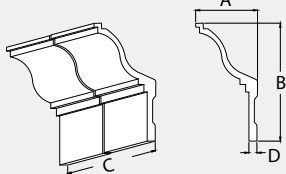

# Crown Mouldings

	Part Number	Projection (A)	Height (B)	Length (C)	Bottom Thickness (D)	
	MLD642-12	12"	11-3/4"	12'	1-3/8"	
	MLD539-16	4-1/2"	12"	16'	2"	
	MLD524-16	8"	12-1/8"	16'	1"	
	MLD580-12	7-1/8"	12-3/8"	12'	1"	
	MLD372-14	8-1/4"	13-7/8"	14'	3/4"	
	MLD734-12	14-3/8"	14-3/8"	12'	1-1/4"	
	MLD556-16	10"	15"	16'	2-1/2"	
	MLD536-12	8-1/8"	15-1/2"	12'	1"	



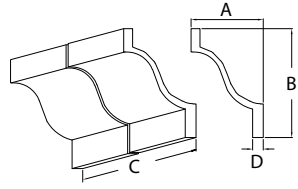

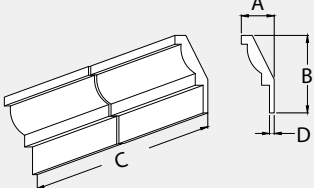
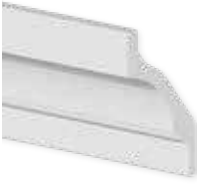
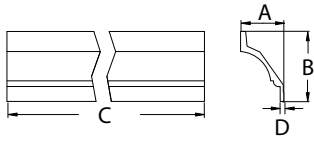

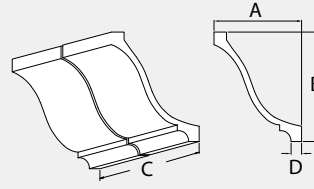







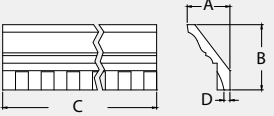

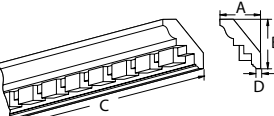

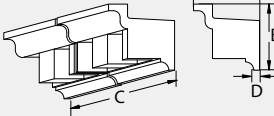

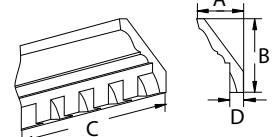
## Crown Mouldings

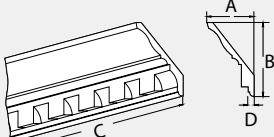
	Part Number	Projection (A)	Height (B)	Length (C)	Bottom Thickness (D)	
	MLD528-12	9-1/2"	15-3/4"	12'	1-1/2"	
	MLD586-16	7"	16-1/2"	16'	1"	
	MLD585-12	10-1/2"	17"	12'	7/8"	
	MLD481-12	14"	17-1/2"	12'	1-3/4"	

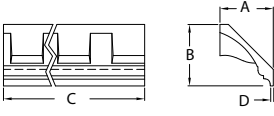
# Crown Mouldings

Dentil

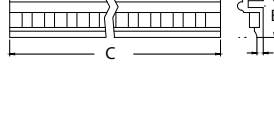
Mouldings

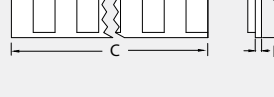
	Part Number	Projection (A)	Height (B)	Length (C)	Bottom Thickness (D)	Design Repeat	Tooth & Space	
	MLD404-16	2-1/2"	3-7/8"	16'	1/4"	1-1/2"	3/4" Tooth 3/4" Space	
	MLD406-16	3-3/8"	4"	16'	3/8"	2"	1-1/4" Tooth 3/4" Space	
	MLD365-16	5"	5"	16'	3/8"	4-5/8"	2-1/4" Tooth 2-3/8" Space	
	MLD410-12	3-1/4"	6-7/8"	12'	1/2"	3"	1-1/2" Tooth 1-1/2" Space	
	MLD411-16	4-1/2"	7"	16'	1/2"	3"	1-1/2" Tooth 1-1/2" Space	
	MLD440-12	6-1/2"	7-1/4"	12'	3/8"	6-5/8"	4" Tooth 2-5/8" Space	
	MLD430-12	5-3/4"	8"	12' 2-1/4"	1/4"	2-5/8"	1-3/4" Tooth 7/8" Space	
	MLD362-16	5-1/8"	8-3/8"	16'	1-1/4"	4-1/2"	2" Tooth 2-1/2" Space	
	MLD336-16	3-1/8"	9-3/8"	16' 1"	3/4"	5"	2-1/2" Tooth 2-1/2" Space	



# Crown Mouldings







Dentil

	Part Number	Projection (A)	Height (B)	Length (C)	Bottom Thickness (D)	Design Repeat	Tooth & Space	
	MLD435-16	9"	10"	16'	3/4"	7-3/8"	3-7/8" Tooth 3-1/2" Space	
	MLD412-16	5-3/8"	10-5/8"	16'	1/2"	4"	3" Tooth 1" Space	
	MLD413-12	8-1/2"	11-1/8"	12'	1-1/2"	5-5/8"	3" Tooth 2-5/8" Space	
	MLD419-12	6-3/4"	14-1/2"	12'	1-3/8"	3"	1-1/2" Tooth 1-1/2" Space	
	MLD421-12	10"	14-1/2"	12'	3/4"	6"	2" Tooth 4" Space	
	MLD461-8	9-7/8"	19"	8'	1"	2-1/2"	1-1/2" Tooth 1" Space	



# Crown Mouldings











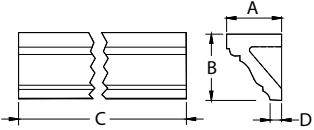

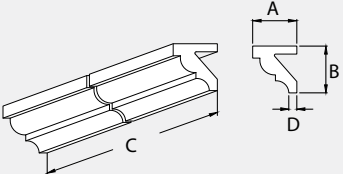

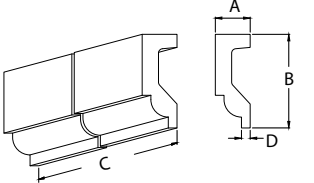
Decorative

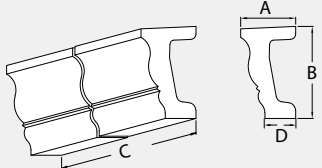
Part Number	Projection (A)	Height (B)	Length (C)	Bottom Thickness (D)	Design Repeat
 MLD562-8 Egg & Dart	2-3/8"	3"	8' 5"	1/2"	6-1/8"
 MLD600-10 Florentine	3/4"	4-1/4"	10'	1/4"	5-5/8"
 MLD490-12 Florentine	6"	5-1/2"	11' 5"	1/4"	—
 MLD640-8 Scalloped	1"	5-3/4"	8'	1"	6"
 MLD493-12 Crown Leaf	5-1/2"	6-5/8"	12'	3/8"	4"
 MLD732-12	4-3/4"	7-1/4"	12'	5/8"	5-3/8"
 MLD425-12	4-1/8"	9-1/2"	11' 5"	3/4"	13-1/2"

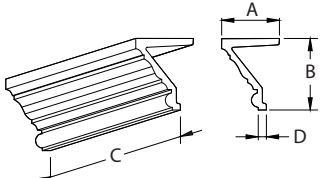
5/8" Tooth, 13/16" Space

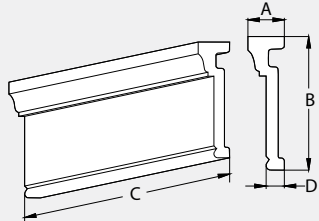
# Crown Mouldings



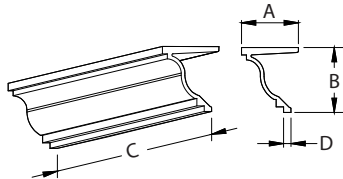
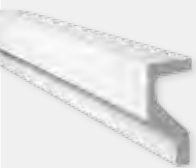
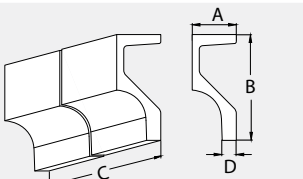







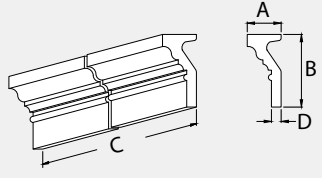

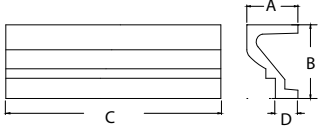

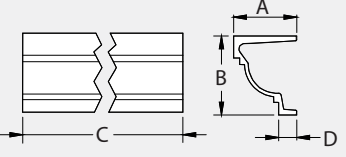

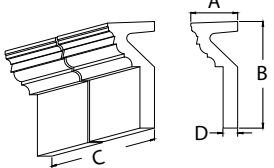
Lip

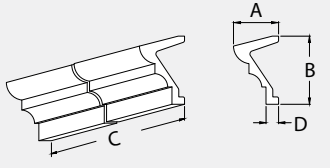
	Part Number	Projection (A)	Height (B)	Length (C)	Bottom Thickness (D)	
	MLD240-8	3-1/4"	4"	8'	3/4"	
	MLD513-16	4-1/8"	4-3/8"	16'	3/4"	
	MLD523-16	2"	5-1/4"	16'	1/2"	
	MLD509-16	3-1/4"	5-3/8"	16'	1-3/4"	
	MLD510-12	4-3/8"	5-1/2"	12'	5/8"	
	MLD226-10	1-1/2"	5-1/2"	10'	3/4"	
	MLD226-12	1-1/2"	5-1/2"	12'	3/4"	
	MLD226-16	1-1/2"	5-1/2"	16'	3/4"	
	MLD511-12	5-3/4"	6-1/2"	12'	3/4"	
	MLD548-16	3-1/8"	7-1/2"	16'	1-1/8"	

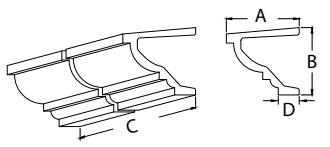
# Crown Mouldings

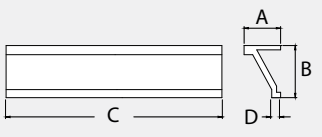
Lip

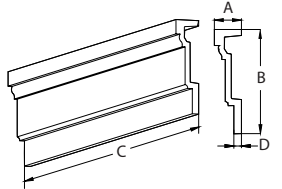

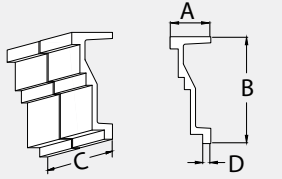



Mouldings

	Part Number	Projection (A)	Height (B)	Length (C)	Bottom Thickness (D)	
	MLD527-16	3-1/2"	7-5/8"	16'	1"	
	MLD311-16	5-3/8"	7-3/4"	16'	2-3/8"	
	MLD520-16	6-1/8"	8-1/8"	16'	1-7/8"	
	MLD508-12	3-5/8"	8-3/8"	12'	1-1/8"	
	MLD547-16	5-3/8"	8-5/8"	16'	1-1/2"	
	MLD545-12	10"	9-1/8"	12'	2-7/8"	
	MLD512-16	8-1/2"	12-1/8"	16'	2-1/8"	
	MLD505-8 Massive Fascia	3-3/8"	13"	8'	1"	
	MLD521-8	5"	13-1/8"	8'	1"	

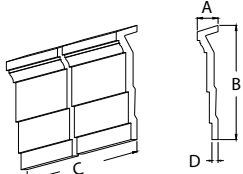

# Crown Mouldings

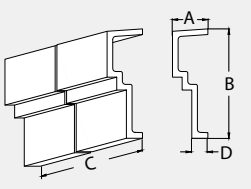

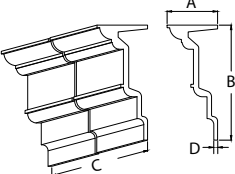
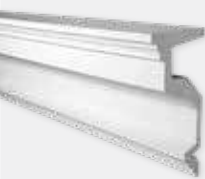
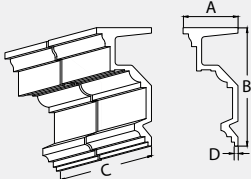



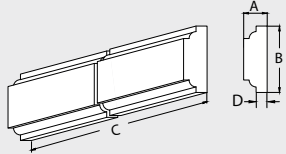

Lip

	Part Number	Projection (A)	Height (B)	Length (C)	Bottom Thickness (D)		
	MLD472-12	11-1/4"	15-1/2"	12'	1-1/8"		
	MLD506-16	3"	16-3/8"	16'	7/8"		
	MLD533-12	5-1/2"	17"	12'	2-1/2"		
	MLD543-12	8-1/4"	19"	12'	1/2"		
	MLD534-12	8-7/8"	19-1/8"	12'	1/2"		

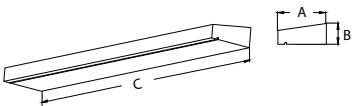

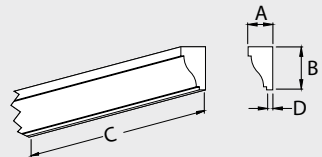
# Mouldings

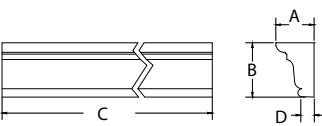

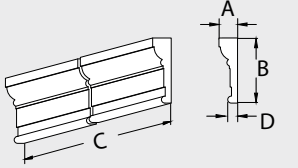







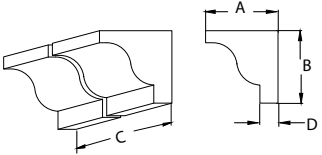

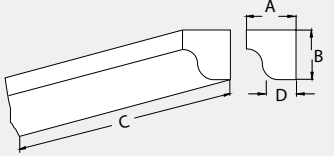

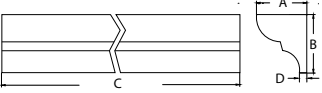
Window & Door

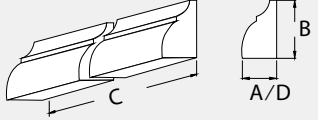
	Part Number	Projection (A)	Height (B)	Length (C)	Bottom Thickness (D)	
	MLD637-16 Flat Astragal	1/2"	1-1/2"	16'	3/4"	
	MLD710-10 Sill	3-1/2"	1-1/2" Tapers to 1"	10'	—	
	MLD231-12 Window & Door Casing	1"	1-3/4"	12'	1/4"	
	MLD214-12 Window & Door Casing	2"	2-7/8"	12'	3/4"	
	MLD234-16 Window & Door Casing	1"	3-1/2"	16'	3/8"	

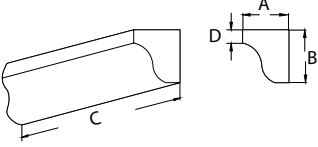

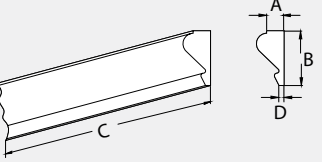

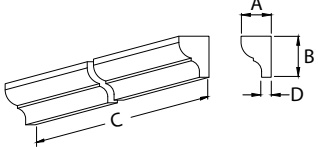

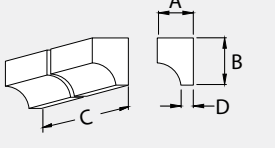





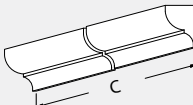
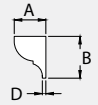

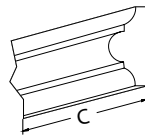
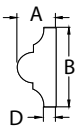

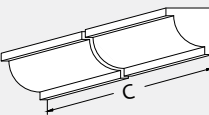

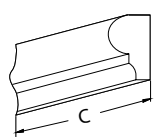
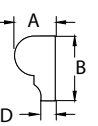
# Mouldings

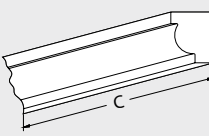
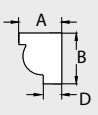
## Base Cap

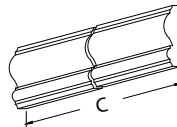
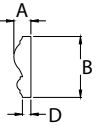
	Part Number	Projection (A)	Height (B)	Length (C)	Bottom Thickness (D)	
	MLD633-8	3/4"	3/4"	8'	1/4"	
	MLD602-8 Crosshead Trim Strip	3/4"	3/4"	8'	1/4"	
	MLD626-8	1-1/8"	1-1/4"	8'	1/8"	
	MLD618-16 Base Cap	1"	1-1/2"	16'	1"	
	MLD601-12	1-1/4"	1-1/2"	12'	3/8"	
	MLD612-12	3/4"	1-3/8"	12'	1/8"	
	MLD634-16	1-3/8"	1-7/8"	16'	1/4"	
	MLD627-16	1-5/8"	2-1/8"	16'	1/2"	

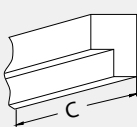
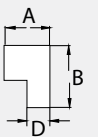
# Mouldings

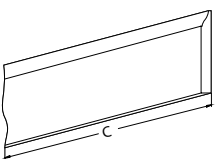
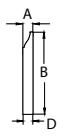

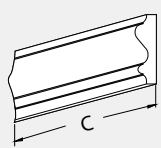
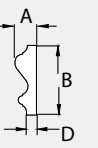







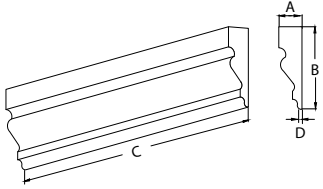

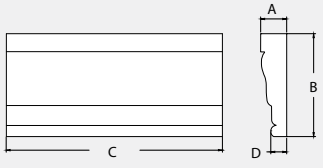
## Base Cap

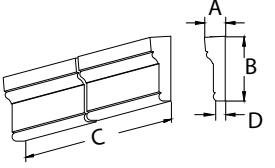
	Part Number	Projection (A)	Height (B)	Length (C)	Bottom Thickness (D)		
	MLD649-16	1-1/2"	2-1/8"	16'	3/8"		
	MLD611-12	1-1/8"	2-1/4"	12'	3/8"		
	MLD629-10	2-1/4"	2-1/4"	10'	3/8"		
	MLD610-8	1-1/2"	2-3/8"	8'	1/2"		
	MLD613-12	2-3/8"	2-3/4"	12'	1"		
	MLD631-16	7/8"	3"	16'	1/2"		
	MLD625-16	3"	4"	16'	1-1/2"		
	MLD706-16 Base Trim	5/8"	5-1/4"	16'	—		
	MLD614-16	1-5/8"	5-1/2"	16'	3/4"		



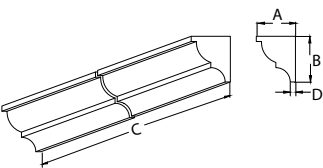

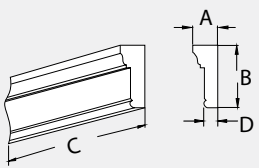

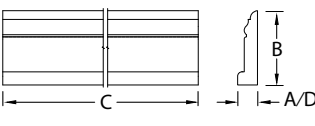
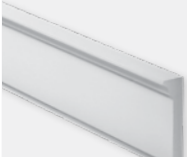
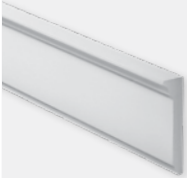
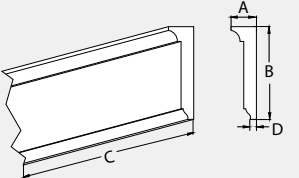





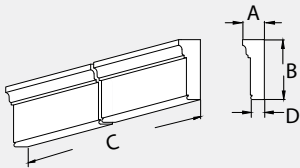

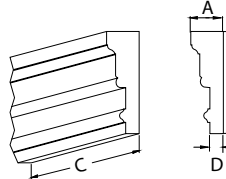
# Mouldings

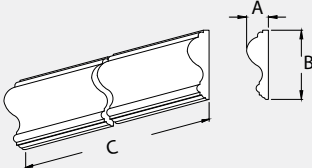
## Chair Rail

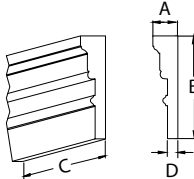
	Part Number	Projection (A)	Height (B)	Length (C)	Bottom Thickness (D)	
	MLD621-16	1/2"	2"	16'	18"	
	MLD230-16	3/4"	3-1/4"	16'	1/2"	
	MLD237-16	1-1/8"	3-1/2"	16'	3/8"	
	MLD715-16 Beaded	1"	4"	16'	—	
	MLD641-16	3-3/4"	4-3/8"	16'	1/2"	
	MLD250-8	1-3/4"	4-1/2"	8'	1"	
	MLD250-12	1-3/4"	4-1/2"	12'	1"	
	MLD1019-12	1-1/8"	5-1/4"	12'	1-1/8"	
	MLD1020-12	1-1/8"	7-1/4"	12'	1-1/8"	
	MLD224-12	1-1/2"	5-1/2"	12'	3/8"	

# Mouldings

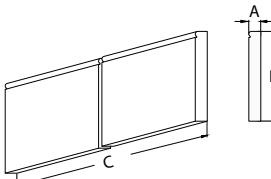

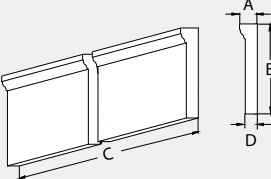







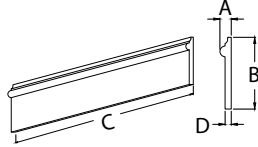

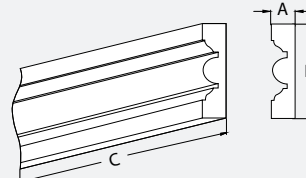

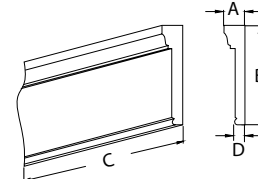
## Chair Rail

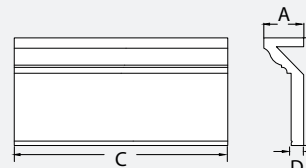
	Part Number	Projection (A)	Height (B)	Length (C)	Bottom Thickness (D)	Accessories	
	MLD236-16	2"	5-1/2"	16'	1-1/4"	—	
	MLD220-12 6M Profile	1-3/4"	5-1/2"	12'	3/4"	K6TM KP6TM	
	MLD220-16 6M Profile	1-3/4"	5-1/2"	16'	3/4"		
	MLD639-16	1-7/8"	6-1/4"	16'	—	—	
	MLD221-8	1-3/4"	7"	8'	3/4"	—	
	MLD221-16	1-3/4"	7"	16'	3/4"		
	MLD705-16 Cove	3/4"	7-1/2"	16'	—	—	
	MLD735-16 Beaded	1"	7-1/2"	16'	—	—	
	MLD232-16	1-1/2"	7-7/8"	16'	1-1/8"	—	

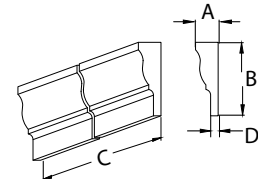

# Mouldings

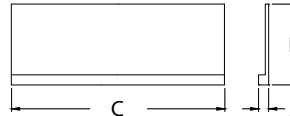

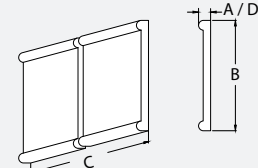

## Chair Rail

	Part Number	Projection (A)	Height (B)	Length (C)	Bottom Thickness (D)	
	MLD247-16	1- <sup>3</sup> / <sub>8</sub> "	8- <sup>3</sup> / <sub>4</sub> "	16'	3/4"	
	MLD245-12	2"	8- <sup>3</sup> / <sub>4</sub> "	12'	—	
	MLD227-16	1- <sup>1</sup> / <sub>2</sub> "	9"	16'	3/4"	
	MLD246-16	3- <sup>3</sup> / <sub>8</sub> "	9- <sup>1</sup> / <sub>8</sub> "	16'	1"	
	MLD644-16	3"	9- <sup>3</sup> / <sub>4</sub> "	16'	1"	
	MLD530-8 Coordinates with MLD531-8	1- <sup>1</sup> / <sub>2</sub> "	12- <sup>5</sup> / <sub>8</sub> "	8'	—	
	MLD531-8 Coordinates with MLD530-8	1- <sup>1</sup> / <sub>2</sub> "	12"	8'	—	
	MLD522-16	1- <sup>5</sup> / <sub>8</sub> "	14- <sup>3</sup> / <sub>4</sub> "	16'	1- <sup>5</sup> / <sub>8</sub> "	

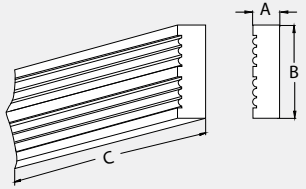

# Mouldings

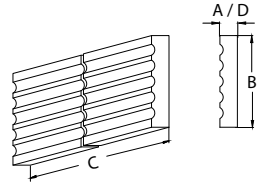

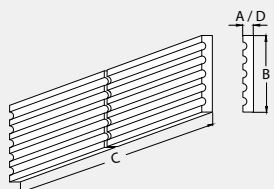







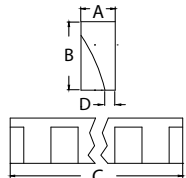

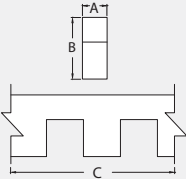
Fluted

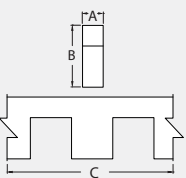
	Part Number	Projection (A)	Height (B)	Length (C)	Bottom Thickness (D)	Accessories	
	MLD205-12	7/8"	3"	12'	—	PB3X3, PB4X4	
	MLD207-16	1"	5-1/4"	16'	1"	PB6X6	
	MLD208-16	1"	7-1/4"	16'	1"	—	

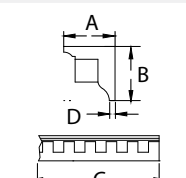

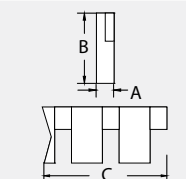

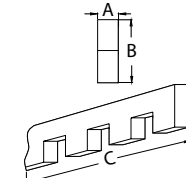

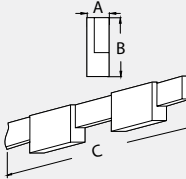





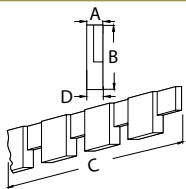

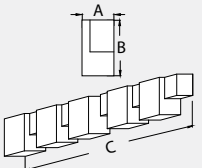

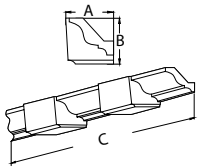

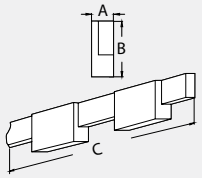

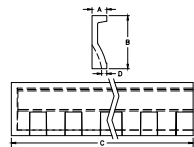
# Mouldings

## Dentil

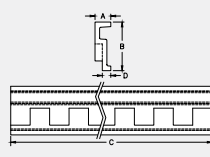
	Part Number	Projection (A)	Height (B)	Length (C)	Bottom Thickness (D)	Design Repeat	Tooth & Space	
	MLD303-5 WCHX6 Dentil Trim	5/8"	1-1/4"	5'	1/4"	1-1/2"	3/4" Tooth 3/4" Space	
	MLD357-8 CHTX6 Dentil Trim	1/2"	1-1/4"	8'	—	1-1/2"	3/4" Tooth 3/4" Space	
	MLD304-8 WCHX9 Dentil Trim	5/8"	1-1/4"	8'	1/4"	2-1/2"	1-1/4" Tooth 1-1/4" Space	
	MLD358-8 CHTX9 Dentil Trim	1/2"	1-1/2"	8'	—	2"	1" Tooth 1" Space	
	MLD313-8	2-1/4"	2-3/8"	8'	1/4"	2"	1" Tooth 1" Space	
	MLD355-8	5/8"	2-1/2"	8' 3/8"	—	2-1/8"	1-3/8" Tooth 3/4" Space	
	MLD354-12	1"	3-1/8"	12' 2-1/4"	—	3-1/4"	1-5/8" Tooth 1-5/8" Space	
	MLD351-8	1-1/4"	3-1/4"	8' 2"	—	7"	3-1/2" Tooth 3-1/2" Space	

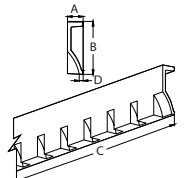
# Mouldings



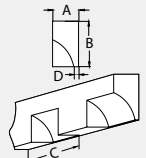



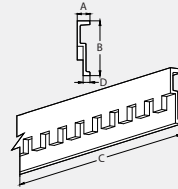

Dentil

	Part Number	Projection (A)	Height (B)	Length (C)	Bottom Thickness (D)	Design Repeat	Tooth & Space	
	MLD350-8	7/8"	3-1/2"	8' 3-3/4"	1/2"	3-3/4"	2-3/16" Tooth 1-1/2" Space	
	MLD352-8	2"	3-1/2"	8' 3-3/4"	—	3-3/4"	2-1/4" Tooth 1-1/2" Space	
	MLD360-8	3-1/2"	3-3/4"	8'	—	8"	3-3/4" Tooth 4-3/8" Space	
	MLD353-8	1-1/4"	4-1/2"	8' 1/4"	—	8-3/4"	4-3/8" Tooth 4-3/8" Space	
	MLD310-8	1-1/4"	4-1/2"	8'	1/2"		1-1/2" Tooth	
	MLD310-12	1-1/4"	4-1/2"	12'	1/2"	3"	1-1/2" Tooth	
	MLD310-16	1-1/4"	4-1/2"	16'	1/2"			
	MLD332-8	1-5/8"	5"	8'	7/8"	4"	2" Tooth 2" Space	
	MLD320-8	1-5/8"	5-3/4"	8'	3/8"		2-3/8" Tooth	
	MLD320-12	1-5/8"	5-3/4"	12'	3/8"	4-1/2"	2-1/4" Space	
	MLD320-16	1-5/8"	5-3/4"	16' 1-1/2"	3/8"			
	MLD335-12	3-3/8"	6-1/8"	12'	1/2"	7-3/16"	3-9/16" Tooth 4-10/16" Space	

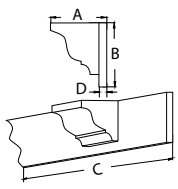

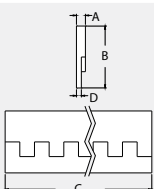
# Mouldings

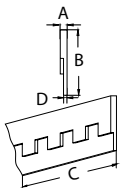

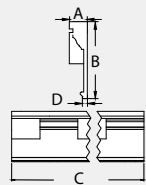







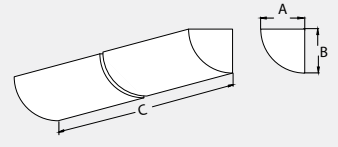

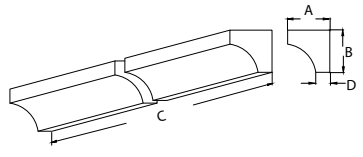
Dentil

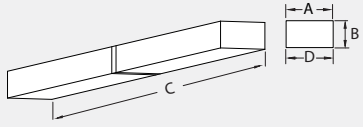
	Part Number	Projection (A)	Height (B)	Length (C)	Bottom Thickness (D)	Design Repeat	Tooth & Space	
	MLD330-12	1-5/8"	7"	12'	7/8"	4"	2" Tooth 2" Space	
	MLD370-8	6-1/2"	7-1/2"	8'	1"	19-1/4"	4-3/4" Tooth 14-1/2" Space	
	MLD331-16	1-3/8"	9-1/2"	16' 1-1/2"	3/4"	4-1/2"	2-1/4" Tooth 2-1/4" Space	
	MLD333-12	1-3/16"	11-1/2"	12' 4-1/2"	5/8"	5-1/2"	2-3/4" Tooth 2-3/4" Space	
	MLD434-16	3-3/4"	16"	15' 9"	1/8"	21"	9" Tooth 12" Space	
	Note: Part comes with routed channel as shown in profile line art.							

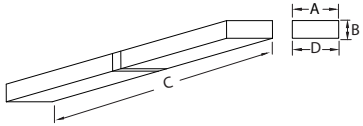
# Mouldings

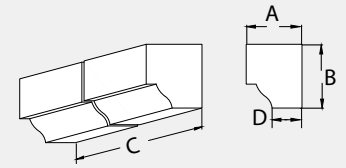

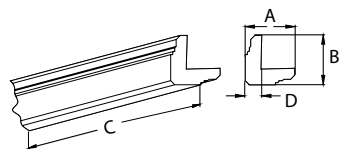
Assorted

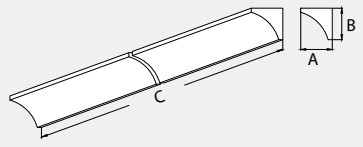
Mouldings

	Part Number	Projection (A)	Height (B)	Length (C)	Bottom Thickness (D)	
	MLD603-8 Quarter Round	1/2"	1/2"	8'	3/4"	
	MLD628-8 Cove	3/4"	3/4"	8'	1/4"	
	MLD716-12 Bottom Trim Accessory for 6" high Distinction crosshead	1"	1"	8'	1-3/4"	
	MLD758-12 Bottom Trim Accessory for 9" high Distinction crosshead	1"	1"	8'	1-3/4"	
	MLD730-8 Stop	7/8"	1"	8'	1/4"	
	MLD607-8 Corner Strip	2-1/4"	2-1/4"	8'	3/4"	
	MLD660-10 Cove	2-3/8"	2-3/8"	10'	—	

# Mouldings

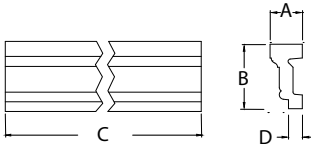
Assorted

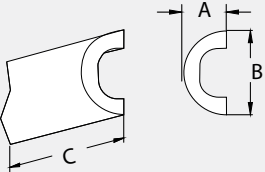
	Part Number	Projection (A)	Height (B)	Length (C)	Bottom Thickness (D)	Accessories	
	MLD215-12 4M Profile	1-3/4"	3-1/2"	12'	3/4"	K4TM KP4TM	
	MLD605-12 Half Round	1-3/4"	3-1/2"	12'	—	—	

# Moulding Accessories





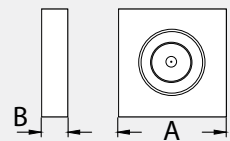

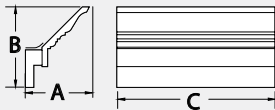

Rosettes

	Part Number	Width (A)	Projection (B)	Matching Parts
	PB2.5X2.5	2-1/2"	3/4"	—
	PB3X3	3-5/8"	7/8"	FLT103 MLD205
	PB3.5X3.5	3-1/2"	3/4"	—
	PB3.875X3.875	3-7/8"	1-1/8"	—
	PB4X4	3-5/8"	1-1/8"	FLT103 MLD205 4F Arches
	PB5X5	5-1/4"	1"	FLT109
	PB6X6	5-5/8"	1-1/8"	FLT159 MLD706 6F Arches

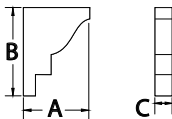

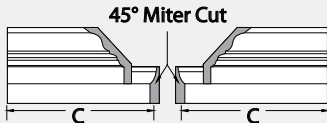
# Combination Crown E-Vent™ System

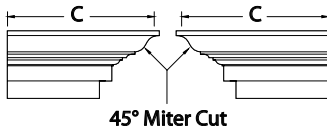
570 System

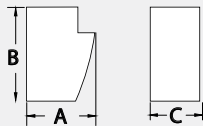







	Part Number	Projection (A)	Height (B)	Width / Length (C)	
	<b>EV570</b> Moulding Matches MLD570	7-7/16"	9-5/16"	144"	
	<b>EV570B</b> Joint Block / End Cap	7-1/2"	9-7/16"	1-3/4"	
	<b>EV570MI</b> Inside Corner Ships in 2 pieces	7-7/16"	9-5/16"	17"	
	<b>EV570MO</b> Outside Corner Ships in 2 pieces	7-7/16"	9-5/16"	22"	
	<b>EVFB</b> Filler Block Fits all E-Vent Systems	1-3/8"	1-15/16"	1"	

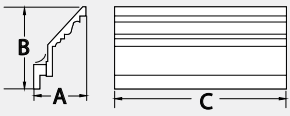

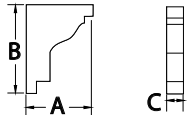

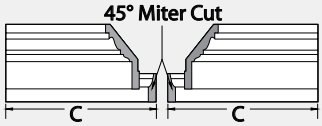
# Massive Crown E-Vent™ System

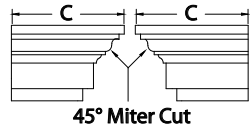
580 System

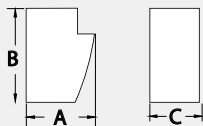
	Part Number	Projection (A)	Height (B)	Width / Length (C)	
	EV580 Moulding Matches MLD580	9-1/32"	14-3/4"	144"	
	EV580B Joint Block / End Cap	9-1/4"	14-11/16"	1-3/4"	
	EV580MI Inside Corner Ships in 2 pieces	9-1/32"	14-3/4"	21-31/32"	
	EV580MO Outside Corner Ships in 2 pieces	9-1/32"	14-3/4"	22-1/32"	
	EVFB Filler Block Fits all E-Vent Systems	1-3/8"	1-15/16"	1"	

# Decorative Millwork



DISCOVER UNLIMITED POSSIBILITIES.

Our collection of architecturally correct and historically accurate decorative millwork adds a refined look to both interior and exterior applications.





**Product Shown:**  
 Rough Sawn Beams  
 Beam Straps

Smooth Brackets..... 124

Smooth Knee Braces ..... 140

Smooth Dentic Blocks..... 141

Wood-Grained Brackets..... 146

Wood-Grained Knee Braces..... 149

Wood-Grained Corbels..... 151

Wood-Grained Rafter Tails ..... 156

Trellis Systems..... 158

**NEW** Smooth Beam ..... 160

Smooth Classic Beam..... 163

Wood-Grained Beams..... 164

Wood-Grained Beam Mantels..... 172

Gable Pediments..... 174

Ceiling Medallions ..... 177

Decorative Panels ..... 178

Fishscale Panel ..... 179

Tile Vents ..... 180

Fixture Mounts ..... 181

Spires ..... 182

Finials ..... 183



# Decorative Millwork

---

## HOW TO USE THIS SECTION

The products in this section of the catalog are organized by product type. You can find a variety of products to match the aesthetics of almost any application conveniently grouped together. Where applicable, groupings of brackets, corbels, rafter tails, beams, dentil blocks and other products are further sorted by height, from smallest to largest.

---

## HOW TO ORDER

### Decorative Millwork Accessories

Some decorative millwork products have accessories available or are an accessory to another product. All decorative millwork accessories are unattached and must be ordered separately.







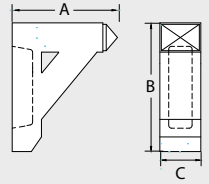

# Smooth Brackets

Flat

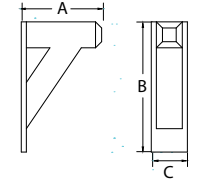
Decorative Millwork









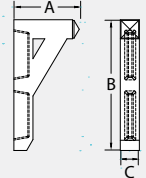

	Part Number	Projection (A)	Height (B)	Overall Width (C)	
	BKT9X11	9"	11"	3-1/2"	
	BKT12X12X4	12"	12"	3-1/2"	
	BKT18X18X4	18"	18"	3-1/2"	
	BKT16X16	15-7/8"	15-7/8"	2"	
	BKT10X16X4	9-7/8"	16"	4-1/2"	
	BKT12X16	11-1/2"	16"	3"	
	BKT14X16X4	14"	16"	4-1/2"	
	BKT17X17	16-1/2"	16-1/2"	3-1/2"	
	BKT16X18X3	16"	18"	3-1/2"	
	BKT11X20	11"	20"	3-1/8"	

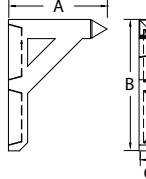

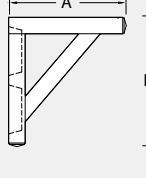

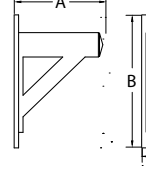

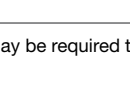





# Smooth Brackets

Flat

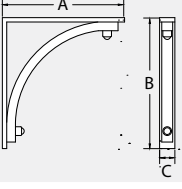
	Part Number	Projection (A)	Height (B)	Overall Width (C)	
	BKT12X24X3	12"	24"	3-1/2"	
	BKT18X24X4	18"	24"	3-1/2"	
	BKT18X30X4	18"	30"	3-1/2"	
	BKT25X27	25"	27-1/2"	3-1/2"	
	BKT36X36X4	36"	36"	4"	
	BKT36X36X6	36"	36"	6"	
	BKT20X30X6	20"	30"	5-1/2"	
	BKT32X32	32"	32"	6"	
	BKT40X40	40"	40"	6"	

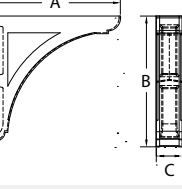
# Smooth Brackets

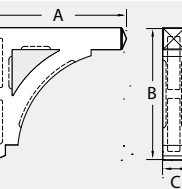
Cove / Arch

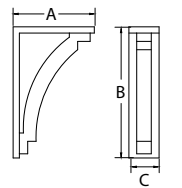









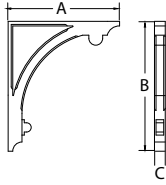

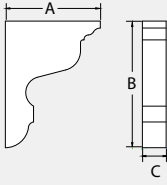

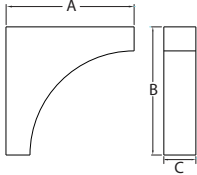
	Part Number	Projection (A)	Height (B)	Overall Width (C)	
	BKT15X18X6	15"	18"	6"	
	BKT19X24X4	18 <sup>5</sup> / <sub>8</sub> "	24"	4"	
	BKT19X36X4	19"	36"	4"	
	BKT20X24X5	20"	24"	5"	
	BKT25X25	25"	25"	4"	
	BKT28X30	28"	30"	3-1/2"	
	BKT30X30	30"	30"	6"	
	BKT36X36	36-1/8"	36-1/8"	6"	
	BKT31X30X5	31"	30"	5"	
	BKT19X31	19-1/2"	31-1/2"	7-1/4"	
	BKT24X36	24"	36"	3-1/2"	

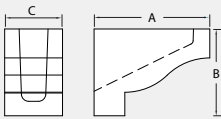

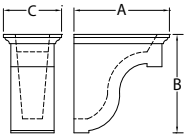

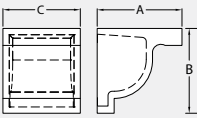

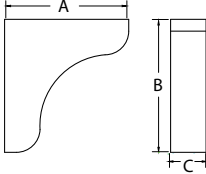

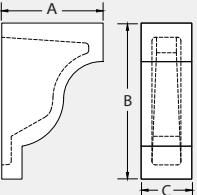





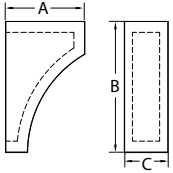

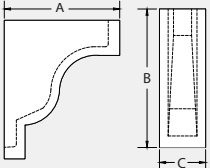
# Smooth Brackets

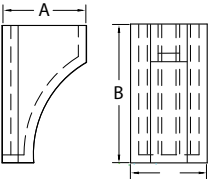
Cove / Arch

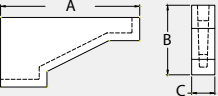
	Part Number	Projection (A)	Height (B)	Overall Width (C)	
	BKT36X42	36-1/4"	42-1/4"	3-1/2"	
	BKT6X8	6"	8"	1-1/2"	
	BKT8X8	8"	8"	2"	
	BKT8X6	8"	6"	4"	
	BKT8X8X4	8"	8"	4-7/8"	
	BKT10X10X9	10"	10"	9-1/8"	
	BKT10X11	10-1/2"	11-1/4"	3"	
	BKT7X11X3	7"	11"	3-1/2"	

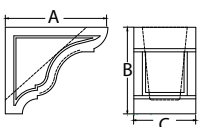
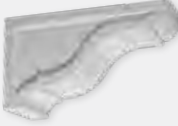
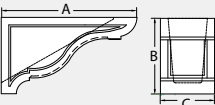
# Smooth Brackets

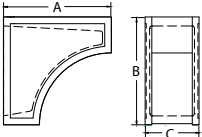

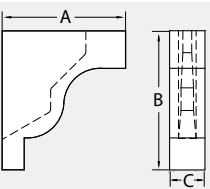



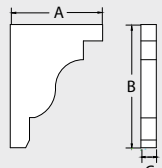

Cove / Arch

	Part Number	Projection (A)	Height (B)	Overall Width (C)	
	BKT7X12X4	7-1/4"	12"	4"	
	BKT10X12X4	10"	12"	4"	
	BKT8X13	8"	13"	7-1/4"	
	BKT18X9X3	18"	9"	3"	
	BKT12X10 Recessed	12"	10-1/8"	7-1/4"	
	BKT18X10 Recessed	18"	10-1/8"	7-1/4"	
	BKT24X24X12 Recessed	24"	24"	12"	
	BKT14X16	14"	15-3/4"	4"	

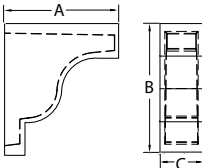

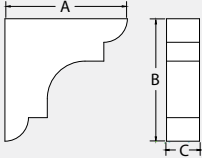
# Smooth Brackets

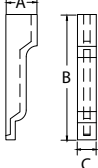

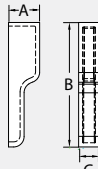







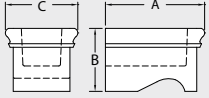

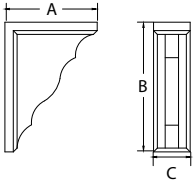
Cove / Arch

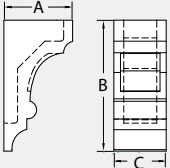
	Part Number	Projection (A)	Height (B)	Overall Width (C)	
	BKT18X24X3	18"	24"	3"	
	BKT22X26	22-1/2"	26"	8-1/2"	
	BKT13X13X3	13"	13"	3-1/2"	
	BKT5X20	5"	20"	3"	
	BKT6X24	6"	24"	4"	

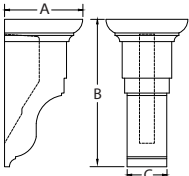
# Smooth Brackets

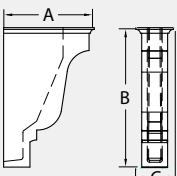

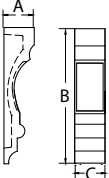

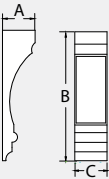





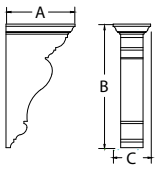

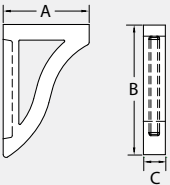

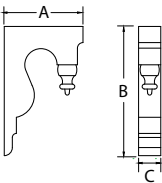
Decorative

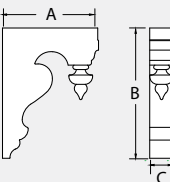
Decorative Millwork

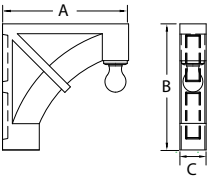
	Part Number	Projection (A)	Height (B)	Overall Width (C)	
	BKT5X8X6	7-7/8"	5"	5-3/4"	
	BKT9X13	9"	13"	3"	
	BKT11X15	11"	15"	3"	
	BKT5X10	5-1/4"	10"	4"	
	BKT8X15	7-7/8"	14-7/8"	8-1/4"	
	BKT11X16	10-1/2"	16-1/4"	4-3/8"	
	BKT4X18X4	4"	18"	4"	
	BKT6X24X6	6"	24"	6"	

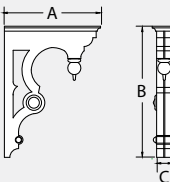
# Smooth Brackets

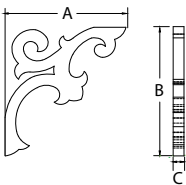

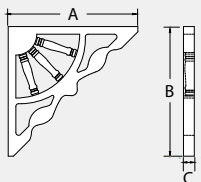







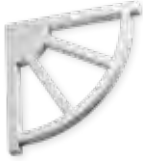
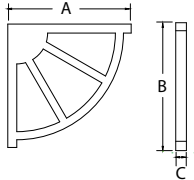

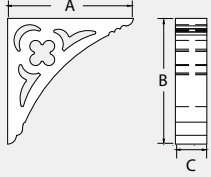

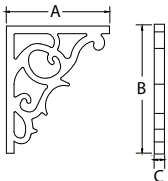
Decorative

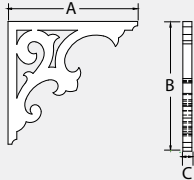
	Part Number	Projection (A)	Height (B)	Overall Width (C)	
	BKT15X28	15-3/8"	27-1/2"	8-3/8"	
	BKT11X17	11"	17"	2-7/8"	
	BKT10X16	9-3/4"	16"	2-3/4"	
	BKT12X17	12-1/8"	16-1/2"	3"	
	BKT24X24X5	24"	24"	5"	
	BKT22X30	22"	30"	5-1/2"	
	BKT12X12	12-1/4"	11-1/2"	1-1/8"	
	BKT12X12GP	12"	12"	1"	

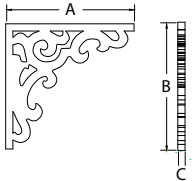

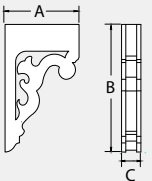
# Smooth Brackets

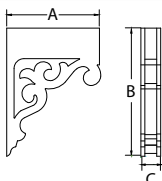
Decorative

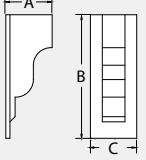
	Part Number	Projection (A)	Height (B)	Overall Width (C)	
	BKT12X12WW	12"	12"	1"	
	BKT12X12X3	12"	12"	3"	
	BKT22X21	21- <sup>3</sup> / <sub>4</sub> "	21- <sup>1</sup> / <sub>2</sub> "	3"	
	BKT10X12	10- <sup>1</sup> / <sub>8</sub> "	12- <sup>1</sup> / <sub>2</sub> "	1"	
	BKT14X15	14"	14- <sup>3</sup> / <sub>4</sub> "	1"	
	BKT19X20	19- <sup>1</sup> / <sub>2</sub> "	20"	1- <sup>1</sup> / <sub>8</sub> "	
	BKT12X21X3	12- <sup>1</sup> / <sub>4</sub> "	21- <sup>1</sup> / <sub>8</sub> "	3- <sup>1</sup> / <sub>4</sub> "	
	BKT16X23X3	16- <sup>3</sup> / <sub>8</sub> "	22- <sup>3</sup> / <sub>4</sub> "	3- <sup>1</sup> / <sub>2</sub> "	
	BKT11X30	11- <sup>1</sup> / <sub>4</sub> "	30"	11- <sup>1</sup> / <sub>4</sub> "	

# Smooth Brackets

Decorative

Decorative Millwork

	Part Number	Projection (A)	Height (B)	Overall Width (C)	
	BKT5X4	20-1/2"	4-3/8"	4-3/8"	
	BKT5X5X9	8-3/4"	5-3/8"	4-7/8"	
	BKT13X6	13-1/4"	5-3/4"	5-7/8"	
	BKT7X6X12	11-1/2"	6-3/4"	5-1/2"	
	BKT8X7X18	18"	7-3/8"	7"	
	BKT8X9X14	14"	8"	9"	













BKT10X14 is used with F100 to build up bracket detail in photo.

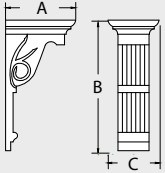

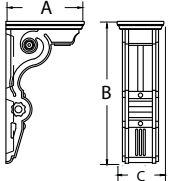

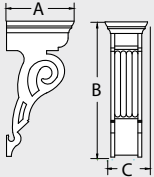





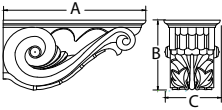

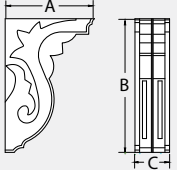

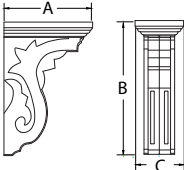
# Smooth Brackets

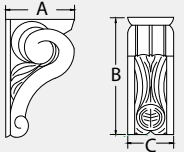
Ornate

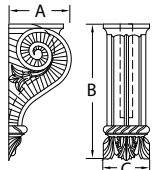
	Part Number	Projection (A)	Height (B)	Overall Width (C)	
	BKT11X20X8	11"	20-1/2"	8"	
	BKT23X26	22-1/2"	26"	8-1/2"	
	BKT18X35	17-1/2"	35"	11"	

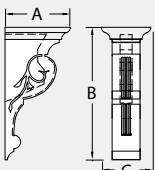
# Smooth Brackets

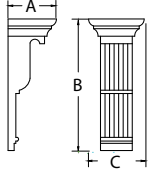

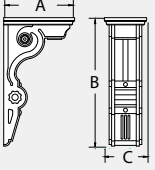



Ornate

	Part Number	Projection (A)	Height (B)	Overall Width (C)	
	BKT24X12	23-1/2"	11-1/2"	9-1/4"	
	BKT10X14	9-3/4"	14-1/2"	3-3/4"	
	BKT11X16X6	11"	16-1/4"	6"	
	BKT16X9	9-1/4"	15-7/8"	3-5/8"	
	BKT7X16	7-1/2"	16-1/4"	5-1/2"	
	BKT8X17	8-1/4"	16-5/8"	6-1/4"	
	BKT7X18	6-3/4"	18-1/4"	7-3/4"	
	BKT11X20X6	11"	20"	6-1/2"	
	BKT14X26	14-1/2"	26"	6-1/2"	

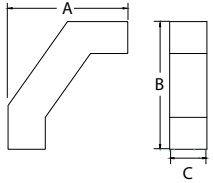
# Smooth Knee Braces

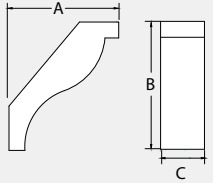

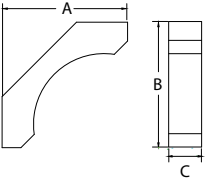

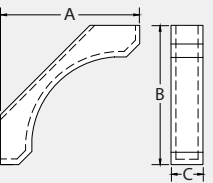

Flat

Decorative Millwork

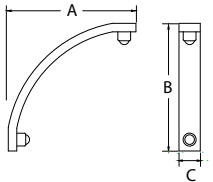
	Part Number	Projection (A)	Height (B)	Overall Width (C)	
	BKT11X12X3	11-1/4"	12"	3-1/2"	
	BKT13X15	12-1/2"	14-5/8"	5"	
	BKT14X14	13-1/4"	13-1/4"	3-1/2"	
	BKT30X30X8	30"	30"	6-7/8"	

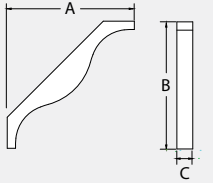

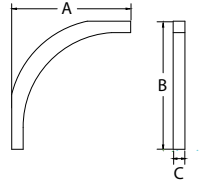

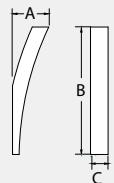





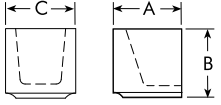

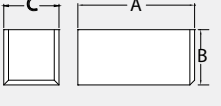

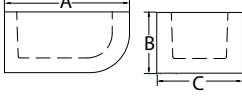
# Smooth Knee Braces

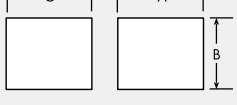
Decorative

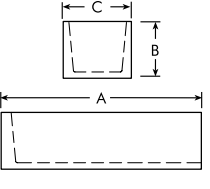
	Part Number	Projection (A)	Height (B)	Overall Width (C)	
	BKT15X15	15"	15"	2-1/2"	
	BKT22X22	22"	22"	2-3/4"	
	BKT26X28	26"	28"	2-1/2"	
	BKT8X29X4	8-1/4"	29"	4"	

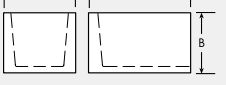
# Smooth Dentil Blocks

Flat

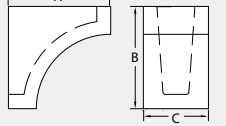
	Part Number	Projection (A)	Height (B)	Overall Width (C)	
	DTLB3X3X3	3-1/2"	3-1/2"	3-1/2"	
	DTLB3.5X3.5X7	7-3/8"	3-1/2"	3-1/2"	
	DTLB4X6X9	8-3/4"	4-1/4"	6"	
	DTLB5X6X6	6"	5"	6"	
	DTLB5X6X18	17-5/8"	5"	6"	
	DTLB5X6X8	8-1/2"	5"	6"	
	F100*	10-3/8"	5-1/2"	5"	
	DTLB5X5X3	5-1/2"	5-1/2"	3-1/2"	





\*See accessory block BKT10X14 on page 139.

Parts may be required to ship LTL (less than truckload) based on size and overall dimensions.

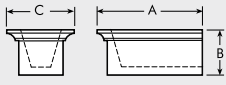

## Smooth Dentil Blocks

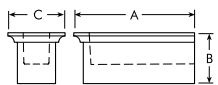
Decorative

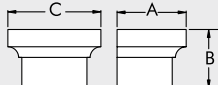
	Part Number	Projection (A)	Height (B)	Overall Width (C)	
	DTLB4X5X8	7- <sup>3</sup> / <sub>4</sub> "	3- <sup>3</sup> / <sub>8</sub> "	5"	
	DTLB5X6X10	9- <sup>1</sup> / <sub>2</sub> "	4- <sup>3</sup> / <sub>4</sub> "	5- <sup>7</sup> / <sub>8</sub> "	
	DTLB6X9X7	6- <sup>1</sup> / <sub>2</sub> "	5- <sup>1</sup> / <sub>2</sub> "	8- <sup>3</sup> / <sub>4</sub> "	

# Smooth Dentil Blocks











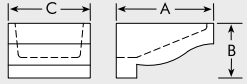

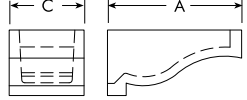

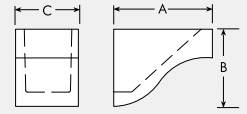

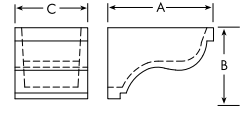
Decorative

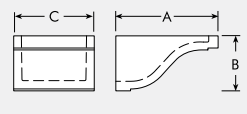
	Part Number	Projection (A)	Height (B)	Overall Width (C)	
	DTLB4X6X6	6-1/4"	4-1/2"	5-3/4"	
	DTLB6X6X9	9-3/8"	5-3/4"	5-1/2"	
	DTLB9X8X8	9"	8-1/8"	8-1/8"	
	DTLB6X7X9	9-1/4"	6"	7-1/4"	
	DTLB3X5X6	5-3/4"	3-1/8"	4-1/2"	
	DTLB4X4X9	9"	3-7/8"	4-3/8"	
	DTLB4X4X7	7-1/4"	4-3/8"	5"	
	DTLB5X8	5-7/16"	8-1/4"	4-13/16"	
	DTLB9X11X16	16"	9-1/4"	11-1/4"	

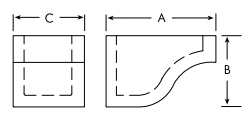
# Smooth Dentil Blocks

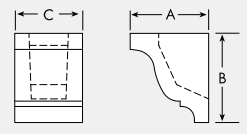
Assorted

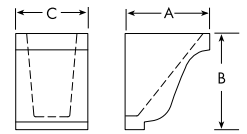
Decorative Millwork

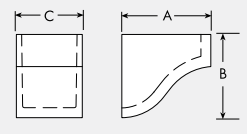
	Part Number	Projection (A)	Height (B)	Overall Width (C)	
	DTLB4X6X7	7-1/8"	4"	6"	
	DTLB5X6X11	10-3/4"	5-1/4"	6"	
	DTLB5X4X7	6-7/8"	5-3/8"	4-3/8"	
	DTLB6X6X8	8"	5-3/8"	5-1/2"	
	DTLB5X8X10	10"	5-3/8"	7-7/8"	
	DTLB6X6X9.25	9-1/4"	6"	6"	
	DTLB6X4X6	5-1/2"	6-1/8"	4-3/4"	
	DTLB6X6X5	5-1/2"	6-1/4"	4-3/4"	
	DTLB6X5X7	6-3/4"	6-5/16"	5"	





# Smooth Dentil Blocks









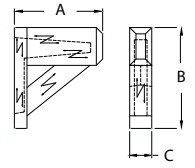

Assorted

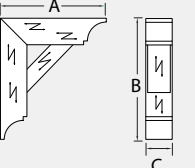
	Part Number	Projection (A)	Height (B)	Overall Width (C)		
	DTLB8X6X6	5- <sup>3</sup> / <sub>16</sub> "	8- <sup>1</sup> / <sub>8</sub> "	5- <sup>1</sup> / <sub>2</sub> "		
	DTLB3X3X4	4- <sup>1</sup> / <sub>2</sub> "	3- <sup>3</sup> / <sub>4</sub> "	3- <sup>3</sup> / <sub>4</sub> "		
	DTLB4X5X7	7- <sup>3</sup> / <sub>4</sub> "	4- <sup>1</sup> / <sub>4</sub> "	5- <sup>1</sup> / <sub>8</sub> "		
	DTLB4X4X4	4"	4"	4"		
	DTLB3.5X5.5X5.5	5- <sup>1</sup> / <sub>2</sub> "	3- <sup>1</sup> / <sub>2</sub> "	5- <sup>1</sup> / <sub>2</sub> "		
	Part Number	Projection (A)	Height (B)	Overall Width (C)	Pitch (D)	
	DTLB6X4X6R12	5- <sup>1</sup> / <sub>2</sub> "	11"	4- <sup>3</sup> / <sub>4</sub> "	12 / 12	
	DTLB6X4X6L12	5- <sup>1</sup> / <sub>2</sub> "	10- <sup>15</sup> / <sub>16</sub> "	4- <sup>3</sup> / <sub>4</sub> "	12 / 12	

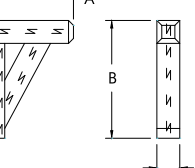
# Wood-Grained Brackets

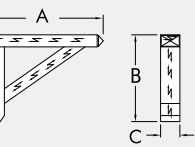
Flat

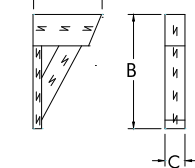
Decorative Millwork

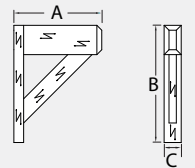
	Part Number	Projection (A)	Height (B)	Overall Width (C)	
	BKT14X16X3.5S	14"	16"	3-1/2"	
	BKT14X16X6S	14"	16"	5-1/2"	
	BKT22X24X4S-1	22"	24"	3-1/2"	
	BKT22X24X6S	22"	24"	5-1/2"	
	BKT26X24X6S	26"	24"	5-1/2"	
	BKT12X18X3X1S*	12"	18"	3-1/2"	
	BKT18X18X3X1S	18"	18"	3-1/2"	
	BKT24X18X4S	24"	18"	4"	
	BKT12X20X3S	12"	20"	3-1/2"	
	BKT18X24X3X2S	18"	24"	3-1/2"	

\*Only this size has a cavity.







Parts may be required to ship LTL (less than truckload) based on size and overall dimensions.

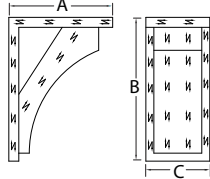

# Wood-Grained Brackets

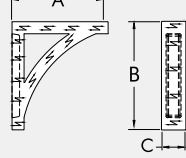
Cove / Arch

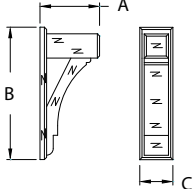
Decorative Millwork

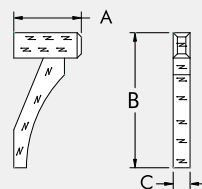
	Part Number	Projection (A)	Height (B)	Overall Width (C)	
	BKT13X18X8S	13"	18"	8"	
	BKT16X18X4S	16"	18"	4"	
	BKT14X30X7.5S	13-1/2"	30"	7-1/2"	
	BKT22X30X8S	21-1/2"	30"	7-1/2"	
	BKT16X32X4S	16"	32"	4"	





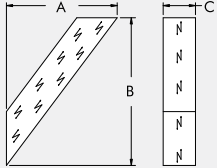

## Wood-Grained Knee Brace

Flat

	Part Number	Projection (A)	Height (B)	Overall Width (C)	
	BKTS18X24X6S	18"	24"	5-1/2"	

## Wood-Grained Knee Braces

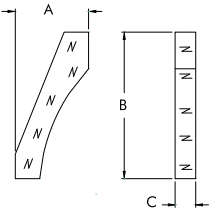

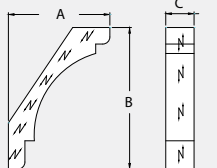



Cove / Arch

	Part Number	Projection (A)	Height (B)	Overall Width (C)	
	BKT12X24X3S	12"	24"	3-3/8"	
	BKTCV18X24X4S	18"	24"	3-1/4"	
	BKTCV18X24X6S	18"	24"	5-1/4"	
	BKTCV21X30X4S	21"	30"	3-1/4"	
	BKTCV21X30X6S	21"	30"	5-1/4"	
	BKT22X30X6S	21-1/2"	30"	6"	

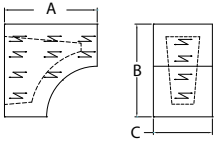
# Wood-Grained Corbels

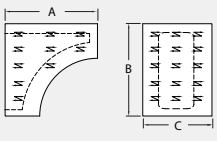
Cove

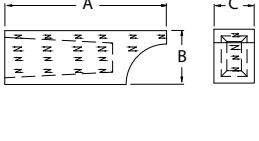
Decorative Millwork

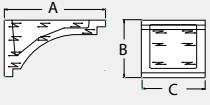
	Part Number	Projection (A)	Height (B)	Overall Width (C)	
	COR5X5X3S	5-1/2"	5-1/2"	3-1/2"	
	COR5X5S	5-1/2"	5-1/2"	5-1/2"	
	COR8X8X6S	8"	8"	6"	
	COR11X11X5S	11"	11"	5"	
	CORCV18X6X6S	18"	5-1/4"	5-1/4"	
	CORCV18X8X4S	18"	7-1/4"	3-1/4"	
	CORCV18X8X6S	18"	7-1/4"	5-1/4"	
	CORCV18X12X6S	18"	11-1/4"	5-1/4"	
	COR24X8X6S	24"	8"	6"	
	COR7X13X7S	13"	7-1/4"	7-1/2"	













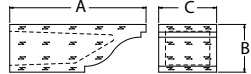

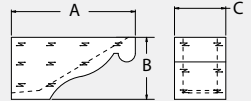
Note: Product has open cavity.  
Parts may be required to ship LTL (less than truckload) based on size and overall dimensions.

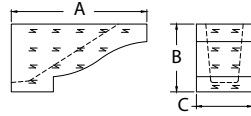

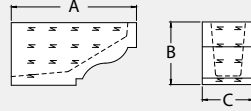
# Wood-Grained Corbels

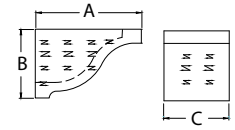
Scroll

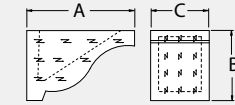
	Part Number	Projection (A)	Height (B)	Overall Width (C)	
	COROG24X6S	24"	5-7/8"	5-5/8"	
	COROG20X7S	20"	7"	8-1/2"	
	COROG15X7S	14-1/2"	7-1/4"	6"	
	COROGA15X7S	14-1/2"	7-1/4"	6"	
	COROGD15X7S	14-1/2"	7-1/4"	6"	
	COR7X11S	11-3/8"	7-3/8"	7"	
	COROG8X12S	11-3/8"	7-3/8"	7-3/8"	







Note: Product has open cavity.  
Parts may be required to ship LTL (less than truckload) based on size and overall dimensions.



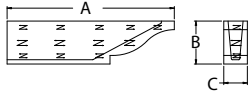

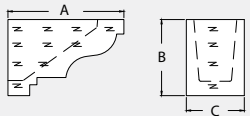

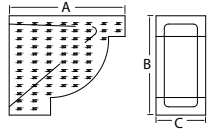

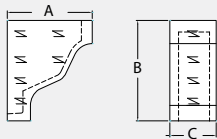





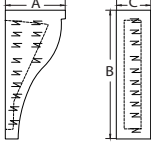

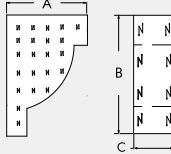

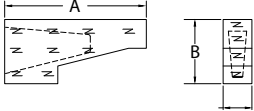
# Wood-Grained Corbels

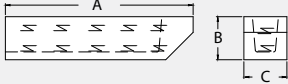
Scroll

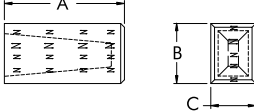
	Part Number	Projection (A)	Height (B)	Overall Width (C)	
	COR39X10X5.5S	39-1/4"	9-1/8"	5-1/2"	
	COR16X10X8S	16"	10-1/2"	8"	
	COR14X12X6S	14"	12"	6"	
	COR11X13X6S	11"	13"	6"	

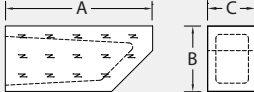
# Wood-Grained Corbels

Assorted

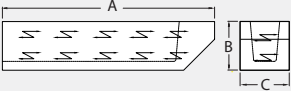
	Part Number	Projection (A)	Height (B)	Overall Width (C)	
	COR7X15X4S*	7"	15"	4"	
	COR12X18X6S	12"	18"	6"	
	COR16X7X3S*	16"	7-1/4"	3-1/4"	
	COR24X5X5S*	24"	5-1/2"	5-1/2"	
	COR16X8S*	16"	8"	6"	
	COR18X8X6S*	18"	8"	6"	
	COR18X9X3S*	18"	9"	3"	
	COR24X8X4S*	24"	8"	4"	

\*Product has open cavity.

Parts may be required to ship LTL (less than truckload) based on size and overall dimensions.



## How to Order

- ① Select profile design.
- ② Select size.
- ③ Optional: Select pitch angle needed.
- ④ Select pack quantity.\*

- Rafter tails are available in five profile designs: Straight, Cove, Slant, Bullnose and Scroll.
- Available in heights measuring 5-1/2" (6 nominal) and 7-1/2" (8 nominal).
- 6 Projections: 12", 18", 24", 30", 36", 42".
- Optional back cut pitch angles: 4/12, 6/12, 8/12, 10/12, 2/12.
- Quantities: 4 Pack, 10 Pack.

### Part Number Logic:

**BMRTSC4X6X24RSP8-4PK**

**[Profile]**  
 ST = Straight  
 CV = Cove  
 SL = Slant  
 BL = Bullnose  
 SC = Scroll

**[Width]**  
 4 = 4" (3-1/2" Actual)

**[Height]**  
 6 = 6" (5-1/2" Actual)  
 8 = 8" (7-1/2" Actual)

**[Projection]**  
 12 = 12"  
 18 = 18"  
 24 = 24"  
 30 = 30"  
 36 = 36"  
 42 = 42"

**[Pack Quantity]**  
 4PK = 4 Pack  
 10PK = 10 Pack

**[Optional Pitch]**  
 P4 = 4/12  
 P6 = 6/12  
 P8 = 8/12  
 P10 = 10/12  
 P12 = 12/12  
 (Blank) = No pitch

**4x6x24 Scroll Profile with Pitch**

**4x8x24 Scroll Profile without Pitch**

## Rafter Tails

Rough Sawn Wood Grain



Straight Profile (ST)	Cove Profile (CV)	Slant Profile (SL)	Bullnose Profile (BL)	Scroll Profile (SC)
BMRTST4X6X12RS-4PK	BMRTCV4X6X12RS-4PK	BMRTSL4X6X12RS-4PK	BMRTBL4X6X12RS-4PK	BMRTSC4X6X12RS-4PK
BMRTST4X6X18RS-4PK	BMRTCV4X6X18RS-4PK	BMRTSL4X6X18RS-4PK	BMRTBL4X6X18RS-4PK	BMRTSC4X6X18RS-4PK
BMRTST4X6X24RS-4PK	BMRTCV4X6X24RS-4PK	BMRTSL4X6X24RS-4PK	BMRTBL4X6X24RS-4PK	BMRTSC4X6X24RS-4PK
BMRTST4X6X30RS-4PK*	BMRTCV4X6X30RS-4PK*	BMRTSL4X6X30RS-4PK*	BMRTBL4X6X30RS-4PK*	BMRTSC4X6X30RS-4PK*
BMRTST4X6X36RS-4PK*	BMRTCV4X6X36RS-4PK*	BMRTSL4X6X36RS-4PK*	BMRTBL4X6X36RS-4PK*	BMRTSC4X6X36RS-4PK*
BMRTST4X6X42RS-4PK*	BMRTCV4X6X42RS-4PK*	BMRTSL4X6X42RS-4PK*	BMRTBL4X6X42RS-4PK*	BMRTSC4X6X42RS-4PK*
BMRTST4X8X18RS-4PK	BMRTCV4X8X18RS-4PK	BMRTSL4X8X18RS-4PK	BMRTBL4X8X18RS-4PK	BMRTSC4X8X18RS-4PK
BMRTST4X8X24RS-4PK	BMRTCV4X8X24RS-4PK	BMRTSL4X8X24RS-4PK	BMRTBL4X8X24RS-4PK	BMRTSC4X8X24RS-4PK
BMRTST4X8X30RS-4PK*	BMRTCV4X8X30RS-4PK*	BMRTSL4X8X30RS-4PK*	BMRTBL4X8X30RS-4PK*	BMRTSC4X8X30RS-4PK*
BMRTST4X8X36RS-4PK*	BMRTCV4X8X36RS-4PK*	BMRTSL4X8X36RS-4PK*	BMRTBL4X8X36RS-4PK*	BMRTSC4X8X36RS-4PK*
BMRTST4X8X42RS-4PK*	BMRTCV4X8X42RS-4PK*	BMRTSL4X8X42RS-4PK*	BMRTBL4X8X42RS-4PK*	BMRTSC4X8X42RS-4PK*

\*Rafter tails over 24" long are only available in pack quantities of 4.



Note: All parts have open cavity.

Parts may be required to ship LTL (less than truckload) based on size and overall dimensions.

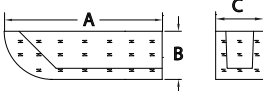

## Rafter Tails

Standard Wood Grain

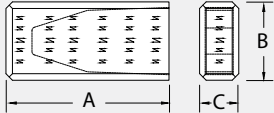
	Part Number	Length (A)	Height (B)	Overall Width (C)	
	BMRTS6X4X24S	24"	3-1/4"	5-1/4"	
	BMRTS8X4X24S	24"	7-1/4"	3-1/4"	
	BMCRT25X12X6S	25"	12"	6"	

## Rafter Tails



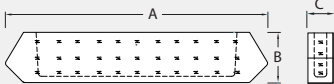

Double-Ended, Standard Wood Grain

	Part Number	Length (A)	Height (B)	Overall Width (C)	
	BMRT4X8X42S	42"	8"	4"	

# Smooth Trellis System



Trellis Kit Part Number & Contents	Overall Width (Installed)	Overall Height (Installed)	Projection (Installed)
<b>TRLS19003</b> Fits 16'-18' Garage Doors (2) BKT32X31X5, <i>Outlooker</i> (4) BMD4X8X144, <i>12' Beam</i> (18) FLTBA36X3X3, <i>Rafter Tail</i> (1) TRLS18989, <i>Hardware Kit</i>	21' 9" <i>Over 16' Door</i>  23' 9" <i>Over 18' Door</i>	41- <sup>7</sup> / <sub>8</sub> "	36"
<b>TRLS19004</b> Fits 8'-9' Garage Doors (2) BKT32X31X5, <i>Outlooker</i> (2) BMD4X8X48, <i>4' Beam</i> (2) BMD4X8X144, <i>12' Beam</i> (10) FLTBA36X3X3, <i>Rafter Tail</i> (1) TRLS18994, <i>Hardware Kit</i>	13' 9" <i>Over 8' Door</i>  14' 9" <i>Over 9' Door</i>	41- <sup>7</sup> / <sub>8</sub> "	36"

Individual Trellis Components	Part Number	Projection	Height	Overall Width
	BKT32X31X5 Outlooker	32- <sup>1</sup> / <sub>2</sub> "	30- <sup>5</sup> / <sub>8</sub> "	5- <sup>1</sup> / <sub>4</sub> "
	BMD4X8X48* Beam	4- <sup>1</sup> / <sub>4</sub> "	7- <sup>3</sup> / <sub>4</sub> "	48"
Scrolled profile on one end only.	BMD4X8X144* Beam	4- <sup>1</sup> / <sub>2</sub> "	7- <sup>3</sup> / <sub>4</sub> "	144"
	FLTBA36X3X3* Lattice	36"	3- <sup>1</sup> / <sub>2</sub> "	2- <sup>3</sup> / <sub>4</sub> "
Angled on one end only.				
	TRLS18989 Hardware Kit for TRLS19003	<b>Kit Contains:</b> (3) Angle Bracket (3) U Bracket (1) HDW Pack** (1) Installation Guide	—	—
	TRLS18994 Hardware Kit for TRLS19004	<b>Kit Contains:</b> (2) Angle Bracket (2) U Bracket (1) HDW Pack** (1) Installation Guide	—	—

\*This product is not finished on all sides.

\*\*HDW pack contains: lock washers, hex nuts and bolts.

For installation instructions, visit [fypon.com](http://fypon.com).





Parts may be required to ship LTL (less than truckload) based on size and overall dimensions

# Wood-Grained Trellis System



Trellis Kit Part Number & Contents	Overall Width (Installed)	Overall Height (Installed)	Projection (Installed)
<b>TRLS18987</b> Fits 16'-18' Garage Doors (2) BKT32X31X5S, <i>Outlooker</i> (4) BMD4X8X144S, <i>12' Beam</i> (18) FLTBA36X3X3S, <i>Rafter Tail</i> (1) TRLS18989, <i>Hardware Kit</i>	21' 9" <i>Over 16' Door</i>  23' 9" <i>Over 18' Door</i>	41-7/8"	36"

<b>TRLS18988</b> Fits 8'-9' Garage Doors (2) BKT32X31X5S, <i>Outlooker</i> (2) BMD4X8X48S, <i>4' Beam</i> (2) BMD4X8X144S, <i>12' Beam</i> (10) FLTBA36X3X3S, <i>Rafter Tail</i> (1) TRLS18994, <i>Hardware Kit</i>	13' 9" <i>Over 8' Door</i>  14' 9" <i>Over 9' Door</i>	41-7/8"	36"
---	--	---------	-----

Individual Trellis Components	Part Number	Projection	Height	Overall Width
	BKT32X31X5S Outlooker	32-1/2"	30-5/8"	5-1/4"
	BMD4X8X48S^* Beam	4-1/4"	7-3/4"	48"
Scrolled profile on one end only.	BMD4X8X144S* Beam	4-1/4"	7-3/4"	144"
	FLTBA36X3X3S* Lattice	36"	3-1/2"	2-3/4"
Angled on one end only.	TRLS18989 Hardware Kit for TRLS18987	<b>Kit Contains:</b> (3) Angle Bracket (3) U Bracket (1) HDW Pack** (1) Installation Guide	—	—
	TRLS18994 Hardware Kit for TRLS18988	<b>Kit Contains:</b> (2) Angle Bracket (2) U Bracket (1) HDW Pack** (1) Installation Guide	—	—

# Smooth Beam



W x H Nominal Dimensions	Actual Dimensions*	Side Wall Thickness*	Inside Top Width*	Inside Bottom Width*
4" x 4"	3-1/2" x 3-1/2"	3/4"	2"	1-1/2"
4" x 6"	3-1/2" x 5-1/2"	3/4"	2"	1-1/2"
6" x 8"	5-1/2" x 7-1/2"	3/4"	4"	3-1/2"
8" x 10"	7-1/2" x 9-1/2"	3/4"	6"	5-1/2"

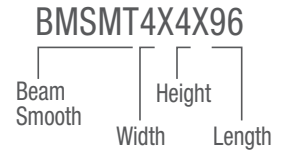

Note: Width and height are nominal, length is actual.

Note: Beam inside dimensions are 1-1/4" wider to accommodate a standard 2" x 2", 2" x 4", 2" x 6", 2" x 8" blocking application. \* +/- 1/4"

4" x 4" Part Number	4" x 6" Part Number	6" x 8" Part Number	8" x 10" Part Number
BMSMT4X4X96	BMSMT4X6X96	BMSMT6X8X96	BMSMT8X10X96
BMSMT4X4X120	BMSMT4X6X120	BMSMT6X8X120	BMSMT8X10X120
BMSMT4X4X144	BMSMT4X6X144	BMSMT6X8X144	BMSMT8X10X144
BMSMT4X4X168	BMSMT4X6X168	BMSMT6X8X168	BMSMT8X10X168
BMSMT4X4X192	BMSMT4X6X192	BMSMT6X8X192	BMSMT8X10X192
BMSMT4X4X216	BMSMT4X6X216	BMSMT6X8X216	BMSMT8X10X216
BMSMT4X4X240	BMSMT4X6X240	BMSMT6X8X240	BMSMT8X10X240

Decorative Millwork











# Smooth Classic Beam

	Part Number	Overall Width (A)	Overall Height (B)	Length (C)	Inside Width	Inside Height	
	BM4X5X192	6- <sup>5</sup> / <sub>8</sub> "	5"	16'	2"	4"	



# Beam - Rough Sawn

Cedar



W x H Nominal Dimensions	Actual Dimensions*	Side Wall Thickness*	Inside Top Width*	Inside Bottom Width*
4" x 6"	3-1/2" x 5-1/2"	3/4"	2"	1-5/8"
6" x 8"	5-1/2" x 7-1/2"	3/4"	4"	3-1/2"
8" x 10"	7-1/2" x 9-1/2"	3/4"	6"	5-3/8"

Note: Beam inside dimensions are 1-1/4" wider to accommodate a standard 2" x 2", 2" x 4", 2" x 6", 2" x 8" blocking application. \* +/- 1/4"

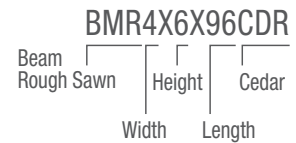

Note: Width and height are nominal, length is actual.

4" x 6" Part Number	6" x 8" Part Number	8" x 10" Part Number	Additional Sizes
BMR4X6X96CDR	BMR6X8X96CDR	BMR8X10X96CDR	Available in 24" increments, from 96" to 288".  See price pages for individual part numbers.
BMR4X6X144CDR	BMR6X8X144CDR	BMR8X10X144CDR	
BMR4X6X192CDR	BMR6X8X192CDR	BMR8X10X192CDR	
BMR4X6X240CDR	BMR6X8X240CDR	BMR8X10X240CDR	
BMR4X6X288CDR	BMR6X8X288CDR	BMR8X10X288CDR	

Decorative Millwork



Rough Sawn



# Beam - Hand Hewn

Elm



W x H Nominal Dimensions	Actual Dimensions*	Side Wall Thickness*	Inside Top Width*	Inside Bottom Width*
4" x 6"	3-1/2" x 5-1/2"	3/4"	2"	1-5/8"
6" x 8"	5-1/2" x 7-1/2"	3/4"	4"	3-1/2"
8" x 10"	7-1/2" x 9-1/2"	3/4"	6"	5-3/8"

Note: Beam inside dimensions are 1-1/4" wider to accommodate a standard 2" x 2", 2" x 4", 2" x 6", 2" x 8" blocking application.

\* +/- 1/4"

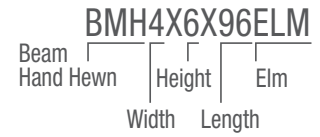

Note: Width and height are nominal, length is actual.

4" x 6" Part Number	6" x 8" Part Number	8" x 10" Part Number	Additional Sizes
BMH4X6X96ELM	BMH6X8X96ELM	BMH8X10X96ELM	Available in 24" increments, from 96" to 288".  See price pages for individual part numbers.
BMH4X6X144ELM	BMH6X8X144ELM	BMH8X10X144ELM	
BMH4X6X192ELM	BMH6X8X192ELM	BMH8X10X192ELM	
BMH4X6X240ELM	BMH6X8X240ELM	BMH8X10X240ELM	
BMH4X6X288ELM	BMH6X8X288ELM	BMH8X10X288ELM	

Decorative Millwork



Hand Hewn



# Beam - Mesa

Redwood



W x H Nominal Dimensions	Actual Dimensions*	Side Wall Thickness*	Inside Top Width*	Inside Bottom Width*
4" x 6"	3-1/2" x 5-1/2"	3/4"	2"	1-5/8"
6" x 8"	5-1/2" x 7-1/2"	3/4"	4"	3-1/2"
8" x 10"	7-1/2" x 9-1/2"	3/4"	6"	5-3/8"
10" x 15"	9-1/8" x 14-3/4"	3/4"	7-5/8"	6-5/8"

Note: Beam inside dimensions are 1-1/4" wider to accommodate a standard 2" x 2", 2" x 4", 2" x 6", 2" x 8" blocking application.

\* +/-1/4"

**BMM4X6X96RDW**



Note: Width and height are nominal, length is actual.

4" x 6" Part Number	6" x 8" Part Number	8" x 10" Part Number	10" x 15" Part Number	Additional Sizes
BMM4X6X96RDW	BMM6X8X96RDW	BMM8X10X96RDW	BMM10X15X234RDW**	Available in 24" increments, from 96" to 288".  See price pages for individual part numbers.
BMM4X6X144RDW	BMM6X8X144RDW	BMM8X10X144RDW		
BMM4X6X192RDW	BMM6X8X192RDW	BMM8X10X192RDW		
BMM4X6X240RDW	BMM6X8X240RDW	BMM8X10X240RDW		
BMM4X6X288RDW	BMM6X8X288RDW	BMM8X10X288RDW		

Decorative Millwork



\*\*Only available in 234". Refer to Beam Freight Policy in Pricebook.





# Beam - Tahoe

Cedar



W x H Nominal Dimensions	Actual Dimensions*	Side Wall Thickness*	Inside Top Width*	Inside Bottom Width*
4" x 6"	3-1/2" x 5-1/2"	3/4"	2"	1-5/8"
6" x 8"	5-1/2" x 7-1/2"	3/4"	4"	3-1/2"
8" x 10"	7-1/2" x 9-1/2"	3/4"	6"	5-3/8"

Note: Beam inside dimensions are 1-1/4" wider to accommodate a standard 2" x 2", 2" x 4", 2" x 6", 2" x 8" blocking application. \* +/- 1/4"

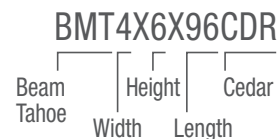

Note: Width and height are nominal, length is actual.

4" x 6" Part Number	6" x 8" Part Number	8" x 10" Part Number	Additional Sizes
BMT4X6X96CDR	BMT6X8X96CDR	BMT8X10X96CDR	Available in 24" increments, from 96" to 288".  See price pages for individual part numbers.
BMT4X6X144CDR	BMT6X8X144CDR	BMT8X10X144CDR	
BMT4X6X192CDR	BMT6X8X192CDR	BMT8X10X192CDR	
BMT4X6X240CDR	BMT6X8X240CDR	BMT8X10X240CDR	
BMT4X6X288CDR	BMT6X8X288CDR	BMT8X10X288CDR	

Decorative Millwork





## Beam - Milled

Smooth Cedar



Part Number	Overall Width	Overall Height	Length	Inside Width	Inside Height
BMCDR8X6X168S	7-1/4"	5-3/4"	14'	5-3/4"	5"

# Beam Mantel - Hand Hewn

Elm



**Sizes:**

- Available in 6" x 8" and 8" x 10" (projection x height) with lengths measuring 60" - 90", in 6" increments.



**Part Number**

- BMH6X8X60ELM-EC
- BMH6X8X66ELM-EC
- BMH6X8X72ELM-EC
- BMH6X8X78ELM-EC
- BMH6X8X84ELM-EC
- BMH6X8X90ELM-EC
- BMH8X10X60ELM-EC
- BMH8X10X66ELM-EC
- BMH8X10X72ELM-EC
- BMH8X10X78ELM-EC
- BMH8X10X84ELM-EC
- BMH8X10X90ELM-EC



# Beam Mantel - Rough Sawn

Cedar



**Part Number**

- BMR6X8X60CDR-EC
- BMR6X8X66CDR-EC
- BMR6X8X72CDR-EC
- BMR6X8X78CDR-EC
- BMR6X8X84CDR-EC
- BMR6X8X90CDR-EC
- BMR8X10X60CDR-EC
- BMR8X10X66CDR-EC
- BMR8X10X72CDR-EC
- BMR8X10X78CDR-EC
- BMR8X10X84CDR-EC
- BMR8X10X90CDR-EC

# Beam Top

Mesa



Beam with top shown.

Part Number	Nominal	Actual
BTM6X144*	6" x 1" x 144"	5-1/2" x 3/4" x 144"
BTM8X144*	8" x 1" x 144"	7-1/2" x 3/4" x 144"

# Beam End Cap





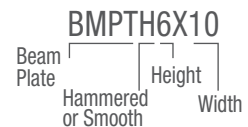

Beam with end cap shown.

Part Number	Nominal	Actual
BC10X15	10" x 15" x 1"	9-1/8" x 15-5/8" x 3/4"

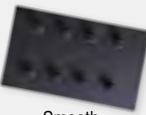
# Beam Plates

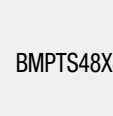

	Smooth	Hammered		Smooth	Hammered	
	Part Number	Part Number		Part Number	Part Number	
 Smooth   Hammered	BMPTS6X10	BMPTH6X10	 Smooth   Hammered	BMPTS36X36 <sup>†</sup>	BMPTH36X36 <sup>†</sup>	
	BMPTS8X10	BMPTH8X10		 Smooth   Hammered	BMPTS48X48 <sup>†</sup>	BMPTH48X48 <sup>†</sup>
	BMPTS10X15	BMPTH10X15				
	BMPTS15X20	BMPTH15X20				

Note: Nuts and bolts molded into the beam plate. Quantity is dependent on size of the plate.  
Note: 4 parts per package (2 front and 2 back plates).

<sup>†</sup> Beam plate can be cut to fit your specific project requirement. Nut and bolt heads are shipped unattached (20 each).

Note: Nut and bolt heads are included (20 of each packaged separately).  
Additional packs can be ordered separately (BMPLTHDWKT40 = 20 nuts and 20 bolts, BMPLTHDWKT20 = 10 nuts and 10 bolts, BMPLTHDWKT10 = 5 nuts and 5 bolts).

# Beam Straps

	Smooth		Hammered	
	Part Number	Beam Size	Part Number	Beam Size
	BMSTRPS4X6	4" x 6"	BMSTRPH4X6	4" x 6"
	BMSTRPS6X8	6" x 8"	BMSTRPH6X8	6" x 8"
	BMSTRPS8X10	8" x 10"	BMSTRPH8X10	8" x 10"
	BMSTRPS10X15	10" x 15"	BMSTRPH10X15	10" x 15"

Note: Beam straps sold as set of 2.  
Parts may be required to ship LTL (less than truckload) based on size and overall dimensions.



## Gable Pediments

Victorian Style

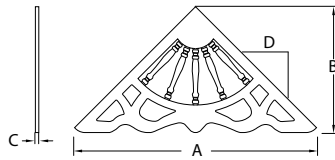

Part Number	Overall Width (A)	Overall Height (B)	Projection (C)	Pitch (D)
GP64X32	62"	32- <sup>1</sup> / <sub>4</sub> "	1"	12 / 12
GP80X33	80- <sup>1</sup> / <sub>4</sub> "	33- <sup>3</sup> / <sub>4</sub> "	1"	10 / 12
GP81X31	81- <sup>1</sup> / <sub>4</sub> "	31- <sup>1</sup> / <sub>4</sub> "	1"	9 / 12
GP88X29	86- <sup>3</sup> / <sub>8</sub> "	29- <sup>3</sup> / <sub>8</sub> "	1"	8 / 12
GP96X28	96"	28"	1"	7 / 12
GP107X22	107"	22"	1"	5 / 12
GP110X27	106- <sup>7</sup> / <sub>8</sub> "	27- <sup>3</sup> / <sub>8</sub> "	1"	6 / 12

## Gable Pediments

Arched Style

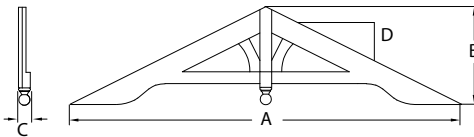

Part Number	Overall Width (A)	Overall Height (B)	Projection (C)	Pitch (D)
GPA70X35	70"	35"	3- <sup>1</sup> / <sub>4</sub> "	12 / 12
GPA81X34	80- <sup>1</sup> / <sub>2</sub> "	33- <sup>1</sup> / <sub>2</sub> "	3- <sup>1</sup> / <sub>4</sub> "	10 / 12
GPA86X32	85- <sup>1</sup> / <sub>4</sub> "	32- <sup>1</sup> / <sub>4</sub> "	3- <sup>1</sup> / <sub>4</sub> "	9 / 12
GPA87X29	86- <sup>7</sup> / <sub>8</sub> "	29"	3- <sup>1</sup> / <sub>4</sub> "	8 / 12
GPA95X28	95- <sup>1</sup> / <sub>4</sub> "	27- <sup>3</sup> / <sub>4</sub> "	3- <sup>1</sup> / <sub>4</sub> "	7 / 12
GPA104X26	103- <sup>1</sup> / <sub>2</sub> "	25- <sup>7</sup> / <sub>8</sub> "	3- <sup>1</sup> / <sub>4</sub> "	6 / 12

# Gable Pediments

Flat Style

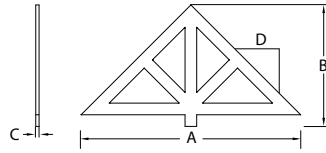

Part Number	Overall Width (A)	Overall Height (B)	Projection (C)	Pitch (D)
GPF66X33	66"	36-1/2"	1"	12 / 12

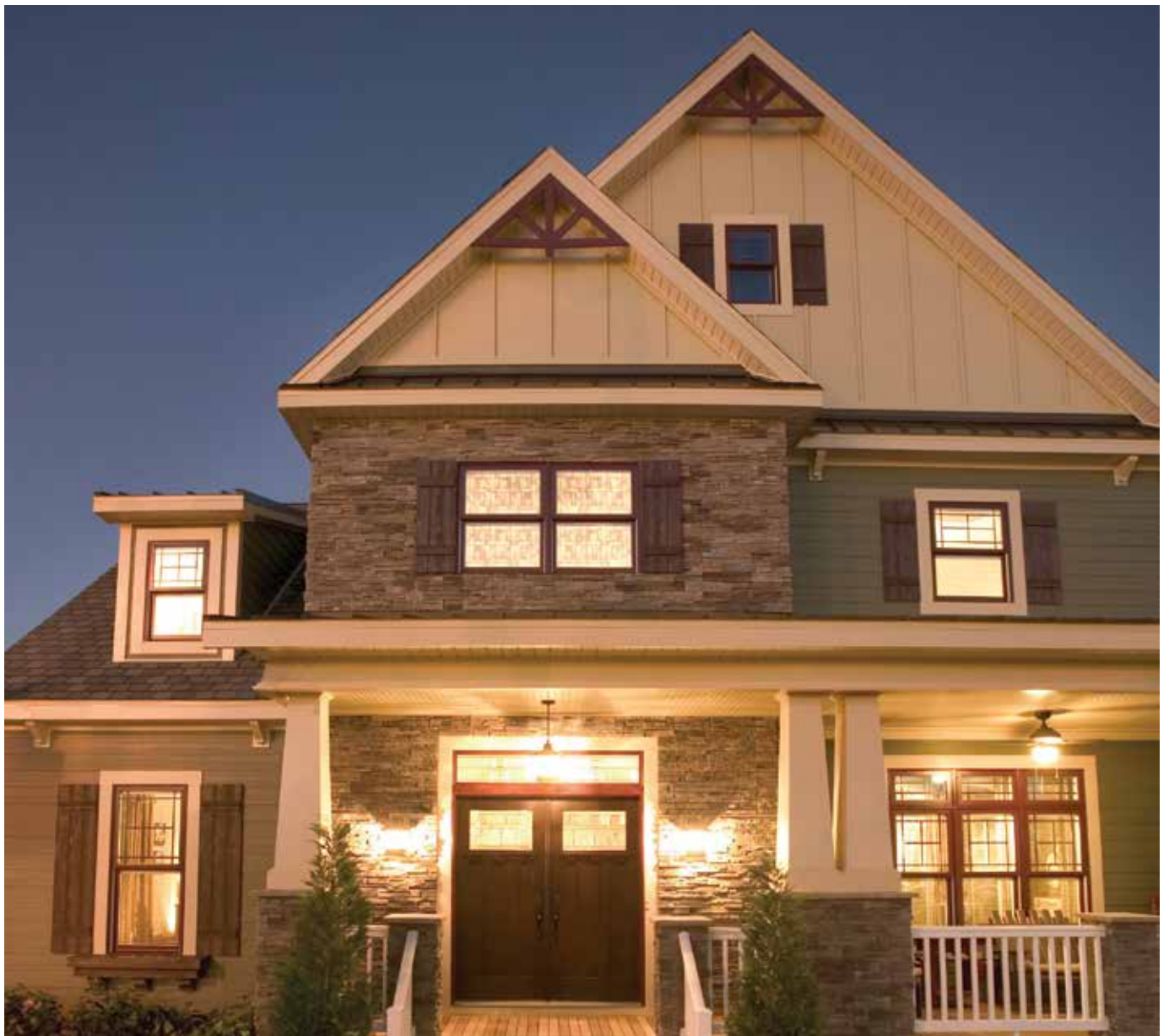



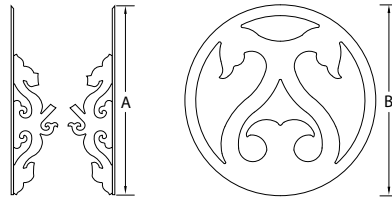

## Gable Pediment Kits

Stewart System



	Part Number	Rake Length (A) (Each Side)	Pitch	Accessories
	GPK401	39-1/4"	Adjustable from 5 / 12 to 14 / 12 pitch	GPK451
	GPK801	77-1/2"	Adjustable from 5 / 12 to 14 / 12 pitch	GPK851
	Part Number	Diameter (B)	Pitch	Accessories
	GPK451	16"	—	GPK401
	GPK851	32-1/8"	—	GPK801

Note: GPK401 and GPK801 kits include adhesive and screws.

## Gable Pediment Kits

Basic System

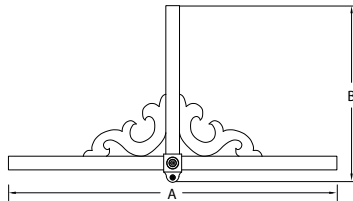

Part Number	Base Width (A)	Overall Height (B)	Thickness	Pitch
GPK100	96"	51-5/8"	1-1/4"	Adjustable from 6 / 12 to 12 / 12

Note: Ships in 6 pieces; field trimming and assembly required. Installation hardware and instructions included.



# Ceiling Medallions

One Piece

	Part Number	Diameter / Width	Projection	Center Opening Diameter
	CM15BM Beaumont	14- <sup>3</sup> / <sub>8</sub> "	2- <sup>1</sup> / <sub>4</sub> "	1"
	CM16FL Florentine	16"	1- <sup>1</sup> / <sub>8</sub> "	4- <sup>1</sup> / <sub>8</sub> "
	CM24RN Randolph	24- <sup>3</sup> / <sub>8</sub> "	1- <sup>1</sup> / <sub>2</sub> "	1"
	CM36NI Nicolas	35- <sup>3</sup> / <sub>4</sub> "	2"	2"
	CM67WT Whitney	67- <sup>1</sup> / <sub>2</sub> " Width 43- <sup>1</sup> / <sub>2</sub> " Height	1"	4- <sup>3</sup> / <sub>8</sub> "



Decorative Millwork

# Ceiling Medallions

Two Piece

	Part Number	Diameter / Width	Projection	Center Opening Diameter
	CM16FL2 Florentine	15- <sup>3</sup> / <sub>4</sub> "	1- <sup>1</sup> / <sub>8</sub> "	5- <sup>5</sup> / <sub>8</sub> "
	CM16JE2 Jefferson	15- <sup>1</sup> / <sub>2</sub> "	3/4"	5- <sup>3</sup> / <sub>4</sub> "





# Decorative Panels

	Part Number	Width / Height (A, B)	Projection (C)
	<p>DP28X28SQX Square</p>	<p>28"</p>	<p>1-1/4"</p> 

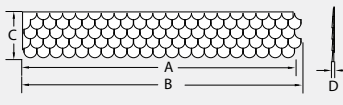

# Fishscale Panel

Round Scales

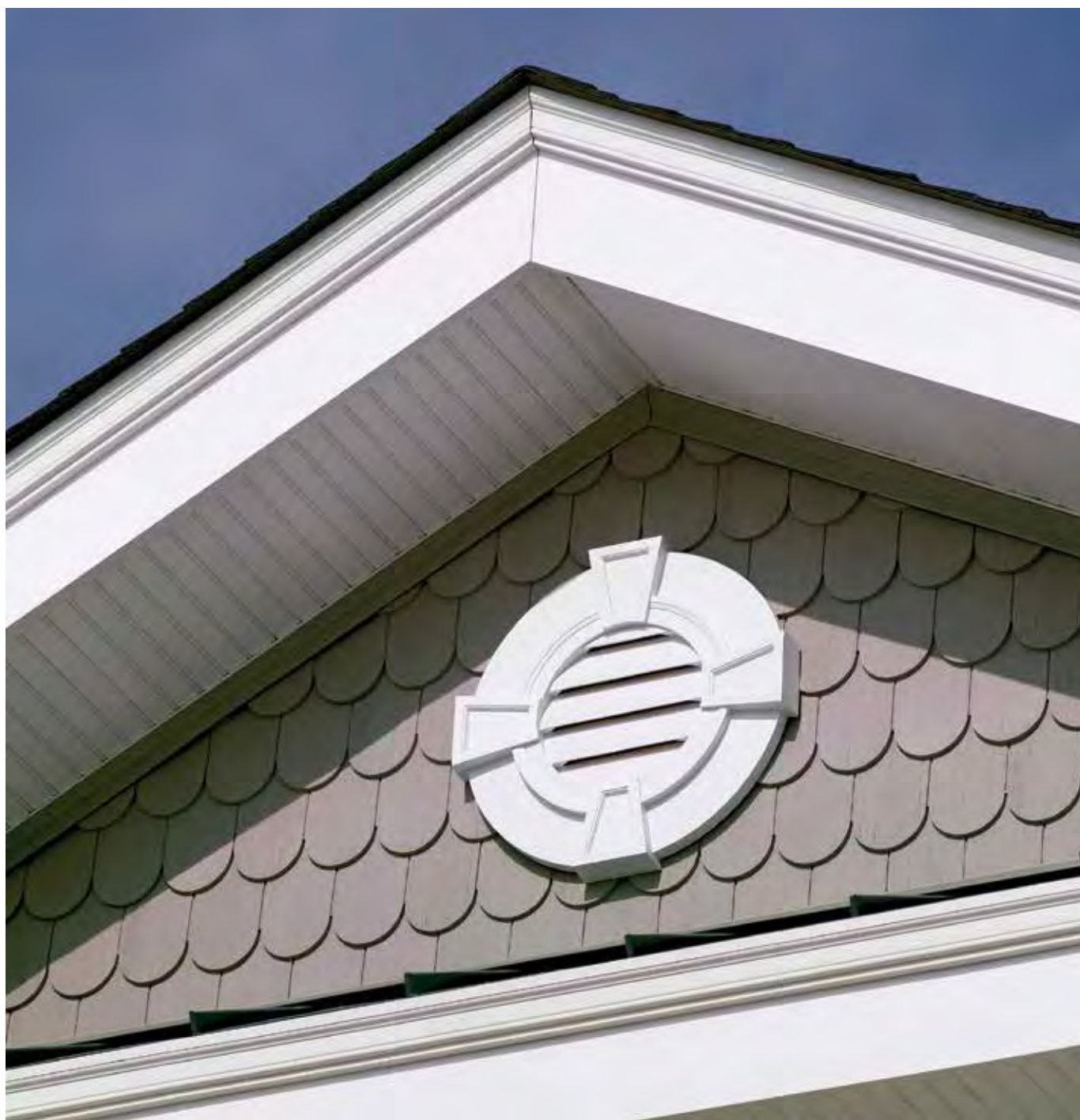
	Part Number	Length (A)	Overall Length (B)	Height (C)	Projection (D)
	FSR103X17	98-5/8"	101-5/8"	16-1/4"	3/4"
					



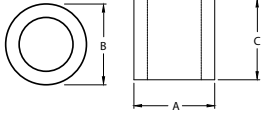

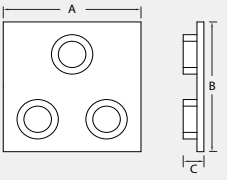
# Tile Vents

	Part Number	Width (A)	Height (B)	Projection (C)	
	CN6X6	6"	6"	6"	
	TV20X20-3FR	20"	19-3/4"	3-1/2"	





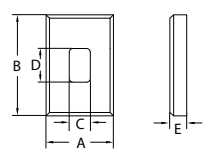

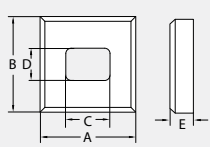

## Fixture Mounts

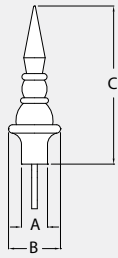

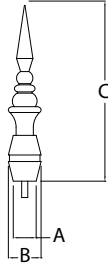

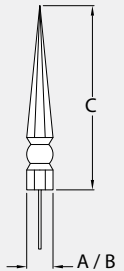





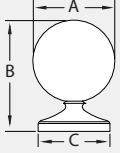

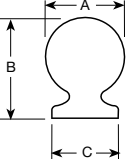
	Part Number	Width (A)	Height (B)	Inside Width (C)	Inside Height (D)	Projection (E)	
	FM8X12X2 Vertical	8"	12"	2-1/2"	4"	2"	
	FMS8X8X2 Square	8"	8"	3-3/4"	2-3/4"	2"	

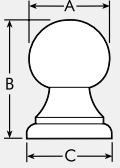
# Spires

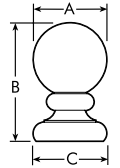
	Part Number	Base Diameter (A)	Diameter (B)	Height (C)	Anchoring Pipe	
	S4X21	3-1/2"	7"	21-1/4"	3/4" x 6"	
	S6X32	4-1/4"	6"	32-1/4"	1-1/8" x 3"	
	S8X56	8"	8"	56"	1-1/8" x 18"	

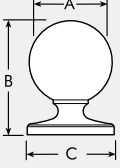

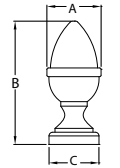
# Full-Round Finial

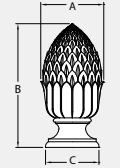
	Part Number	Ball Diameter (A)	Height (B)	Base Diameter (C)	
	B4X6	4"	5-1/2"	3-1/2"	
	B5X7	5-1/4"	6-3/4"	4-3/8"	
	B6X8	5-7/8"	7-3/4"	5-7/8"	
	B6X9	7"	9"	5-7/8"	
	B8X10	8"	10"	8-1/4"	
	B10X13	10"	12-7/8"	8 1/2"	
	B12X16	12"	16"	12"	
	B3X4 Pedestal Ball	3-1/8"	4-5/8"	3-1/4"	
	B3X5 Post Ball	3-1/4"	5-1/4"	3-1/4"	
	B7X9 Decorative Ball	6-1/4"	8-1/2"	6-1/2"	
	AFR10 Acorn	4-7/8"	11-1/8"	4-1/2"	
	PHFR5X11 Pineapple	5-5/8"	11"	4-3/4"	
	PHFR6X14 Pineapple	7-1/8"	14"	6-1/8"	

# Louvers & Gable Vents



## HISTORIC STYLE FOR ANY HOME.

Fypon offers a diverse assortment of decorative, non-venting and functional, venting louvers to complement most architectural home styles. Decorative louvers feature a solid, one-piece design that does not allow air to pass through. Functional louvers are designed to provide additional ventilation, with angled slats and screening to help protect interiors from the elements.





Cathedral Louver .....	188
Eyebrow Louver.....	189
Peaked Louver .....	189
Vertical Louver .....	190
Horizontal Louver .....	193
Half-Round Louver .....	194
Round Louver .....	196
Oval Louver .....	198
Triangle Louver .....	200
Two-Piece Triangle Louver .....	201
Diamond Louver .....	202
Octagon Louver.....	202

**Product Shown:**  
Triangle Louver  
Rectangle Louver  
Flat Trim  
Crosshead with Bottom Trim



# Louvers & Gable Vents

---

## HOW TO USE THIS SECTION

The products in this section of the catalog are organized by louver style followed by matching trim. Where applicable, matching keystones are referenced for each louver and trim piece.

---

## HOW TO ORDER

### Functional Louvers

If you are ordering a functional louver, you should order a louver that is approximately 2" larger than your rough opening on all sides. This will allow you to attach the louver to the substrate through the brickmould edge. Functional louvers are slatted for air flow with a screen on the back. Note: Slats are not operable.

### Louver Accessories

Keystones and trim are available attached to standard products as fabricated items. Keystones and trim can also be ordered as unattached accessories by listing the matching part number as a separate line item on your order.





## LOUVER KEYSTONE APPLICATIONS

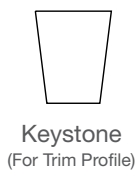
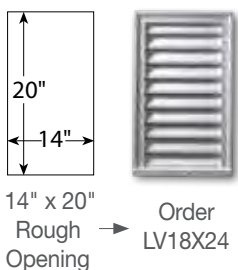

# Cathedral Louver

Brickmould Style



Cathedral Louver



4F Flat Trim

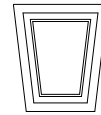

Keystone  
Page 55  
KWM180M

Louver Decorative Part Number	Width	Height	Louver Functional Part Number	Vent Area	Louver Trim
CLV12X24	12"	24"	FCLV12X24	10 Sq. In.	—
CLV14X22	14"	22"	FCLV14X22	14 Sq. In.	—
CLV16X36	16"	36"	FCLV16X36	21 Sq. In.	—
CLV18X24	18"	24"	FCLV18X24	20 Sq. In.	—
CLV18X30	18"	30"	FCLV18X30	36 Sq. In.	CLV18X30X4F
CLV18X54	18"	54"	FCLV18X54	50 Sq. In.	—
CLV22X31	22"	31-1/2"	FCLV22X31	41 Sq. In.	CLV22X31X4F
CLV24X48	24"	48"	FCLV24X48	73 Sq. In.	—
CLV28X43	28"	43"	FCLV28X43	76 Sq. In.	—
CLV36X48	36"	48"	FCLV36X48	102 Sq. In.	—

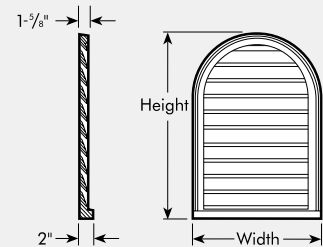

Flat Trim Part Number	Inside Width	Inside Height	Trim Width	Projection
CLV18X30X4F	18-1/4"	30-1/4"	3-1/2"	1"
CLV22X31X4F	22-1/4"	31-1/4"	3-1/2"	1"

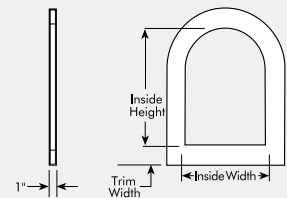



## Eyebrow Louver

Brickmould Style

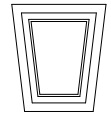
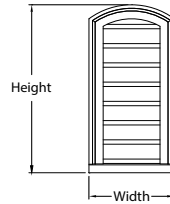
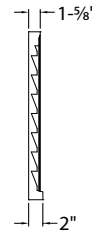

Keystone  
Page 55  
KWM180M

Decorative Part Number	Width	Overall Height	Shoulder Height	Radius	Functional Part Number	Vent Area
EBLV12X24	12"	24"	22"	10"	FEBLV12X24	13 Sq. In.
EBLV18X30	18"	30"	27-1/4"	16"	FEBLV18X30	30 Sq. In.
EBLV22X32	22"	32"	28-1/2"	20"	FEBLV22X32	38 Sq. In.

## Peaked Louver

Brickmould Style

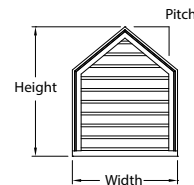
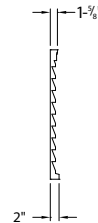

Decorative Part Number	Width	Height	Pitch	Functional Part Number	Vent Area
PLV18X24-8	18"	24"	8 / 12	FPLV18X24-8	20 Sq. In.
PLV18X36-10	18"	36"	10 / 12	FPLV18X36-10	35 Sq. In.
PLV24X30-10	24"	30"	10 / 12	FPLV24X30-10	37 Sq. In.
PLV24X36-10	24"	36"	10 / 12	FPLV24X36-10	48 Sq. In.
PLV24X36-12	24"	36"	12 / 12	FPLV24X36-12	47 Sq. In.

# Vertical Louver

Brickmould Style

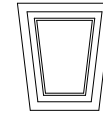
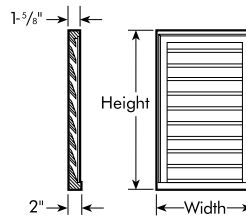

Keystone  
Page 55  
KWM180M

Decorative Part Number	Width	Height	Functional Part Number	Vent Area
LV8X15	8"	15"	FLV8X15	3 Sq. In.
LV8X24	8"	24"	FLV8X24	7 Sq. In.
LV8X30	8"	30"	FLV8X30	9 Sq. In.
LV12X18	12"	18"	FLV12X18	10 Sq. In.
LV12X24	12"	24"	FLV12X24	16 Sq. In.
LV12X30	12"	30"	FLV12X30	18 Sq. In.
LV12X36	12"	36"	FLV12X36	22 Sq. In.
LV12X40	12"	40"	FLV12X40	24 Sq. In.
LV14X27	14"	27"	FLV14X27	20 Sq. In.
LV14X30	14"	30"	FLV14X30	22 Sq. In.
LV14X32	14"	32"	FLV14X32	27 Sq. In.
LV16X24	16"	24"	FLV16X24	21 Sq. In.
LV16X36	16"	36"	FLV16X36	32 Sq. In.
LV18X24	18"	24"	FLV18X24	24 Sq. In.
LV18X30	18"	30"	FLV18X30	31 Sq. In.
LV18X36	18"	36"	FLV18X36	38 Sq. In.
LV18X42	18"	42"	FLV18X42	45 Sq. In.
LV20X28	20"	28"	FLV20X28	31 Sq. In.
LV24X24	24"	24"	FLV24X24	35 Sq. In.
LV24X30	24"	30"	FLV24X30	45 Sq. In.
LV24X36	24"	36"	FLV24X36	54 Sq. In.
LV24X48	24"	48"	FLV24X48	74 Sq. In.
LV30X42	30"	42"	FLV30X42	84 Sq. In.





## Vertical Louver

Brickmould Style with No Sill

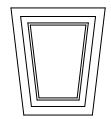
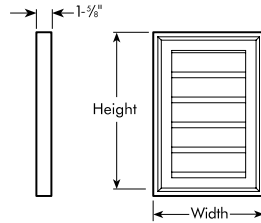

Keystone  
Page 55  
KWM180M

Decorative Part Number	Width	Height	Functional Part Number	Vent Area
LVNS18X24	18"	24"	FLVNS18X24	21 Sq. In.

## Vertical Louver

with 4F Flat Trim & 6" Crosshead

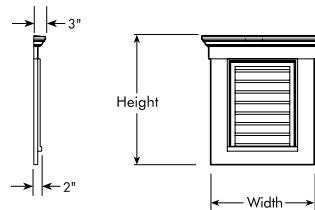

Decorative Part Number	Width	Overall Width	Height	Functional Part Number	Vent Area
LV18X24-4F6WCH	26-1/2"	31"	33-1/2"	FLV18X24-4F6WCH	24 Sq. In.



# Vertical Louver

with Flat Trim Attached

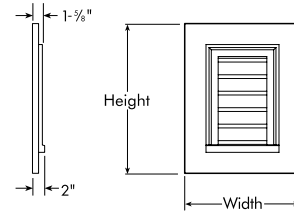

Decorative Part Number	Overall Width	Overall Height	Trim Width	Trim Projection
LV18X30-4F	25"	37"	3-1/2"	1"

# Horizontal Louver

Brickmould Style

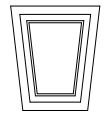
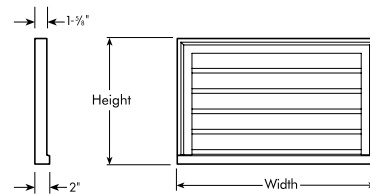

Keystone  
Page 55  
KWM180M

Decorative Part Number	Width	Height	Functional Part Number	Vent Area
LV27X17	27"	17"	FLV27X17	23 Sq. In.
LV32X16	32"	16"	FLV32X16	28 Sq. In.



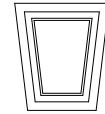

Keystone  
Page 55  
KWM180M

## Half-Round Louver

Brickmould Style

Decorative Part Number	Width	Height	Functional Part Number	Vent Area
HRLV24X12	24"	12"	FHRLV24X12	9 Sq. In.
HRLV28X14	28"	14"	FHRLV28X14	13 Sq. In.
HRLV32X16	32"	16"	FHRLV32X16	21 Sq. In.
HRLV36X18	36"	18"	FHRLV36X18	28 Sq. In.
HRLV40X20	40"	20"	FHRLV40X20	36 Sq. In.
HRLV42X21	42"	21"	FHRLV42X21	40 Sq. In.
HRLV48X24	48"	24"	FHRLV48X24	55 Sq. In.
HRLV60X30	60"	30"	FHRLV60X30	85 Sq. In.
HRLV72X36	72"	36"	FHRLV72X36	122 Sq. In.

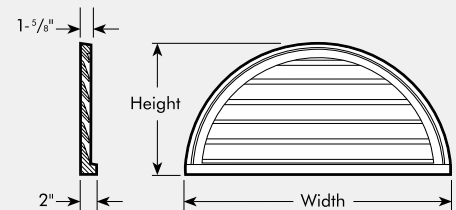

Note: Half-Round Arch Trim available on page 51.  
Parts may be required to ship LTL (less than truckload) based on size and overall dimensions.

# Half-Round Louver

with Flat Trim Attached

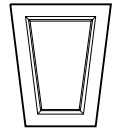
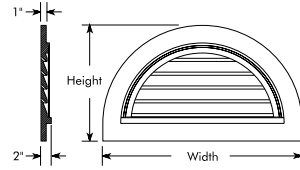

Keystone  
Page 55  
K4TF, KP4TF, K6TF, KP6TF

Decorative Part Number	Overall Width	Overall Height	Trim Width	Trim Projection	Functional Part Number	Vent Area
HRLV36X18-4F	43"	25"	3-1/2"	1"	FHRLV36X18-4F	29 Sq. In.
HRLV36X18-6F	47"	29"	5-1/2"	1"	FHRLV36X18-6F	29 Sq. In.

# Half-Round Louver

with Decorative Trim & Keystone

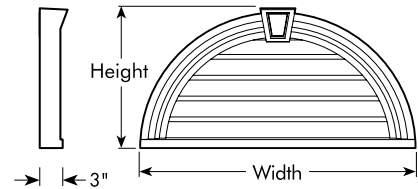

Decorative Part Number	Overall Width	Overall Height	Projection	Functional Part Number	Vent Area
HRLV36X18MTK	36"	18-1/2"	3"	FHRLV36X18MTK	24 Sq. In.

# Half-Round Louver

with Decorative Trim & Keystone

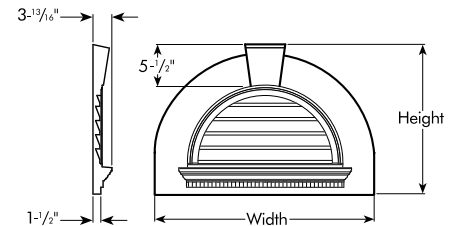

Decorative Part Number	Overall Width	Overall Height	Overall Projection	Trim Projection	Functional Part Number	Vent Area
HRLV29-6FKWD	41-5/8"	29"	3-3/4"	1-1/2"	FHRLV29-6FKWD	29 Sq. In.

# Round Louver

Brickmould Style



Round Louver

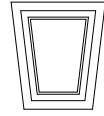

Keystone  
Page 55  
KWM180M\*



4F Flat Trim

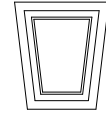

Keystone  
Page 55  
K4TF  
KP4TF

Decorative Part Number	Diameter	Functional Part Number	Vent Area	Louver Trim
RLV12**	12"	FRLV12**	7 Sq. In.	—
RLV16	16"	FRLV16	9 Sq. In.	—
RLV18	18"	FRLV18	12 Sq. In.	RLV18X4F
RLV22	22"	FRLV22	22 Sq. In.	—
RLV24	24"	FRLV24	27 Sq. In.	RLV24X4F
RLV28	28"	FRLV28	38 Sq. In.	RLV28X4F
RLV30	30"	FRLV30	46 Sq. In.	—
RLV36	36"	FRLV36	70 Sq. In.	CIR36X4F
RLV42	42"	FRLV42	99 Sq. In.	—
RLV48	48"	FRLV48	107 Sq. In.	—

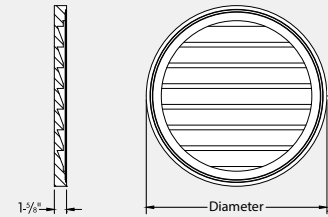

Trim Part Number	Trim Width	Projection	Inside Diameter
RLV18X4F	3-1/2"	1"	18-1/4"
RLV24X4F	3-1/2"	1"	24-1/4"
RLV28X4F	3-1/2"	1"	28-1/4"

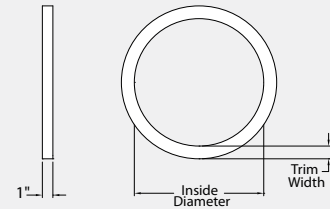

# Round Louver

with Flat Trim

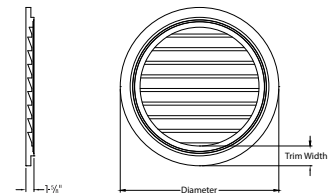

Decorative Part Number	Diameter	Trim Width	Trim Thickness	Functional Part Number	Vent Area
RLV32-2F	32"	2"	1-5/8"	FRLV32-2F	38 Sq. In.

\*Product must be field trimmed to match RLV12 and FRLV12.

\*\*1-5/16" projection on RLV12 and FRLV12.



## Round Louver

with Flat Trim & Flat Keystones

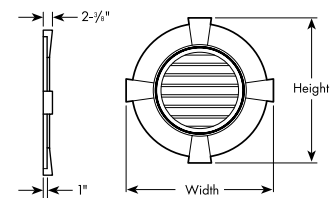

Decorative Part Number	Diameter	Overall Width / Height	Trim Width	Trim Thickness	Functional Part Number	Vent Area
RLV24-4FTK	31"	32-7/8"	3-1/2"	1"	FRLV24-4FTK	26 Sq. In.
RLV24-6TK	35"	38"	5-1/2"	1"	FRLV24-6TK	26 Sq. In.
RLV30-6TK	41"	44"	5-1/2"	1"	FRLV30-6TK	47 Sq. In.

## Round Louver

with Decorative Trim & Keystones

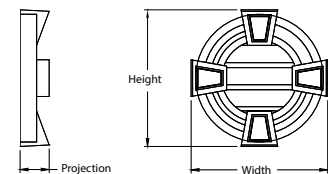

Decorative Part Number	Diameter	Overall Width / Height	Projection	Functional Part Number	Vent Area
RLV16MTK	16"	17-1/8"	3-5/8"	FRLV16MTK	4 Sq. In.
RLV18MTK	18"	19-1/8"	3-5/8"	FRLV18MTK	4 Sq. In.
RLV24MTK	23-7/8"	25"	3-5/8"	FRLV24MTK	19 Sq. In.
RLV30MTK	30"	31-1/8"	3-5/8"	FRLV30MTK	35 Sq. In.
RLV32MTK	31-5/8"	33-1/4"	4-1/8"	FRLV32MTK	26 Sq. In.
RLV40MTK	40"	41-1/4"	3-5/8"	FRLV40MTK	76 Sq. In.



## Round Louver

with Flat Trim & Keystone

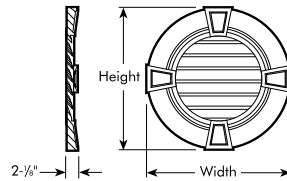

Decorative Part Number	Diameter	Width	Trim Width	Trim Thickness	Functional Part Number	Vent Area
RLV24TK	22- <sup>7</sup> / <sub>8</sub> "	24"	3- <sup>1</sup> / <sub>2</sub> "	1"	FRLV24TK	10 Sq. In.
RLV30TK	28- <sup>7</sup> / <sub>8</sub> "	30"	3- <sup>1</sup> / <sub>2</sub> "	1"	FRLV30TK	22 Sq. In.
RLV32TK	30- <sup>1</sup> / <sub>4</sub> "	31- <sup>1</sup> / <sub>2</sub> "	3- <sup>1</sup> / <sub>2</sub> "	1"	FRLV32TK	25 Sq. In.
RLV36TK	35"	36"	3- <sup>1</sup> / <sub>2</sub> "	1"	FRLV36TK	38 Sq. In.

## Oval Louver

Brickmould Style

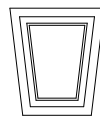

Keystone  
Page 55  
KWM180M

Decorative Part Number	Width	Height	Functional Part Number	Vent Area
OVLV18X24V	18"	24"	FOVLV18X24V	18 Sq. In.
OVLV25X37V	24- <sup>1</sup> / <sub>2</sub> "	37"	FOVLV25X37V	24 Sq. In.

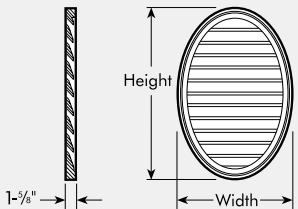

# Oval Louver – Vertical

with Decorative Trim & Keystones

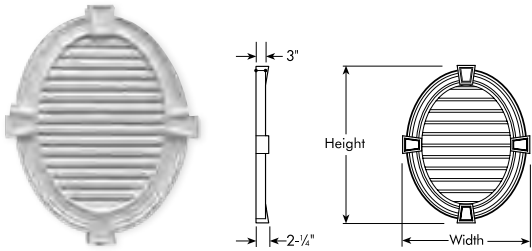

Decorative Part Number	Overall Width	Overall Height	Projection	Functional Part Number	Vent Area
OVL28X35K215V	30"	37-1/2"	3"	FOVL28X35K215V	39 Sq. In.

# Oval Louver – Vertical

with Flat Trim & Keystones

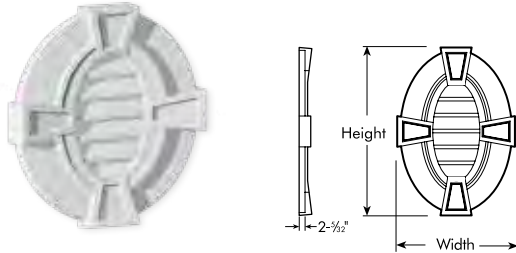

Decorative Part Number	Overall Width	Overall Height	Projection	Functional Part Number	Vent Area
OVLV20X29VTK	20"	29"	2-1/8"	FOVLV20X29VTK	9 Sq. In.

# Oval Louver – Horizontal

with Decorative Trim & Keystones

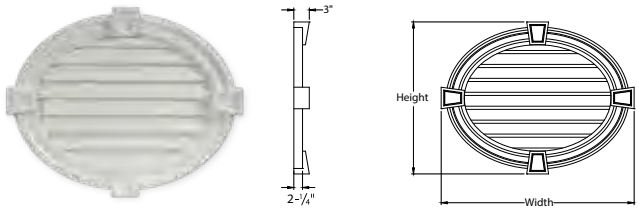

Decorative Part Number	Overall Width	Overall Height	Projection	Functional Part Number	Vent Area
OVL35X28K215	37-1/2"	30"	3"	FOVL35X28K215	41 Sq. In.

# Oval Louver – Horizontal

with Flat Trim & Keystones

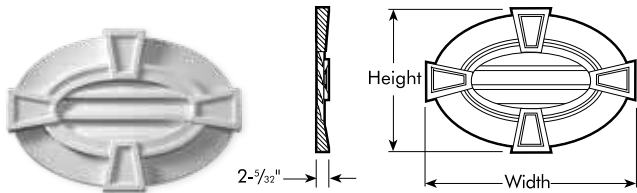

Decorative Part Number	Overall Width	Overall Height	Projection	Vent Area
OVLV29X20TK	29"	20-5/8"	2-1/8"	7 Sq. In.

# Triangle Louver

Brickmould Style

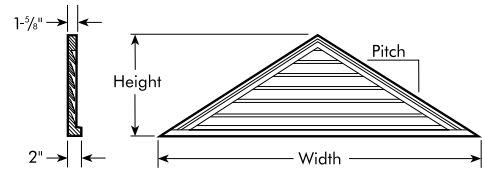

Decorative Part Number	Width	Height	Pitch	Functional Part Number	Vent Area
TRLV36X18	36"	18"	12 / 12	FTRLV36X18	10 Sq. In.
TRLV42X21	42"	21"	12 / 12	FTRLV42X21	18 Sq. In.
TRLV48X12	48"	12"	6 / 12	FTRLV48X12	12 Sq. In.
TRLV48X18	48"	18"	9 / 12	FTRLV48X18	19 Sq. In.
TRLV48X22	48"	22"	11 / 12	FTRLV48X22	27 Sq. In.
TRLV48X24	48"	24"	12 / 12	FTRLV48X24	31 Sq. In.
TRLV60X18	60"	17-1/2"	7 / 12	FTRLV60X18	27 Sq. In.
TRLV60X23	60"	22-1/2"	9 / 12	FTRLV60X23	30 Sq. In.
TRLV60X25	60"	25"	10 / 12	FTRLV60X25	33 Sq. In.
TRLV60X30	60"	30"	12 / 12	FTRLV60X30	51 Sq. In.
TRLV64X27	64"	26-1/2"	10 / 12	FTRLV64X27	34 Sq. In.
TRLV64X32	64"	32"	12 / 12	FTRLV64X32	60 Sq. In.
TRLV66X22	66"	22"	8 / 12	FTRLV66X22	35 Sq. In.
TRLV72X36	72"	36"	12 / 12	FTRLV72X36	79 Sq. In.
TRLV76X19	76"	19"	6 / 12	FTRLV76X19	30 Sq. In.
TRLV84X18	84"	17-1/2"	5 / 12	FTRLV84X18	34 Sq. In.
TRLV84X21	84"	21"	6 / 12	FTRLV84X21	44 Sq. In.
TRLV88X22	88"	22"	6 / 12	FTRLV88X22	38 Sq. In.



# Two-Piece Triangle Louver

Brickmould Style

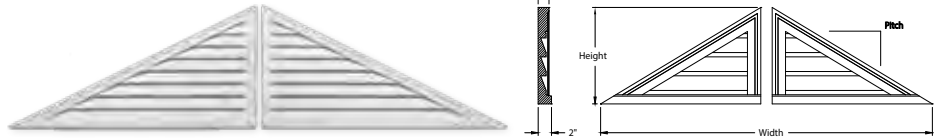

Decorative Part Number	Width	Height	Pitch	Functional Part Number	Vent Area
TRLVLR60X25	60"	25"	10 / 12	FTRLVLR60X25	35 Sq. In.
TRLVLR60X30	60"	30"	12 / 12	FTRLVLR60X30	46 Sq. In.
TRLVLR108X27	108"	27"	6 / 12	FTRLVLR108X27	78 Sq. In.
TRLVLR115X35	115"	34-1/2"	7-1/4 / 12	FTRLVLR115X35	133 Sq. In.
TRLVLR120X30	120"	30"	6 / 12	FTRLVLR120X30	104 Sq. In.

# Diamond Louver

Brickmould Style

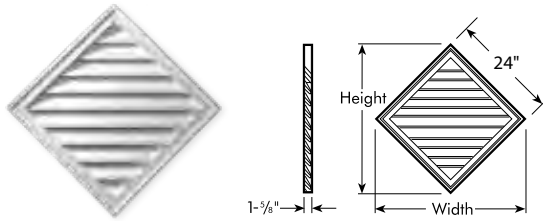

Decorative Part Number	Width	Height	Functional Part Number	Vent Area
DLV24X24	34"	34"	FDLV24X24	32 Sq. In.

# Octagon Louver

Brickmould Style

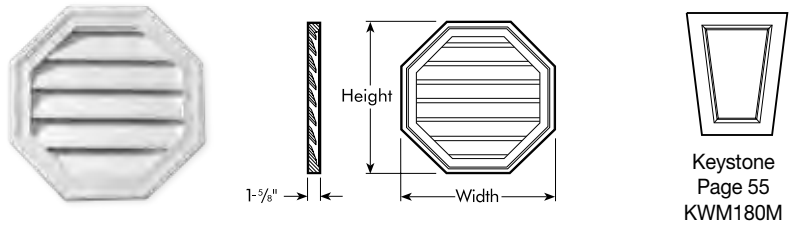

Decorative Part Number	Width	Height	Functional Part Number	Vent Area
OLV18	18"	18"	FOLV18	14 Sq. In.
OLV22	22"	22"	FOLV22	23 Sq. In.
OLV24	24"	24"	FOLV24	29 Sq. In.
OLV28	28"	28"	FOLV28	41 Sq. In.

# Column Wraps



## COVERAGE WITH CHARACTER.

Once you've met the structural requirements of your project, Fypon® Column Wraps can be used to add an elegant finishing touch. Designed for easy installation around an existing structural support, column wraps are perfect for adding character to a new job or covering an outdated design.



**NEW** Structural Post .....205

**NEW** EverCedar Flat-Pack  
Square Column Wraps .....207

**NEW** EverCedar Flat-Pack  
Tapered Column Wraps .....208

ProSelect PVC Smooth  
Square Column Wraps .....210

**NEW** ProSelect PVC Flat-Pack  
Square Column Wraps .....211

PremiumSelect  
Square Column Wraps .....213

**NEW** PremiumSelect Flat-Pack  
Square Column Wraps .....214

Square Cap & Base  
Accessories .....215

PremiumSelect Tapered  
Column Wraps .....216

**NEW** PremiumSelect Flat-Pack  
Tapered Column Wraps .....218

Tapered Cap & Base  
Accessories.....219

**Product Shown:**  
EverCedar Wood-Grained Flat-Pack Square Column Wraps  
Wood-Grained Flat Trim



# Column Wraps

---

## HOW TO ORDER

### Column Wraps

Fypon® Column Wraps are non-structural and designed to wrap around an existing treated wood post or other structural support. Square and tapered styles are available in a variety of heights and are trimmable from the bottom of the shaft up to 3". Flat-panel column wraps can be trimmed to any height.

PremiumSelect Column Wraps come in a complete kit that includes shaft, cap, base, installation cleat, hardware, tube of adhesive and installation materials. Installation kits for ProSelect Column Wraps are sold separately.

New flat-pack column wraps ship unassembled for better handling and utilization of less storage space. Choose from square and tapered styles in smooth PVC or wood-grained polyurethane.

### Column Wrap Accessories

Square column wraps come semi-assembled and include a Traditional cap and base, and tapered column wraps come semi-assembled and include a Craftsman cap and base. Six additional cap and base styles are available and can be ordered separately. Caps and bases ship in four separate pieces with pre-mitered corners.

### Special Order Products

PremiumSelect products shown in the catalog are available in additional sizes. Product may be modified to minimum 6" width to a 24" maximum width. The height may also be modified with a minimum height of 48" to a maximum of 144" height (maximum 108" for tapered).



## FLEXIBLE POSITIONING COLUMN WRAPS

The design features installation cleats on the interior or exterior of the shaft providing ample room around the support post. This allows for positioning adjustments to align several columns in a row or to allow for positioning close to the porch edge. Also, because the column wrap does not come in contact with the structural post, the integrity of the wrap is not dependent on the support.

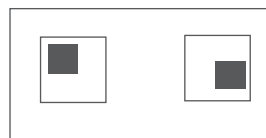

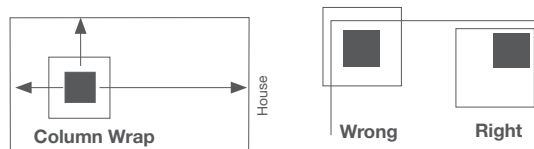

Flexible positioning around support post.

Before you order, you'll want to measure to make sure you have enough clear distance from the support post to the edge of the porch. The needed space is dependent on the style of column. You will need more space for tapered columns than square due to the larger base.



Allow adequate distance when choosing wrap width.

## Accessories

	Description	Height	Part Number
	Installation Kit includes adhesive and screw pack.	—	CWINSTALLKIT
	<div style="text-align: center; background-color: #444; color: white; padding: 5px; margin-bottom: 10px;"><b>NEW</b></div> Aluminum Structural Post with a load-bearing capacity of 5,000 lbs.* Kit includes aluminum post, 4x4 post mount and screws.	96" 108" 120"	STRPOSTKIT96 STRPOSTKIT108 STRPOSTKIT120

\*Average ultimate wind uplift resistance of 1200 lbs.

Note: Always consult the local building code authority to determine suitability of products to meet specific project requirements. Parts may be required to ship LTL (less than truckload) based on size and overall dimensions.



# EverCedar Wood-Grained Flat-Pack Square Column Wraps

Unassembled with Standard Cap & Base

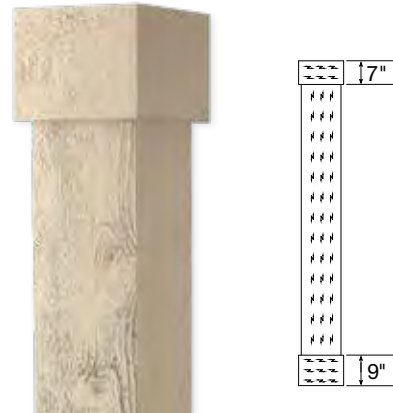

Shaft Width	Height	Flat Panel (FT)
<b>6"</b> (5-3/4" Actual)	8' (96")	CWEVFLT6X96SFT
	9' (108")	CWEVFLT6X108SFT
	10' (120")	CWEVFLT6X120SFT
4-1/4" Actual Inside Width		
<b>8"</b> (7-3/4" Actual)	8' (96")	CWEVFLT8X96SFT
	9' (108")	CWEVFLT8X108SFT
	10' (120")	CWEVFLT8X120SFT
6-1/4" Actual Inside Width		
<b>10"</b> (9-3/4" Actual)	8' (96")	CWEVFLT10X96SFT
	9' (108")	CWEVFLT10X108SFT
	10' (120")	CWEVFLT12X120SFT
8-1/4" Actual Inside Width		
<b>12"</b> (11-3/4" Actual)	8' (96")	CWEVFLT12X96SFT
	9' (108")	CWEVFLT12X108SFT
	10' (120")	CWEVFLT12X108SFT
10-1/4" Actual Inside Width		

Column Wraps

## Square Cap & Base Accessories

	6" x 6"	8" x 8"	10" x 10"	12" x 12"	
		CWCB6EV	CWCB8EV	CWCB10EV	CWCB12EV
		Ships standard with all EverCedar Square Column Wrap Kits.			

# EverCedar Wood-Grained Flat-Pack Tapered Column Wraps

Unassembled with Standard Cap & Base

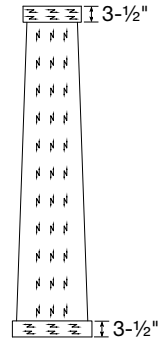

Shaft Width	Height	Flat
<b>8"</b> Top (7-3/4" Actual)  <b>12"</b> Bottom (11-3/4" Actual)	4' (48")	CWEVFLT8X12X48TFT
	4-1/2' (54")	CWEVFLT8X12X54TFT
	5' (60")	CWEVFLT8X12X60TFT
	5-1/2' (66")	CWEVFLT8X12X66TFT
	6' (72")	CWEVFLT8X12X72TFT
	8' (96")	CWEVFLT8X12X96TFT
<b>11"</b> Top (10-3/4" Actual)  <b>16"</b> Bottom (15-3/4" Actual)	4' (48")	CWEVFLT11X16X48TFT
	4-1/2' (54")	CWEVFLT11X16X54TFT
	5' (60")	CWEVFLT11X16X60TFT
	5-1/2' (66")	CWEVFLT11X16X66TFT
	6' (72")	CWEVFLT11X16X72TFT
	8' (96")	CWEVFLT11X16X96TFT

Column Wraps

## Tapered Cap & Base Accessories

	8" x 12"	11" x 16"
	CWCB8X12EV48-60*	CWCB11X16EV48-60*
	CWCB8X12EV66-96**	CWCB11X16EV66-96**
Ships standard with all EverCedar Tapered Column Wrap Kits.		

\*Cap and base size for tapered column wraps 48-60" in height.

\*\*Cap and base size for tapered column wraps 66-96" in height.

Parts may be required to ship LTL (less than truckload) based on size and overall dimensions.





# ProSelect Square Column Wraps

Semi-Assembled PVC Flat Panel with Plain Cap & Base

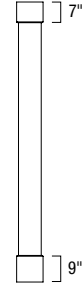

Shaft Width	Height	Flat Panel (FT)
<b>6"</b> (5- <sup>3</sup> / <sub>4</sub> " Actual) 4" Actual Inside Width	6' (72")	CWPR6X72SFT
	8' (96")	CWPR6X96SFT
	9' (108")	CWPR6X108SFT
	10' (120")	CWPR6X120SFT
	12' (144")	CWPR6X144SFT
<b>8"</b> (7- <sup>3</sup> / <sub>4</sub> " Actual) 4- <sup>7</sup> / <sub>8</sub> " Actual Inside Width	6' (72")	CWPR8X72SFT
	8' (96")	CWPR8X96SFT
	9' (108")	CWPR8X108SFT
	10' (120")	CWPR8X120SFT
	12' (144")	CWPR8X144SFT
<b>10"</b> (9- <sup>3</sup> / <sub>4</sub> " Actual) 6- <sup>7</sup> / <sub>8</sub> " Actual Inside Width	6' (72")	CWPR10X72SFT
	8' (96")	CWPR10X96SFT
	9' (108")	CWPR10X108SFT
	10' (120")	CWPR10X120SFT
	12' (144")	CWPR10X144SFT
<b>12"</b> (11- <sup>3</sup> / <sub>4</sub> " Actual) 8- <sup>7</sup> / <sub>8</sub> " Actual Inside Width	6' (72")	CWPR12X72SFT
	8' (96")	CWPR12X96SFT
	9' (108")	CWPR12X108SFT
	10' (120")	CWPR12X120SFT
	12' (144")	CWPR12X144SFT

Note: ProSelect is not available for special orders.  
 Parts may be required to ship LTL (less than truckload) based on size and overall dimensions.

# ProSelect Flat-Pack Square Column Wraps

Unassembled PVC Shaft (cap and base sold separately)

## Features

- ProSelect square column shaft features a flat-panel style.
- Accessories are sold separately, allowing you to create a custom look. See page 215 for additional options.
- Interior cleat included for easy installation.
- Installation materials sold separately. See page 205.
- Product ships flat for easy handling and storage.
- Optional Structural Post Kit has a load-bearing capacity of up to 5000 lbs. and an average wind uplift resistance of 1200 lbs.



Shaft Width	Height	Flat Panel (FT)
<b>6"</b> (5-3/4" Actual)	8' (96")	CWPRFLT6X6X96SFT
	9' (108")	CWPRFLT6X6X108SFT
4" Actual Inside Width		





# PremiumSelect Square Column Wraps

Semi-Assembled with Traditional Cap & Base

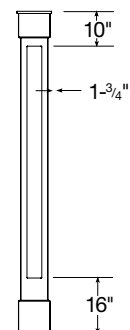
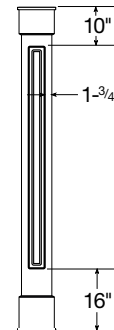
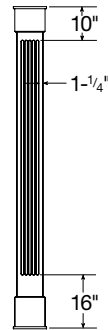

Flutes are 5/8" wide and 1/4" deep. Number and spacing of flutes varies by width of shaft.

Route is 1-11/32" wide by 3/8" deep.

Recess is 1/2" deep and corners are 1/4" rounded.



Shaft Width	Height	Flat Panel (FT)	Fluted (FL)	Raised Panel (RS)	Recessed Panel (RC)
<b>6"</b> (5-3/4" Actual)	6' (72")	CWPM6X72SFT	—	—	—
	8' (96")	CWPM6X96SFT	—	—	—
	9' (108")	CWPM6X108SFT	—	—	—
	10' (120")	CWPM6X120SFT	—	—	—
	12' (144")	CWPM6X144SFT	—	—	—
4-3/4" Actual Inside Width					
<b>8"</b> (7-3/4" Actual)	6' (72")	CWPM8X72SFT	CWPM8X72SFL	CWPM8X72SRS	CWPM8X72SRC
	8' (96")	CWPM8X96SFT	CWPM8X96SFL	CWPM8X96SRS	CWPM8X96SRC
	9' (108")	CWPM8X108SFT	CWPM8X108SFL	CWPM8X108SRS	CWPM8X108SRC
	10' (120")	CWPM8X120SFT	CWPM8X120SFL	CWPM8X120SRS	CWPM8X120SRC
	12' (144")	CWPM8X144SFT	CWPM8X144SFL	CWPM8X144SRS	CWPM8X144SRC
6-3/4" Actual Inside Width			5-3/4" Actual Inside Width		
<b>10"</b> (9-3/4" Actual)	6' (72")	CWPM10X72SFT	CWPM10X72SFL	CWPM10X72SRS	CWPM10X72SRC
	8' (96")	CWPM10X96SFT	CWPM10X96SFL	CWPM10X96SRS	CWPM10X96SRC
	9' (108")	CWPM10X108SFT	CWPM10X108SFL	CWPM10X108SRS	CWPM10X108SRC
	10' (120")	CWPM10X120SFT	CWPM10X120SFL	CWPM10X120SRS	CWPM10X120SRC
	12' (144")	CWPM10X144SFT	CWPM10X144SFL	CWPM10X144SRS	CWPM10X144SRC
8-3/4" Actual Inside Width			7-3/4" Actual Inside Width		
<b>12"</b> (11-3/4" Actual)	6' (72")	CWPM12X72SFT	CWPM12X72SFL	CWPM12X72SRS	CWPM12X72SRC
	8' (96")	CWPM12X96SFT	CWPM12X96SFL	CWPM12X96SRS	CWPM12X96SRC
	9' (108")	CWPM12X108SFT	CWPM12X108SFL	CWPM12X108SRS	CWPM12X108SRC
	10' (120")	CWPM12X120SFT	CWPM12X120SFL	CWPM12X120SRS	CWPM12X120SRC
	12' (144")	CWPM12X144SFT	CWPM12X144SFL	CWPM12X144SRS	CWPM12X144SRC
10-3/4" Actual Inside Width			9-3/4" Actual Inside Width		

Note: Installation cleats ship with column wrap and are applied on the exterior shaft. Parts may be required to ship LTL (less than truckload) based on size and overall dimensions.

# PremiumSelect Flat-Pack Square Column Wraps

Unassembled PVC Shaft (cap and base sold separately)









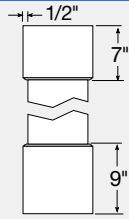

## Features

- PremiumSelect square column shaft features a flat-panel style.
- Accessories are sold separately, allowing you to create a custom look. See page 215 for additional options.
- Exterior cleat included for easy installation.
- Installation materials sold separately.
- Product ships flat for easy handling and storage.
- Optional Structural Post Kit has a load-bearing capacity of up to 5000 lbs. and an average wind uplift resistance of 1200 lbs.

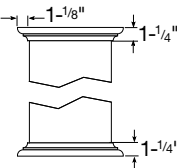
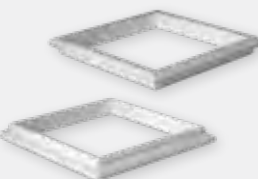
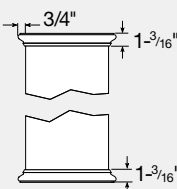
Shaft Width	Height	Flat Panel (FT)
<b>6"</b> (5-3/4" Actual)	9' (108")	CWPMFLT6X6X108SFT
	10' (120")	CWPMFLT6X6X120SFT
	4-3/4" Actual Inside Width	
<b>8"</b> (7-3/4" Actual)	8' (96")	CWPMFLT8X8X96SFT
	9' (108")	CWPMFLT8X8X108SFT
	10' (120")	CWPMFLT8X8X120SFT
6-3/4" Actual Inside Width		
<b>10"</b> (9-3/4" Actual)	8' (96")	CWPMFLT10X10X96SFT
	9' (108")	CWPMFLT10X10X108SFT
	10' (120")	CWPMFLT10X10X120SFT
8-3/4" Actual Inside Width		

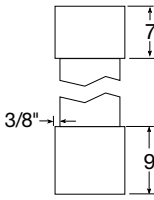
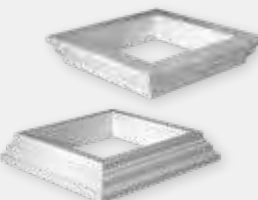
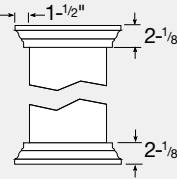

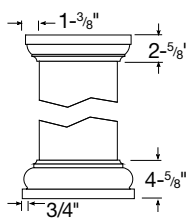
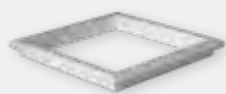
# Square Cap & Base Accessories

Style	6" x 6"	8" x 8"	10" x 10"	12" x 12"
<b>Traditional</b>  	CWCB6TR	CWCB8TR	CWCB10TR	CWCB12TR
Ships standard with the semi-assembled PremiumSelect Square Column Wrap Kits.				
<b>Craftsman</b>  	CWCB6CF	CWCB8CF	CWCB10CF	CWCB12CF
<b>Greek</b>  	CWCB6GK	CWCB8GK	CWCB10GK	CWCB12GK
<b>Plain</b>  	CWCB6PL	CWCB8PL	CWCB10PL	CWCB12PL
Ships standard with the semi-assembled ProSelect Square Column Wrap Kits.				
<b>Roman</b>  	CWCB6RO	CWCB8RO	CWCB10RO	CWCB12RO
<b>Tuscan</b>  	CWCB6TS	CWCB8TS	CWCB10TS	CWCB12TS
Tuscan cap and base are high-density polyurethane.				
<b>Neck Mould</b>  	CW6NM	CW8NM	CW10NM	CW12NM

# PremiumSelect Tapered Column Wraps

Semi-Assembled with Craftsman Cap & Base

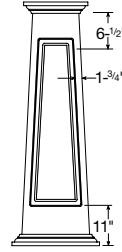
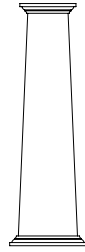

Route is 1-3/8" wide by 3/8" deep.

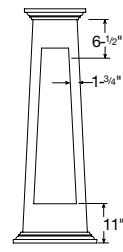

Recess is 1/2" deep and corners are 1/4" rounded.



Shaft Width	Height	Flat	Raised Panel	Recessed Panel
<b>8" Top</b> (7-3/4" Actual)	4' (48")	CWPM8X12X48TFT	CWPM8X12X48TRS	CWPM8X12X48TRC
	4-1/2' (54")	CWPM8X12X54TFT	CWPM8X12X54TRS	CWPM8X12X54TRC
	5' (60")	CWPM8X12X60TFT	CWPM8X12X60TRS	CWPM8X12X60TRC
<b>12" Bottom</b> (11-3/4" Actual)	5-1/2' (66")	CWPM8X12X66TFT	CWPM8X12X66TRS	CWPM8X12X66TRC
	6' (72")	CWPM8X12X72TFT	CWPM8X12X72TRS	CWPM8X12X72TRC
	8' (96")	CWPM8X12X96TFT	CWPM8X12X96TRS	CWPM8X12X96TRC
<b>11" Top</b> (10-3/4" Actual)	4' (48")	CWPM11X16X48TFT	CWPM11X16X48TRS	CWPM11X16X48TRC
	4-1/2' (54")	CWPM11X16X54TFT	CWPM11X16X54TRS	CWPM11X16X54TRC
	5' (60")	CWPM11X16X60TFT	CWPM11X16X60TRS	CWPM11X16X60TRC
<b>16" Bottom</b> (15-3/4" Actual)	5-1/2' (66")	CWPM11X16X66TFT	CWPM11X16X66TRS	CWPM11X16X66TRC
	6' (72")	CWPM11X16X72TFT	CWPM11X16X72TRS	CWPM11X16X72TRC
	8' (96")	CWPM11X16X96TFT	CWPM11X16X96TRS	CWPM11X16X96TRC
<b>13" Top</b> (12-3/4" Actual)	4' (48")	CWPM13X20X48TFT	CWPM13X20X48TRS	CWPM13X20X48TRC
	4-1/2' (54")	CWPM13X20X54TFT	CWPM13X20X54TRS	CWPM13X20X54TRC
	5' (60")	CWPM13X20X60TFT	CWPM13X20X60TRS	CWPM13X20X60TRC
<b>20" Bottom</b> (19-3/4" Actual)	5-1/2' (66")	CWPM13X20X66TFT	CWPM13X20X66TRS	CWPM13X20X66TRC
	6' (72")	CWPM13X20X72TFT	CWPM13X20X72TRS	CWPM13X20X72TRC
	8' (96")	CWPM13X20X96TFT	CWPM13X20X96TRS	CWPM13X20X96TRC
<b>16" Top</b> (15-3/4" Actual)	4' (48")	CWPM16X24X48TFT	CWPM16X24X48TRS	CWPM16X24X48TRC
	4-1/2' (54")	CWPM16X24X54TFT	CWPM16X24X54TRS	CWPM16X24X54TRC
	5' (60")	CWPM16X24X60TFT	CWPM16X24X60TRS	CWPM16X24X60TRC
<b>24" Bottom</b> (23-3/4" Actual)	5-1/2' (66")	CWPM16X24X66TFT	CWPM16X24X66TRS	CWPM16X24X66TRC
	6' (72")	CWPM16X24X72TFT	CWPM16X24X72TRS	CWPM16X24X72TRC
	8' (96")	CWPM16X24X96TFT	CWPM16X24X96TRS	CWPM16X24X96TRC

Note: Installation cleats ship with column wrap and are applied on the exterior shaft.  
Parts may be required to ship LTL (less than truckload) based on size and overall dimensions.





10260

# PremiumSelect Flat-Pack Tapered Column Wraps

Unassembled PVC Shaft (cap and base sold separately)



## Features





- PremiumSelect tapered style features a flat-panel shaft.
- Accessories are sold separately, allowing you to create a custom look. See page 219 for additional options.
- Exterior cleat included for easy installation.
- Product ships flat for easy handling or storage.
- Optional Structural Post Kit has a load-bearing capacity of up to 5000 lbs. and an average wind uplift resistance of 1200 lbs.

Shaft Width	Height	Flat
<b>8"</b> Top (7- <sup>3</sup> / <sub>4</sub> " Actual)	5' (60")	CWPMFLT8X12X60TFT
	5- <sup>1</sup> / <sub>2</sub> ' (66")	CWPMFLT8X12X66TFT
<b>12"</b> Bottom (11- <sup>3</sup> / <sub>4</sub> " Actual)	6' (72")	CWPMFLT8X12X72TFT
<b>11"</b> Top (10- <sup>3</sup> / <sub>4</sub> " Actual)	5' (60")	CWPMFLT11X16X60TFT
	5- <sup>1</sup> / <sub>2</sub> ' (66")	CWPMFLT11X16X66TFT
<b>16"</b> Bottom (15- <sup>3</sup> / <sub>4</sub> " Actual)	6' (72")	CWPMFLT11X16X72TFT



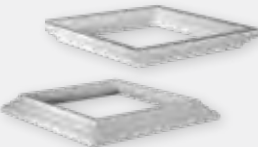
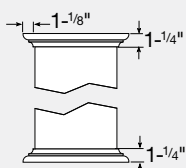
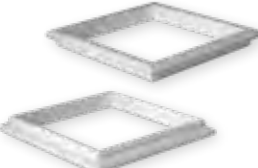
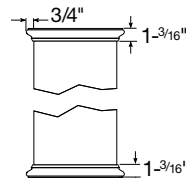

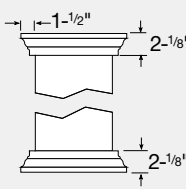
## Tapered Cap & Base Accessories

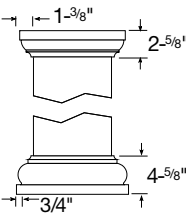
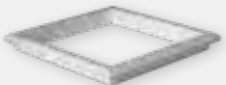
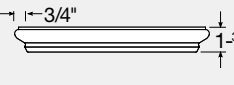
Style	8" x 12"	11" x 16"	13" x 20"	16" x 24"	
<b>Craftsman</b> 		CWCB8X12CF	CWCB11X16CF	CWCB13X20CF	CWCB16X24CF
Ships standard with semi-assembled PremiumSelect Tapered Column Wrap Kits.					
<b>Greek</b> 		CWCB8X12GK	CWCB11X16GK	CWCB13X20GK	CWCB16X24GK
<b>Roman</b> 		CWCB8X12RO	CWCB11X16RO	CWCB13X20RO	CWCB16X24RO
<b>Tuscan</b> 		CWCB8X12TS	CWCB11X16TS	CWCB13X20TS	CWCB16X24TS
Tuscan cap and base are high-density polyurethane.					
<b>Neck Mould</b> 		CW17NM		Trimnable to fit up to 16" wide top width.	

# Rail Systems



## BEAUTY MADE EASY.

Discover beautiful railing and balustrade systems, made more durable through our special manufacturing process. Low-maintenance and resistant to decay, our rail system products come with simple, step-by-step installation instructions.



Premium Straight Rail Kits .....224

Premium Stair Rail Kits.....225

Premium Gate Kits .....225

Post Kits .....226

Post Sleeves & Accessories .....226

Bracket & Adapter Kits .....228

Individual Components .....229

QuickPost® Synthetic Porch Post ...230

DuraPoly® Synthetic Porch Post .....231

**Product Shown:**  
Premium Straight Rail Kit  
Premium Stair Rail Kit  
Ultra Post Kit



# Rail Systems

---

## HOW TO USE THIS SECTION

For ease of use, the product groupings in this section of the catalog are organized by size, from smallest to largest, where applicable. Each product chart includes product images, dimensional data and part numbers to help specify, source and sell Fypon® Rail Systems.

---

## HOW TO ORDER

### Rail Systems

Rail Kits are available for both straight and stair applications. Each kit includes a top rail, a bottom rail, spindles, a crush block\*, brackets, bracket covers and the necessary screws for fast installation. Rail Kits can be attached to a wall, newel post or porch post.

Note: Stair Rail Kits cannot be attached to round columns or 45° post applications.

Plan your layout by determining the size and configuration of your porch, including any stairs. The most important step to building your order is creating an accurate layout. Check local building codes to determine minimum guardrail height, maximum rail span and structural post requirements for your area. Determine the number of rail and post kits you need to accommodate your layout.

Next, choose spindle style. Then find the part number of the rail kit that meets your style, length and height requirements.

Finally, determine size and style of any accessories needed to achieve the desired look.

### Rail System Accessories

A variety of accessories are available to create your own unique system, including post kits, post sleeves and porch posts. If you have an application where additional or unique connections are required, bracket and adapter kits are sold separately. Individual components are also sold separately.

---

\*Stair Rail Kits do not include crush block.

Note: Always consult the local building code authority to determine suitability of products to meet specific project requirements.

## BUILDING CODE COMPLIANCE

Fypon Rail System products are building code complaint over 30" above ground when rail lengths are 8' or less installed between our Ultra Post Kits, and 10' or less installed between structural posts or 4" x 4" treated wood posts with post sleeves. Applications 30" above ground and lower are decorative, and do not fall under any building code or testing standard. The 8', 10' and 12' rail kits include a top rail metal insert that must be used in any installation. 6' rail kits do not require an insert.

Fypon has received confirmation from ICC Evaluation Service, LLC (ICC-ES), that its Rail Systems comply with the provisions of the International Building Code and International Residential Code. The ICC-ES confirmation, published in evaluation report ESR-2601, will help code officials approve use of Rail Systems under the codes. The Fypon evaluation report is available online at [www.icc-es.org](http://www.icc-es.org).

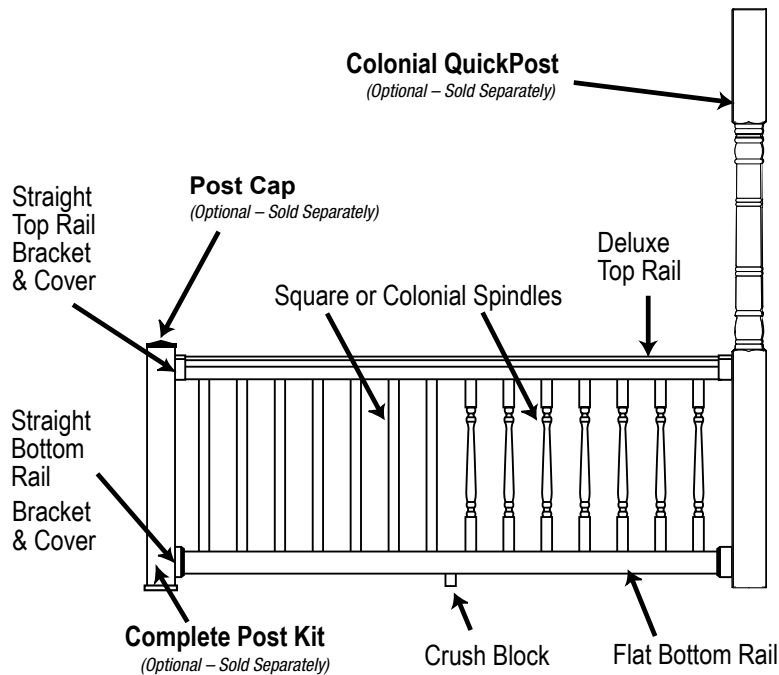

# Premium Railing

## Premium Rail Kits

### Options & Features

- Height Options: 36" or 42" rail height.
- Length Options: 6', 8', 10' or 12' nominal lengths.
- Spindle Options: Colonial or Square.
- Finish Color: White.
- Application: Straight or stair (30°- 40° slope).
- Additional Accessories: Multi-angle brackets and 45° adapters are available as special order.

## Kit Contents

### Straight & Stair Rail Kits

Each Straight or Stair Rail Kit includes the following:

- Top Rail
- Top Rail Structural Insert\* (Not Included in 6' Kits)
- Bottom Rail
- Colonial or Square Spindles
- Crush Block\*\*
- Brackets & Bracket Covers
- Screw Pack

## Straight Rail Kits



### Square

Description	6' Kits	8' Kits	10' Kits	12' Kits
<b>Square Spindles</b>	Actual length 72"	Actual length 96"	Actual length 120"	Actual length 144"
36" Rail Height	740636SQDF	740836SQDF	741036SQDF	741236SQDF
42" Rail Height	740642SQDF ♦	740842SQDF	741042SQDF	741242SQDF

### Colonial

Description	6' Kits	8' Kits	10' Kits	12' Kits
<b>Colonial Spindles</b>	Actual length 70-1/2"	Actual length 94-1/8"	Actual length 117-3/4"	Actual length 141"
36" Rail Height	740636CLDF	740836CLDF	741036CLDF	741236CLDF ♦

♦ Special order.

\*Structural insert is not included in the 6' Kit.

\*\*Crush block not included in Stair Rail Kits.

Note: Always consult the local building code authority to determine suitability of products to meet specific project requirements.

Note: 8', 10' and 12' Rail Kits include aluminum rail insert for added support. Aluminum inserts come in kits only. Posts are sold separately from kits.



# Stair Rail Kits

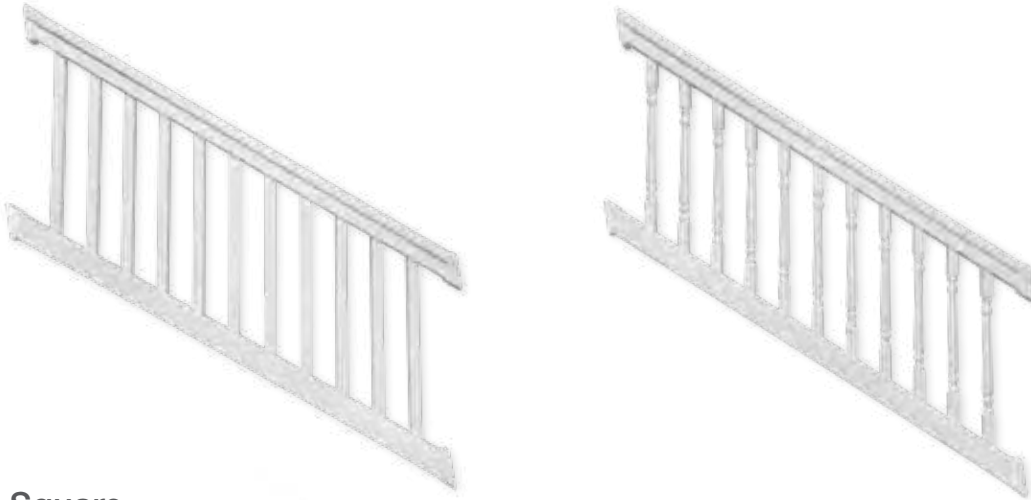

## Square

Description	6' Kits	8' Kits	10' Kits	12' Kits
<b>Square Spindles</b>	Actual length 78"	Actual length 102"	Actual length 126"	
36" Rail Height	740636SQDS	740836SQDS	741036SQDS	—
42" Rail Height	740642SQDS ♦	740842SQDS	741042SQDS ♦	—

## Colonial

Description	6' Kits	8' Kits	10' Kits	12' Kits
<b>Colonial Spindles</b>	Actual length 78"	Actual length 102"	Actual length 126"	
36" Rail Height	740636CLDS	740836CLDS	741036CLDS	—

# Gate Kits



Gate Kits come with a latch, hinges and mounting hardware, and are available in 36" and 42" heights. The Gate Kit components are pre-cut to fit a 37-1/2" wide opening but can be trimmed for smaller applications. Be sure to check local building codes for any dimension requirements when planning your system layout.

### 2020 Improvements!

New nylon spring-loaded gate hinges and locking entry latch provide a durable, quiet, lighter weight connection between the gate and posts with added security.

Description	Spindle Style	Gate Width	Kit Height	Part Number
35" x 36" Gate Kit	Square	35"	36"	4436SQDFGK ♦
35" x 36" Gate Kit	Colonial	35"	36"	4436CLDFGK
35" x 42" Gate Kit	Square	35"	42"	4442SQDFGK ♦

**IMPORTANT:** Gate Kit should NOT be attached to Complete Post Kit. It is recommended to attach the Gate Kit to a structural 4"x4" or 5"x5" treated post covered with a post sleeve. Note: This product can only be installed on structural surfaces less than 30" above ground.

# Post Kits

## Complete Post Kits for elevations 30" or less

The Complete Post Kit comes with a standard post mount and can be used to connect rail sections on substrates with elevations of 30" or less. Complete Post Kits include a cap, base, standard PVC post mount and the necessary hardware for installation on both pressure-treated wood decking and masonry surfaces.

Description	4" x 4"	5" x 5"	
	Inside width 3-5/8"	Inside width 4-5/8"	
	<b>Complete Post Kit</b>		
	38" Height	40050438PK	40050538PK ♦
	44" Height	40050444PK	40050544PK ♦
Hardware Kit	4005ACQHDR	4005ACQHDR	

## Ultra Post Kits for elevations higher than 30"

The ultra post is a structural, commercial-grade newel post that can be used on substrates with elevations higher than 30". Ultra Post Kits include a cap, base, structural post mount and the necessary hardware for installation on either wood / composite or concrete / masonry surfaces.

Description	4" x 4" Wood or Composite Substrate	4" x 4" Concrete or Masonry Substrate	
	Inside width 3-5/8"	Inside width 3-5/8"	
	<b>Ultra Post Kit</b>		
	38" Height	70050438WPK ♦	70050438CPK ♦
	44" Height	70050444WPK ♦	70050444CPK ♦









♦ Special order.

Note: Straight rail systems are code compliant 30" and greater above ground when used with Ultra Post Kit. Parts may be required to ship LTL (less than truckload) based on size and overall dimensions.

# System Accessories







## Post Sleeves

The post sleeve is a one-piece, hollow design that slides over an existing 4" x 4" or 5" x 5" support post.

	Description	4" x 4"	5" x 5"
	<b>Complete Post Kit</b>	Inside width 3-5/8"	Inside width 4-5/8"
	38" Height	40050438PS	40050538PS 
	44" Height	40050444PS 	40050544PS 
	48" Height	40050448PS 	—
	60" Height	40050460PS 	—
	96" Height	40050408PS 	40050508PS 
	108" Height	40050409PS 	40050509PS 

## Accessories

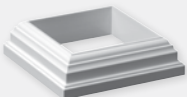
Post sleeves can be accented with a variety of caps and bases to customize your system.

	Description	Fits 4" x 4"	Fits 5" x 5"
	Taper Cap	40040404TC	40040505TC 
	New England Cap	40040404NC 	40040505NC 
	New England Base	40040404PB 	40040505PB 

# Bracket & Adapter Kits



Description	Part Number (Fits all Premium Rail Kit lengths)
Straight Rail Bracket Kit	44090DFBK

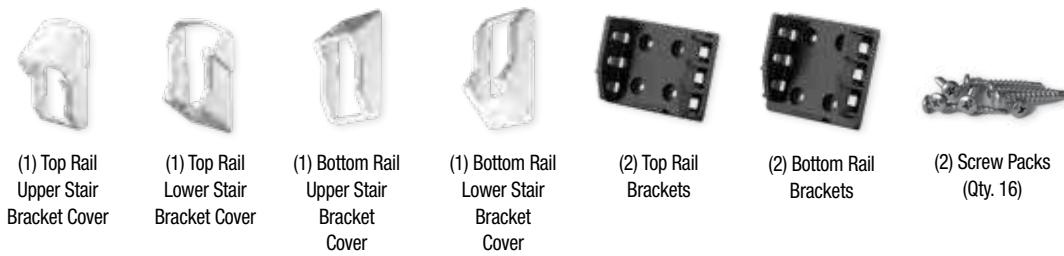

Description	Part Number (Fits all Premium Rail Kit lengths)
Stair Rail Bracket Kit	4409DFSUBK

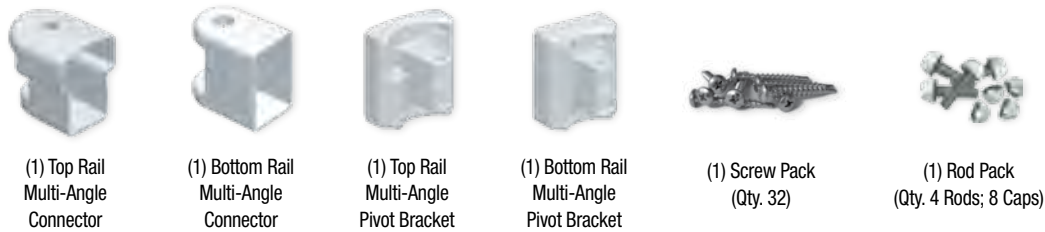

Description	Part Number (Fits all Premium rail kit lengths)
Multi-Angle Bracket Kit	44070DFMBK



Description	Part Number (Fits all Premium Rail Kit lengths)
45° Corner Post Bracket Kit	74070FFPBK

# Individual Components



Top Rail



Bottom Rail

## Straight Rails

Description	6' Rails	8' Rails	10' Rails	12' Rails
<b>For Square Spindles</b>	Actual length 72"	Actual length 96"	Actual length 120"	Actual length 144"
Top Rail	4407060STR ♦	4407080STR ♦	4407010STR ♦	4407012STR ♦
Bottom Rail	4007060SBR ♦	4007080SBR ♦	4007010SBR ♦	4007012SBR ♦
<b>For Colonial Spindles</b>	Actual length 70-1/2"	Actual length 94-1/8"	Actual length 117-3/4"	Actual length 141"
Top Rail	4407060CTR ♦	4407080CTR ♦	4407010CTR ♦	4407012CTR ♦
Bottom Rail	4007060CBR ♦	4007080CBR ♦	4007010CBR ♦	4007012CBR ♦

## Stair Rails

Description	6' Rails	8' Rails	10' Rails	12' Rails
<b>For Square or Colonial Spindles</b>	Actual length 78"	Actual length 102"	Actual length 126"	
Top Rail	4407060SSR ♦	4407080SSR ♦	4407010SSR ♦	—
Bottom Rail	4007060SLR ♦	4007080SLR ♦	4007010SLR ♦	—



Colonial Spindle



Square Spindle

## Spindles

Description	6' Rails	8', 10', and 12' Rails
<b>For 36" Rail Height</b>	Actual height 33-1/2"	Actual height 32-3/4"
Square Spindles	40043305SS ♦	44043275SS ♦
Colonial Spindles	40043305CS ♦	44043275CS ♦
<b>For 42" Rail Height</b>	Actual height 39-1/2"	Actual height 38-3/4"
Square Spindles	40043905SS ♦	44043875SS ♦

♦ Special order.

Parts may be required to ship LTL (less than truckload) based on size and overall dimensions.

# QuickPost® Porch Post



## Structural Post with Lifetime Finish

QuickPost synthetic porch posts are the perfect complement to our rail systems. Featuring the same lifetime finish as all Rail system components, the vibrant color is virtually maintenance free and never needs to be painted.

- Structural post with steel insert.
- Traditional Colonial or modern square detail.
- Trim to fit your project.
- Designed for use with rail systems.
- Virtually maintenance free.
- Lifetime limited warranty.

## Product Details

- Shell is composed of UV-protected vinyl.
- Internal core includes a structural, galvanized steel tube.
- Kit includes mounting plates and screws.

## Product Options

- Sizes: 5" and 6" are nominal for Colonial styles.
- Sizes: 4" and 5" are actual for Square styles.
- Finish colors: White.
- Accessories: Trim Kit available (sold separately).

## QuickPost Porch Post

Colonial Porch Post	5" x 5" Colonial	6" x 6" Colonial	
	Actual Width	4-1/4"	5-1/4"
	Load-Bearing Capacity	3,000#	5,000#
	104" Post Height	40500588CL	40500688CL

Square Porch Post	4" x 4" Square	5" x 5" Square	
	Actual Width	4"	5"
	Load-Bearing Capacity	3,000#	5,000#
	104" Post Height	40500488SQ	40500588SQ

## QuickPost Trim Kits (sold separately from post)

Colonial Cap & Base Kit	5" Kit fits 5" x 5" Colonial	6" Kit fits 6" x 6" Colonial
	40020505TK ♦	400600PWTk

Square Cap & Base Kit	4" Kit fits 4" x 4" Square	5" Kit fits 5" x 5" Square
	405004SQTK	405005SQTK

Note: Cap and base included in kit part code.

♦ Special order.

Note: See your Fypon seller or visit [www.fypon.com](http://www.fypon.com) for details on limited warranties and exclusions.

Note: Dimensional drawings are approximate representations. Do not scale.

Parts may be required to ship LTL (less than truckload) based on size and overall dimensions.

# DuraPoly® Porch Post



Paintable finish allows for unique customization to match any decor.

## DuraPoly Porch Post

Colonial Porch Post	5" x 5" Colonial	6" x 6" Colonial	
	Actual Width	4-1/4"	5-1/4"
	Load-Bearing Capacity	3,000#	5,000#
	95-7/8" Post Height	80500508CL	80500608CL
	103-7/8" Post Height	80500588CL	80500688CL



## DuraPoly Trim Kits (sold separately from post)

Colonial Cap & Base Kit	5" Kit fits 5" x 5" Colonial	6" Kit fits 6" x 6" Colonial
	800500PWTK	800600PWTK

Note: Cap and base included in kit part code.



# Balustrades, Porch Posts & Columns



## ADD OUTDOOR SOPHISTICATION.

Transform any porch, patio or balcony into an impressive outdoor living area. An eye-catching accent for many home designs, our balustrades, porch posts and columns are beautiful and durable.





Balusters .....	237
Top Rails .....	244
Bottom Rails .....	245
Installation Aids .....	246
Newel Posts .....	248
Post Accessories .....	250
Porch Spandrels .....	252
Structural Column .....	252
Structural Porch Posts .....	253
Wood-Grained Column .....	255
Stone Balustrade System .....	256
Stone Half-Round Column .....	257

**Product Shown:**  
 Square Baluster  
 Top Straight Rail  
 Bottom Straight Rail  
 Plain Newel Post  
 Flat Post Top  
 Trim Collar  
 Rail Support Block



# Balustrades, Porch Posts & Columns

---

## HOW TO ORDER

### Balustrade Systems

Our smooth balustrades are available in three systems: 5", 7" and 12". This size designates the width of the top and bottom rail. In addition to these three sizes, we offer a stone-textured system, which has a 6" wide top and bottom rail.

### Planning Your Layout

#### **Balusters**

For each baluster, we have noted a center spacing dimension. This is the maximum center-to-center distance between balusters that does not allow a 4" ball to pass through at any point. The number of balusters you need can be found by dividing the rail span, in inches, by the center spacing dimension shown under each part.

**Note: When dividing gives you a fractional result, always round up to the next whole number as shown in the example.**

#### **Rail Installation Kits**

Each rail section (span between two newel posts) will require two Rail Installation Kits. Rail Installation Kits will connect both ends of one rail to a newel post or column.

**Note: Rail Installation Kits will not work on stair applications. Top and bottom rails do not come pre-drilled.**

#### **Newel Posts**

Each newel post will require one Newel Post Installation Kit to anchor the base of the post, as well as any post tops, balls or trim collars desired.

### Balustrade System Accessories

Balustrade system accessories are available to help achieve your desired look. All balustrade accessories are unattached and must be ordered separately.

### Structural Porch Posts & Columns

Structural porch posts and columns are reinforced and have load-bearing capacities as noted. Installation hardware is included. Simply choose the column or porch post desired in a height that is equal to or slightly larger than the required height. Porch posts and columns can be trimmed to various lengths without impacting load rating. Be sure to order the appropriate quantity of porch posts and columns to adequately support the weight of the load they will carry.

**Always consult the local building code authority to determine suitability of products to meet specific project requirements.**



## BALUSTER EXAMPLE

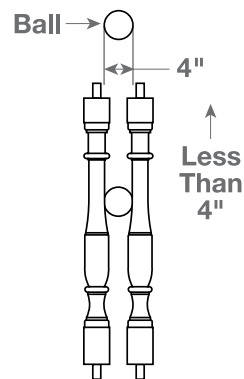

BAL3X20CC – Requires 5" on center spacing

Rail Span ÷ Center Spacing =  
No. of Balusters Needed

$$96" \div 5" = 19.2$$

(Round up to 20)

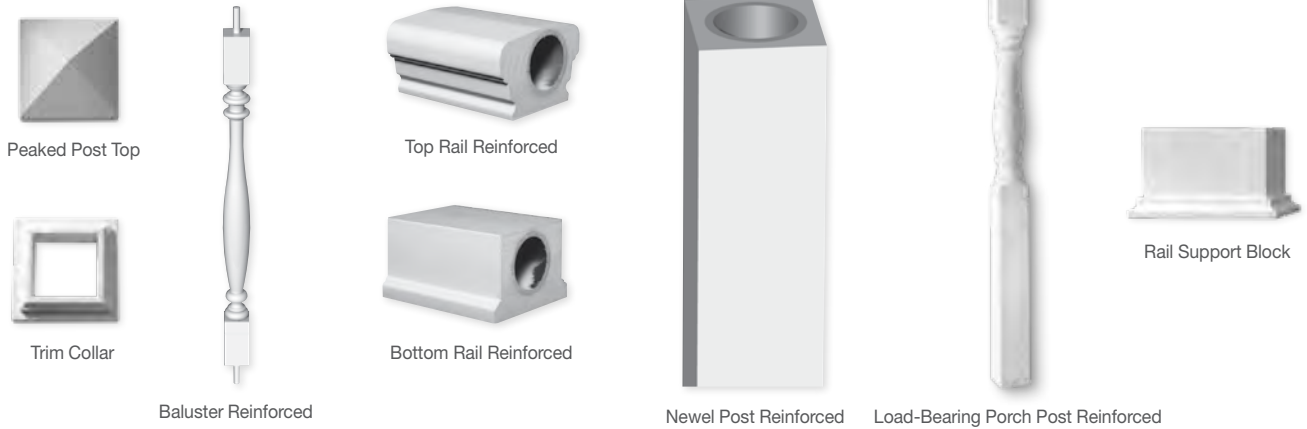
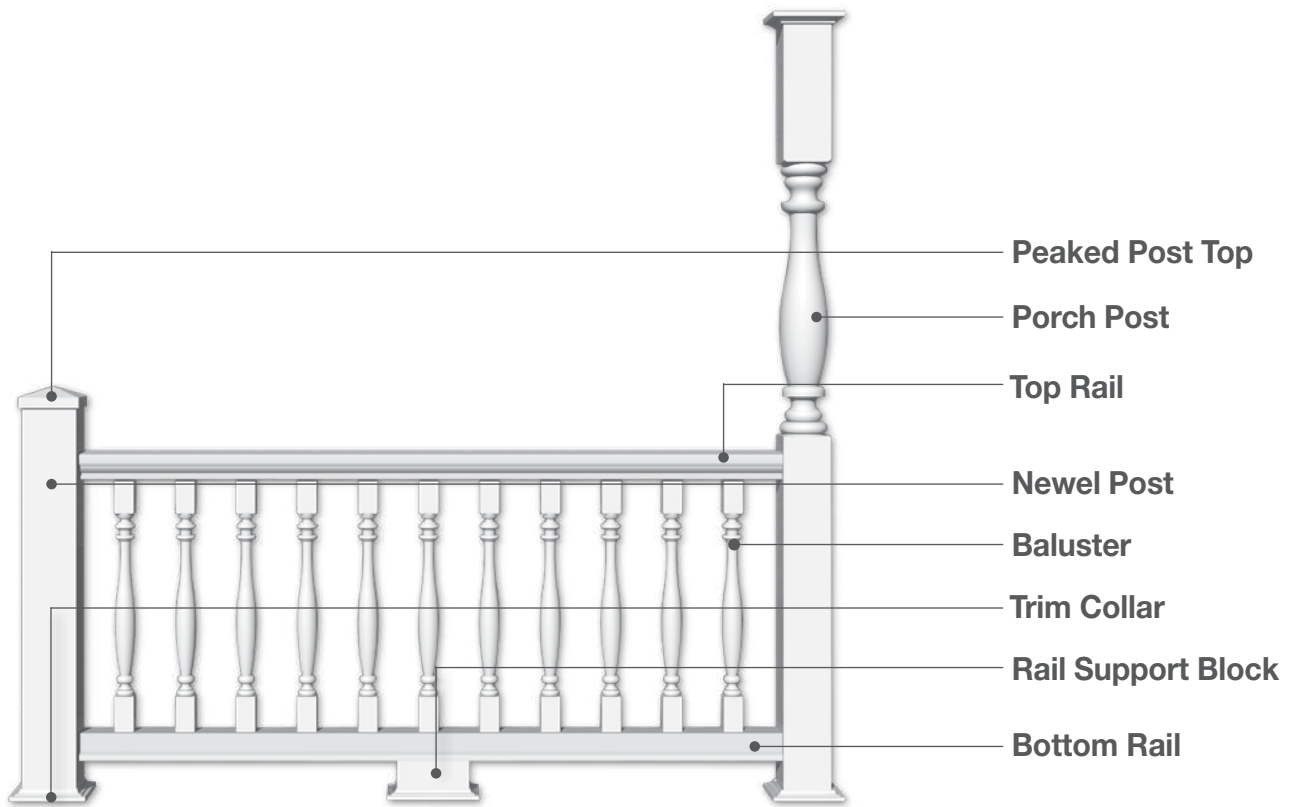

# Ashley Baluster

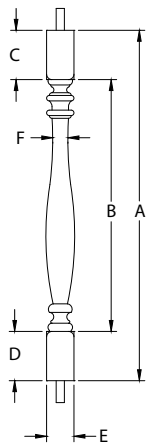

Part Number	Balustrade Rail System	A	B	C	D	E	F	Maximum Center-to-Center Distance
BAL2.5X15AY	5"	15"	9"	3"	3"	2-1/2"	1-7/8"	5-7/8"
BAL3X20AY	5"	20"	15"	2-1/2"	2-1/2"	2-1/2"	1-1/2"	5-3/8"
BAL3X24AY	5"	24"	15"	4-1/2"	4-1/2"	2-1/2"	1-3/8"	5-3/8"
BAL3X28AY	5"	28"	19"	4-1/2"	4-1/2"	2-1/2"	1-3/8"	5-3/8"
BAL3X32AY	5"	32"	23"	4-1/2"	4-1/2"	2-1/2"	1-3/8"	5-3/8"
BAL3X36AY	5"	36"	24"	6"	6"	2-1/2"	1-1/4"	5-1/4"
BAL4X24AY	7"	24"	15"	4-1/2"	4-1/2"	4-1/2"	3-1/2"	7-3/8"
BAL5X24AY	7"	24"	17"	3-1/2"	13-1/2"	4-1/2"	3-1/2"	7-3/8"
BAL5X32AY	7"	32"	23"	4-1/2"	4-1/2"	4-1/2"	3-3/8"	7-3/8"



Note: Made of polyurethane material.

Note: Baluster images shown may not be an accurate representation of every size within each category. For additional line art images, visit [fypon.com](http://fypon.com). Parts may be required to ship LTL (less than truckload) based on size and overall dimensions.



## Beaumont Baluster

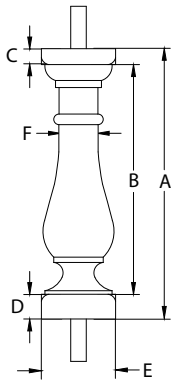

Part Number	Balustrade Rail System	A	B	C	D	E	F	Maximum Center-to-Center Distance
BAL4X22BE	7"	22"	19-1/8"	1-1/8"	1-3/4"	4"	2-3/8"	6-1/4"
BAL5X19BE	7", 12"	19-1/8"	16-1/4"	1-1/8"	1-3/4"	5-1/4"	2-3/4"	6-3/4"
BAL5X22BE	7", 12"	22"	16-1/8"	2-1/8"	3-3/4"	5"	3-1/4"	7-1/8"
BAL5X31BE	12"	31"	24-7/16"	2-1/2"	4-1/8"	5-3/4"	2-7/8"	6-1/8"
BAL6X22BE	12"	21-7/8"	16-1/8"	2-1/8"	3-3/4"	6-1/4"	4"	8"

# Classic Baluster

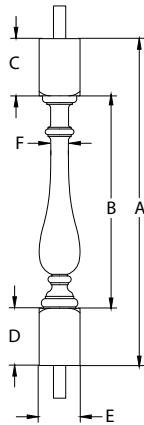

Part Number	Balustrade Rail System	A	B	C	D	E	F	Maximum Center-to-Center Distance
BAL3X20CC	5"	20"	13"	3-1/2"	3-1/2"	2-1/2"	1-1/8"	5"
BAL3X24CC	5"	24"	17"	3-1/2"	3-1/2"	2-1/2"	1-1/8"	5"
BAL3X28CC	5"	28"	21"	3-1/2"	3-1/2"	2-1/2"	1"	5"
BAL3X32CC	5"	32"	25"	3-1/2"	3-1/2"	2-1/2"	1-1/8"	5-1/8"
BAL5X20CC	7"	20"	10"	5"	5"	5"	3-5/8"	7-5/8"
BAL5X24CC	7"	24"	14"	5"	5"	5"	3-5/8"	7-5/8"
BAL5X28CC	7"	28"	18"	5"	5"	5"	3-1/2"	7-1/2"
BAL5X30CC	7"	30-1/2"	20-1/2"	5"	5"	5"	3-5/8"	7-1/2"
BAL5X32CC	7"	32"	22"	5"	5"	5"	3-1/2"	7-1/2"
BAL4X27CCOB	7"	27"	19"	4"	4"	4-1/4"	1-7/8"	5-3/4"
BAL4X31CCOB	7"	31"	23"	4"	4"	4-1/4"	1-1/2"	5-3/4"
BAL5X28CCOB	7"	28"	21-1/8"	3-3/8"	3-3/8"	4-1/2"	2"	5-7/8"
BAL7X28CC	12"	28"	16"	6"	6"	7"	5-1/2"	9-3/8"
BAL7X28CCOB	12"	28"	21-1/4"	3-5/8"	3-3/8"	7"	3-5/8"	7-1/2"

Note: Baluster images shown may not be an accurate representation of every size within each category. For additional line art images, visit [fypon.com](http://fypon.com). Parts may be required to ship LTL (less than truckload) based on size and overall dimensions.

## Logan Baluster

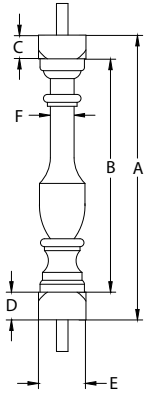

Part Number	Balustrade Rail System	A	B	C	D	E	F	Maximum Center-to-Center Distance
BAL3X24LN	5"	24"	18"	3"	3"	3"	1-1/2"	5-1/2"
BAL3X28LN	5"	28"	22"	3"	3"	3"	1-1/2"	5-1/2"

## Rosedale Baluster

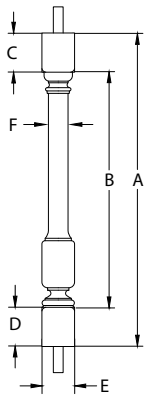

Part Number	Balustrade Rail System	A	B	C	D	E	F	Maximum Center-to-Center Distance
BAL5X20RL	7", 12"	20"	12"	4"	4"	4-1/2"	2-3/4"	6-5/8"



# Woodruff Baluster

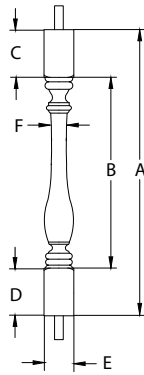

Part Number	Balustrade Rail System	A	B	C	D	E	F	Maximum Center-to-Center Distance
BAL3X18WF	5"	18"	10"	4"	4"	2-1/2"	1-3/8"	5-1/2"
BAL3X20WF	5"	20"	12"	4"	4"	2-1/2"	1-1/4"	5-1/4"
BAL3X24WF	5"	24"	16"	4"	4"	2-1/2"	1-1/4"	5-1/8"
BAL3X28WF	5"	28"	20"	4"	4"	2-1/2"	1-1/4"	5-1/8"
BAL3X32WF	5"	32"	24"	4"	4"	2-1/2"	1-1/4"	5-1/8"
BAL3X36WF	5"	36"	28"	4"	4"	2-1/2"	1-1/2"	5-1/8"
BAL5X24WF	7", 12"	24"	16"	4"	4"	4-1/2"	3-1/4"	7-1/8"
BAL5X28WF	7", 12"	28"	20"	4"	4"	4-1/2"	3-1/2"	7-1/8"
BAL5X32WF	7", 12"	32"	24"	4"	4"	4-1/2"	3-1/2"	7-1/8"



Note: Baluster images shown may not be an accurate representation of every size within each category. For additional line art images, visit [fypon.com](http://fypon.com). Parts may be required to ship LTL (less than truckload) based on size and overall dimensions.

# Square Baluster

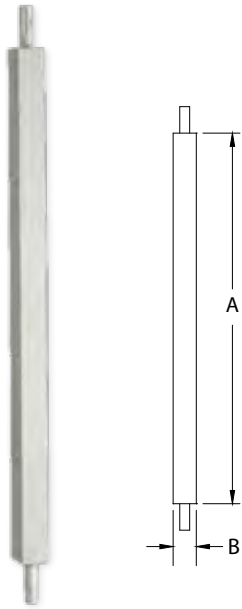



Part Number	Balustrade Rail System	Height (A)	Width (B)	Maximum Center-to-Center Distance
BAL2X20SQ	5"	20"	1-3/4"	5-3/4"
BAL2X24SQ	5"	24"	1-3/4"	5-3/4"
BAL2X28SQ	5"	28"	1-3/4"	5-3/4"
BAL2X32SQ	5"	32"	1-3/4"	5-3/4"



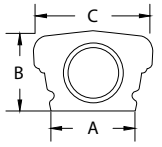

# Top Straight Rails

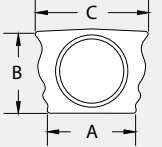
Top Rail	Part Number	Balustrade Rail System	Length	A	B	C	
	BTR5X96	5"	96"	3-1/4"	3-1/8"	4-5/8"	
	BTR5X144*	5"	144"	3-1/4"	3-1/8"	4-5/8"	
	BTR7X96	7"	96"	5-1/2"	5-1/4"	7"	
	BTR7X120*	7"	120"	5-1/2"	5-1/4"	7"	
	BTR7X144*	7"	144"	5-1/2"	5-1/4"	7"	



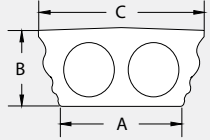

# Top Straight Rails

Top Rail	Part Number	Balustrade Rail System	Length	A	B	C
	BTR12X96	12"	96"	9"	5-1/4"	11-7/8"
	BTR12X120*	12"	120"	9"	5-1/4"	11-7/8"
	BTR12X144*	12"	144"	9"	5-1/4"	11-7/8"



# Bottom Straight Rails



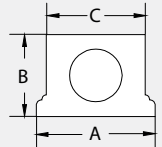
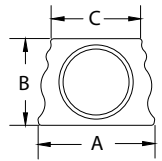
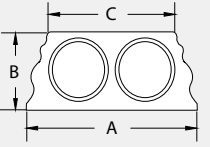

Bottom Rail	Part Number	Balustrade Rail System	Length	A	B	C
	BBR5X96	5"	96"	4-1/2"	3-1/8"	3-3/4"
	BBR5X144*	5"	144"	4-1/2"	3-1/8"	3-3/4"
	BBR7X96	7"	96"	7"	5-1/4"	5-1/2"
	BBR7X120*	7"	120"	7"	5-1/4"	5-1/2"
	BBR7X144*	7"	144"	7"	5-1/4"	5-1/2"
	BBR12X96	12"	96"	11-7/8"	5-1/4"	9"
	BBR12X120*	12"	120"	11-7/8"	5-1/4"	9"
	BBR12X144*	12"	144"	11-7/8"	5-1/4"	9"

\*Maximum rail span distance for field applications is 96".  
Parts may be required to ship LTL (less than truckload) based on size and overall dimensions.

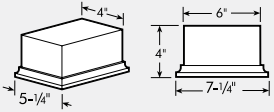

## Balustrade Rail Installation Aids

Part Number	Balustrade System	Installation Notes
 RSB4X4X6 Rail Support Block	5", 7", 12"	Install under the bottom rail at a span of 48" or less. Dimensions: 4" x 4" x 7-1/4" (may be trimmed for height). 
 BRK5 Rail Installation Kit	5"	Connects both ends of one 5" top or bottom rail to support structure. Order two kits per section. <b>Kit Contents:</b> (2) Angle Brackets & Mounting Hardware
 BRK6-7 Rail Installation Kit	7"	Connects both ends of one 7" top or bottom rail to support structure. Order two kits per section. <b>Kit Contents:</b> (2) Angle Brackets & Mounting Hardware
 BRK12 Rail Installation Kit	12"	Connects both ends of one 12" top or bottom rail to 12" newel post or other support. Order two kits per section. <b>Kit Contents:</b> (2) Bear Claw Brackets & Mounting Hardware
 BRK12ANGLBKT Rail Installation Kit	12"	Connects both ends of one 12" top or bottom rail to 13" newel post only. Order two kits per section. <b>Kit Contents:</b> (4) Angle Brackets & Mounting Hardware

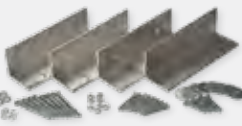

# Plain Newel Post

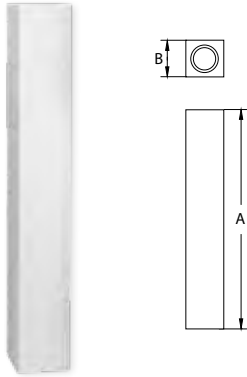

Part Number	Balustrade System	A	B	Accessories	Installation Kit
NP6X48	5"	48"	5-1/2"	PST6X6FP PST7X7F TC6	NPK400
NP8X48	7"	48"	7-1/2"	PST8X8FP PST10X10F TC8	NPK600

# Decorative Newel Post

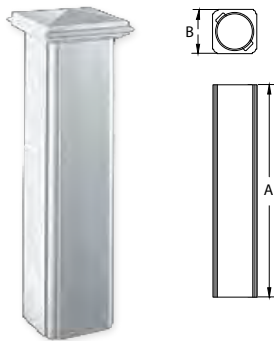

Part Number	Balustrade System	A	B	Accessories	Installation Kit
NP10X48	7"	48"	10"	PST11X11FP	NPK10



# Corner Panel Newel Post

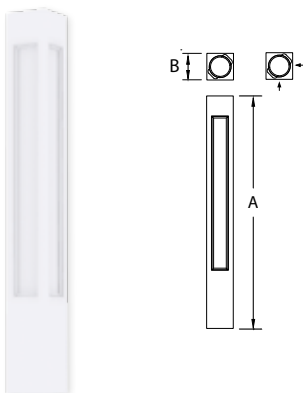

Part Number	Balustrade System	A	B	Accessories	Installation Kit
NPCP8X48	7"	48"	8"	PST9X9FP PST10X10F TC8-8	NPK600
NPCP13X48	12"	48"	12-1/2"	PST13X13FP PST14X14F	NPK13



# Straight Panel Newel Post

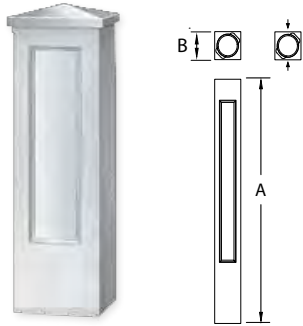

Part Number	Balustrade System	A	B	Accessories	Installation Kit
NPSP8X48	7"	48"	8"	PST9X9FP PST10X10F TC8-8	NPK600
NPSP13X48	12"	48"	12-1/2"	PST13X13FP PST14X14F	NPK13

# Plain Three-Piece Newel Post

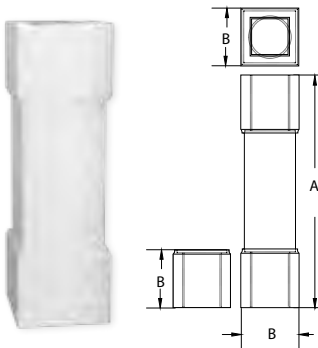

Part Number	Balustrade System	A	B	Accessories	Installation Kit
NP12X48	12"	48"	12"	PST13X13F PST13X13FP	NPK12



## Newel Post Installation Kits

Newel Post Installation Kits are sold separately from the newel posts. Fasteners to mount steel base plate to the floor surface are not provided.

Installation Kit	Kit Contents
NPK10	Secures one 10" newel post to the structural substrate.
NPK12	Secures one 12" newel post to the structural substrate.
NPK13	Secures one 13" newel post to the structural substrate.
NPK400	Secures one 6" newel post to the structural substrate.
NPK600	Secures one 8" newel post to the structural substrate.

Note: Post tops shown are sold separately.  
Parts may be required to ship LTL (less than truckload) based on size and overall dimensions.

# Post Accessories

Part Number	Balustrade System	Bottom Width (A)	Top Width (B)	Height (C)	Accessories
 B5X7 Ball Top	5", 7"	4-3/8"	5-1/4"	6-3/4"	PST7X7F
B10X13 Ball Top	12"	8-1/2"	10"	12-7/8"	PST13X13F PST14X14F
 PST7X7F Flat Post Top	5"	6-1/2"	4-1/2"	1-1/2"	NP6X48
PST10X10F Flat Post Top	7"	9-1/2"	6-1/4"	2"	NP8X48 NPCP8X48 NPSP8X48
PST13X13F Flat Post Top	12"	12-1/2"	8-5/8"	1-1/2"	B10X13 NP12X48
PST14X14F Flat Post Top	12"	14"	8-3/4"	3-1/8"	B10X13 NPCP13X48 NPSP13X48

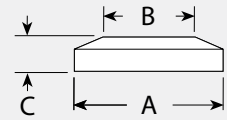
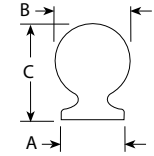





## Post Accessories

Part Number	Balustrade System	Bottom Width (A)	Top Width (B)	Height (C)	Accessories	
PST6X6FP Fancy Peaked Top	5"	5-7/8"	—	2-1/8"	NP6X48	
PST8X8FP Fancy Peaked Top	7"	8-1/8"	—	3"	NP8X48	
 PST9X9FP Fancy Peaked Top	7"	8-7/8"	—	3"	NPCP8X48 NPSP8X48	
PST11X11FP Fancy Peaked Top	7"	10-3/4"	—	4-1/2"	—	
PST13X13FP Fancy Peaked Top	12"	13-1/4"	—	4-5/8"	NP12X48 NPCP13X48 NPSP13X48	
TC6 Trim Collar	5"	9-1/8"	5-5/8"	2"	NP6X48	
 TC8 Trim Collar	7"	11-1/8"	7-5/8"	2"	NP8X48	
TC8-8 Trim Collar	7"	11-1/8"	8-1/8"	2"	NP8X48	

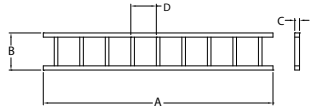

## Porch Spandrels

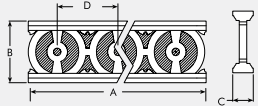
	Part Number	Length (A)	Height (B)	Projection (C)	Design Repeat (D)	
	PRS48X8	48"	7-3/4"	1"	5-1/4"	
	PRS96X8	97-1/2"	8-1/4"	2-7/8"	8-1/8"	

## Panel Square Column

Structural

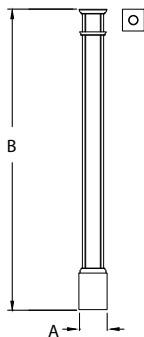

Part Number	Width	Base Width (A)	Height (B)	Base Height	Load-Bearing Capacity
COL8X96PSQ*	6-1/8"	8"	96"	13-5/8"	12,000#
COL11X96PSQ*	8"	10-1/2"	96"	13-3/4"	12,000#
COL11X108PS*	8"	10-5/8"	108"	12-3/4"	12,000#

# Vintage Porch Post

Structural

Part Number	Width (A)	Overall Height (B)	Bottom Block Height (C)	Load-Bearing Capacity	Balustrade System
PP8X120A*	7-1/2"	120"	42"	12,000#	7"

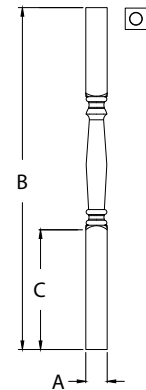

# Colonial Porch Post

Structural

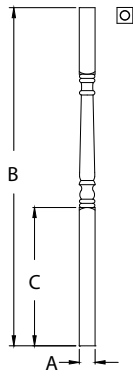

Part Number	Width (A)	Overall Height (B)	Bottom Block Height (C)	Load-Bearing Capacity	Balustrade System
PP5X102*	4-3/4"	101-1/4"	41-1/2"	6,000#	5"
PP6X96*	5-1/2"	96"	44-1/2"	6,000#	5"
PP6X108*	5-1/2"	108"	44-1/2"	6,000#	5"
PP6X120*	5-1/2"	120"	44-1/2"	6,000#	5"

# Lamp Post

Non-Structural / Decorative

Part Number	Bottom Width (A)	Top Width (B)	Height (C)	Pipe Diameter
LP6X96**	5-1/2"	3-1/2"	96"	2-7/8"

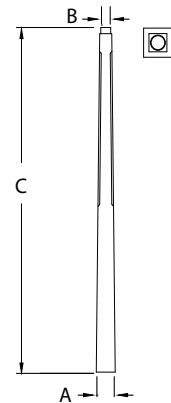

\*Installation kit included.

\*\*Non-structural pipe extends 1-3/4" beyond top of post.

Note: Porch posts can be field trimmed to various heights without losing load rating.

Parts may be required to ship LTL (less than truckload) based on size and overall dimensions.



# Structural Wood-Grained Column

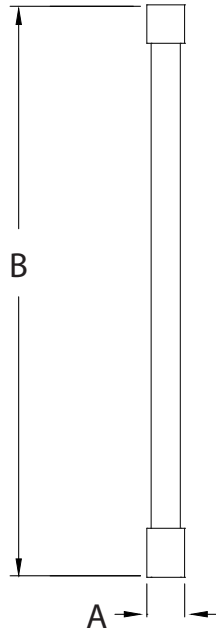

Part Number	Width (A)	Height (B)	Load Bearing Capacity
PPSQKIT6X108S*	7"	108"	12,000#



\*Installation kit included. Column can be field trimmed to various heights without losing load rating. Cap is 9-5/8" x 7" and base is 9-5/8" x 9". Parts may be required to ship LTL (less than truckload) based on size and overall dimensions.

# Stone Euro Baluster

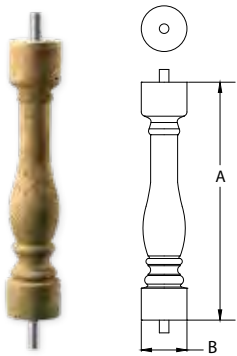

Part Number	Height (A)	Width (B)	Maximum Center-to-Center Distance
BAL5X28EUST*	27-7/8"	5-3/8"	7-5/8"

# Stone Rails

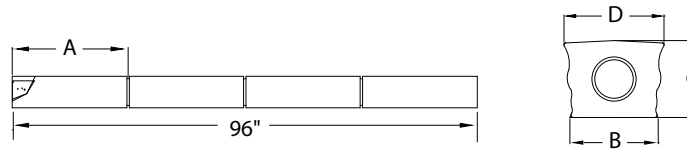

Part Number	Length	Molded Rail Section (A)	Width (B)	Height (C)	Overall Width (D)
-------------	--------	-------------------------	-----------	------------	-------------------



BTR6X96ST	96"	23-7/8"	5-3/4"	5"	6-1/2"
-----------	-----	---------	--------	----	--------

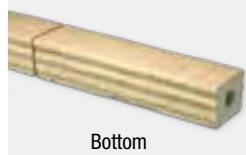

BBR6X96ST	96"	23-7/8"	5-5/8"	4-7/8"	6-1/4"
-----------	-----	---------	--------	--------	--------

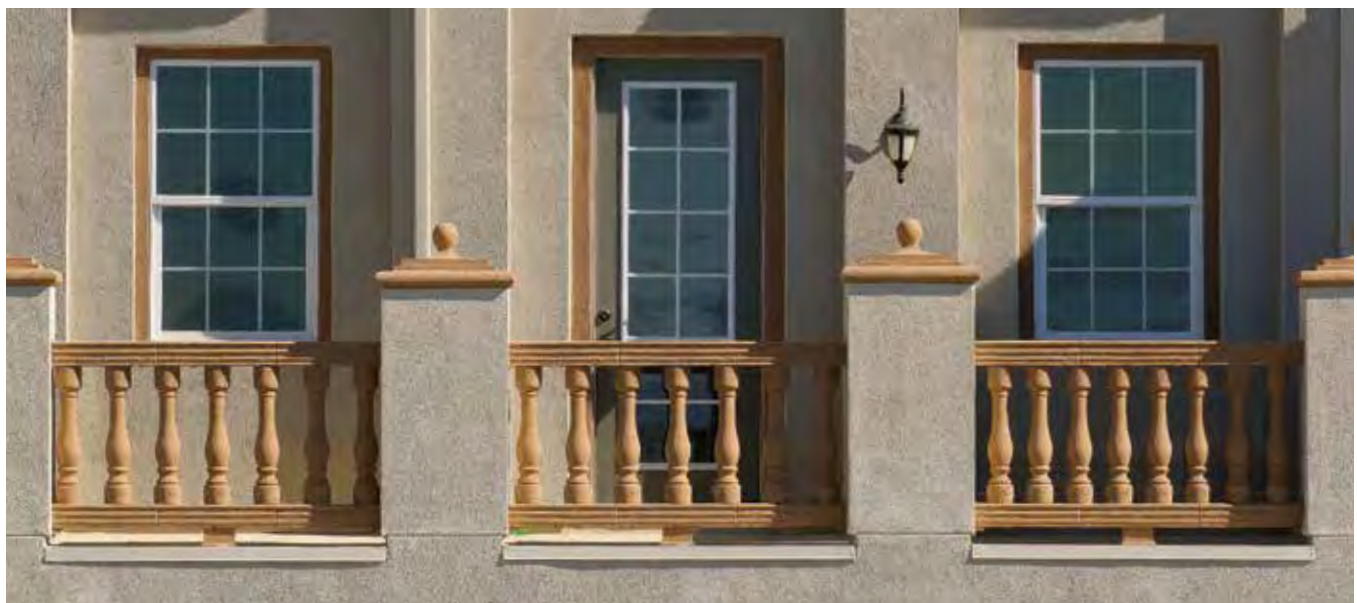

\*1-1/8" X 30-3/4" fiberglass pipe molded into baluster.

Note: Always consult the local building code authority to determine suitability of products to meet specific requirements, as well as adhesive manufacturer's recommendations for your particular climate and the substrate you are installing to.

Parts may be required to ship LTL (less than truckload) based on size and overall dimensions.



# Stone Newel Post

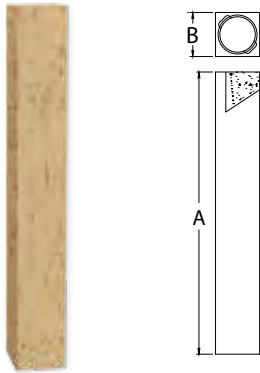

Part Number	A	B	Installation Kit	Accessories
NP8X48ST	48"	7-1/2"	NPK600	PST10X10PST

# Stone Post Cap

Part Number	A	B
 PST10X10PST	9-1/2"	3"

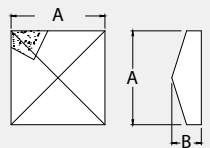

# Stone Half-Round Column

Non-Structural / Decorative

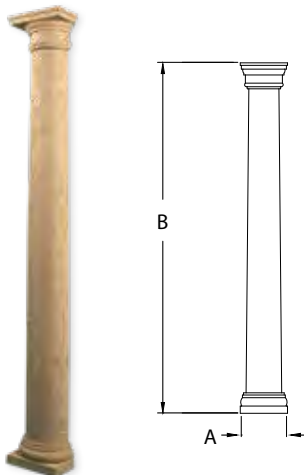

Part Number	Width (A)	Height (B)	Projection
<b>HRCBCC96X12ST</b> Tapered Kit Kit ships in 3 pieces and creates one half column. Order two kits to create a full column.	15"	110-1/4"	11-3/4"
<b>Kit Contents:</b> (1) Cap Half [CC15ST] (1) Shaft Half [HRCB96X12ST] (1) Base Half [CB15ST]			

# Fypon® Service Guidelines

---

## ORDERING & DELIVERY

### Placing Orders

- Purchase orders must be sent to Fypon by Electronic Data Interchange (EDI), fax (800.446.9373) or email (orders@fypon.com) and should include the following:
  - A valid Fypon part number from the current price list.
  - Detailed part description.
  - Quantity ordered.
  - Unit of measure (each, etc.)
  - Net price.
- Fypon will confirm all purchase orders with an order acknowledgement via EDI, unless the customer has opted not to receive acknowledgements.
- Customers should review order acknowledgements carefully for accuracy. The customer is obligated to bring order acknowledgement discrepancies to the attention of their Customer Service Representative, and failure to do so may result in disallowance of a claim.
- Ship date for each order is noted on the order acknowledgement. If the ship date changes for any reason, customers are notified via fax or email of the new ship date.

### Cancellations

- Cancellation requests must be made via purchase order sent to Fypon by EDI, fax (800.446.9373) or email (orders@fypon.com).
- The cancellation request must reference either the customer purchase order number or Fypon order number, and the line item(s) to be cancelled.
  - Cancellation requests must be received within 24 hours from receipt of the order.
  - Fypon will confirm cancellations with an order cancellation acknowledgement via EDI, fax or email.
- To service customers in our five-day ship lead time, the 24-hour cancellation policy does not apply for custom and made-to-order parts. Once the order has been acknowledged, it cannot be returned. This includes, but is not limited to the following made-to-order products: custom parts; Board and Batten, Plank, Shaker-style and Modern Farmhouse Shaker-style shutters; beams; beam accessories; beam mantels; Craftsman Cove, Craftsman Step and Distinction crossheads; and column wraps.

### Fypon Express Service

Do you need your product faster? Fypon offers an express service on available inventoried products. Contact our Customer Service Team at 800.446.3040, info@fypon.com or by fax at 800.446.9373 for details.

# CUSTOM PROJECTS, LARGE PROJECTS AND TAKEOFFS

## Placing Orders

- Request a price quote on a custom product by contacting our Custom Product Sales (CPS) Department at 855.397.6647 or CPS@fypon.com, or by filling out the Project / Custom Quote Request Form on fypon.com.
- For jobs of \$10,000 and greater, email your elevations to cps@fypon.com.
- New projects of \$30,000, which include custom parts, may qualify for a four-week lead time.
- New projects of \$50,000 or greater, consisting of stock and custom products, may qualify for a discount. Contact Customer Service at 800.446.3040 or cps@fypon.com.
- For large projects and takeoffs, our dedicated Custom Product Sales Department can assist with price quotes.
- Tools for custom product will be dispositioned within six months of last order date. Any orders after disposition of tool(s) must be requoted by CPS. Contact your Customer Service Representative for more information.

## PRODUCT RETURN POLICIES

### Freight Carrier Damage Claims

In the event of damage, the following actions are appropriate:

- Inspection must be made of each shipment upon delivery. Any damage to cartons or goods must be noted on the Bill of Lading (BOL) or Carrier Delivery Receipt (CDR) at the time of delivery and delivery should be refused.
- Claims for loss must be filed in writing via email, with a signed copy of the BOL or CDR noting damage, to fyponRGA@thermatru.com within one business day (24 hours) of delivery. Failure to do so may result in disallowance of a claim.

### Policy Returns

- Requests for policy RGA must be made within six months of delivery of goods, and submitted in writing to fyponRGA@thermatru.com.
- All requests for returned goods are subject to the following:
  - Goods must be received in good and original condition.
  - Good must be in unbroken, original packaging.
  - Restocking fees:
    - 1-90 days – minimum 20% restocking fee.
    - 91-180 days – minimum 30% restocking fee.
- Once the request has been approved, an RGA will be issued and the goods may be returned Freight Collect to the address designated on the RGA on a Fypon-approved carrier.
- Upon receipt of returned goods, Fypon will inspect the goods and issue a credit contingent on meeting the requirements of the RGA process.
- Products that have been discontinued are not eligible for return.

# Fypon® Service Guidelines

---

## PRODUCT RETURN POLICIES (CONTINUED)

### Items Not Eligible for Return or Credits

- Product that has been installed, painted or in any way modified from the original shipped condition.
- Custom or special order – including made-to-order parts. See Cancellations for list of product not eligible for returns.
- Discontinued products.

## SPECIALTY OPTIONS

### Routing and Cutting Options

- Some products can be routed with a 5/8" or 3/4" channel to accept siding J-Channel. A \$25 routing charge applies to each item or pair to be routed.
- The routing option is not available on all products.
- Fypon offers the option to cut flat trim and other lineal type product, one size cut per box, at a cost of \$50 per box.
- Contact your Customer Service Representative at 800.446.3040 for details.

## CONSIDERATIONS FOR INSTALLATION

Fypon reserves the right to make changes to surfaces that don't affect the outward appearance of our parts (these surfaces may vary with the same part number), which will not impact the look of the product once installed. If it is important to have consistency between parts for installation purposes, please speak with your Customer Service Representative prior to ordering or requesting samples.

## Warranty

Fypon will process claims for installed product under the following guidelines:

- Warranty requests from homeowners or end-use customers should be processed at the local dealer to determine if there are any installation problems. This may require an initial field inspection by a dealer representative.
- Warranty issues that are determined by the dealer to be a quality defect should file a claim with Fypon.
- Claims requests should include:
  - Inspection details.
  - Photos.
  - Original purchase order number and date.
  - Proof of home ownership.
- Upon receipt of returned goods, Fypon will inspect the goods and issue a credit contingent on meeting the requirements of the RGA process.
- Products that have been discontinued are not eligible for return.



# NATIONWIDE Everyday Flat Rate Shipping

INCLUDES SMOOTH, WOOD-GRAINED, COLUMN WRAP & RAIL PRODUCTS

## All Orders\*

PRODUCT  
UNDER 8'  
**\$25**

PRODUCT 8'  
OR LONGER  
**\$125**

ORDERS  
\$2,000 LIST  
& OVER  
**FREE**

\*Exceptions apply. See Beam Freight Policy for details.

## Adhesive & Finishing

A urethane-based adhesive such as Loctite® PL Premium® Construction Adhesive\* must be used on all joints when installing urethane products. This will minimize the effects of expansion and contraction on the product. For additional information on adhesives, detailed installation instructions and finishing information, visit [fypon.com](http://fypon.com).

## Loctite® PL Premium® Adhesive

	Part Number	Description
	ADH1 Loctite PL Premium Adhesive	(1) 10.2 oz. Cartridge

## Considerations for Installation

Fypon reserves the right to make changes to our product with the assurance that we will meet or exceed quality requirements. Changes to product could include standardization across parts that may impact blocking applications, but visual impact will not be noticeable and parts will align. If it is critical to have consistency between parts for installation purposes, please speak with your Customer Service Representative prior to placing your order at 800-446-3040.

Material Comparison	Fypon Polyurethane	Wood	Composite
May Be Placed Against Masonry	YES	NO	NO
Above-Grade Distance Requirement**	0"	8"	6"
Water Absorption	NO	YES	YES
Insect Resistant	YES	NO	NO
Moisture Resistant	YES	NO	NO
Pre-Drilling Required When Edge Nailing	NO	YES	YES
Requires Sanding, Priming & Sealing	NO	YES	YES
Painting (Number of Coats Needed)***	1	2	2
Quality	Consistent quality, no waste; consistent finish	Natural variation; must be culled	
Versatility**	Suitable options for interior or exterior application	Different grade of material and finish required for outdoor use	

## Finishing Touches

### Primer Color Match Available at Sherwin-Williams

To better service our customers nationwide, we have worked with Sherwin-Williams\* to formulate a color and sheen match for our factory-applied primer.

#### Fypon® White:

Resilience® Exterior Latex\*  
Product # K42W51  
Sheen: Flat  
Base: Extra White  
No colorant needs to be  
added to the formula.

#### Fypon® Oatmeal:

Resilience® Exterior Latex\*  
Product # K43W0053  
Sheen: Satin  
Base: Deep Base  
Quart and gallon formulas  
are shown below.

#### Quart Formula

W1 – White 4/32, 1/64  
B1 – Black 7/32, 1/64, 1/128  
R2 – Maroon 4/32  
Y3 – Deep Gold 15/32, 1/64, 1/128

#### Gallon Formula

W1 – White 18/32  
B1 – Black 31/32, 1/128  
R2 – Maroon 15/32, 1/64  
Y3 – Deep Gold 63/32

#### Fypon® Black Primer:

SHER-WOOD® ACR: Millwork Primer\*  
Product # E60BP102

\*Marks denoted by (\*) asterisk are owned by third parties.

· Loctite® PL Premium® is owned by Henkel IP & Holding GmbH.

· Sherwin-Williams is owned by SWMC, Inc.

\*\*Always consult the local building code authority to determine suitability of products to meet specific requirements, as well as adhesive manufacturer's recommendations for your particular climate and the substrate you are installing to.

\*\*\*Fypon product must be painted within 90 days of installation or warranty is void.

PART NUMBER	PAGE	DESCRIPTION
40020505TK	230	QUICKPOST TRIM KIT WHT
40040404NC	227	QR POST NEW ENGLAND CAP WHT
40040404PB	227	QR POST NEW ENGLAND BASE WHT
40040404TC	227	QR POST TAPER CAP WHT
40040505NC	227	QR POST NEW ENGLAND CAP WHT
40040505PB	227	QR POST NEW ENGLAND BASE WHT
40040505TC	227	QR POST TAPER CAP WHT
40043305SS	229	QR SQUARE SPINDLE WHT
40043905SS	229	QR SQUARE SPINDLE WHT
40043305CS	229	QR COLONIAL SPINDLE WHT
40050408PS	227	QR POST SLEEVE WHT
40050409PS	227	QR POST SLEEVE WHT
40050438PK	226	QR COMPLETE POST KIT WHT
40050438PS	227	QR POST SLEEVE WHT
40050444PK	226	QR COMPLETE POST KIT WHT
40050444PS	227	QR POST SLEEVE WHT
40050448PS	227	QR POST SLEEVE WHT
40050460PS	227	QR POST SLEEVE WHT
40050508PS	227	QR POST SLEEVE WHT
40050509PS	227	QR POST SLEEVE WHT
40050538PS	227	QR POST SLEEVE WHT
40050538PK	226	QR COMPLETE POST KIT WHT
40050544PS	227	QR POST SLEEVE WHT
40050544PK	226	QR COMPLETE POST KIT WHT
4005ACQHDR	226	QR HARDWARE FOR POST KIT
400600PWTk	230	QUICKPOST TRIM KIT WHT
4007010CBB	229	QR BOTTOM RAIL FOR COLONIAL SPINDLE WHT
4007010SBB	229	QR BOTTOM RAIL FOR SQUARE SPINDLE WHT
4007010SLR	229	QR BOTTOM STAIR RAIL FOR COL/SQR SPINDLE WHT
4007012CBB	229	QR BOTTOM RAIL FOR COLONIAL SPINDLE 141IN WHT
4007012SBB	229	QR BOTTOM RAIL FOR SQUARE SPINDLE 141IN WHT
4007060CBB	229	QR BOTTOM RAIL FOR COLONIAL SPINDLE 70-1/2IN WHT
4007060SBB	229	QR BOTTOM RAIL FOR SQUARE SPINDLE 72IN WHT
4007060SLR	229	QR BOTTOM STAIR RAIL FOR COL/SQR SPINDLE 78IN WHT
4007080CBB	229	QR BOTTOM RAIL FOR COLONIAL SPINDLE 94-1/8IN WHT
4007080SBB	229	QR BOTTOM RAIL FOR SQUARE SPINDLE 96IN WHT
4007080SLR	229	QR BOTTOM STAIR RAIL FOR COL/SQR SPINDLE 102IN WHT
40500488SQ	230	PVC SQUARE QUICKPOST WHT
405004SQTK	230	QUICKPOST TRIM KIT WHT
40500588CL	230	PVC COLONIAL QUICKPOST WHT
40500588SQ	230	PVC SQUARE QUICKPOST WHT
405005SQTK	230	QUICKPOST TRIM KIT WHT
40500688CL	230	PVC COLONIAL QUICKPOST WHT
44043275CS	229	QR COLONIAL SPINDLE WHT
44043275SS	229	QR SQUARE SPINDLE WHT
44043875SS	229	QR SQUARE SPINDLE WHT

PART NUMBER	PAGE	DESCRIPTION
4407010CTR	229	QR TOP RAIL FOR COLONIAL SPINDLE WHT
4407010SSR	229	QR DLX STAIR RAIL COL/SQR SPINDLE WHT
4407010STR	229	QR TOP RAIL FOR SQUARE SPINDLE WHT
4407012CTR	229	QR TOP RAIL FOR COLONIAL SPINDLE WHT
4407012STR	229	QR TOP RAIL FOR SQUARE SPINDLE WHT
4407060CTR	229	QR TOP RAIL FOR COLONIAL SPINDLE WHT
4407060SSR	229	QR TOP STAIR RAIL COL/SQR SPINDLE WHT
4407060STR	229	QR TOP RAIL FOR SQUARE SPINDLE WHT
4407080CTR	229	QR TOP RAIL FOR COLONIAL SPINDLE WHT
4407080SSR	229	QR TOP STAIR RAIL COL/SQR SPINDLE WHT
4407080STR	229	QR TOP RAIL FOR SQUARE SPINDLE WHT
44070DFMBK	228	QR BRACKET KIT MULTI-ANGLE WHT
440900DFBK	228	QR BRACKET KIT STRAIGHT WHT
4409DFSUBK	228	BRACKET KIT STAIR WHT
4436CLDFGK	225	GATE KIT DLX W/COLONIAL SPINDLE WHT
4436SQDFGK	225	GATE KIT DLX W/SQUARE SPINDLE WHT
4442SQDFGK	225	GATE KIT DLX W/SQUARE SPINDLE WHT
70050438CPK	226	QR ULTRAPOST KIT - CONCRETE WHT
70050438WPK	226	QR ULTRAPOST KIT - WOOD/COMP WHT
70050444CPK	226	QR ULTRAPOST KIT - CONCRETE WHT
70050444WPK	226	QR ULTRAPOST KIT - WOOD/COMP WHT
740636CLDF	224	QR RAIL KIT DLX W/COLONIAL SPINDLE WHT
740636CLDS	225	QR STAIR KIT DLX W/COLONIAL SPINDLE WHT
740636SQDF	224	QR RAIL KIT DLX W/SQUARE SPINDLE WHT
740636SQDS	225	QR STAIR KIT DLX W/SQUARE SPINDLE WHT
740642SQDF	224	QR RAIL KIT DLX W/SQUARE SPINDLE WHT
740642SQDS	225	QR STAIR KIT DLX W/SQUARE SPINDLE WHT
74070FFPBK	228	ADAPTOR KIT 45 DEG CORNER WHT
740836CLDF	224	QR RAIL KIT DLX W/COLONIAL SPINDLE WHT
740836CLDS	225	QR STAIR KIT DLX W/COLONIAL SPINDLE WHT
740836SQDF	224	QR RAIL KIT DLX W/SQUARE SPINDLE WHT
740836SQDS	225	QR STAIR KIT DLX W/SQUARE SPINDLE WHT
740842SQDF	224	QR RAIL KIT DLX W/SQUARE SPINDLE WHT
740842SQDS	225	QR STAIR KIT DLX W/SQUARE SPINDLE WHT
741036CLDF	224	QR RAIL KIT DLX W/COLONIAL SPINDLE WHT
741036CLDS	225	QR STAIR KIT DLX W/COLONIAL SPINDLE WHT
741036SQDF	224	QR RAIL KIT DLX W/SQUARE SPINDLE WHT
741036SQDS	225	QR STAIR KIT DLX W/SQUARE SPINDLE WHT
741042SQDF	224	QR RAIL KIT DLX W/SQUARE SPINDLE WHT
741042SQDS	225	QR STAIR KIT DLX W/SQUARE SPINDLE WHT
741236CLDF	224	QR RAIL KIT DLX W/COLONIAL SPINDLE WHT
741236SQDF	224	QR RAIL KIT DLX W/SQUARE SPINDLE WHT
741242SQDF	224	QR RAIL KIT DLX W/SQUARE SPINDLE WHT
80500508CL	231	DURAPOLY COLONIAL POST 5" X 5"
80500588CL	231	DURAPOLY COLONIAL POST 5" X 5"
80500608CL	231	DURAPOLY COLONIAL POST 6" X 6"

PART NUMBER	PAGE	DESCRIPTION
80500688CL	231	DURAPOLY COLONIAL POST 6" X 6"
800500PWTK	231	DURAPOLY POST TRIM KIT 5"
800600PWTK	231	DURAPOLY POST TRIM KIT 6"
<b>A</b>		
ADH1	262	ADHESIVE PL PREMIUM CARTRIDGE
AFR10	183	FINIAL ACORN FULL ROUND SMOOTH
AP56	42	PEDIMENT ACORN SMOOTH
AP61	42	PEDIMENT ACORN SMOOTH
AP86	42	PEDIMENT ACORN SMOOTH
AP91	42	PEDIMENT ACORN SMOOTH
AP98	42	PEDIMENT ACORN SMOOTH
AP115	42	PEDIMENT ACORN ADJ SMOOTH
AP667	42	PEDIMENT ACORN SMOOTH
AR24X4F	51	TRIM HALF ROUND ARCH FLAT SMOOTH
AR36X10MC	52	TRIM HALF RND ARCH DECO W/END CAP SMOOTH
AR36X10MFL108	53	TRIM HALF RND ARCH DECO W/FLANK SMOOTH
AR36X10SK	44	PEDIMENT HALF RND SNBST W/T & KEY SMOOTH
AR36X4F	51	TRIM HALF ROUND ARCH FLAT SMOOTH
AR36X4M	51	TRIM HALF ROUND ARCH DECORATIVE SMOOTH
AR36X6F	52	TRIM HALF ROUND ARCH FLAT SMOOTH
AR36X6M	52	TRIM HALF ROUND ARCH DECORATIVE SMOOTH
AR37X4F	51	TRIM HALF ROUND ARCH FLAT SMOOTH
AR40X54PSK	44	PEDIMENT HALF RND SNBST W/T & KEY SMOOTH
AR40X6M	52	TRIM HALF ROUND ARCH DECORATIVE SMOOTH
AR48X4F	51	TRIM HALF ROUND ARCH FLAT SMOOTH
AR48X4M	51	TRIM HALF ROUND ARCH DECORATIVE SMOOTH
AR48X6F	52	TRIM HALF ROUND ARCH FLAT SMOOTH
AR48X6M	52	TRIM HALF ROUND ARCH DECORATIVE SMOOTH
AR60X6M	52	TRIM HALF ROUND ARCH DECORATIVE SMOOTH
AR64X10MC	52	TRIM HALF RND ARCH DECO W/END CAP SMOOTH
AR72X4F	51	TRIM HALF ROUND ARCH FLAT SMOOTH
AR72X6M	52	TRIM HALF ROUND ARCH DECORATIVE SMOOTH
<b>B</b>		
B3X4	183	FINIAL BALL SMOOTH
B3X5	183	FINIAL BALL SMOOTH
B4X6	183	FINIAL BALL SMOOTH
B5X7	183,250	NEWEL POST BALL SMOOTH
B6X8	183	FINIAL BALL SMOOTH
B6X9	183	FINIAL BALL SMOOTH
B7X9	183	FINIAL BALL SMOOTH
B8X10	183	FINIAL BALL SMOOTH
B10X13	183,250	NEWEL POST BALL SMOOTH
B12X16	183	FINIAL BALL SMOOTH
BAL2X20SQ	242	BALUSTER SQUARE SMOOTH
BAL2X24SQ	242	BALUSTER SQUARE SMOOTH

PART NUMBER	PAGE	DESCRIPTION
BAL2X28SQ	242	BALUSTER SQUARE SMOOTH
BAL2X32SQ	242	BALUSTER SQUARE SMOOTH
BAL2.5X15AY	237	BALUSTER ASHLEY SMOOTH
BAL3X18WF	241	BALUSTER WOODRUFF SMOOTH
BAL3X20AY	237	BALUSTER ASHLEY SMOOTH
BAL3X20CC	239	BALUSTER CLASSIC SMOOTH
BAL3X20WF	241	BALUSTER WOODRUFF SMOOTH
BAL3X24AY	237	BALUSTER ASHLEY SMOOTH
BAL3X24CC	239	BALUSTER CLASSIC SMOOTH
BAL3X24LN	240	BALUSTER LOGAN SMOOTH
BAL3X24WF	241	BALUSTER WOODRUFF SMOOTH
BAL3X28AY	237	BALUSTER ASHLEY SMOOTH
BAL3X28CC	239	BALUSTER CLASSIC SMOOTH
BAL3X28LN	240	BALUSTER LOGAN SMOOTH
BAL3X28WF	241	BALUSTER WOODRUFF SMOOTH
BAL3X32AY	237	BALUSTER ASHLEY SMOOTH
BAL3X32CC	239	BALUSTER CLASSIC SMOOTH
BAL3X32WF	241	BALUSTER WOODRUFF SMOOTH
BAL3X36AY	237	BALUSTER ASHLEY SMOOTH
BAL3X36WF	241	BALUSTER WOODRUFF SMOOTH
BAL4X22BE	238	BALUSTER BEAUMONT SMOOTH
BAL4X24AY	237	BALUSTER ASHLEY SMOOTH
BAL4X27CCOB	239	BALUSTER CLASSIC SMOOTH
BAL4X31CCOB	239	BALUSTER CLASSIC SMOOTH
BAL5X19BE	238	BALUSTER BEAUMONT SMOOTH
BAL5X20CC	239	BALUSTER CLASSIC SMOOTH
BAL5X20RL	240	BALUSTER ROSEDALE SMOOTH
BAL5X22BE	238	BALUSTER BEAUMONT SMOOTH
BAL5X24AY	237	BALUSTER ASHLEY SMOOTH
BAL5X24CC	239	BALUSTER CLASSIC SMOOTH
BAL5X24WF	241	BALUSTER WOODRUFF SMOOTH
BAL5X28CC	239	BALUSTER CLASSIC SMOOTH
BAL5X28CCOB	239	BALUSTER CLASSIC SMOOTH
BAL5X28EUST	256	BALUSTER, STONE TEXTURE, EUROSTYLE
BAL5X28WF	241	BALUSTER WOODRUFF SMOOTH
BAL5X30CC	239	BALUSTER CLASSIC SMOOTH
BAL5X31BE	238	BALUSTER BEAUMONT SMOOTH
BAL5X32AY	237	BALUSTER ASHLEY SMOOTH
BAL5X32CC	239	BALUSTER CLASSIC SMOOTH
BAL5X32WF	241	BALUSTER WOODRUFF SMOOTH
BAL6X22BE	238	BALUSTER BEAUMONT SMOOTH
BAL7X28CC	239	BALUSTER CLASSIC SMOOTH
BAL7X28CCOB	239	BALUSTER CLASSIC SMOOTH
BBR5X96	245	BALUSTER STRAIGHT BOTTOM RAIL SMOOTH
BBR5X144	245	BALUSTER STRAIGHT BOTTOM RAIL SMOOTH



PART NUMBER	PAGE	DESCRIPTION
<b>BBR6X96ST</b>	256	BALUSTER BOTTOM RAIL, STONE TEXTURE
<b>BBR7X96</b>	245	BALUSTER STRAIGHT BOTTOM RAIL SMOOTH
<b>BBR7X120</b>	245	BALUSTER STRAIGHT BOTTOM RAIL SMOOTH
<b>BBR7X144</b>	245	BALUSTER STRAIGHT BOTTOM RAIL SMOOTH
<b>BBR12X96</b>	245	BALUSTER STRAIGHT BOTTOM RAIL SMOOTH
<b>BBR12X120</b>	245	BALUSTER STRAIGHT BOTTOM RAIL SMOOTH
<b>BBR12X144</b>	245	BALUSTER STRAIGHT BOTTOM RAIL SMOOTH
<b>BC10X15</b>	123	BEAM CAP, TIMBER TEXTURE
<b>BKT4X18X4</b>	132	BRACKET SMOOTH
<b>BKT5X4</b>	136	BRACKET SMOOTH
<b>BKT5X5X9</b>	136	BRACKET SMOOTH
<b>BKT5X8X6</b>	132	BRACKET SMOOTH
<b>BKT5X10</b>	132	BRACKET SMOOTH
<b>BKT5X20</b>	131	BRACKET SMOOTH
<b>BKT6X8</b>	129	BRACKET SMOOTH
<b>BKT6X24</b>	131	BRACKET SMOOTH
<b>BKT6X24X6</b>	132	BRACKET SMOOTH
<b>BKT7X6X12</b>	136	BRACKET SMOOTH
<b>BKT7X11X3</b>	129	BRACKET SMOOTH
<b>BKT7X12X4</b>	130	BRACKET SMOOTH
<b>BKT7X16</b>	139	BRACKET SMOOTH
<b>BKT7X18</b>	139	BRACKET SMOOTH
<b>BKT8X6</b>	129	BRACKET SMOOTH
<b>BKT8X7X18</b>	136	BRACKET SMOOTH
<b>BKT8X8</b>	129	BRACKET SMOOTH
<b>BKT8X8X4</b>	129	BRACKET SMOOTH
<b>BKT8X9X14</b>	136	BRACKET SMOOTH
<b>BKT8X13</b>	130	BRACKET SMOOTH
<b>BKT8X15</b>	132	BRACKET SMOOTH
<b>BKT8X17</b>	139	BRACKET SMOOTH
<b>BKT8X29X4</b>	140	BRACKET SMOOTH
<b>BKT9X11</b>	124	BRACKET SMOOTH
<b>BKT9X13</b>	132	BRACKET SMOOTH
<b>BKT10X10X9</b>	129	BRACKET SMOOTH
<b>BKT10X11</b>	129	BRACKET SMOOTH
<b>BKT10X12</b>	135	BRACKET SMOOTH
<b>BKT10X12X4</b>	130	BRACKET SMOOTH
<b>BKT10X14</b>	139	BRACKET SMOOTH
<b>BKT10X16</b>	133	BRACKET SMOOTH
<b>BKT10X16X4</b>	124	BRACKET SMOOTH
<b>BKT11X12X3</b>	140	BRACKET SMOOTH
<b>BKT11X15</b>	132	BRACKET SMOOTH
<b>BKT11X16</b>	132	BRACKET SMOOTH
<b>BKT11X16X6</b>	139	BRACKET SMOOTH
<b>BKT11X17</b>	133	BRACKET SMOOTH

PART NUMBER	PAGE	DESCRIPTION
<b>BKT11X20</b>	124	BRACKET SMOOTH
<b>BKT11X20X6</b>	139	BRACKET SMOOTH
<b>BKT11X20X8</b>	138	BRACKET SMOOTH
<b>BKT11X30</b>	135	BRACKET SMOOTH
<b>BKT12X10</b>	130	BRACKET SMOOTH
<b>BKT12X12</b>	133	BRACKET SMOOTH
<b>BKT12X12X3</b>	135	BRACKET SMOOTH
<b>BKT12X12X4</b>	124	BRACKET SMOOTH
<b>BKT12X12GP</b>	133	BRACKET SMOOTH
<b>BKT12X12WW</b>	135	BRACKET SMOOTH
<b>BKT12X16</b>	124	BRACKET SMOOTH
<b>BKT12X17</b>	133	BRACKET SMOOTH
<b>BKT12X18X3X1S</b>	146	BRACKET, TIMBER TEXTURE
<b>BKT12X20X3S</b>	146	BRACKET, TIMBER TEXTURE
<b>BKT12X21X3</b>	135	BRACKET SMOOTH
<b>BKT12X24X3</b>	126	BRACKET SMOOTH
<b>BKT12X24X3S</b>	149	BRACKET, TIMBER TEXTURE
<b>BKT13X6</b>	136	BRACKET SMOOTH
<b>BKT13X13X3</b>	131	BRACKET SMOOTH
<b>BKT13X15</b>	140	BRACKET SMOOTH
<b>BKT13X18X8S</b>	148	BRACKET, TIMBER TEXTURE
<b>BKT14X30X7.5S</b>	148	BRACKET, TIMBER TEXTURE
<b>BKT14X14</b>	140	BRACKET SMOOTH
<b>BKT14X15</b>	135	BRACKET SMOOTH
<b>BKT14X16</b>	130	BRACKET SMOOTH
<b>BKT14X16X3.5S</b>	146	BRACKET, TIMBER TEXTURE
<b>BKT14X16X4</b>	124	BRACKET SMOOTH
<b>BKT14X16X6S</b>	146	BRACKET, TIMBER TEXTURE
<b>BKT14X26</b>	139	BRACKET SMOOTH
<b>BKT15X15</b>	140	BRACKET SMOOTH
<b>BKT15X18X6</b>	127	BRACKET SMOOTH
<b>BKT15X28</b>	133	BRACKET SMOOTH
<b>BKT16X9</b>	139	BRACKET SMOOTH
<b>BKT16X16</b>	124	BRACKET SMOOTH
<b>BKT16X18X3</b>	124	BRACKET SMOOTH
<b>BKT16X18X4S</b>	148	BRACKET, TIMBER TEXTURE
<b>BKT16X23X3</b>	135	BRACKET SMOOTH
<b>BKT16X32X4S</b>	148	BRACKET, TIMBER TEXTURE
<b>BKT17X17</b>	124	BRACKET SMOOTH
<b>BKT18X9X3</b>	130	BRACKET SMOOTH
<b>BKT18X10</b>	130	BRACKET SMOOTH
<b>BKT18X18X3X1S</b>	146	BRACKET, TIMBER TEXTURE
<b>BKT18X18X4</b>	124	BRACKET SMOOTH
<b>BKT18X24X3X2S</b>	146	BRACKET, TIMBER TEXTURE
<b>BKT18X24X3</b>	131	BRACKET SMOOTH

PART NUMBER	PAGE	DESCRIPTION
BKT18X24X4	126	BRACKET SMOOTH
BKT18X30X4	126	BRACKET SMOOTH
BKT18X35	138	BRACKET SMOOTH
BKT19X20	135	BRACKET SMOOTH
BKT19X24X4	127	BRACKET SMOOTH
BKT19X31	127	BRACKET SMOOTH
BKT19X36X4	127	BRACKET SMOOTH
BKT20X24X5	127	BRACKET SMOOTH
BKT20X30X6	126	BRACKET SMOOTH
BKT22X21	135	BRACKET SMOOTH
BKT22X22	140	BRACKET SMOOTH
BKT22X24X6S	146	BRACKET, TIMBER TEXTURE
BKT22X24X4S-1	146	BRACKET, TIMBER TEXTURE
BKT22X26	131	BRACKET SMOOTH
BKT22X30	133	BRACKET SMOOTH
BKT22X30X6S	149	BRACKET, TIMBER TEXTURE
BKT22X30X8S	148	BRACKET, TIMBER TEXTURE
BKT23X26	138	BRACKET SMOOTH
BKT24X12	139	BRACKET SMOOTH
BKT24X18X4S	146	BRACKET, TIMBER TEXTURE
BKT24X24X5	133	BRACKET SMOOTH
BKT24X24X12	130	BRACKET SMOOTH
BKT24X36	127	BRACKET SMOOTH
BKT25X25	127	BRACKET SMOOTH
BKT25X27	126	BRACKET SMOOTH
BKT26X24X6S	146	BRACKET, TIMBER TEXTURE
BKT26X28	140	BRACKET SMOOTH
BKT28X30	127	BRACKET SMOOTH
BKT30X30	127	BRACKET SMOOTH
BKT30X30X8	140	BRACKET SMOOTH
BKT31X30X5	127	BRACKET SMOOTH
BKT32X31X5	158	TRELLIS OUTLOOKER SMOOTH
BKT32X31X5S	158	BRACKET, TIMBER TEXTURE
BKT32X32	126	BRACKET SMOOTH
BKT36X36	127	BRACKET SMOOTH
BKT36X36X4	126	BRACKET SMOOTH
BKT36X36X6	126	BRACKET SMOOTH
BKT36X42	129	BRACKET SMOOTH
BKT40X40	126	BRACKET SMOOTH
BKTCV18X24X4S	149	BRACKET, TIMBER TEXTURE, COVE KNEE BRACE
BKTCV18X24X6S	149	BRACKET, TIMBER TEXTURE, COVE KNEE BRACE
BKTCV21X30X4S	149	BRACKET, TIMBER TEXTURE, COVE KNEE BRACE
BKTCV21X30X6S	149	BRACKET, TIMBER TEXTURE, COVE KNEE BRACE
BKTS18X24X6S	149	BRACKET, TIMBER TEXTURE, FLAT KNEE BRACE
BM4X5X192	163	BEAM SMOOTH
BMCDR8X6X168S	171	BEAM, TIMBER TEXTURE

PART NUMBER	PAGE	DESCRIPTION
BMCRT25X12X6S	157	BEAM, TIMBER TEXTURE, RAFTER TAIL
BMD4X8X48	158	TRELLIS BEAM SMOOTH
BMD4X8X48S	159	BEAM, TIMBER TEXTURE
BMD4X8X144	158	TRELLIS BEAM SMOOTH
BMD4X8X144S	159	BEAM, TIMBER TEXTURE
BEAM, BEAM MANTEL HAND HEWN		
BMH4X6X96ELM	166	BEAM HAND HEWN, ELM
BMH4X6X144ELM	166	BEAM HAND HEWN, ELM
BMH4X6X192ELM	166	BEAM HAND HEWN, ELM
BMH4X6X240ELM	166	BEAM HAND HEWN, ELM
BMH4X6X288ELM	166	BEAM HAND HEWN, ELM
BMH6X8X96ELM	166	BEAM HAND HEWN, ELM
BMH6X8X144ELM	166	BEAM HAND HEWN, ELM
BMH6X8X192ELM	166	BEAM HAND HEWN, ELM
BMH6X8X240ELM	166	BEAM HAND HEWN, ELM
BMH6X8X288ELM	166	BEAM HAND HEWN, ELM
BMH8X10X96ELM	166	BEAM HAND HEWN, ELM
BMH8X10X144ELM	166	BEAM HAND HEWN, ELM
BMH8X10X192ELM	166	BEAM HAND HEWN, ELM
BMH8X10X240ELM	166	BEAM HAND HEWN, ELM
BMH8X10X288ELM	166	BEAM HAND HEWN, ELM
BMH6X8X60ELM-EC	172	BEAM MANTEL HAND HEWN
BMH6X8X66ELM-EC	172	BEAM MANTEL HAND HEWN
BMH6X8X72ELM-EC	172	BEAM MANTEL HAND HEWN
BMH6X8X78ELM-EC	172	BEAM MANTEL HAND HEWN
BMH6X8X84ELM-EC	172	BEAM MANTEL HAND HEWN
BMH6X8X90ELM-EC	172	BEAM MANTEL HAND HEWN
BMH8X10X60ELM-EC	172	BEAM MANTEL HAND HEWN
BMH8X10X72ELM-EC	172	BEAM MANTEL HAND HEWN
BMH8X10X78ELM-EC	172	BEAM MANTEL HAND HEWN
BMH8X10X84ELM-EC	172	BEAM MANTEL HAND HEWN
BMH8X10X90ELM-EC	172	BEAM MANTEL HAND HEWN
BEAM MESA		
BMM4X6X96RDW	168	BEAM MESA, REDWOOD
BMM4X6X144RDW	168	BEAM MESA, REDWOOD
BMM4X6X192RDW	168	BEAM MESA, REDWOOD
BMM4X6X240RDW	168	BEAM MESA, REDWOOD
BMM4X6X288RDW	168	BEAM MESA, REDWOOD
BMM6X8X96RDW	168	BEAM MESA, REDWOOD
BMM6X8X144RDW	168	BEAM MESA, REDWOOD
BMM6X8X192RDW	168	BEAM MESA, REDWOOD
BMM6X8X240RDW	168	BEAM MESA, REDWOOD
BMM6X8X288RDW	168	BEAM MESA, REDWOOD
BMM8X10X96RDW	168	BEAM MESA, REDWOOD
BMM8X10X144RDW	168	BEAM MESA, REDWOOD

PART NUMBER	PAGE	DESCRIPTION
<b>BMM8X10X192RDW</b>	168	BEAM MESA, REDWOOD
<b>BMM8X10X240RDW</b>	168	BEAM MESA, REDWOOD
<b>BMM8X10X288RDW</b>	168	BEAM MESA, REDWOOD
<b>BMM10X15X234RDW</b>	168	BEAM MESA, REDWOOD
<b>BEAM MESA</b>		
<b>BMLPLTHDWKT10</b>	173	BEAM PLATE HARDWARE KIT, QTY 10
<b>BMLPLTHDWKT20</b>	173	BEAM PLATE HARDWARE KIT, QTY 20
<b>BMLPLTHDWKT40</b>	173	BEAM PLATE HARDWARE KIT, QTY 40
<b>BMPTH10X15</b>	173	BEAM PLATE HAMMERED
<b>BMPTH15X20</b>	173	BEAM PLATE HAMMERED
<b>BMPTH36X36</b>	173	BEAM PLATE HAMMERED
<b>BMPTH48X48</b>	173	BEAM PLATE HAMMERED
<b>BMPTH6X10</b>	173	BEAM PLATE HAMMERED
<b>BMPTH8X10</b>	173	BEAM PLATE HAMMERED
<b>BMPTS10X15</b>	173	BEAM PLATE SMOOTH
<b>BMPTS15X20</b>	173	BEAM PLATE SMOOTH
<b>BMPTS36X36</b>	173	BEAM PLATE SMOOTH
<b>BMPTS48X48</b>	173	BEAM PLATE SMOOTH
<b>BMPTS6X10</b>	173	BEAM PLATE SMOOTH
<b>BMPTS8X10</b>	173	BEAM PLATE SMOOTH
<b>BEAM, BEAM MANTEL ROUGH SAWN</b>		
<b>BMR4X6X96CDR</b>	164	BEAM ROUGH SAWN, WESTERN RED CEDAR
<b>BMR4X6X144CDR</b>	164	BEAM ROUGH SAWN, WESTERN RED CEDAR
<b>BMR4X6X192CDR</b>	164	BEAM ROUGH SAWN, WESTERN RED CEDAR
<b>BMR4X6X240CDR</b>	164	BEAM ROUGH SAWN, WESTERN RED CEDAR
<b>BMR4X6X288CDR</b>	164	BEAM ROUGH SAWN, WESTERN RED CEDAR
<b>BMR6X8X96CDR</b>	164	BEAM ROUGH SAWN, WESTERN RED CEDAR
<b>BMR6X8X144CDR</b>	164	BEAM ROUGH SAWN, WESTERN RED CEDAR
<b>BMR6X8X192CDR</b>	164	BEAM ROUGH SAWN, WESTERN RED CEDAR
<b>BMR6X8X240CDR</b>	164	BEAM ROUGH SAWN, WESTERN RED CEDAR
<b>BMR6X8X288CDR</b>	164	BEAM ROUGH SAWN, WESTERN RED CEDAR
<b>BMR8X10X96CDR</b>	164	BEAM ROUGH SAWN, WESTERN RED CEDAR
<b>BMR8X10X144CDR</b>	164	BEAM ROUGH SAWN, WESTERN RED CEDAR
<b>BMR8X10X192CDR</b>	164	BEAM ROUGH SAWN, WESTERN RED CEDAR
<b>BMR8X10X240CDR</b>	164	BEAM ROUGH SAWN, WESTERN RED CEDAR
<b>BMR8X10X288CDR</b>	164	BEAM ROUGH SAWN, WESTERN RED CEDAR
<b>BMR6X8X60CDR-EC</b>	172	BEAM MANTEL ROUGH SAWN
<b>BMR6X8X66CRR-EC</b>	172	BEAM MANTEL ROUGH SAWN
<b>BMR6X8X72CDR-EC</b>	172	BEAM MANTEL ROUGH SAWN
<b>BMR6X8X78CDR-EC</b>	172	BEAM MANTEL ROUGH SAWN
<b>BMR6X8X84CDR-EC</b>	172	BEAM MANTEL ROUGH SAWN
<b>BMR6X8X90CDR-EC</b>	172	BEAM MANTEL ROUGH SAWN
<b>BMR8X10X60CDR-EC</b>	172	BEAM MANTEL ROUGH SAWN
<b>BMR8X10X66CDR-EC</b>	172	BEAM MANTEL ROUGH SAWN
<b>BMR8X10X72CDR-EC</b>	172	BEAM MANTEL ROUGH SAWN
<b>BMR8X10X78CDR-EC</b>	172	BEAM MANTEL ROUGH SAWN

PART NUMBER	PAGE	DESCRIPTION
<b>BMR8X10X84CDR-EC</b>	172	BEAM MANTEL ROUGH SAWN
<b>BMR8X10X90CDR-EC</b>	172	BEAM MANTEL ROUGH SAWN
<b>BEAM RAFTER TAIL</b>		
<b>BMRT4X8X42S</b>	157	BEAM RAFTER TAIL, TIMBER TEXTURE
<b>BMRTBL4X6X12RS-4PK</b>	156	BEAM RAFTER TAIL, ROUGH SAWN, BULLNOSE
<b>BMRTBL4X6X12RSP4-4PK</b>	156	BEAM RAFTER TAIL, ROUGH SAWN, BULLNOSE
<b>BMRTBL4X6X12RSP6-4PK</b>	156	BEAM RAFTER TAIL, ROUGH SAWN, BULLNOSE
<b>BMRTBL4X6X12RSP8-4PK</b>	156	BEAM RAFTER TAIL, ROUGH SAWN, BULLNOSE
<b>BMRTBL4X6X12RSP10-4PK</b>	156	BEAM RAFTER TAIL, ROUGH SAWN, BULLNOSE
<b>BMRTBL4X6X12RSP12-4PK</b>	156	BEAM RAFTER TAIL, ROUGH SAWN, BULLNOSE
<b>BMRTBL4X6X12RS-10PK</b>	156	BEAM RAFTER TAIL, ROUGH SAWN, BULLNOSE
<b>BMRTBL4X6X12RSP4-10PK</b>	156	BEAM RAFTER TAIL, ROUGH SAWN, BULLNOSE
<b>BMRTBL4X6X12RSP6-10PK</b>	156	BEAM RAFTER TAIL, ROUGH SAWN, BULLNOSE
<b>BMRTBL4X6X12RSP8-10PK</b>	156	BEAM RAFTER TAIL, ROUGH SAWN, BULLNOSE
<b>BMRTBL4X6X12RSP10-10PK</b>	156	BEAM RAFTER TAIL, ROUGH SAWN, BULLNOSE
<b>BMRTBL4X6X12RSP12-10PK</b>	156	BEAM RAFTER TAIL, ROUGH SAWN, BULLNOSE
<b>BMRTBL4X6X18RS-4PK</b>	156	BEAM RAFTER TAIL, ROUGH SAWN, BULLNOSE
<b>BMRTBL4X6X18RSP4-4PK</b>	156	BEAM RAFTER TAIL, ROUGH SAWN, BULLNOSE
<b>BMRTBL4X6X18RSP6-4PK</b>	156	BEAM RAFTER TAIL, ROUGH SAWN, BULLNOSE
<b>BMRTBL4X6X18RSP8-4PK</b>	156	BEAM RAFTER TAIL, ROUGH SAWN, BULLNOSE
<b>BMRTBL4X6X18RSP10-4PK</b>	156	BEAM RAFTER TAIL, ROUGH SAWN, BULLNOSE
<b>BMRTBL4X6X18RSP12-4PK</b>	156	BEAM RAFTER TAIL, ROUGH SAWN, BULLNOSE
<b>BMRTBL4X6X18RS-10PK</b>	156	BEAM RAFTER TAIL, ROUGH SAWN, BULLNOSE
<b>BMRTBL4X6X18RSP4-10PK</b>	156	BEAM RAFTER TAIL, ROUGH SAWN, BULLNOSE
<b>BMRTBL4X6X18RSP6-10PK</b>	156	BEAM RAFTER TAIL, ROUGH SAWN, BULLNOSE
<b>BMRTBL4X6X18RSP8-10PK</b>	156	BEAM RAFTER TAIL, ROUGH SAWN, BULLNOSE
<b>BMRTBL4X6X18RSP10-10PK</b>	156	BEAM RAFTER TAIL, ROUGH SAWN, BULLNOSE
<b>BMRTBL4X6X18RSP12-10PK</b>	156	BEAM RAFTER TAIL, ROUGH SAWN, BULLNOSE
<b>BMRTBL4X6X24RS-4PK</b>	156	BEAM RAFTER TAIL, ROUGH SAWN, BULLNOSE
<b>BMRTBL4X6X24RSP4-4PK</b>	156	BEAM RAFTER TAIL, ROUGH SAWN, BULLNOSE
<b>BMRTBL4X6X24RSP6-4PK</b>	156	BEAM RAFTER TAIL, ROUGH SAWN, BULLNOSE
<b>BMRTBL4X6X24RSP8-4PK</b>	156	BEAM RAFTER TAIL, ROUGH SAWN, BULLNOSE
<b>BMRTBL4X6X24RSP10-4PK</b>	156	BEAM RAFTER TAIL, ROUGH SAWN, BULLNOSE
<b>BMRTBL4X6X24RSP12-4PK</b>	156	BEAM RAFTER TAIL, ROUGH SAWN, BULLNOSE
<b>BMRTBL4X6X24RS-10PK</b>	156	BEAM RAFTER TAIL, ROUGH SAWN, BULLNOSE
<b>BMRTBL4X6X24RSP4-10PK</b>	156	BEAM RAFTER TAIL, ROUGH SAWN, BULLNOSE
<b>BMRTBL4X6X24RSP6-10PK</b>	156	BEAM RAFTER TAIL, ROUGH SAWN, BULLNOSE
<b>BMRTBL4X6X24RSP8-10PK</b>	156	BEAM RAFTER TAIL, ROUGH SAWN, BULLNOSE
<b>BMRTBL4X6X24RSP10-10PK</b>	156	BEAM RAFTER TAIL, ROUGH SAWN, BULLNOSE
<b>BMRTBL4X6X24RSP12-10PK</b>	156	BEAM RAFTER TAIL, ROUGH SAWN, BULLNOSE
<b>BMRTBL4X6X30RS-4PK</b>	156	BEAM RAFTER TAIL, ROUGH SAWN, BULLNOSE
<b>BMRTBL4X6X30RSP4-4PK</b>	156	BEAM RAFTER TAIL, ROUGH SAWN, BULLNOSE
<b>BMRTBL4X6X30RSP6-4PK</b>	156	BEAM RAFTER TAIL, ROUGH SAWN, BULLNOSE
<b>BMRTBL4X6X30RSP8-4PK</b>	156	BEAM RAFTER TAIL, ROUGH SAWN, BULLNOSE
<b>BMRTBL4X6X30RSP10-4PK</b>	156	BEAM RAFTER TAIL, ROUGH SAWN, BULLNOSE
<b>BMRTBL4X6X30RSP12-4PK</b>	156	BEAM RAFTER TAIL, ROUGH SAWN, BULLNOSE













PART NUMBER	PAGE	DESCRIPTION
BMSMT4X6X216	160	BEAM SMOOTH
BMSMT4X6X240	160	BEAM SMOOTH
BMSMT6X8X96	160	BEAM SMOOTH
BMSMT6X8X120	160	BEAM SMOOTH
BMSMT6X8X144	160	BEAM SMOOTH
BMSMT6X8X168	160	BEAM SMOOTH
BMSMT6X8X192	160	BEAM SMOOTH
BMSMT6X8X216	160	BEAM SMOOTH
BMSMT6X8X240	160	BEAM SMOOTH
BMSMT8X10X96	160	BEAM SMOOTH
BMSMT8X10X120	160	BEAM SMOOTH
BMSMT8X10X144	160	BEAM SMOOTH
BMSMT8X10X168	160	BEAM SMOOTH
BMSMT8X10X192	160	BEAM SMOOTH
BMSMT8X10X216	160	BEAM SMOOTH
BMSMT8X10X240	160	BEAM SMOOTH
BMSTRPH10X15	173	BEAM STRAP HAMMERED
BMSTRPH4X6	173	BEAM STRAP HAMMERED
BMSTRPH6X8	173	BEAM STRAP HAMMERED
BMSTRPH8X10	173	BEAM STRAP HAMMERED
BMSTRPS10X15	173	BEAM STRAP SMOOTH
BMSTRPS4X6	173	BEAM STRAP SMOOTH
BMSTRPS6X8	173	BEAM STRAP SMOOTH
BMSTRPS8X10	173	BEAM STRAP SMOOTH
<b>BEAM TAHOE</b>		
BMT4X6X96CDR	170	BEAM TAHOE, WESTERN RED CEDAR
BMT4X6X144CDR	170	BEAM TAHOE, WESTERN RED CEDAR
BMT4X6X192CDR	170	BEAM TAHOE, WESTERN RED CEDAR
BMT4X6X240CDR	170	BEAM TAHOE, WESTERN RED CEDAR
BMT4X6X288CDR	170	BEAM TAHOE, WESTERN RED CEDAR
BMT6X8X96CDR	170	BEAM TAHOE, WESTERN RED CEDAR
BMT6X8X144CDR	170	BEAM TAHOE, WESTERN RED CEDAR
BMT6X8X192CDR	170	BEAM TAHOE, WESTERN RED CEDAR
BMT6X8X240CDR	170	BEAM TAHOE, WESTERN RED CEDAR
BMT6X8X288CDR	170	BEAM TAHOE, WESTERN RED CEDAR
BMT8X10X96CDR	170	BEAM TAHOE, WESTERN RED CEDAR
BMT8X10X144CDR	170	BEAM TAHOE, WESTERN RED CEDAR
BMT8X10X192CDR	170	BEAM TAHOE, WESTERN RED CEDAR
BMT8X10X240CDR	170	BEAM TAHOE, WESTERN RED CEDAR
BMT8X10X288CDR	170	BEAM TAHOE, WESTERN RED CEDAR
BTM6X144	173	BEAM TOP MESA
BTM8X144	173	BEAM TOP MESA
BRK5	246	BALUSTER RAIL INSTALL KIT
BRK6-7	246	BALUSTER RAIL INSTALL KIT
BRK12	246	BALUSTER RAIL INSTALL KIT
BRK12ANGLBKT	246	BALUSTER RAIL INSTALL KIT

PART NUMBER	PAGE	DESCRIPTION
BTR5X96	244	BALUSTER STRAIGHT TOP RAIL SMOOTH
BTR5X144	244	BALUSTER STRAIGHT TOP RAIL SMOOTH
BTR6X96ST	256	BALUSTER TOP RAIL, STONE TEXTURE
BTR7X96	244	BALUSTER STRAIGHT TOP RAIL SMOOTH
BTR7X120	244	BALUSTER STRAIGHT TOP RAIL SMOOTH
BTR7X144	244	BALUSTER STRAIGHT TOP RAIL SMOOTH
BTR12X96	245	BALUSTER STRAIGHT TOP RAIL SMOOTH
BTR12X120	245	BALUSTER STRAIGHT TOP RAIL SMOOTH
BTR12X144	245	BALUSTER STRAIGHT TOP RAIL SMOOTH
<b>C</b>		
CAP47E	42	PEDIMENT COMBO ECO ACORN SMOOTH
CAP50	42	PEDIMENT COMBO ACORN SMOOTH
CAP50BT	42	PEDIMENT COMBO ACORN W/BT SMOOTH
CAP54	42	PEDIMENT COMBO ACORN SMOOTH
CAP54BT	42	PEDIMENT COMBO ACORN W/BT SMOOTH
CAP58	42	PEDIMENT COMBO ACORN SMOOTH
CAP58BT	42	PEDIMENT COMBO ACORN W/BT SMOOTH
CAP67	42	PEDIMENT COMBO ACORN SMOOTH
CAP67BT	42	PEDIMENT COMBO ACORN W/BT SMOOTH
CAP75	42	PEDIMENT COMBO ACORN SMOOTH
CAP75BT	42	PEDIMENT COMBO ACORN W/BT SMOOTH
CAP80	42	PEDIMENT COMBO ACORN SMOOTH
CAP80BT	42	PEDIMENT COMBO ACORN W/BT SMOOTH
CAP85	42	PEDIMENT COMBO ACORN SMOOTH
CAP85BT	42	PEDIMENT COMBO ACORN W/BT SMOOTH
<b>10" CROSSHEAD</b>		
CCA32X10	32	CROSSHEAD SMOOTH
CCA32X10D	32	CROSSHEAD W/DT SMOOTH
CCA32X10K	32	CROSSHEAD W/KEY SMOOTH
CCA32X10T	32	CROSSHEAD W/TS SMOOTH
CCA32X11BT	32	CROSSHEAD W/BT SMOOTH
CCA34X10	32	CROSSHEAD SMOOTH
CCA34X10D	32	CROSSHEAD W/DT SMOOTH
CCA34X10K	32	CROSSHEAD W/KEY SMOOTH
CCA34X10T	32	CROSSHEAD W/TS SMOOTH
CCA34X11BT	32	CROSSHEAD W/BT SMOOTH
CCA36X10	32	CROSSHEAD SMOOTH
CCA36X10D	32	CROSSHEAD W/DT SMOOTH
CCA36X10K	32	CROSSHEAD SMOOTH
CCA36X10T	32	CROSSHEAD W/TS SMOOTH
CCA36X11BT	32	CROSSHEAD W/BT SMOOTH
CCA40X10	32	CROSSHEAD SMOOTH
CCA40X10D	32	CROSSHEAD W/DT SMOOTH
CCA40X10K	32	CROSSHEAD W/KEY SMOOTH
CCA40X10T	32	CROSSHEAD W/TS SMOOTH
CCA40X11BT	32	CROSSHEAD W/BT SMOOTH

PART NUMBER	PAGE	DESCRIPTION
CCA47X10	32	CROSSHEAD SMOOTH
CCA47X10D	32	CROSSHEAD W/DT SMOOTH
CCA47X10K	32	CROSSHEAD W/KEY SMOOTH
CCA47X10T	32	CROSSHEAD W/TS SMOOTH
CCA47X11BT	32	CROSSHEAD W/BT SMOOTH
CCA52X10	32	CROSSHEAD SMOOTH
CCA52X10D	32	CROSSHEAD W/DT SMOOTH
CCA52X10K	32	CROSSHEAD W/KEY SMOOTH
CCA52X10T	32	CROSSHEAD W/TS SMOOTH
CCA52X11BT	32	CROSSHEAD W/BT SMOOTH
CCA64X10	32	CROSSHEAD SMOOTH
CCA64X10D	32	CROSSHEAD W/DT SMOOTH
CCA64X10K	32	CROSSHEAD W/KEY SMOOTH
CCA64X10T	32	CROSSHEAD W/TS SMOOTH
CCA64X11BT	32	CROSSHEAD W/BT SMOOTH
CCA72X10	32	CROSSHEAD SMOOTH
CCA72X10D	32	CROSSHEAD W/DT SMOOTH
CCA72X10K	32	CROSSHEAD SMOOTH
CCA72X10T	32	CROSSHEAD W/TS SMOOTH
CCA72X11BT	32	CROSSHEAD W/BT SMOOTH
CCA100X10	32	CROSSHEAD SMOOTH
CCA100X10D	32	CROSSHEAD W/DT SMOOTH
CCA100X10K	32	CROSSHEAD W/KEY SMOOTH
CCA100X10T	32	CROSSHEAD W/TS SMOOTH
CCA100X11BT	32	CROSSHEAD W/BT SMOOTH
CCA106X10	32	CROSSHEAD SMOOTH
CCA106X10D	32	CROSSHEAD W/DT SMOOTH
CCA106X10K	32	CROSSHEAD W/KEY SMOOTH
CCA106X10T	32	CROSSHEAD W/TS SMOOTH
CCA106X11BT	32	CROSSHEAD W/BT SMOOTH
CCA199X10	32	CROSSHEAD SMOOTH
CCA199X10D	32	CROSSHEAD W/DT SMOOTH
CCA199X10K	32	CROSSHEAD W/KEY SMOOTH
CCA199X10T	32	CROSSHEAD W/TS SMOOTH
CCA199X11BT	32	CROSSHEAD W/BT SMOOTH
CCA200X10	32	CROSSHEAD SMOOTH
CCA200X10D	32	CROSSHEAD W/DT SMOOTH
CCA200X10K	32	CROSSHEAD W/KEY SMOOTH
CCA200X10T	32	CROSSHEAD W/TS SMOOTH
CCA200X11BT	32	CROSSHEAD W/BT SMOOTH
CCP37	41	PEDIMENT COMBO PEAKED CAP SMOOTH
CCP37BT	41	PEDIMENT COMBO PEAKED W/BT SMOOTH
DISTINCTION 6" READY-TO-INSTALL		
CH2_X6EC	19	DISTINCTION 6" READY-TO-INSTALL WITH END CAPS
DISTINCTION 6" READY-TO-INSTALL BOTTOM TRIM		
CH_X7ECBT	19	DISTINCTION 6" READY-TO-INSTALL WITH END CAPS & BOTTOM TRIM

PART NUMBER	PAGE	DESCRIPTION
DISTINCTION 6" READY-TO-INSTALL DENTIL TRIM		
CH_X6ECD	19	DISTINCTION 6" READY-TO-INSTALL WITH END CAPS & DENTIL TRIM
DISTINCTION 6" READY-TO-INSTALL WITH KEystone		
CH_X6ECK	19	DISTINCTION 6" READY-TO-INSTALL WITH END CAPS & KEystone
DISTINCTION 9" READY-TO-INSTALL		
CH_X9EC	19	DISTINCTION 9" READY-TO-INSTALL WITH END CAPS
DISTINCTION 9" READY-TO-INSTALL WITH DENTIL TRIM		
CH_X9ECD	19	DISTINCTION 9" READY-TO-INSTALL WITH END CAPS & BOTTOM TRIM
DISTINCTION 9" READY-TO-INSTALL BOTTOM TRIM		
CH_X10ECBT	19	DISTINCTION 9" READY-TO-INSTALL WITH END CAPS & DENTIL TRIM
DISTINCTION 9" READY-TO-INSTALL WITH KEystone		
CH_X9ECK	19	DISTINCTION 9" READY-TO-INSTALL WITH END CAPS & KEystone
DISTINCTION 6" READY-TO-INSTALL CROSSHEAD FOR 5" PILASTER		
CH_X6EC5	19	DISTINCTION 6" READY-TO-INSTALL WITH END CAPS 5" PILASTER
DISTINCTION 9" READY-TO-INSTALL CROSSHEAD FOR 5" PILASTER		
CH_X9EC5	19	DISTINCTION 9" READY-TO-INSTALL WITH END CAPS 5" PILASTER
DISTINCTION 6" READY-TO-INSTALL CROSSHEAD FOR 7" PILASTER		
CH_X6EC7	19	DISTINCTION 6" READY-TO-INSTALL WITH END CAPS 7" PILASTER
DISTINCTION 9" READY-TO-INSTALL CROSSHEAD FOR 7" PILASTER		
CH_X9EC7	19	DISTINCTION 9" READY-TO-INSTALL WITH END CAPS 7" PILASTER
DISTINCTION 6" READY-TO-INSTALL CROSSHEAD FOR 9" PILASTER		
CH51X6EC9	19	DISTINCTION 6" READY-TO-INSTALL WITH END CAPS 9" PILASTER
DISTINCTION 9" READY-TO-INSTALL CROSSHEAD FOR 9" PILASTER		
CH51X9EC9	19	DISTINCTION 9" READY-TO-INSTALL WITH END CAPS 9" PILASTER
DISTINCTION END CAPS		
CHC2X6	20	DISTINCTION CROSSHEAD END CAP
CHC2X6-5	20	DISTINCTION CROSSHEAD END CAP
CHC2X9	20	DISTINCTION CROSSHEAD END CAP
CHC2X9-5	20	DISTINCTION CROSSHEAD END CAP
CHC4X6	20	DISTINCTION CROSSHEAD END CAP
CHC4X6-5	20	DISTINCTION CROSSHEAD END CAP
CHC4X9	20	DISTINCTION CROSSHEAD END CAP
CHC4X9-5	20	DISTINCTION CROSSHEAD END CAP
CHC7X6	20	DISTINCTION CROSSHEAD END CAP
CHC7X6-5	20	DISTINCTION CROSSHEAD END CAP
CHC7X9	20	DISTINCTION CROSSHEAD END CAP
CHC7X9-5	20	DISTINCTION CROSSHEAD END CAP
CHC11X6	20	DISTINCTION CROSSHEAD END CAP
CHC11X6-5	20	DISTINCTION CROSSHEAD END CAP
CHC11X9	20	DISTINCTION CROSSHEAD END CAP
CHC11X9-5	20	DISTINCTION CROSSHEAD END CAP
CRAFTSMAN COVE READY-TO-INSTALL		
CHCC_X9BTEC	23	CRAFTSMAN COVE CROSSHEAD READY-TO-INSTALL
CRAFTSMAN COVE END CAPS		
CHCCC4X9BT	25	CRAFTSMAN COVE CROSSHEAD END CAPS
CHCCC4X9BT-5	25	CRAFTSMAN COVE CROSSHEAD END CAPS

PART NUMBER	PAGE	DESCRIPTION
CHCC6X9BT	25	CRAFTSMAN COVE CROSSHEAD END CAPS
CHCC6X9BT-5	25	CRAFTSMAN COVE CROSSHEAD END CAPS
CRAFTSMAN COVE TRIMMABLE		
CHCCT36X9BT	25	TRIMMABLE CRAFTSMAN COVE CROSSHEAD
CHCCT48X9BT	25	TRIMMABLE CRAFTSMAN COVE CROSSHEAD
CHCCT144X9BT	25	TRIMMABLE CRAFTSMAN COVE CROSSHEAD
CHCCT216X9BT	25	TRIMMABLE CRAFTSMAN COVE CROSSHEAD
CRAFTSMAN STEP 6" TRIMMABLE		
CHCST36X6	27	CRAFTSMAN STEP CROSSHEAD
CHCST48X6	27	CRAFTSMAN STEP CROSSHEAD
CHCST144X6	27	CRAFTSMAN STEP CROSSHEAD
CHCST216X6	27	CRAFTSMAN STEP CROSSHEAD
CRAFTSMAN STEP 8" TRIMMABLE		
CHCST36X8	27	CRAFTSMAN STEP CROSSHEAD
CHCST48X8	27	CRAFTSMAN STEP CROSSHEAD
CHCST144X8	27	CRAFTSMAN STEP CROSSHEAD
CHCST216X8	27	CRAFTSMAN STEP CROSSHEAD
DISTINCTION 6" TRIMMABLE		
CHT36X6	20	TRIMMABLE CROSSHEAD
CHT48X6	20	TRIMMABLE CROSSHEAD
CHT144X6	20	TRIMMABLE CROSSHEAD
CHT216X6	20	TRIMMABLE CROSSHEAD
DISTINCTION 9" TRIMMABLE		
CHT36X9	20	TRIMMABLE CROSSHEAD
CHT48X9	20	TRIMMABLE CROSSHEAD
CHT144X9	20	TRIMMABLE CROSSHEAD
CHT216X9	20	TRIMMABLE CROSSHEAD
CIR24X4F	53	TRIM CIRCLE SMOOTH
CIR36X4F	53	TRIM CIRCLE SMOOTH
CLV12X24	188	CATHEDRAL LOUVER DECO SMOOTH
CLV14X22	188	CATHEDRAL LOUVER DECO SMOOTH
CLV16X36	188	CATHEDRAL LOUVER DECO SMOOTH
CLV18X24	188	CATHEDRAL LOUVER DECO SMOOTH
CLV18X30	188	CATHEDRAL LOUVER DECO SMOOTH
CLV18X30X4F	188	TRIM CATHEDRAL LOUVER SMOOTH
CLV18X54	188	CATHEDRAL LOUVER DECO SMOOTH
CLV22X31	188	CATHEDRAL LOUVER DECO SMOOTH
CLV22X31X4F	188	TRIM CATHEDRAL LOUVER SMOOTH
CLV24X48	188	CATHEDRAL LOUVER DECO SMOOTH
CLV28X43	188	CATHEDRAL LOUVER DECO SMOOTH
CLV36X48	188	CATHEDRAL LOUVER DECO SMOOTH
CM15BM	177	CEILING MEDALLION 1PC BEAUMONT SMOOTH
CM16FL	177	CEILING MEDALLION 1PC FLORENTINE SMOOTH
CM16FL2	177	CEILING MEDALLION 2PC FLOR SMOOTH
CM16JE2	177	CEILING MEDALLION 2PC JEFFERSON SMOOTH
CM24RN	177	CEILING MEDALLION 1PC RANDOLPH SMOOTH

PART NUMBER	PAGE	DESCRIPTION
CM36NI	177	CEILING MEDALLION 1PC NICHOLAS SMOOTH
CM67WT	177	CEILING MEDALLION 1PC WHITNEY SMOOTH
CN6X6	180	COVER VENT
COL11X108PSQ	252	COLUMN SQUARE PLAIN SMOOTH
COL11X96PSQ	252	COLUMN SQUARE PLAIN SMOOTH
COL8X96PSQ	252	COLUMN SQUARE PLAIN SMOOTH
COR5X5S	150	CORBEL, TIMBER TEXTURE
COR5X5X3S	150	CORBEL, TIMBER TEXTURE
COR7X11S	152	CORBEL, TIMBER TEXTURE
COR7X13X7S	150	CORBEL, TIMBER TEXTURE
COR7X15X4S	154	CORBEL, TIMBER TEXTURE
COR8X8X6S	150	CORBEL, TIMBER TEXTURE
COR11X11X5S	150	CORBEL, TIMBER TEXTURE
COR11X13X6S	153	CORBEL, TIMBER TEXTURE
COR12X18X6S	154	CORBEL, TIMBER TEXTURE
COR14X12X6S	153	CORBEL, TIMBER TEXTURE
COR16X10X8S	153	CORBEL, TIMBER TEXTURE
COR16X7X3S	153	CORBEL, TIMBER TEXTURE
COR16X8S	154	CORBEL, TIMBER TEXTURE
COR18X8X6S	154	CORBEL, TIMBER TEXTURE
COR18X9X3S	154	CORBEL, TIMBER TEXTURE
COR24X5X5S	154	CORBEL, TIMBER TEXTURE
COR24X8X4S	154	CORBEL, TIMBER TEXTURE
COR24X8X6S	150	CORBEL, TIMBER TEXTURE
COR39X10X5.5S	153	CORBEL, TIMBER TEXTURE
CORCV18X6X6S	150	CORBEL, TIMBER TEXTURE, COVE
CORCV18X8X4S	150	CORBEL, TIMBER TEXTURE, COVE
CORCV18X8X6S	150	CORBEL, TIMBER TEXTURE, COVE
CORCV18X12X6S	150	CORBEL, TIMBER TEXTURE, COVE
COROG8X12S	152	CORBEL, TIMBER TEXTURE, OGEE
COROG15X7S	152	CORBEL, TIMBER TEXTURE
COROG20X7S	152	CORBEL, TIMBER TEXTURE, OGEE
COROG24X6S	152	CORBEL, TIMBER TEXTURE, OGEE
COROGA15X7S	152	CORBEL, TIMBER TEXTURE
COROGD15X7S	152	CORBEL, TIMBER TEXTURE
CPCP48	40	PEDIMENT COMBO PEAKED CAP SMOOTH
CPCP48BT	40	PEDIMENT COMBO PEAKED W/BT SMOOTH
CPCP50	40	PEDIMENT COMBO PEAKED CAP SMOOTH
CPCP50BT	40	PEDIMENT COMBO PEAKED CAP W/BT SMOOTH
CPCP54	40	PEDIMENT COMBO PEAKED CAP SMOOTH
CPCP54BT	40	PEDIMENT COMBO PEAKED W/BT SMOOTH
CPCP58	40	PEDIMENT COMBO PEAKED CAP SMOOTH
CPCP58BT	40	PEDIMENT COMBO PEAKED CAP W/BT SMOOTH
CPCP67	40	PEDIMENT COMBO PEAKED CAP SMOOTH
CPCP67BT	40	PEDIMENT COMBO PEAKED CAP W/BT SMOOTH
CPCP75	40	PEDIMENT COMBO PEAKED CAP SMOOTH

PART NUMBER	PAGE	DESCRIPTION
CPCP75BT	40	PEDIMENT COMBO PEAKED CAP W/BT SMOOTH
CPCP80	40	PEDIMENT COMBO PEAKED CAP SMOOTH
CPCP80BT	40	PEDIMENT COMBO PEAKED W/BT SMOOTH
CPCP85	40	PEDIMENT COMBO PEAKED CAP SMOOTH
CPCP85BT	40	PEDIMENT COMBO PEAKED CAP W/BT SMOOTH
CRHP54	43	PEDIMENT COMBO RAMS HEAD SMOOTH
CRHP54BT	43	PEDIMENT COMBO RAMS HEAD W/BT SMOOTH
CRHP67	43	PEDIMENT COMBO RAMS HEAD SMOOTH
CRHP67BT	43	PEDIMENT COMBO RAMS HEAD W/BT SMOOTH
CRHP75	43	PEDIMENT COMBO RAMS HEAD SMOOTH
CRHP75BT	43	PEDIMENT COMBO RAMS HEAD W/BT SMOOTH
CRHP80	43	PEDIMENT COMBO RAMS HEAD SMOOTH
CRHP80BT	43	PEDIMENT COMBO RAMS HEAD W/BT SMOOTH
CRHP85	43	PEDIMENT COMBO RAMS HEAD SMOOTH
CRHP85BT	43	PEDIMENT COMBO RAMS HEAD W/BT SMOOTH
CSAP36	39	PEDIMENT COMBO SGMT ARCH SMOOTH
CSAP36BT	39	PEDIMENT COMBO SGMT ARCH W/BT SMOOTH
CSAP48	39	PEDIMENT COMBO SGMT ARCH SMOOTH
CSAP48BT	39	PEDIMENT COMBO SGMT ARCH W/BT SMOOTH
CSAP65	39	PEDIMENT COMBO SGMT ARCH SMOOTH
CSAP65BT	39	PEDIMENT COMBO SGMT ARCH W/BT SMOOTH
CSAP84	39	PEDIMENT COMBO SGMT ARCH SMOOTH
CSAP84BT	39	PEDIMENT COMBO SGMT ARCH W/BT SMOOTH
CSP54	39	PEDIMENT COMBO SUNBURST SMOOTH
CSP54BT	39	PEDIMENT COMBO SUNBURST W/BT SMOOTH
CSP75	39	PEDIMENT COMBO SUNBURST SMOOTH
CSP75BT	39	PEDIMENT COMBO SUNBURST W/BT SMOOTH
CSP80	39	PEDIMENT COMBO SUNBURST SMOOTH
CSP80BT	39	PEDIMENT COMBO SUNBURST W/BT SMOOTH
CSP85	39	PEDIMENT COMBO SUNBURST SMOOTH
CSP85BT	39	PEDIMENT COMBO SUNBURST W/BT SMOOTH
COLUMN WRAP ACCESSORIES		
CW6NM	215	COLUMN WRAP CAP BASE NECK MOULD
CW8NM	215	COLUMN WRAP CAP BASE NECK MOULD
CW10NM	215	COLUMN WRAP CAP BASE NECK MOULD
CW12NM	215	COLUMN WRAP CAP BASE NECK MOULD
CW17NM	215	COLUMN WRAP CAP BASE NECK MOULD
CWCB6CF	215	COLUMN WRAP CAP BASE CRAFTSMAN
CWCB8CF	215	COLUMN WRAP CAP BASE CRAFTSMAN
CWCB10CF	215	COLUMN WRAP CAP BASE CRAFTSMAN
CWCB12CF	215	COLUMN WRAP CAP BASE CRAFTSMAN
CWCB8X12CF	219	COLUMN WRAP CAP BASE CRAFTSMAN
CWCB11X16CF	219	COLUMN WRAP CAP BASE CRAFTSMAN
CWCB13X20CF	219	COLUMN WRAP CAP BASE CRAFTSMAN
CWCB16X24CF	219	COLUMN WRAP CAP BASE CRAFTSMAN
CWCB6EV	207	COLUMN WRAP CAP BASE EVERCEDAR

PART NUMBER	PAGE	DESCRIPTION
CWCB8EV	207	COLUMN WRAP CAP BASE EVERCEDAR
CWCB10EV	207	COLUMN WRAP CAP BASE EVERCEDAR
CWCB12EV	207	COLUMN WRAP CAP BASE EVERCEDAR
CWCB8X12EV48-60	208	COLUMN WRAP CAP BASE EVERCEDAR
CWCB8X12EV66-96	208	COLUMN WRAP CAP BASE EVERCEDAR
CWCB11X16EV48-60	208	COLUMN WRAP CAP BASE EVERCEDAR
CWCB11X16EV66-96	208	COLUMN WRAP CAP BASE EVERCEDAR
CWCB6GK	215	COLUMN WRAP CAP BASE GREEK
CWCB8GK	215	COLUMN WRAP CAP BASE GREEK
CWCB10GK	215	COLUMN WRAP CAP BASE GREEK
CWCB12GK	215	COLUMN WRAP CAP BASE GREEK
CWCB8X12GK	219	COLUMN WRAP CAP BASE GREEK
CWCB11X16GK	219	COLUMN WRAP CAP BASE GREEK
CWCB13X20GK	219	COLUMN WRAP CAP BASE GREEK
CWCB16X24GK	219	COLUMN WRAP CAP BASE GREEK
CWCB6PL	215	COLUMN WRAP CAP BASE PLAIN
CWCB8PL	215	COLUMN WRAP CAP BASE PLAIN
CWCB10PL	215	COLUMN WRAP CAP BASE PLAIN
CWCB12PL	215	COLUMN WRAP CAP BASE PLAIN
CWCB6RO	215	COLUMN WRAP CAP BASE ROMAN
CWCB8RO	215	COLUMN WRAP CAP BASE ROMAN
CWCB10RO	215	COLUMN WRAP CAP BASE ROMAN
CWCB12RO	215	COLUMN WRAP CAP BASE ROMAN
CWCB8X12RO	219	COLUMN WRAP CAP BASE ROMAN
CWCB11X16RO	219	COLUMN WRAP CAP BASE ROMAN
CWCB13X20RO	219	COLUMN WRAP CAP BASE ROMAN
CWCB16X24RO	219	COLUMN WRAP CAP BASE ROMAN
CWCB6TR	215	COLUMN WRAP CAP BASE TRADITIONAL
CWCB8TR	215	COLUMN WRAP CAP BASE TRADITIONAL
CWCB10TR	215	COLUMN WRAP CAP BASE TRADITIONAL
CWCB12TR	215	COLUMN WRAP CAP BASE TRADITIONAL
CWCB6TS	215	COLUMN WRAP CAP BASE TUSCAN
CWCB8TS	215	COLUMN WRAP CAP BASE TUSCAN
CWCB10TS	215	COLUMN WRAP CAP BASE TUSCAN
CWCB12TS	215	COLUMN WRAP CAP BASE TUSCAN
CWCB8X12TS	219	COLUMN WRAP CAP BASE TUSCAN
CWCB11X16TS	219	COLUMN WRAP CAP BASE TUSCAN
CWCB13X20TS	219	COLUMN WRAP CAP BASE TUSCAN
CWCB16X24TS	219	COLUMN WRAP CAP BASE TUSCAN
CWINSTALLKIT	205	INSTALLATION KIT
COLUMN WRAP EVERCEDAR		
CWEVFLT6X96SFT	207	COLUMN WRAP EVERCEDAR SQUARE FLAT
CWEVFLT6X108SFT	207	COLUMN WRAP EVERCEDAR SQUARE FLAT
CWEVFLT6X120SFT	207	COLUMN WRAP EVERCEDAR SQUARE FLAT
CWEVFLT8X96SFT	207	COLUMN WRAP EVERCEDAR SQUARE FLAT
CWEVFLT8X108SFT	207	COLUMN WRAP EVERCEDAR SQUARE FLAT

PART NUMBER	PAGE	DESCRIPTION
CWEVFLT8X120SFT	207	COLUMN WRAP EVERCEDAR SQUARE FLAT
CWEVFLT10X96SFT	207	COLUMN WRAP EVERCEDAR SQUARE FLAT
CWEVFLT10X108SFT	207	COLUMN WRAP EVERCEDAR SQUARE FLAT
CWEVFLT10X120SFT	207	COLUMN WRAP EVERCEDAR SQUARE FLAT
CWEVFLT12X96SFT	207	COLUMN WRAP EVERCEDAR SQUARE FLAT
CWEVFLT12X108SFT	207	COLUMN WRAP EVERCEDAR SQUARE FLAT
CWEVFLT12X120SFT	207	COLUMN WRAP EVERCEDAR SQUARE FLAT
CWEVFLT8X12X48TFT	208	COLUMN WRAP EVERCEDAR TAPERED FLAT
CWEVFLT8X12X54TFT	208	COLUMN WRAP EVERCEDAR TAPERED FLAT
CWEVFLT8X12X60TFT	208	COLUMN WRAP EVERCEDAR TAPERED FLAT
CWEVFLT8X12X66TFT	208	COLUMN WRAP EVERCEDAR TAPERED FLAT
CWEVFLT8X12X72TFT	208	COLUMN WRAP EVERCEDAR TAPERED FLAT
CWEVFLT8X12X96TFT	208	COLUMN WRAP EVERCEDAR TAPERED FLAT
CWEVFLT11X16X48TFT	208	COLUMN WRAP EVERCEDAR TAPERED FLAT
CWEVFLT11X16X54TFT	208	COLUMN WRAP EVERCEDAR TAPERED FLAT
CWEVFLT11X16X60TFT	208	COLUMN WRAP EVERCEDAR TAPERED FLAT
CWEVFLT11X16X66TFT	208	COLUMN WRAP EVERCEDAR TAPERED FLAT
CWEVFLT11X16X72TFT	208	COLUMN WRAP EVERCEDAR TAPERED FLAT
CWEVFLT11X16X96TFT	208	COLUMN WRAP EVERCEDAR TAPERED FLAT
<b>COLUMN WRAP PREMIUMSELECT</b>		
CWPM6X72SFT	213	PREMIUMSELECT SQUARE FLAT
CWPM6X96SFT	213	PREMIUMSELECT SQUARE FLAT
CWPM6X108SFT	213	PREMIUMSELECT SQUARE FLAT
CWPM6X120SFT	213	PREMIUMSELECT SQUARE FLAT
CWPM6X144SFT	213	PREMIUMSELECT SQUARE FLAT
CWPM8X72SFT	213	PREMIUMSELECT SQUARE FLAT
CWPM8X96SFT	213	PREMIUMSELECT SQUARE FLAT
CWPM8X108SFT	213	PREMIUMSELECT SQUARE FLAT
CWPM8X120SFT	213	PREMIUMSELECT SQUARE FLAT
CWPM8X144SFT	213	PREMIUMSELECT SQUARE FLAT
CWPM10X72SFT	213	PREMIUMSELECT SQUARE FLAT
CWPM10X96SFT	213	PREMIUMSELECT SQUARE FLAT
CWPM10X108SFT	213	PREMIUMSELECT SQUARE FLAT
CWPM10X120SFT	213	PREMIUMSELECT SQUARE FLAT
CWPM10X144SFT	213	PREMIUMSELECT SQUARE FLAT
CWPM12X72SFT	213	PREMIUMSELECT SQUARE FLAT
CWPM12X96SFT	213	PREMIUMSELECT SQUARE FLAT
CWPM12X108SFT	213	PREMIUMSELECT SQUARE FLAT
CWPM12X120SFT	213	PREMIUMSELECT SQUARE FLAT
CWPM12X144SFT	213	PREMIUMSELECT SQUARE FLAT
CWPM8X72SFL	213	PREMIUMSELECT SQUARE FLUTED
CWPM8X96SFL	213	PREMIUMSELECT SQUARE FLUTED
CWPM8X108SFL	213	PREMIUMSELECT SQUARE FLUTED
CWPM8X120SFL	213	PREMIUMSELECT SQUARE FLUTED
CWPM8X144SFL	213	PREMIUMSELECT SQUARE FLUTED
CWPM10X72SFL	213	PREMIUMSELECT SQUARE FLUTED

PART NUMBER	PAGE	DESCRIPTION
CWPM10X96SFL	213	PREMIUMSELECT SQUARE FLUTED
CWPM10X108SFL	213	PREMIUMSELECT SQUARE FLUTED
CWPM10X120SFL	213	PREMIUMSELECT SQUARE FLUTED
CWPM10X144SFL	213	PREMIUMSELECT SQUARE FLUTED
CWPM12X72SFL	213	PREMIUMSELECT SQUARE FLUTED
CWPM12X96SFL	213	PREMIUMSELECT SQUARE FLUTED
CWPM12X108SFL	213	PREMIUMSELECT SQUARE FLUTED
CWPM12X120SFL	213	PREMIUMSELECT SQUARE FLUTED
CWPM12X144SFL	213	PREMIUMSELECT SQUARE FLUTED
CWPM8X72SRS	213	PREMIUMSELECT SQUARE RAISED
CWPM8X96SRS	213	PREMIUMSELECT SQUARE RAISED
CWPM8X108SRS	213	PREMIUMSELECT SQUARE RAISED
CWPM8X120SRS	213	PREMIUMSELECT SQUARE RAISED
CWPM8X144SRS	213	PREMIUMSELECT SQUARE RAISED
CWPM10X72SRS	213	PREMIUMSELECT SQUARE RAISED
CWPM10X96SRS	213	PREMIUMSELECT SQUARE RAISED
CWPM10X108SRS	213	PREMIUMSELECT SQUARE RAISED
CWPM10X120SRS	213	PREMIUMSELECT SQUARE RAISED
CWPM10X144SRS	213	PREMIUMSELECT SQUARE RAISED
CWPM12X72SRS	213	PREMIUMSELECT SQUARE RAISED
CWPM12X96SRS	213	PREMIUMSELECT SQUARE RAISED
CWPM12X108SRS	213	PREMIUMSELECT SQUARE RAISED
CWPM12X120SRS	213	PREMIUMSELECT SQUARE RAISED
CWPM12X144SRS	213	PREMIUMSELECT SQUARE RAISED
CWPM8X72SRC	213	PREMIUMSELECT SQUARE RECESSED
CWPM8X96SRC	213	PREMIUMSELECT SQUARE RECESSED
CWPM8X108SRC	213	PREMIUMSELECT SQUARE RECESSED
CWPM8X120SRC	213	PREMIUMSELECT SQUARE RECESSED
CWPM8X144SRC	213	PREMIUMSELECT SQUARE RECESSED
CWPM10X72SRC	213	PREMIUMSELECT SQUARE RECESSED
CWPM10X96SRC	213	PREMIUMSELECT SQUARE RECESSED
CWPM10X108SRC	213	PREMIUMSELECT SQUARE RECESSED
CWPM10X120SRC	213	PREMIUMSELECT SQUARE RECESSED
CWPM10X144SRC	213	PREMIUMSELECT SQUARE RECESSED
CWPM12X72SRC	213	PREMIUMSELECT SQUARE RECESSED
CWPM12X96SRC	213	PREMIUMSELECT SQUARE RECESSED
CWPM12X108SRC	213	PREMIUMSELECT SQUARE RECESSED
CWPM12X120SRC	213	PREMIUMSELECT SQUARE RECESSED
CWPM12X144SRC	213	PREMIUMSELECT SQUARE RECESSED
CWPM8X12X48TFT	216	PREMIUMSELECT TAPERED FLAT
CWPM8X12X54TFT	216	PREMIUMSELECT TAPERED FLAT
CWPM8X12X60TFT	216	PREMIUMSELECT TAPERED FLAT
CWPM8X12X66TFT	216	PREMIUMSELECT TAPERED FLAT
CWPM8X12X72TFT	216	PREMIUMSELECT TAPERED FLAT
CWPM8X12X96TFT	216	PREMIUMSELECT TAPERED FLAT
CWPM11X16X48TFT	216	PREMIUMSELECT TAPERED FLAT

PART NUMBER	PAGE	DESCRIPTION
CWPM11X16X54TFT	216	PREMIUMSELECT TAPERED FLAT
CWPM11X16X60TFT	216	PREMIUMSELECT TAPERED FLAT
CWPM11X16X66TFT	216	PREMIUMSELECT TAPERED FLAT
CWPM11X16X72TFT	216	PREMIUMSELECT TAPERED FLAT
CWPM11X16X96TFT	216	PREMIUMSELECT TAPERED FLAT
CWPM13X20X48TFT	216	PREMIUMSELECT TAPERED FLAT
CWPM13X20X54TFT	216	PREMIUMSELECT TAPERED FLAT
CWPM13X20X60TFT	216	PREMIUMSELECT TAPERED FLAT
CWPM13X20X66TFT	216	PREMIUMSELECT TAPERED FLAT
CWPM13X20X72TFT	216	PREMIUMSELECT TAPERED FLAT
CWPM13X20X96TFT	216	PREMIUMSELECT TAPERED FLAT
CWPM16X24X48TFT	216	PREMIUMSELECT TAPERED FLAT
CWPM16X24X54TFT	216	PREMIUMSELECT TAPERED FLAT
CWPM16X24X60TFT	216	PREMIUMSELECT TAPERED FLAT
CWPM16X24X66TFT	216	PREMIUMSELECT TAPERED FLAT
CWPM16X24X72TFT	216	PREMIUMSELECT TAPERED FLAT
CWPM16X24X96TFT	216	PREMIUMSELECT TAPERED FLAT
CWPM8X12X48TRS	216	PREMIUMSELECT TAPERED RAISED
CWPM8X12X54TRS	216	PREMIUMSELECT TAPERED RAISED
CWPM8X12X60TRS	216	PREMIUMSELECT TAPERED RAISED
CWPM8X12X66TRS	216	PREMIUMSELECT TAPERED RAISED
CWPM8X12X72TRS	216	PREMIUMSELECT TAPERED RAISED
CWPM8X12X96TRS	216	PREMIUMSELECT TAPERED RAISED
CWPM11X16X48TRS	216	PREMIUMSELECT TAPERED RAISED
CWPM11X16X54TRS	216	PREMIUMSELECT TAPERED RAISED
CWPM11X16X60TRS	216	PREMIUMSELECT TAPERED RAISED
CWPM11X16X66TRS	216	PREMIUMSELECT TAPERED RAISED
CWPM11X16X72TRS	216	PREMIUMSELECT TAPERED RAISED
CWPM11X16X96TRS	216	PREMIUMSELECT TAPERED RAISED
CWPM13X20X48TRS	216	PREMIUMSELECT TAPERED RAISED
CWPM13X20X54TRS	216	PREMIUMSELECT TAPERED RAISED
CWPM13X20X60TRS	216	PREMIUMSELECT TAPERED RAISED
CWPM13X20X66TRS	216	PREMIUMSELECT TAPERED RAISED
CWPM13X20X72TRS	216	PREMIUMSELECT TAPERED RAISED
CWPM13X20X96TRS	216	PREMIUMSELECT TAPERED RAISED
CWPM16X24X48TRS	216	PREMIUMSELECT TAPERED RAISED
CWPM16X24X54TRS	216	PREMIUMSELECT TAPERED RAISED
CWPM16X24X60TRS	216	PREMIUMSELECT TAPERED RAISED
CWPM16X24X66TRS	216	PREMIUMSELECT TAPERED RAISED
CWPM16X24X72TRS	216	PREMIUMSELECT TAPERED RAISED
CWPM16X24X96TRS	216	PREMIUMSELECT TAPERED RAISED
CWPM8X12X48TRC	216	PREMIUMSELECT TAPERED RECESSED
CWPM8X12X54TRC	216	PREMIUMSELECT TAPERED RECESSED
CWPM8X12X60TRC	216	PREMIUMSELECT TAPERED RECESSED
CWPM8X12X66TRC	216	PREMIUMSELECT TAPERED RECESSED

PART NUMBER	PAGE	DESCRIPTION
CWPM8X12X72TRC	216	PREMIUMSELECT TAPERED RECESSED
CWPM8X12X96TRC	216	PREMIUMSELECT TAPERED RECESSED
CWPM11X16X48TRC	216	PREMIUMSELECT TAPERED RECESSED
CWPM11X16X54TRC	216	PREMIUMSELECT TAPERED RECESSED
CWPM11X16X60TRC	216	PREMIUMSELECT TAPERED RECESSED
CWPM11X16X66TRC	216	PREMIUMSELECT TAPERED RECESSED
CWPM11X16X72TRC	216	PREMIUMSELECT TAPERED RECESSED
CWPM11X16X96TRC	216	PREMIUMSELECT TAPERED RECESSED
CWPM13X20X48TRC	216	PREMIUMSELECT TAPERED RECESSED
CWPM13X20X54TRC	216	PREMIUMSELECT TAPERED RECESSED
CWPM13X20X60TRC	216	PREMIUMSELECT TAPERED RECESSED
CWPM13X20X66TRC	216	PREMIUMSELECT TAPERED RECESSED
CWPM13X20X72TRC	216	PREMIUMSELECT TAPERED RECESSED
CWPM13X20X96TRC	216	PREMIUMSELECT TAPERED RECESSED
CWPM16X24X48TRC	216	PREMIUMSELECT TAPERED RECESSED
CWPM16X24X54TRC	216	PREMIUMSELECT TAPERED RECESSED
CWPM16X24X60TRC	216	PREMIUMSELECT TAPERED RECESSED
CWPM16X24X66TRC	216	PREMIUMSELECT TAPERED RECESSED
CWPM16X24X72TRC	216	PREMIUMSELECT TAPERED RECESSED
CWPM16X24X96TRC	216	PREMIUMSELECT TAPERED RECESSED
<b>COLUMN WRAP PREMIUMSELECT FLAT-PACK</b>		
CWPMFLT6X6X96SFT	214	PREMIUMSELECT FLAT-PACK SQUARE FLAT COLUMN WRAP
CWPMFLT6X6X108SFT	214	PREMIUMSELECT FLAT-PACK SQUARE FLAT COLUMN WRAP
CWPMFLT6X6X120SFT	214	PREMIUMSELECT FLAT-PACK SQUARE FLAT COLUMN WRAP
CWPMFLT8X8X96SFT	214	PREMIUMSELECT FLAT-PACK SQUARE FLAT COLUMN WRAP
CWPMFLT8X8X108SFT	214	PREMIUMSELECT FLAT-PACK SQUARE FLAT COLUMN WRAP
CWPMFLT8X8X120SFT	214	PREMIUMSELECT FLAT-PACK SQUARE FLAT COLUMN WRAP
CWPMFLT10X10X96SFT	214	PREMIUMSELECT FLAT-PACK SQUARE FLAT COLUMN WRAP
CWPMFLT10X10X108SFT	214	PREMIUMSELECT FLAT-PACK SQUARE FLAT COLUMN WRAP
CWPMFLT10X10X120SFT	214	PREMIUMSELECT FLAT-PACK SQUARE FLAT COLUMN WRAP
CWPMFLT8X12X60TFT	218	PREMIUMSELECT FLAT-PACK TAPERED FLAT COLUMN WRAP
CWPMFLT8X12X66TFT	218	PREMIUMSELECT FLAT-PACK TAPERED FLAT COLUMN WRAP
CWPMFLT8X12X72TFT	218	PREMIUMSELECT FLAT-PACK TAPERED FLAT COLUMN WRAP
CWPMFLT11X16X60TFT	218	PREMIUMSELECT FLAT-PACK TAPERED FLAT COLUMN WRAP
CWPMFLT11X16X66TFT	218	PREMIUMSELECT FLAT-PACK TAPERED FLAT COLUMN WRAP
CWPMFLT11X16X72TFT	218	PREMIUMSELECT FLAT-PACK TAPERED FLAT COLUMN WRAP
<b>COLUMN WRAP PROSELECT</b>		
CWPR6X72SFT	210	PROSELECT SQUARE FLAT
CWPR6X96SFT	210	PROSELECT SQUARE FLAT
CWPR6X108SFT	210	PROSELECT SQUARE FLAT
CWPR6X120SFT	210	PROSELECT SQUARE FLAT
CWPR6X144SFT	210	PROSELECT SQUARE FLAT
CWPR8X72SFT	210	PROSELECT SQUARE FLAT
CWPR8X96SFT	210	PROSELECT SQUARE FLAT
CWPR8X108SFT	210	PROSELECT SQUARE FLAT

PART NUMBER	PAGE	DESCRIPTION
CWPR8X120SFT	210	PROSELECT SQUARE FLAT
CWPR8X144SFT	210	PROSELECT SQUARE FLAT
CWPR10X72SFT	210	PROSELECT SQUARE FLAT
CWPR10X96SFT	210	PROSELECT SQUARE FLAT
CWPR10X108SFT	210	PROSELECT SQUARE FLAT
CWPR10X120SFT	210	PROSELECT SQUARE FLAT
CWPR10X144SFT	210	PROSELECT SQUARE FLAT
CWPR12X72SFT	210	PROSELECT SQUARE FLAT
CWPR12X96SFT	210	PROSELECT SQUARE FLAT
CWPR12X108SFT	210	PROSELECT SQUARE FLAT
CWPR12X120SFT	210	PROSELECT SQUARE FLAT
CWPR12X144SFT	210	PROSELECT SQUARE FLAT
COLUMN WRAP PROSELECT FLAT-PACK		
CWPRFLT6X6X96SFT	211	PROSELECT FLAT-PACK SQUARE FLAT COLUMN WRAP
CWPRFLT6X6X108SFT	211	PROSELECT FLAT-PACK SQUARE FLAT COLUMN WRAP
D		
DLV24X24	201	DIAMOND LOUVER DECO SMOOTH
DMP44	54	DORMER TRIM SYSTEM PEDIMENT SMOOTH
DMR457-10	54	DORMER TRIM SYSTEM RETURN SMOOTH
DMST7X69	54	DORMER TRIM SYSTEM SIDE TRIM SMOOTH
DP28X28SQX	178	DECORATIVE PANEL SQUARE SMOOTH
DTLB3X3X3	141	DENTIL BLOCK SMOOTH
DTLB3X3X4	145	DENTIL BLOCK SMOOTH
DTLB3X5X6	143	DENTIL BLOCK SMOOTH
DTLB3.5X3.5X7	141	DENTIL BLOCK SMOOTH
DTLB3.5X5.5X5.5	145	DENTIL BLOCK SMOOTH
DTLB4X4X4	145	DENTIL BLOCK SMOOTH
DTLB4X4X7	143	DENTIL BLOCK SMOOTH
DTLB4X4X9	143	DENTIL BLOCK SMOOTH
DTLB4X5X7	145	DENTIL BLOCK SMOOTH
DTLB4X5X8	142	DENTIL BLOCK SMOOTH
DTLB4X6X6	143	DENTIL BLOCK SMOOTH
DTLB4X6X7	144	DENTIL BLOCK SMOOTH
DTLB4X6X9	141	DENTIL BLOCK SMOOTH
DTLB5X4X7	144	DENTIL BLOCK SMOOTH
DTLB5X5X3	141	DENTIL BLOCK SMOOTH
DTLB5X6X6	141	DENTIL BLOCK SMOOTH
DTLB5X6X8	141	DENTIL BLOCK SMOOTH
DTLB5X6X10	142	DENTIL BLOCK SMOOTH
DTLB5X6X11	144	DENTIL BLOCK SMOOTH
DTLB5X6X18	141	DENTIL BLOCK SMOOTH
DTLB5X8	143	DENTIL BLOCK SMOOTH
DTLB5X8X10	144	DENTIL BLOCK SMOOTH
DTLB6X4X6	144	DENTIL BLOCK SMOOTH
DTLB6X4X6L12	145	DENTIL BLOCK SMOOTH

PART NUMBER	PAGE	DESCRIPTION
DTLB6X4X6R12	145	DENTIL BLOCK SMOOTH
DTLB6X5X7	144	DENTIL BLOCK SMOOTH
DTLB6X6X5	144	DENTIL BLOCK SMOOTH
DTLB6X6X8	144	DENTIL BLOCK SMOOTH
DTLB6X6X9	143	DENTIL BLOCK SMOOTH
DTLB6X6X9.25	144	DENTIL BLOCK SMOOTH
DTLB6X7X9	143	DENTIL BLOCK SMOOTH
DTLB6X9X7	142	DENTIL BLOCK SMOOTH
DTLB8X6X6	145	DENTIL BLOCK SMOOTH
DTLB9X8X8	143	DENTIL BLOCK SMOOTH
DTLB9X11X16	143	DENTIL BLOCK SMOOTH
DVP40	44	PEDIMENT DLX VICTORIAN SMOOTH
E		
EBLV12X24	189	EYEBROW LOUVER DECO SMOOTH
EBLV18X30	189	EYEBROW LOUVER DECO SMOOTH
EBLV22X32	189	EYEBROW LOUVER DECO SMOOTH
ESWDH76X23	36	PEDIMENT ELLIPTICAL SUNBURST W/DECO TRIM SMOOTH
EV570	118	E-VENT COMBINATION CROWN
EV570B	118	E-VENT JOINING BLOCK/END CAP
EV570MI	118	E-VENT MITERED INSIDE CORNER
EV570MO	118	E-VENT MITERED OUTSIDE CORNER
EV580	119	E-VENT MASSIVE CROWN
EV580B	119	E-VENT JOINING BLOCK/END CAP
EV580MI	119	E-VENT MITERED INSIDE CORNER
EV580MO	119	E-VENT MITERED OUTSIDE CORNER
EVFB	118,119	E-VENT FILLER BLOCK
F		
F100	141	DENTIL BLOCK SMOOTH
FCLV12X24	184	LOUVER FUNC CATHEDRAL SMOOTH
FCLV14X22	184	LOUVER FUNC CATHEDRAL SMOOTH
FCLV16X36	184	LOUVER FUNC CATHEDRAL SMOOTH
FCLV18X24	184	LOUVER FUNC CATHEDRAL SMOOTH
FCLV18X30	184	LOUVER FUNC CATHEDRAL SMOOTH
FCLV18X54	184	LOUVER FUNC CATHEDRAL SMOOTH
FCLV22X31	184	LOUVER FUNC CATHEDRAL SMOOTH
FCLV24X48	184	LOUVER FUNC CATHEDRAL SMOOTH
FCLV28X43	184	LOUVER FUNC CATHEDRAL SMOOTH
FCLV36X48	184	LOUVER FUNC CATHEDRAL SMOOTH
FDLV24X24	201	LOUVER FUNC DIAMOND SMOOTH
FEVLV12X24	189	LOUVER FUNC EYEBROW SMOOTH
FEVLV18X30	189	LOUVER FUNC EYEBROW SMOOTH
FEVLV22X32	189	LOUVER FUNC EYEBROW SMOOTH
FHRLV24X12	194	LOUVER FUNC HALF ROUND SMOOTH
FHRLV28X14	194	LOUVER FUNC HALF ROUND SMOOTH
FHRLV29-6FKWD	195	LOUVER FUNC HALF ROUND W/DECO T,D,K SMOOTH

PART NUMBER	PAGE	DESCRIPTION
FHRLV32X16	194	LOUVER FUNC HALF ROUND SMOOTH
FHRLV36X18	194	LOUVER FUNC HALF ROUND SMOOTH
FHRLV36X18-4F	195	LOUVER FUNC HALF ROUND W/ FL TRIM SMOOTH
FHRLV36X18-6F	195	LOUVER FUNC HALF ROUND W/ FL TRIM SMOOTH
FHRLV36X18MTK	195	LOUVER FUNC HALF ROUND W/DECO T,K SMOOTH
FHRLV40X20	194	LOUVER FUNC HALF ROUND SMOOTH
FHRLV42X21	194	LOUVER FUNC HALF ROUND SMOOTH
FHRLV48X24	194	LOUVER FUNC HALF ROUND SMOOTH
FHRLV60X30	194	LOUVER FUNC HALF ROUND SMOOTH
FHRLV72X36	194	LOUVER FUNC HALF ROUND SMOOTH
FLT1X3-12	86	FLAT TRIM, RAIL SHAKER SHUTTER
FLT1X4-12RS	89	BATTEN, TIMBER TEXTURE
FLT9X4X216S	89	FLAT TRIM, TIMBER TEXTURE
FLT30X228X1S	89	FLAT TRIM, TIMBER TEXTURE
FLT40X96	54,87	WINDOW PANEL FLAT SMOOTH
FLT100-12	86	FLAT TRIM SMOOTH
FLT101-12	86	FLAT TRIM SMOOTH
FLT102-10	86	FLAT TRIM SMOOTH
FLT103-12	86	FLAT TRIM SMOOTH
FLT109-12	86	FLAT TRIM SMOOTH
FLT110-12S	89	FLAT TRIM, TIMBER TEXTURE
FLT110-16	86	FLAT TRIM SMOOTH
FLT111-12S	89	FLAT TRIM, TIMBER TEXTURE
FLT113-8	86	FLAT TRIM SMOOTH
FLT118-8	86	FLAT TRIM SMOOTH
FLT119-17	87	FLAT TRIM SMOOTH
FLT122-16	86	FLAT TRIM SMOOTH
FLT125-8	87	FLAT TRIM SMOOTH
FLT131-16	86	FLAT TRIM SMOOTH
FLT150-12S	89	FLAT TRIM, TIMBER TEXTURE
FLT151-12S	89	FLAT TRIM, TIMBER TEXTURE
FLT152-12	86	FLAT TRIM SMOOTH
FLT152-16	86	FLAT TRIM SMOOTH
FLT152-8	86	FLAT TRIM SMOOTH
FLT153-12	86	FLAT TRIM SMOOTH
FLT159-12	86	FLAT TRIM SMOOTH
FLT159-16	86	FLAT TRIM SMOOTH
FLT159-8	86	FLAT TRIM SMOOTH
FLT162-14	86	FLAT TRIM SMOOTH
FLT162-8	86	FLAT TRIM SMOOTH
FLT163-16	87	FLAT TRIM SMOOTH
FLT170-12	86	FLAT TRIM SMOOTH
FLT170-16	86	FLAT TRIM SMOOTH
FLT172-16	86	FLAT TRIM SMOOTH
FLT173-12S	89	FLAT TRIM, TIMBER TEXTURE

PART NUMBER	PAGE	DESCRIPTION
FLT175-12	87	FLAT TRIM SMOOTH
FLT178-8	86	FLAT TRIM SMOOTH
FLT179-12	87	FLAT TRIM SMOOTH
FLT180-12	87	FLAT TRIM SMOOTH
FLT181-8	86	FLAT TRIM SMOOTH
FLT182-12	87	FLAT TRIM SMOOTH
FLT183-12	87	FLAT TRIM SMOOTH
FLT185-12	87	FLAT TRIM SMOOTH
FLT186-16	86	FLAT TRIM SMOOTH
FLT187-12S	89	FLAT TRIM, TIMBER TEXTURE
FLT190-12	87	FLAT TRIM SMOOTH
FLT192-12S	89	FLAT TRIM, TIMBER TEXTURE
FLT194-10	87	FLAT TRIM SMOOTH
FLT197-12S	89	FLAT TRIM, TIMBER TEXTURE
FLTBA36X3X3	158	TRELLIS LATTICE SMOOTH
FLTBA36X3X3S	159	LATTICE, TIMBER TEXTURE
FLV8X15	190	LOUVER FUNC RECT VERT SMOOTH
FLV8X24	190	LOUVER FUNC RECT VERT SMOOTH
FLV8X30	190	LOUVER FUNC RECT VERT SMOOTH
FLV12X18	190	LOUVER FUNC RECT VERT SMOOTH
FLV12X24	190	LOUVER FUNC RECT VERT SMOOTH
FLV12X30	190	LOUVER FUNC RECT VERT SMOOTH
FLV12X36	190	LOUVER FUNC RECT VERT SMOOTH
FLV12X40	190	LOUVER FUNC RECT VERT SMOOTH
FLV14X27	190	LOUVER FUNC RECT VERT SMOOTH
FLV14X30	190	LOUVER FUNC RECT VERT SMOOTH
FLV14X32	190	LOUVER FUNC RECT VERT SMOOTH
FLV16X24	190	LOUVER FUNC RECT VERT SMOOTH
FLV16X36	190	LOUVER FUNC RECT VERT SMOOTH
FLV18X24	190	LOUVER FUNC RECT VERT SMOOTH
FLV18X24-4F6WCH	192	LOUVER FUNC RECT VERT W/TRIM & CRSHD SMOOTH
FLV18X30	190	LOUVER FUNC RECT VERT SMOOTH
FLV18X36	190	LOUVER FUNC RECT VERT SMOOTH
FLV18X42	190	LOUVER FUNC RECT VERT SMOOTH
FLV20X28	190	LOUVER FUNC RECT VERT SMOOTH
FLV24X24	190	LOUVER FUNC RECT VERT SMOOTH
FLV24X30	190	LOUVER FUNC RECT VERT SMOOTH
FLV24X36	190	LOUVER FUNC RECT VERT SMOOTH
FLV24X48	190	LOUVER FUNC RECT VERT SMOOTH
FLV27X17	193	LOUVER FUNC RECT VERT SMOOTH
FLV30X42	190	LOUVER FUNC RECT VERT SMOOTH
FLV32X16	193	LOUVER FUNC RECT VERT SMOOTH
FLVNS18X24	192	LOUVER FUNC RECT VERT NO SILL SMOOTH
FM8X12X2	181	FIXTURE MOUNT SMOOTH
FMS8X8X2	181	FIXTURE MOUNT SMOOTH



PART NUMBER	PAGE	DESCRIPTION
FOLV18	201	LOUVER FUNC OCTAGON SMOOTH
FOLV22	201	LOUVER FUNC OCTAGON SMOOTH
FOLV24	201	LOUVER FUNC OCTAGON SMOOTH
FOLV28	201	LOUVER FUNC OCTAGON SMOOTH
FOVL28X35K215V	199	LOUVER FUNC OVAL VERT W/ DC TRIM & KEY SMOOTH
FOVL35X28K215	199	LOUVER FUNC OVAL HORZ W/ DC TRIM & KEY SMOOTH
FOVLV18X24V	198	LOUVER FUNC OVAL VERT SMOOTH
FOVLV20X29VTK	199	LOUVER FUNC OVAL VERT W/ FL TRIM & KEY SMOOTH
FOVLV25X37V	198	LOUVER FUNC OVAL VERT SMOOTH
FP9X168	50	FLUTED PANEL TRIM SMOOTH
FP12X96	50	FLUTED PANEL TRIM SMOOTH
FPLV18X24-8	189	LOUVER FUNC PEAKED SMOOTH
FPLV18X36-10	189	LOUVER FUNC PEAKED SMOOTH
FPLV24X30-10	189	LOUVER FUNC PEAKED SMOOTH
FPLV24X36-10	189	LOUVER FUNC PEAKED SMOOTH
FPLV24X36-12	189	LOUVER FUNC PEAKED SMOOTH
FRLV12	196	LOUVER FUNC ROUND SMOOTH
FRLV16	196	LOUVER FUNC ROUND SMOOTH
FRLV16MTK	197	LOUVER FUNC ROUND W/ DC TRIM & KEY SMOOTH
FRLV18	196	LOUVER FUNC ROUND SMOOTH
FRLV18MTK	197	LOUVER FUNC ROUND W/ DC TRIM & KEY SMOOTH
FRLV22	196	LOUVER FUNC ROUND SMOOTH
FRLV24	196	LOUVER FUNC ROUND SMOOTH
FRLV24-4FTK	197	LOUVER FUNC ROUND W/ DC TRIM & KEY SMOOTH
FRLV24-6TK	197	LOUVER FUNC ROUND W/ FL TRIM & FLAT KEY SMOOTH
FRLV24MTK	197	LOUVER FUNC ROUND W/ DC TRIM & KEY SMOOTH
FRLV24TK	198	LOUVER FUNC ROUND W/ FL TRIM & FLAT KEY SMOOTH
FRLV28	196	LOUVER FUNC ROUND SMOOTH
FRLV30	196	LOUVER FUNC ROUND SMOOTH
FRLV30-6TK	197	LOUVER FUNC ROUND W/ FL TRIM & FLAT KEY SMOOTH
FRLV30MTK	197	LOUVER FUNC ROUND W/ DC TRIM & KEY SMOOTH
FRLV30TK	198	LOUVER FUNC ROUND W/ FL TRIM & FLAT KEY SMOOTH
FRLV32-2F	196	LOUVER FUNC ROUND W/ FL TRIM SMOOTH
FRLV32MTK	197	LOUVER FUNC ROUND W/ DC TRIM & KEY SMOOTH
FRLV32TK	198	LOUVER FUNC ROUND W/ FL TRIM & KEY SMOOTH
FRLV36	196	LOUVER FUNC ROUND SMOOTH
FRLV36TK	198	LOUVER FUNC ROUND W/ FL TRIM & FK SMOOTH
FRLV40MTK	197	LOUVER FUNC ROUND W/ DC TRIM & KEY SMOOTH
FRLV42	196	LOUVER FUNC ROUND SMOOTH
FRLV48	196	LOUVER FUNC ROUND SMOOTH
FSR103X17	179	FISHSCALE PANEL SMOOTH
FTRLV36X18	200	LOUVER FUNC TRIANGLE SMOOTH
FTRLV42X21	200	LOUVER FUNC TRIANGLE SMOOTH
FTRLV48X12	200	LOUVER FUNC TRIANGLE SMOOTH
FTRLV48X18	200	LOUVER FUNC TRIANGLE SMOOTH

PART NUMBER	PAGE	DESCRIPTION
FTRLV48X22	200	LOUVER FUNC TRIANGLE SMOOTH
FTRLV48X24	200	LOUVER FUNC TRIANGLE SMOOTH
FTRLV60X18	200	LOUVER FUNC TRIANGLE SMOOTH
FTRLV60X23	200	LOUVER FUNC TRIANGLE SMOOTH
FTRLV60X25	200	LOUVER FUNC TRIANGLE SMOOTH
FTRLV60X30	200	LOUVER FUNC TRIANGLE SMOOTH
FTRLV64X27	200	LOUVER FUNC TRIANGLE SMOOTH
FTRLV64X32	200	LOUVER FUNC TRIANGLE SMOOTH
FTRLV66X22	200	LOUVER FUNC TRIANGLE SMOOTH
FTRLV72X36	200	LOUVER FUNC TRIANGLE SMOOTH
FTRLV76X19	200	LOUVER FUNC TRIANGLE SMOOTH
FTRLV84X18	200	LOUVER FUNC TRIANGLE SMOOTH
FTRLV84X21	200	LOUVER FUNC TRIANGLE SMOOTH
FTRLV88X22	200	LOUVER FUNC TRIANGLE SMOOTH
FTRLVLR60X25	201	LOUVER FUNC 2PC TRIANGLE SMOOTH
FTRLVLR60X30	201	LOUVER FUNC 2PC TRIANGLE SMOOTH
FTRLVLR108X27	201	LOUVER FUNC 2PC TRIANGLE SMOOTH
FTRLVLR115X35	201	LOUVER FUNC 2PC TRIANGLE SMOOTH
FTRLVLR120X30	201	LOUVER FUNC 2PC TRIANGLE SMOOTH
<b>G</b>		
GP64X32	174	GABLE PEDIMENT VICTORIAN SMOOTH
GP80X33	174	GABLE PEDIMENT VICTORIAN SMOOTH
GP81X31	174	GABLE PEDIMENT VICTORIAN SMOOTH
GP88X29	174	GABLE PEDIMENT VICTORIAN SMOOTH
GP96X28	174	GABLE PEDIMENT VICTORIAN SMOOTH
GP107X22	174	GABLE PEDIMENT VICTORIAN SMOOTH
GP110X27	174	GABLE PEDIMENT VICTORIAN SMOOTH
GPA70X35	174	GABLE PEDIMENT ARCHED SMOOTH
GPA81X34	174	GABLE PEDIMENT ARCHED SMOOTH
GPA86X32	174	GABLE PEDIMENT ARCHED SMOOTH
GPA87X29	174	GABLE PEDIMENT ARCHED SMOOTH
GPA95X28	174	GABLE PEDIMENT ARCHED SMOOTH
GPA104X26	174	GABLE PEDIMENT ARCHED SMOOTH
GPF66X33	175	GABLE PEDIMENT FLAT SMOOTH
GPK100	176	GABLE PEDIMENT BASIC SMOOTH
GPK401	176	GABLE PEDIMENT STEWART SMOOTH
GPK451	176	GABLE PEDIMENT STEWART CENTER SMOOTH
GPK801	176	GABLE PEDIMENT STEWART SMOOTH
GPK851	176	GABLE PEDIMENT STEWART CENTER SMOOTH
<b>H</b>		
HRCBCC96X12ST	257	COLUMN SET, STONE TEXTURE
HRLV24X12	194	HALF ROUND LOUVER DECO SMOOTH
HRLV28X14	194	HALF ROUND LOUVER DECO SMOOTH
HRLV29-6FKWD	195	LOUVER DECO HALF ROUND W/DECO T,D,K SMOOTH
HRLV32X16	194	HALF ROUND LOUVER DECO SMOOTH

PART NUMBER	PAGE	DESCRIPTION
HRLV36X18	194	HALF ROUND LOUVER DECO SMOOTH
HRLV36X18-4F	195	HALF ROUND W/ FL TRIM LOUVER DECO SMOOTH
HRLV36X18-6F	194	HALF ROUND W/ FL TRIM LOUVER DECO SMOOTH
HRLV36X18MTK	194	LOUVER DECO HALF ROUND W/ DC TRIM & KEY SMOOTH
HRLV40X20	194	HALF ROUND LOUVER DECO SMOOTH
HRLV42X21	194	HALF ROUND LOUVER DECO SMOOTH
HRLV48X24	194	HALF ROUND LOUVER DECO SMOOTH
HRLV60X30	194	HALF ROUND LOUVER DECO SMOOTH
HRLV72X36	194	HALF ROUND LOUVER DECO SMOOTH
HRSP36X18	36	PEDIMENT HALF ROUND SPKD SMOOTH
HRSP48X24	36	PEDIMENT HALF ROUND SPKD SMOOTH
HRSP72X36	36	PEDIMENT HALF ROUND SPKD SMOOTH
<b>K</b>		
K4TF	55	KEystone TRIM PROFILE SMOOTH
K4TM	55	KEystone TRIM PROFILE SMOOTH
K6	55	KEystone SOLID SMOOTH
K6M	21,55	KEystone CROSSHEAD PROFILE SMOOTH
K6TF	55	KEystone TRIM PROFILE SMOOTH
K6TM	55	KEystone TRIM PROFILE SMOOTH
K8	55	KEystone SOLID SMOOTH
K8TF	55	KEystone TRIM PROFILE SMOOTH
K9M	21,55	KEystone CROSSHEAD PROFILE SMOOTH
K10SEG	55	KEystone CROSSHEAD PROFILE SMOOTH
K10TM	55	KEystone TRIM PROFILE SMOOTH
K12M	55	KEystone CROSSHEAD PROFILE SMOOTH
KCCA10	55	KEystone CROSSHEAD PROFILE SMOOTH
KP4TF	55	KEystone TRIM PROFILE SMOOTH
KP4TM	55	KEystone TRIM PROFILE SMOOTH
KP6M	55	KEystone CROSSHEAD PROFILE SMOOTH
KP6TF	55	KEystone TRIM PROFILE SMOOTH
KP6TM	55	KEystone TRIM PROFILE SMOOTH
KP9M	55	KEystone CROSSHEAD PROFILE SMOOTH
KWM180M	55	KEystone BRICK MOULD PROFILE SMOOTH
<b>L</b>		
LDCH58X18	35	CROSSHEAD LARGE DOOR SMOOTH
LDCH62X18	35	CROSSHEAD LARGE DOOR SMOOTH
LDCH87X18	35	CROSSHEAD LARGE DOOR SMOOTH
LDCH90X18	35	CROSSHEAD LARGE DOOR SMOOTH
LDCH94X18	35	CROSSHEAD LARGE DOOR SMOOTH
LP6X96	253	LAMP POST TAPERED SMOOTH
LV12X18	190	RECTANGLE VERTICAL LOUVER DECO SMOOTH
LV12X24	190	RECTANGLE VERTICAL LOUVER DECO SMOOTH
LV12X30	190	RECTANGLE VERTICAL LOUVER DECO SMOOTH
LV12X36	190	RECTANGLE VERTICAL LOUVER DECO SMOOTH
LV12X40	190	RECTANGLE VERTICAL LOUVER DECO SMOOTH
LV14X27	190	RECTANGLE VERTICAL LOUVER DECO SMOOTH

PART NUMBER	PAGE	DESCRIPTION
LV14X30	190	RECTANGLE VERTICAL LOUVER DECO SMOOTH
LV14X32	190	RECTANGLE VERTICAL LOUVER DECO SMOOTH
LV16X24	190	RECTANGLE VERTICAL LOUVER DECO SMOOTH
LV16X36	190	RECTANGLE VERTICAL LOUVER DECO SMOOTH
LV18X24	190	RECTANGLE VERTICAL LOUVER DECO SMOOTH
LV18X24-4F6WCH	192	LOUVER DECO RECT VRTCL W/TRIM & CRSHD SMOOTH
LV18X30	190	RECTANGLE VERTICAL LOUVER DECO SMOOTH
LV18X30-4F	192	RECTANGLE VERTICAL W/TRIM LOUVER DECO SMOOTH
LV18X36	190	RECTANGLE VERTICAL LOUVER DECO SMOOTH
LV18X42	190	RECTANGLE VERTICAL LOUVER DECO SMOOTH
LV20X28	190	RECTANGLE VERTICAL LOUVER DECO SMOOTH
LV24X24	190	RECTANGLE VERTICAL LOUVER DECO SMOOTH
LV24X30	190	RECTANGLE VERTICAL LOUVER DECO SMOOTH
LV24X36	190	RECTANGLE VERTICAL LOUVER DECO SMOOTH
LV24X48	190	RECTANGLE VERTICAL LOUVER DECO SMOOTH
LV27X17	192	RECTANGLE VERTICAL LOUVER DECO SMOOTH
LV30X42	190	RECTANGLE VERTICAL LOUVER DECO SMOOTH
LV32X16	192	RECTANGLE VERTICAL LOUVER DECO SMOOTH
LV8X15	190	RECTANGLE VERTICAL LOUVER DECO SMOOTH
LV8X24	190	RECTANGLE VERTICAL LOUVER DECO SMOOTH
LV8X30	190	RECTANGLE VERTICAL LOUVER DECO SMOOTH
LVNS18X24	192	RECTANGLE VERTICAL NO SILL LOUVER DECO SMOOTH
LVSH12X36FNCR	56	SHUTTER LOUVERED W/CENTER RAIL SMOOTH
LVSH12X48FNCR	56	SHUTTER LOUVERED W/CENTER RAIL SMOOTH
LVSH16X54FNB	57	SHUTTER LOUVERED SMOOTH
LVSH16X54FNCR	56	SHUTTER LOUVERED W/CENTER RAIL SMOOTH
LVSH16X60FNCR	56	SHUTTER LOUVERED W/CENTER RAIL SMOOTH
LVSH16X72FNB	57	SHUTTER LOUVERED SMOOTH
LVSH16X72FNCR	56	SHUTTER LOUVERED W/CENTER RAIL SMOOTH
LVSH18X54FNB	57	SHUTTER LOUVERED SMOOTH
LVSH18X60FNB	57	SHUTTER LOUVERED SMOOTH
LVSH18X60FNCR	56	SHUTTER LOUVERED W/CENTER RAIL SMOOTH
LVSH18X66FNCR	56	SHUTTER LOUVERED W/CENTER RAIL SMOOTH
LVSH18X72FNB	57	SHUTTER LOUVERED SMOOTH
LVSH18X72FNCR	56	SHUTTER LOUVERED W/CENTER RAIL SMOOTH
LVSH24X60FNB	57	SHUTTER LOUVERED SMOOTH
LVSH24X60FNCR	56	SHUTTER LOUVERED W/CENTER RAIL SMOOTH
LVSH24X72FNB	57	SHUTTER LOUVERED SMOOTH
LVSH24X72FNCR	56	SHUTTER LOUVERED W/CENTER RAIL SMOOTH
<b>M</b>		
MLD205-12	112	MOULDING W&D CASING SMOOTH
MLD207-16	112	MOULDING W&D CASING FLUTED SMOOTH
MLD208-16	112	MOULDING W&D CASING FLUTED SMOOTH
MLD214-12	104	MOULDING W&D CASING SMOOTH
MLD215-12	117	MOULDING W&D CASING SMOOTH
MLD220-12	109	MOULDING W&D CASING SMOOTH

PART NUMBER	PAGE	DESCRIPTION
MLD220-16	109	MOULDING W&D CASING SMOOTH
MLD221-16	109	MOULDING W&D CASING SMOOTH
MLD221-8	109	MOULDING W&D CASING SMOOTH
MLD224-12	108	MOULDING W&D CASING SMOOTH
MLD226-10	101	MOULDING W&D CASING SMOOTH
MLD226-12	101	MOULDING W&D CASING SMOOTH
MLD226-16	101	MOULDING W&D CASING SMOOTH
MLD227-16	111	MOULDING W&D CASING SMOOTH
MLD230-16	108	MOULDING W&D CASING SMOOTH
MLD231-12	104	MOULDING W&D CASING SMOOTH
MLD232-16	109	MOULDING W&D CASING SMOOTH
MLD234-16	104	MOULDING W&D CASING SMOOTH
MLD236-16	109	MOULDING W&D CASING SMOOTH
MLD237-16	108	MOULDING W&D CASING SMOOTH
MLD240-8	101	MOULDING CORNICE SMOOTH
MLD245-12	111	MOULDING W&D CASING SMOOTH
MLD246-16	111	MOULDING FASCIA SMOOTH
MLD247-16	111	MOULDING BASE TRIM SMOOTH
MLD250-8	108	MOULDING W&D CASING SMOOTH
MLD250-12	108	MOULDING W&D CASING SMOOTH
MLD253-16	93	MOULDING CROWN FASCIA SMOOTH
MLD303-5	113	MOULDING DENTIL SMOOTH
MLD304-8	113	MOULDING DENTIL SMOOTH
MLD310-12	114	MOULDING DENTIL SMOOTH
MLD310-16	114	MOULDING DENTIL SMOOTH
MLD310-8	114	MOULDING DENTIL SMOOTH
MLD311-16	102	MOULDING CORNICE SMOOTH
MLD313-8	113	MOULDING DENTIL SMOOTH
MLD320-12	114	MOULDING DENTIL SMOOTH
MLD320-16	114	MOULDING DENTIL SMOOTH
MLD320-8	114	MOULDING DENTIL SMOOTH
MLD330-12	115	MOULDING DENTIL SMOOTH
MLD331-16	115	MOULDING DENTIL SMOOTH
MLD332-8	114	MOULDING DENTIL SMOOTH
MLD333-12	115	MOULDING DENTIL SMOOTH
MLD335-12	114	MOULDING DENTIL SMOOTH
MLD336-16	98	MOULDING DENTIL SMOOTH
MLD350-8	114	MOULDING DENTIL SMOOTH
MLD351-8	113	MOULDING DENTIL SMOOTH
MLD352-8	114	MOULDING DENTIL SMOOTH
MLD353-8	114	MOULDING DENTIL SMOOTH
MLD354-12	113	MOULDING DENTIL SMOOTH
MLD355-8	113	MOULDING DENTIL SMOOTH
MLD357-8	21,113	MOULDING, DENTIL TRIM DISTINCTION CROSSHEAD 6"
MLD358-8	21,113	MOULDING, DENTIL TRIM DISTINCTION CROSSHEAD 9"
MLD360-8	114	MOULDING DENTIL SMOOTH

PART NUMBER	PAGE	DESCRIPTION
MLD362-16	98	MOULDING DENTIL SMOOTH
MLD365-16	98	MOULDING DENTIL SMOOTH
MLD370-8	115	MOULDING DENTIL SMOOTH
MLD371-16	94	MOULDING CROWN FASCIA SMOOTH
MLD372-14	96	MOULDING CROWN FASCIA SMOOTH
MLD404-16	98	MOULDING CROWN SMOOTH
MLD406-16	98	MOULDING CROWN SMOOTH
MLD410-12	98	MOULDING CROWN SMOOTH
MLD411-16	98	MOULDING CROWN SMOOTH
MLD412-16	99	MOULDING CROWN SMOOTH
MLD413-12	99	MOULDING CROWN SMOOTH
MLD419-12	99	MOULDING CROWN SMOOTH
MLD421-12	99	MOULDING CROWN SMOOTH
MLD425-12	100	MOULDING CROWN SMOOTH
MLD430-12	98	MOULDING CROWN SMOOTH
MLD434-16	115	MOULDING DENTIL SMOOTH
MLD435-16	99	MOULDING CROWN SMOOTH
MLD440-12	98	MOULDING CROWN SMOOTH
MLD449-16	93	MOULDING CROWN SMOOTH
MLD450-16	94	MOULDING CROWN SMOOTH
MLD451-16	90	MOULDING CROWN SMOOTH
MLD452-12	90	MOULDING CROWN SMOOTH
MLD453-16	92	MOULDING CROWN SMOOTH
MLD454-12	90	MOULDING CROWN SMOOTH
MLD456-16	90	MOULDING CROWN SMOOTH
MLD457-12	93	MOULDING CROWN SMOOTH
MLD460-12	91	MOULDING CROWN SMOOTH
MLD461-8	99	MOULDING CROWN SMOOTH
MLD467-16	91	MOULDING CROWN SMOOTH
MLD471-12	91	MOULDING CROWN SMOOTH
MLD472-12	103	MOULDING CROWN SMOOTH
MLD480-12	93	MOULDING CROWN SMOOTH
MLD481-12	97	MOULDING CROWN SMOOTH
MLD490-12	100	MOULDING CROWN SMOOTH
MLD493-12	100	MOULDING CROWN SMOOTH
MLD505-8	102	MOULDING FASCIA SMOOTH
MLD506-16	103	MOULDING FASCIA SMOOTH
MLD508-12	102	MOULDING FASCIA SMOOTH
MLD509-16	101	MOULDING CORNICE SMOOTH
MLD510-12	101	MOULDING CORNICE SMOOTH
MLD511-12	101	MOULDING CORNICE SMOOTH
MLD512-16	102	MOULDING CORNICE SMOOTH
MLD513-16	101	MOULDING FASCIA SMOOTH
MLD520-16	102	MOULDING CORNICE SMOOTH
MLD521-8	102	MOULDING FASCIA SMOOTH
MLD522-16	111	MOULDING FASCIA SMOOTH

PART NUMBER	PAGE	DESCRIPTION
MLD523-16	101	MOULDING FASCIA SMOOTH
MLD524-16	96	MOULDING CROWN FASCIA SMOOTH
MLD527-16	102	MOULDING CORNICE SMOOTH
MLD528-12	97	MOULDING CROWN SMOOTH
MLD530-8	111	MOULDING FASCIA SMOOTH
MLD531-8	111	MOULDING FASCIA SMOOTH
MLD533-12	103	MOULDING FASCIA SMOOTH
MLD534-12	103	MOULDING CORNICE SMOOTH
MLD535-16	94	MOULDING CROWN SMOOTH
MLD536-12	96	MOULDING CROWN FASCIA SMOOTH
MLD539-16	96	MOULDING CROWN FASCIA SMOOTH
MLD543-12	103	MOULDING FASCIA SMOOTH
MLD545-12	102	MOULDING CORNICE SMOOTH
MLD547-16	102	MOULDING CORNICE SMOOTH
MLD548-16	101	MOULDING FASCIA SMOOTH
MLD552-12	90	MOULDING CROWN FASCIA SMOOTH
MLD555-12	94	MOULDING CROWN SMOOTH
MLD556-16	96	MOULDING CROWN FASCIA SMOOTH
MLD562-8	100	MOULDING CROWN SMOOTH
MLD569-12	93	MOULDING CROWN FASCIA SMOOTH
MLD570-12	92	MOULDING CROWN FASCIA SMOOTH
MLD572-16	90	MOULDING CROWN SMOOTH
MLD758-12	21,116	MOULDING, BOTTOM TRIM DISTINCTION CROSSHEAD 9"
MLD580-12	96	MOULDING CROWN FASCIA SMOOTH
MLD582-12	93	MOULDING CROWN SMOOTH
MLD583-16	93	MOULDING COVE SMOOTH
MLD584-16	91	MOULDING COVE SMOOTH
MLD585-12	97	MOULDING CROWN FASCIA SMOOTH
MLD586-16	97	MOULDING CROWN FASCIA SMOOTH
MLD587-16	92	MOULDING CROWN FASCIA SMOOTH
MLD588-16	94	MOULDING COVE SMOOTH
MLD589-16	92	MOULDING COVE SMOOTH
MLD590-16	92	MOULDING COVE SMOOTH
MLD591-16	94	MOULDING COVE SMOOTH
MLD592-16	90	MOULDING COVE SMOOTH
MLD593-16	90	MOULDING COVE SMOOTH
MLD600-10	100	MOULDING FASCIA SMOOTH
MLD601-12	105	MOULDING OGEE SMOOTH
MLD602-8	105	MOULDING OGEE CROSSHEAD TRIM STRIP SMOOTH
MLD603-8	116	MOULDING QUARTER ROUND SMOOTH
MLD605-12	117	MOULDING HALF ROUND SMOOTH
MLD606-12	92	MOULDING COVE SMOOTH
MLD607-8	116	MOULDING CORNER STRIP SMOOTH
MLD610-8	106	MOULDING CHAIR RAIL SMOOTH
MLD611-12	106	MOULDING CHAIR RAIL SMOOTH

PART NUMBER	PAGE	DESCRIPTION
MLD612-12	105	MOULDING CHAIR RAIL SMOOTH
MLD613-12	106	MOULDING BED MOULDING SMOOTH
MLD614-16	106	MOULDING CHAIR RAIL SMOOTH
MLD618-16	105	MOULDING BASE CAP SMOOTH
MLD621-16	108	MOULDING SHINGLE SMOOTH
MLD625-16	106	MOULDING STEP SMOOTH
MLD626-8	105	MOULDING BED MOULDING SMOOTH
MLD627-16	105	MOULDING CHAIR RAIL SMOOTH
MLD628-8	116	MOULDING COVE SMOOTH
MLD629-10	106	MOULDING BED MOULDING SMOOTH
MLD631-16	106	MOULDING CHAIR RAIL SMOOTH
MLD633-8	105	MOULDING OGEE SMOOTH
MLD634-16	105	MOULDING OGEE SMOOTH
MLD635-12	94	MOULDING COVE SMOOTH
MLD637-16	104	MOULDING ASTRAGAL/MULLION SMOOTH
MLD639-16	109	MOULDING FASCIA SMOOTH
MLD640-8	100	MOULDING FASCIA SMOOTH
MLD641-16	108	MOULDING CORNICE SMOOTH
MLD642-12	96	MOULDING CROWN SMOOTH
MLD644-16	111	MOULDING FASCIA SMOOTH
MLD649-16	106	MOULDING BED MOULDING SMOOTH
MLD660-10	116	MOULDING COVE SMOOTH
MLD705-16	109	MOULDING FLAT TRIM PROFILES COVE SMOOTH
MLD706-16	106	MOULDING BASE TRIM SMOOTH
MLD710-10	104	MOULDING SILL SMOOTH
MLD715-16	108	MOULDING FLAT TRIM PROFILES BEADED SMOOTH
MLD716-12	21,116	MOULDING, BOTTOM TRIM DISTINCTION CROSSHEAD 6"
MLD730-8	116	MOULDING OGEE SMOOTH
MLD732-12	100	MOULDING CROWN FASCIA SMOOTH
MLD734-12	96	MOULDING COVE SMOOTH
MLD735-16	109	MOULDING FLAT TRIM PROFILES BEADED SMOOTH
MLD758-12	21,116	MOULDING, BOTTOM TRIM DISTINCTION CROSSHEAD 9"
MLD1001-12	93	MOULDING CROWN SMOOTH
MLD1002-12	93	MOULDING CROWN SMOOTH
MLD1019-12	108	MOULDING BASE TRIM SMOOTH
MLD1020-12	108	MOULDING BASE TRIM SMOOTH
MLD1037-12	92	MOULDING CROWN SMOOTH
MLDWM180-8	87	BRICKMOULD SMOOTH
MLDWM180-16	87	BRICKMOULD SMOOTH
MLDWM181-16	87	BRICKMOULD SMOOTH
MLDWM182-12	87	BRICKMOULD SMOOTH
N		
NP6X48	248	NEWEL POST PLAIN SMOOTH
NP8X48	248	NEWEL POST PLAIN SMOOTH
NP8X48ST	257	NEWEL POST, STONE TEXTURE

PART NUMBER	PAGE	DESCRIPTION
NP10X48	248	NEWEL POST DECO EDGE SMOOTH
NP12X48	249	NEWEL POST PLAIN SMOOTH
NPCP8X48	248	CORNER PANEL NEWEL POST SMOOTH
NPCP13X48	248	CORNER PANEL NEWEL POST SMOOTH
NPK10	249	NEWEL POST INSTALL KIT
NPK12	249	NEWEL POST INSTALL KIT SMOOTH
NPK13	249	NEWEL POST INSTALL KIT SMOOTH
NPK400	249	NEWEL POST INSTALL KIT SMOOTH
NPK600	249	NEWEL POST INSTALL KIT SMOOTH
NPSP8X48	249	STRAIGHT PANEL NEWEL POST SMOOTH
NPSP13X48	249	STRAIGHT PANEL NEWEL POST SMOOTH
<b>O</b>		
OLV18	201	OCTAGON LOUVER DECO SMOOTH
OLV22	201	OCTAGON LOUVER DECO SMOOTH
OLV24	201	OCTAGON LOUVER DECO SMOOTH
OLV28	201	OCTAGON LOUVER DECO SMOOTH
OV24X36X4F	53	TRIM OVAL FLAT SMOOTH
OV24X36X4M	53	TRIM OVAL DECORATIVE SMOOTH
OVL28X35K215V	199	LOUVER DECO OVAL VRTCL W/ DC TRIM & KEY SMOOTH
OVL35X28K215	199	LOUVER DECO OVAL HORZ W/ DC TRIM & KEY SMOOTH
OVLV18X24V	198	OVAL VERTICAL LOUVER DECO SMOOTH
OVLV20X29VTK	199	LOUVER DECO OVAL VRTCL W/ FL TRIM & KEY SMOOTH
OVLV25X37V	198	OVAL VERTICAL LOUVER DECO SMOOTH
OVLV29X20TK	199	LOUVER DECO OVAL HORZ W/TRIM & KEY SMOOTH
<b>P</b>		
PB2.5X2.5	117	PLINTH BLOCK ROSETTE SMOOTH
PB3X3	117	PLINTH BLOCK ROSETTE SMOOTH
PB3.5X3.5	117	PLINTH BLOCK ROSETTE SMOOTH
PB3.875X3.875	117	PLINTH BLOCK ROSETTE SMOOTH
PB4X4	117	PLINTH BLOCK ROSETTE SMOOTH
PB5X5	117	PLINTH BLOCK ROSETTE SMOOTH
PB6X6	117	PLINTH BLOCK ROSETTE SMOOTH
PCP56	40	PEDIMENT PEAKED CAP SMOOTH
PCP667	40	PEDIMENT PEAKED CAP SMOOTH
PHFR5X11	183	FINIAL FULL RND PINEAPPLE SMOOTH
PHFR6X14	183	FINIAL FULL RND PINEAPPLE SMOOTH
PIL3X81	47	PILASTER FLUTED MLD PLTH SMOOTH
PIL3X108	48	PILASTER FLUTED ADJ PLTH SMOOTH
PIL3X90E	48	PILASTER FLUTED ECO MLD PLTH SMOOTH
PIL4X83	47	PILASTER FLUTED MLD PLTH SMOOTH
PIL4X86	47	PILASTER FLUTED MLD PLTH SMOOTH
PIL4X90	47	PILASTER FLUTED MLD PLTH SMOOTH
PIL4X108	48	PILASTER FLUTED ADJ PLTH SMOOTH
PIL5X82	47	PILASTER FLUTED MLD PLTH SMOOTH
PIL5X90	47	PILASTER FLUTED MLD PLTH SMOOTH

PART NUMBER	PAGE	DESCRIPTION
PIL5X90DP	46	PILASTER DOUBLE PANEL MLD PLTH SMOOTH
PIL5X90E	48	PILASTER FLUTED ECO MLD PLTH SMOOTH
PIL5X90P	45	PILASTER PLAIN MLD PLTH SMOOTH
PIL5X108	48	PILASTER FLUTED ADJ PLTH SMOOTH
PIL5X108P	46	PILASTER PLAIN ADJ PLTH SMOOTH
PIL5X120E	49	PILASTER FLUTED ECO ADJ PLTH SMOOTH
PIL6X90	47	PILASTER FLUTED MLD PLTH SMOOTH
PIL6X90P	45	PILASTER PLAIN MLD PLTH SMOOTH
PIL6X108	48	PILASTER FLUTED ADJ PLTH SMOOTH
PIL6X120P	46	PILASTER PLAIN ADJ PLTH SMOOTH
PIL6X144	48	PILASTER FLUTED ADJ PLTH SMOOTH
PIL7X90	47	PILASTER FLUTED MLD PLTH SMOOTH
PIL7X90DP	46	PILASTER DOUBLE PANEL MLD PLTH SMOOTH
PIL7X90DPE	47	PILASTER DOUBLE PANEL ECO MLD PLTH SMOOTH
PIL7X90E	48	PILASTER FLUTED ECO MLD PLTH SMOOTH
PIL7X90P	45	PILASTER PLAIN MLD PLTH SMOOTH
PIL7X90PE	45	PILASTER DOUBLE PANEL ECO MLD PLTH SMOOTH
PIL7X102	48	PILASTER FLUTED ADJ PLTH SMOOTH
PIL7X108	48	PILASTER FLUTED ADJ PLTH SMOOTH
PIL7X108P	46	PILASTER PLAIN ADJ PLTH SMOOTH
PIL7X120E	49	PILASTER FLUTED ECO ADJ PLTH SMOOTH
PIL7X120P	46	PILASTER PLAIN ADJ PLTH SMOOTH
PIL7X144	48	PILASTER FLUTED ADJ PLTH SMOOTH
PIL8X90	48	PILASTER FLUTED ADJ PLTH SMOOTH
PIL8X90P	45	PILASTER PLAIN MLD PLTH SMOOTH
PIL8X108	48	PILASTER FLUTED ADJ PLTH SMOOTH
PIL8X108P	46	PILASTER PLAIN ADJ PLTH SMOOTH
PIL8X144	48	PILASTER FLUTED ADJ PLTH SMOOTH
PIL9X90	47	PILASTER FLUTED MLD PLTH SMOOTH
PIL9X90DP	46	PILASTER DOUBLE PANEL MLD PLTH SMOOTH
PIL9X90E	48	PILASTER FLUTED ECO MLD PLTH SMOOTH
PIL9X90P	45	PILASTER PLAIN MLD PLTH SMOOTH
PIL9X100DP	46	PILASTER DOUBLE PANEL MLD PLTH SMOOTH
PIL9X102	48	PILASTER FLUTED ADJ PLTH SMOOTH
PIL9X108	48	PILASTER FLUTED ADJ PLTH SMOOTH
PIL9X108P	46	PILASTER PLAIN ADJ PLTH SMOOTH
PIL9X120P	46	PILASTER PLAIN ADJ PLTH SMOOTH
PIL9X144	48	PILASTER FLUTED ADJ PLTH SMOOTH
PIL10X96A	49	PILASTER ARCH PROF SMOOTH
PIL10X96HC	49	PILASTER HALF RND ADJ CLM SMOOTH
PIL10X120P	46	PILASTER PLAIN ADJ PLTH SMOOTH
PIL10X192A	49	PILASTER ARCH PROF SMOOTH
PIL11X90	47	PILASTER FLUTED MLD PLTH SMOOTH
PIL11X90DP	46	PILASTER DOUBLE PANEL MLD PLTH SMOOTH
PIL11X90P	45	PILASTER PLAIN MLD PLTH SMOOTH

PART NUMBER	PAGE	DESCRIPTION
PIL11X96P	46	PILASTER PLAIN ADJ PLTH SMOOTH
PIL11X108	48	PILASTER FLUTED ADJ PLTH SMOOTH
PIL11X108DP	46	PILASTER DOUBLE PANEL MLD PLTH SMOOTH
PIL11X108P	46	PILASTER PLAIN ADJ PLTH SMOOTH
PIL11X109P	46	PILASTER PLAIN ADJ PLTH SMOOTH
PIL11X120	48	PILASTER FLUTED ADJ PLTH SMOOTH
PIL11X120P	46	PILASTER PLAIN ADJ PLTH SMOOTH
PIL11X144	48	PILASTER FLUTED ADJ PLTH SMOOTH
PLV18X24-8	189	PEAKED LOUVER DECO SMOOTH
PLV18X36-10	189	PEAKED LOUVER DECO SMOOTH
PLV24X30-10	189	PEAKED LOUVER DECO SMOOTH
PLV24X36-10	189	PEAKED LOUVER DECO SMOOTH
PLV24X36-12	189	PEAKED LOUVER DECO SMOOTH
PP5X102	253	PORCH POST COLONIAL SMOOTH
PP6X108	253	PORCH POST COLONIAL SMOOTH
PP6X120	253	PORCH POST COLONIAL SMOOTH
PP6X96	253	PORCH POST COLONIAL SMOOTH
PP8X120A	253	PORCH POST COLONIAL SMOOTH
PPSQKIT6X108S	255	COLUMN, TIMBER TEXTURE
PRS48X8	252	PORCH SPANDREL SMOOTH
PRS96X8	252	PORCH SPANDREL SMOOTH
PST6X6FP	251	NEWEL POST FANCY PEAKED POST CAP SMOOTH
PST7X7F	250	NEWEL POST FLAT POST CAP SMOOTH
PST8X8FP	251	NEWEL POST FANCY PEAKED POST CAP SMOOTH
PST9X9FP	251	NEWEL POST FANCY PEAKED POST CAP SMOOTH
PST10X10F	250	NEWEL POST FLAT POST CAP SMOOTH
PST10X10PST	257	NEWEL POST TOP, STONE TEXTURE
PST11X11FP	251	NEWEL POST FANCY PEAKED CAP SMOOTH
PST13X13F	250	NEWEL POST FLAT POST CAP SMOOTH
PST13X13FP	251	NEWEL POST FANCY PEAKED CAP SMOOTH
PST14X14F	250	NEWEL POST FLAT POST CAP SMOOTH
<b>R</b>		
RHP56	43	PEDIMENT RAMS HEAD SMOOTH
RHP86	43	PEDIMENT RAMS HEAD SMOOTH
RHP667	43	PEDIMENT RAMS HEAD SMOOTH
RHP6100	43	PEDIMENT RAMS HEAD SMOOTH
RLV12	196	LOUVER DECO ROUND SMOOTH
RLV16	196	LOUVER DECO ROUND SMOOTH
RLV16MTK	197	LOUVER DECO ROUND W/ DC TRIM & KEY SMOOTH
RLV18	196	LOUVER DECO ROUND SMOOTH
RLV18MTK	197	LOUVER DECO ROUND W/ DC TRIM & KEY SMOOTH
RLV18X4F	196	TRIM ROUND SMOOTH
RLV22	196	LOUVER DECO ROUND SMOOTH
RLV24	196	LOUVER DECO ROUND SMOOTH
RLV24-4FTK	197	LOUVER DECO ROUND W/ FL TRIM & KEY SMOOTH

PART NUMBER	PAGE	DESCRIPTION
RLV24-6TK	197	LOUVER FUNC ROUND W/ FL TRIM & FLAT KEY SMOOTH
RLV24MTK	197	LOUVER DECO ROUND W/ DC TRIM & KEY SMOOTH
RLV24TK	198	LOUVER DECO ROUND W/ FL TRIM & KEY SMOOTH
RLV24X4F	196	TRIM ROUND SMOOTH
RLV28	196	LOUVER DECO ROUND SMOOTH
RLV28X4F	196	TRIM ROUND SMOOTH
RLV30	196	LOUVER DECO ROUND SMOOTH
RLV30-6TK	197	LOUVER DECO ROUND W/ FL TRIM & KEY SMOOTH
RLV30MTK	197	LOUVER DECO ROUND W/ DC TRIM & KEY SMOOTH
RLV30TK	198	LOUVER DECO ROUND W/ FL TRIM & KEY SMOOTH
RLV32-2F	196	LOUVER DECO ROUND W/ FL TRIM SMOOTH
RLV32MTK	197	LOUVER DECO ROUND W/ DC TRIM & KEY SMOOTH
RLV32TK	198	LOUVER DECO ROUND W/ FL TRIM & KEY SMOOTH
RLV36	196	LOUVER DECO ROUND SMOOTH
RLV36TK	198	LOUVER DECO ROUND W/ FL TRIM & KEY SMOOTH
RLV40MTK	197	LOUVER DECO ROUND W/ DC TRIM & KEY SMOOTH
RLV42	196	LOUVER DECO ROUND SMOOTH
RLV48	196	LOUVER DECO ROUND SMOOTH
RSB4X4X6	246	BAULSTER RAIL SUPPORT BLOCK SMOOTH
<b>S</b>		
S4X21	182	SPIRE SMOOTH
S6X32	182	SPIRE SMOOTH
S8X56	182	SPIRE SMOOTH
SH16X48DP	56	SHUTTER RAISED PANEL DOUBLE SMOOTH
SH16X54DP	56	SHUTTER RAISED PANEL DOUBLE SMOOTH
SH16X60DP	56	SHUTTER RAISED PANEL DOUBLE SMOOTH
SH16X65DP	56	SHUTTER RAISED PANEL DOUBLE SMOOTH
SH16X72DP	56	SHUTTER RAISED PANEL DOUBLE SMOOTH
SH18X53DP	56	SHUTTER RAISED PANEL DOUBLE SMOOTH
SH18X59DP	56	SHUTTER RAISED PANEL DOUBLE SMOOTH
SH18X66DP	56	SHUTTER RAISED PANEL DOUBLE SMOOTH
SH18X72DP	56	SHUTTER RAISED PANEL DOUBLE SMOOTH
<b>SHAKER SHUTTER 12"</b>		
SH2FP12X__	61	SHAKER SHUTTER
<b>SHAKER SHUTTER 16"</b>		
SH2FP16X__	61	SHAKER SHUTTER
<b>SHAKER SHUTTER 18"</b>		
SH2FP18X__	61	SHAKER SHUTTER
<b>SHAKER SHUTTER 24"</b>		
SH2FP24X__	61	SHAKER SHUTTER
<b>PLANK, 2 PLANK, 3 BATTEN 12"</b>		
SH2P3B12X24RS	74	SHUTTER 2 PLANK 3 BATTEN, ROUGH SAWN WOODGRAIN
SH2P3B12X36RS	74	SHUTTER 2 PLANK 3 BATTEN, ROUGH SAWN WOODGRAIN
SH2P3B12X48RS	74	SHUTTER 2 PLANK 3 BATTEN, ROUGH SAWN WOODGRAIN
SH2P3B12X60RS	74	SHUTTER 2 PLANK 3 BATTEN, ROUGH SAWN WOODGRAIN

PART NUMBER	PAGE	DESCRIPTION
SH2P3B12X72RS	74	SHUTTER 2 PLANK 3 BATTEN, ROUGH SAWN WOODGRAIN
SH2P3B12X84RS	74	SHUTTER 2 PLANK 3 BATTEN, ROUGH SAWN WOODGRAIN
SH2P3B12X96RS	74	SHUTTER 2 PLANK 3 BATTEN, ROUGH SAWN WOODGRAIN
SH2P3B12X108RS	74	SHUTTER 2 PLANK 3 BATTEN, ROUGH SAWN WOODGRAIN
SH2P3B12X120RS	74	SHUTTER 2 PLANK 3 BATTEN, ROUGH SAWN WOODGRAIN
<b>B&amp;B 2 BOARD, 3 BATTEN 12"</b>		
SH2P3BC12X24RS	66	SHUTTER 2 BOARD AND 3 BATTEN, ROUGH SAWN WOODGRAIN
SH2P3BC12X36RS	66	SHUTTER 2 BOARD AND 3 BATTEN, ROUGH SAWN WOODGRAIN
SH2P3BC12X48RS	66	SHUTTER 2 BOARD AND 3 BATTEN, ROUGH SAWN WOODGRAIN
SH2P3BC12X60RS	66	SHUTTER 2 BOARD AND 3 BATTEN, ROUGH SAWN WOODGRAIN
SH2P3BC12X72RS	66	SHUTTER 2 BOARD AND 3 BATTEN, ROUGH SAWN WOODGRAIN
SH2P3BC12X84RS	66	SHUTTER 2 BOARD AND 3 BATTEN, ROUGH SAWN WOODGRAIN
SH2P3BC12X96RS	66	SHUTTER 2 BOARD AND 3 BATTEN, ROUGH SAWN WOODGRAIN
SH2P3BC12X108RS	66	SHUTTER 2 BOARD AND 3 BATTEN, ROUGH SAWN WOODGRAIN
SH2P3BC12X120RS	66	SHUTTER 2 BOARD AND 3 BATTEN, ROUGH SAWN WOODGRAIN
<b>B&amp;B 2 BOARD, 2 BATTEN 12"</b>		
SH2PC12X24RS	66	SHUTTER 2 BOARD AND BATTEN, ROUGH SAWN WOODGRAIN
SH2PC12X36RS	66	SHUTTER 2 BOARD AND BATTEN, ROUGH SAWN WOODGRAIN
SH2PC12X48RS	66	SHUTTER 2 BOARD AND BATTEN, ROUGH SAWN WOODGRAIN
SH2PC12X60RS	66	SHUTTER 2 BOARD AND BATTEN, ROUGH SAWN WOODGRAIN
SH2PC12X72RS	66	SHUTTER 2 BOARD AND BATTEN, ROUGH SAWN WOODGRAIN
SH2PC12X84RS	66	SHUTTER 2 BOARD AND BATTEN, ROUGH SAWN WOODGRAIN
SH2PC12X96RS	66	SHUTTER 2 BOARD AND BATTEN, ROUGH SAWN WOODGRAIN
SH2PC12X108RS	66	SHUTTER 2 BOARD AND BATTEN, ROUGH SAWN WOODGRAIN
SH2PC12X120RS	66	SHUTTER 2 BOARD AND BATTEN, ROUGH SAWN WOODGRAIN
<b>PLANK, 2 PLANK, DIAMOND 12"</b>		
SH2PD12X24RS	78	SHUTTER 2 PLANK W/DIAMOND, ROUGH SAWN WOODGRAIN
SH2PD12X36RS	78	SHUTTER 2 PLANK W/DIAMOND, ROUGH SAWN WOODGRAIN
SH2PD12X48RS	78	SHUTTER 2 PLANK W/DIAMOND, ROUGH SAWN WOODGRAIN
SH2PD12X60RS	78	SHUTTER 2 PLANK W/DIAMOND, ROUGH SAWN WOODGRAIN
SH2PD12X72RS	78	SHUTTER 2 PLANK W/DIAMOND, ROUGH SAWN WOODGRAIN
SH2PD12X84RS	78	SHUTTER 2 PLANK W/DIAMOND, ROUGH SAWN WOODGRAIN
SH2PD12X96RS	78	SHUTTER 2 PLANK W/DIAMOND, ROUGH SAWN WOODGRAIN
SH2PD12X108RS	78	SHUTTER 2 PLANK W/DIAMOND, ROUGH SAWN WOODGRAIN
SH2PD12X120RS	78	SHUTTER 2 PLANK W/DIAMOND, ROUGH SAWN WOODGRAIN
<b>B&amp;B 2 BOARD, END BATTEN 12"</b>		
SH2PEBC12X24RS	66	SHUTTER 2 BOARD AND END BATTEN, ROUGH SAWN WOODGRAIN
SH2PEBC12X36RS	66	SHUTTER 2 BOARD AND END BATTEN, ROUGH SAWN WOODGRAIN
SH2PEBC12X48RS	66	SHUTTER 2 BOARD AND END BATTEN, ROUGH SAWN WOODGRAIN
SH2PEBC12X60RS	66	SHUTTER 2 BOARD AND END BATTEN, ROUGH SAWN WOODGRAIN
SH2PEBC12X72RS	66	SHUTTER 2 BOARD AND END BATTEN, ROUGH SAWN WOODGRAIN
SH2PEBC12X84RS	66	SHUTTER 2 BOARD AND END BATTEN, ROUGH SAWN WOODGRAIN
SH2PEBC12X96RS	66	SHUTTER 2 BOARD AND END BATTEN, ROUGH SAWN WOODGRAIN
SH2PEBC12X108RS	66	SHUTTER 2 BOARD AND END BATTEN, ROUGH SAWN WOODGRAIN
SH2PEBC12X120RS	66	SHUTTER 2 BOARD AND END BATTEN, ROUGH SAWN WOODGRAIN

PART NUMBER	PAGE	DESCRIPTION
<b>ELLIPTICAL SHUTTER, BOARD AND BATTEN</b>		
SH2PE12X_X_RS	77	ELLIPTICAL SHUTTER 2 BOARD, ROUGH SAWN
SH3PE18X_X_RS	77	ELLIPTICAL SHUTTER 3 BOARD, ROUGH SAWN
SH4PE24X_X_RS	77	ELLIPTICAL SHUTTER 4 BOARD, ROUGH SAWN
<b>ELLIPTICAL SHUTTER, PLANK</b>		
SH2PEHLR12X_X_RS	76	ELLIPTICAL SHUTTER 2 PLANK, ROUGH SAWN
SH3PEHLR14X_X_RS	76	ELLIPTICAL SHUTTER 3 PLANK, ROUGH SAWN
SH3PEHLR18X_X_RS	76	ELLIPTICAL SHUTTER 3 PLANK, ROUGH SAWN
SH4PEHLR24X_X_RS	76	ELLIPTICAL SHUTTER 4 PLANK, ROUGH SAWN
<b>B&amp;B 2 BOARD, QUARTER ROUND 2 BATTEN 12"</b>		
SH2PHLR12X24RS	67	SHUTTER 2 ARCH TOP BOARD AND BATTEN, ROUGH SAWN
SH2PHLR12X36RS	67	SHUTTER 2 ARCH TOP BOARD AND BATTEN, ROUGH SAWN
SH2PHLR12X48RS	67	SHUTTER 2 ARCH TOP BOARD AND BATTEN, ROUGH SAWN
SH2PHLR12X60RS	67	SHUTTER 2 ARCH TOP BOARD AND BATTEN, ROUGH SAWN
SH2PHLR12X72RS	67	SHUTTER 2 ARCH TOP BOARD AND BATTEN, ROUGH SAWN
SH2PHLR12X84RS	67	SHUTTER 2 ARCH TOP BOARD AND BATTEN, ROUGH SAWN
SH2PHLR12X96RS	67	SHUTTER 2 ARCH TOP BOARD AND BATTEN, ROUGH SAWN
SH2PHLR12X108RS	67	SHUTTER 2 ARCH TOP BOARD AND BATTEN, ROUGH SAWN
SH2PHLR12X120RS	67	SHUTTER 2 ARCH TOP BOARD AND BATTEN, ROUGH SAWN
<b>PLANK, 2 PLANK 2 BATTEN 12"</b>		
SH2P012X24RS	74	SHUTTER 2 PLANK, ROUGH SAWN WOODGRAIN
SH2P012X36RS	74	SHUTTER 2 PLANK, ROUGH SAWN WOODGRAIN
SH2P012X48RS	74	SHUTTER 2 PLANK, ROUGH SAWN WOODGRAIN
SH2P012X60RS	74	SHUTTER 2 PLANK, ROUGH SAWN WOODGRAIN
SH2P012X72RS	74	SHUTTER 2 PLANK, ROUGH SAWN WOODGRAIN
SH2P012X84RS	74	SHUTTER 2 PLANK, ROUGH SAWN WOODGRAIN
SH2P012X96RS	74	SHUTTER 2 PLANK, ROUGH SAWN WOODGRAIN
SH2P012X108RS	74	SHUTTER 2 PLANK, ROUGH SAWN WOODGRAIN
SH2P012X120RS	74	SHUTTER 2 PLANK, ROUGH SAWN WOODGRAIN
<b>PLANK, 2 PLANK Z BATTEN 12"</b>		
SH2PZ12X24RS	74	SHUTTER 2 PLANK Z-BATTEN, ROUGH SAWN WOODGRAIN
SH2PZ12X36RS	74	SHUTTER 2 PLANK Z-BATTEN, ROUGH SAWN WOODGRAIN
SH2PZ12X48RS	74	SHUTTER 2 PLANK Z-BATTEN, ROUGH SAWN WOODGRAIN
SH2PZ12X60RS	74	SHUTTER 2 PLANK Z-BATTEN, ROUGH SAWN WOODGRAIN
SH2PZ12X84RS	74	SHUTTER 2 PLANK Z-BATTEN, ROUGH SAWN WOODGRAIN
SH2PZ12X96RS	74	SHUTTER 2 PLANK Z-BATTEN, ROUGH SAWN WOODGRAIN
SH2PZ12X108RS	74	SHUTTER 2 PLANK Z-BATTEN, ROUGH SAWN WOODGRAIN
SH2PZ12X120RS	74	SHUTTER 2 PLANK Z-BATTEN, ROUGH SAWN WOODGRAIN
<b>B&amp;B 2 BOARD, Z BATTEN 12"</b>		
SH2PZC12X24RS	67	SHUTTER 2 BOARD AND Z-BATTEN, ROUGH SAWN WOODGRAIN
SH2PZC12X36RS	67	SHUTTER 2 BOARD AND Z-BATTEN, ROUGH SAWN WOODGRAIN
SH2PZC12X48RS	67	SHUTTER 2 BOARD AND Z-BATTEN, ROUGH SAWN WOODGRAIN
SH2PZC12X60RS	67	SHUTTER 2 BOARD AND Z-BATTEN, ROUGH SAWN WOODGRAIN
SH2PZC12X72RS	67	SHUTTER 2 BOARD AND Z-BATTEN, ROUGH SAWN
SH2PZC12X84RS	67	SHUTTER 2 BOARD AND Z-BATTEN, ROUGH SAWN WOODGRAIN

PART NUMBER	PAGE	DESCRIPTION
SH2PZC12X96RS	67	SHUTTER 2 BOARD AND Z-BATTEN, ROUGH SAWN WOODGRAIN
SH2PZC12X108RS	67	SHUTTER 2 BOARD AND Z-BATTEN, ROUGH SAWN WOODGRAIN
SH2PZC12X120RS	67	SHUTTER 2 BOARD AND Z-BATTEN, ROUGH SAWN WOODGRAIN
PLANK, 3 PLANK 3 BATTEN 18"		
SH3P3B18X24RS	74	SHUTTER 3 PLANK 3 BATTEN, ROUGH SAWN WOODGRAIN
SH3P3B18X36RS	74	SHUTTER 3 PLANK 3 BATTEN, ROUGH SAWN WOODGRAIN
SH3P3B18X48RS	74	SHUTTER 3 PLANK 3 BATTEN, ROUGH SAWN WOODGRAIN
SH3P3B18X60RS	74	SHUTTER 3 PLANK 3 BATTEN, ROUGH SAWN WOODGRAIN
SH3P3B18X72RS	74	SHUTTER 3 PLANK 3 BATTEN, ROUGH SAWN WOODGRAIN
SH3P3B18X84RS	74	SHUTTER 3 PLANK 3 BATTEN, ROUGH SAWN WOODGRAIN
SH3P3B18X96RS	74	SHUTTER 3 PLANK 3 BATTEN, ROUGH SAWN WOODGRAIN
SH3P3B18X108RS	74	SHUTTER 3 PLANK 3 BATTEN, ROUGH SAWN WOODGRAIN
SH3P3B18X120RS	74	SHUTTER 3 PLANK 3 BATTEN, ROUGH SAWN WOODGRAIN
B&B 3 BOARD, 3 BATTEN 14"		
SH3P3BC14X24RS	68	SHUTTER 3 BOARD 3 BATTEN, ROUGH SAWN WOODGRAIN
SH3P3BC14X36RS	68	SHUTTER 3 BOARD 3 BATTEN, ROUGH SAWN WOODGRAIN
SH3P3BC14X48RS	68	SHUTTER 3 BOARD 3 BATTEN, ROUGH SAWN WOODGRAIN
SH3P3BC14X60RS	68	SHUTTER 3 BOARD 3 BATTEN, ROUGH SAWN WOODGRAIN
SH3P3BC14X72RS	68	SHUTTER 3 BOARD 3 BATTEN, ROUGH SAWN WOODGRAIN
SH3P3BC14X84RS	68	SHUTTER 3 BOARD 3 BATTEN, ROUGH SAWN WOODGRAIN
SH3P3BC14X96RS	68	SHUTTER 3 BOARD 3 BATTEN, ROUGH SAWN WOODGRAIN
SH3P3BC14X108RS	68	SHUTTER 3 BOARD 3 BATTEN, ROUGH SAWN WOODGRAIN
SH3P3BC14X120RS	68	SHUTTER 3 BOARD 3 BATTEN, ROUGH SAWN WOODGRAIN
B&B 3 BOARD, 3 BATTEN 18"		
SH3P3BC18X24RS	70	SHUTTER 3 BOARD 3 BATTEN, ROUGH SAWN WOODGRAIN
SH3P3BC18X36RS	70	SHUTTER 3 BOARD 3 BATTEN, ROUGH SAWN WOODGRAIN
SH3P3BC18X48RS	70	SHUTTER 3 BOARD 3 BATTEN, ROUGH SAWN WOODGRAIN
SH3P3BC18X60RS	70	SHUTTER 3 BOARD 3 BATTEN, ROUGH SAWN WOODGRAIN
SH3P3BC18X72RS	70	SHUTTER 3 BOARD 3 BATTEN, ROUGH SAWN WOODGRAIN
SH3P3BC18X84RS	70	SHUTTER 3 BOARD 3 BATTEN, ROUGH SAWN WOODGRAIN
SH3P3BC18X96RS	70	SHUTTER 3 BOARD 3 BATTEN, ROUGH SAWN WOODGRAIN
SH3P3BC18X108RS	70	SHUTTER 3 BOARD 3 BATTEN, ROUGH SAWN WOODGRAIN
SH3P3BC18X120RS	70	SHUTTER 3 BOARD 3 BATTEN, ROUGH SAWN WOODGRAIN
PANEL SHUTTERS - WOODGRAIN		
SH3PB15X46S	79	SHUTTER, TIMBER TEXTURE, 3 PLANK W/BORDER
SH3PB18X40S	79	SHUTTER, TIMBER TEXTURE, 3 PLANK W/BORDER
SH3PB18X66S	79	SHUTTER, TIMBER TEXTURE, 3 PLANK
SH3PB24X54S	79	SHUTTER, TIMBER TEXTURE, 3 PLANK
B&B 3 BOARD, 2 BATTEN 14"		
SH3PC14X24RS	68	SHUTTER 3 BOARD 2 BATTEN, ROUGH SAWN WOODGRAIN
SH3PC14X48RS	68	SHUTTER 3 BOARD 2 BATTEN, ROUGH SAWN WOODGRAIN
SH3PC14X60RS	68	SHUTTER 3 BOARD 2 BATTEN, ROUGH SAWN WOODGRAIN
SH3PC14X72RS	68	SHUTTER 3 BOARD 2 BATTEN, ROUGH SAWN WOODGRAIN

PART NUMBER	PAGE	DESCRIPTION
SH3PC14X84RS	68	SHUTTER 3 BOARD 2 BATTEN, ROUGH SAWN WOODGRAIN
SH3PC14X96RS	68	SHUTTER 3 BOARD 2 BATTEN, ROUGH SAWN WOODGRAIN
SH3PC14X108RS	68	SHUTTER 3 BOARD 2 BATTEN, ROUGH SAWN WOODGRAIN
SH3PC14X120RS	68	SHUTTER 3 BOARD 2 BATTEN, ROUGH SAWN WOODGRAIN
B&B 3 BOARD, 2 BATTEN 18"		
SH3PC18X24RS	70	SHUTTER 3 BOARD AND BATTEN, ROUGH SAWN WOODGRAIN
SH3PC18X36RS	70	SHUTTER 3 BOARD AND BATTEN, ROUGH SAWN WOODGRAIN
SH3PC18X48RS	70	SHUTTER 3 BOARD AND BATTEN, ROUGH SAWN WOODGRAIN
SH3PC18X60RS	70	SHUTTER 3 BOARD AND BATTEN, ROUGH SAWN WOODGRAIN
SH3PC18X72RS	70	SHUTTER 3 BOARD AND BATTEN, ROUGH SAWN WOODGRAIN
SH3PC18X84RS	70	SHUTTER 3 BOARD AND BATTEN, ROUGH SAWN WOODGRAIN
SH3PC18X96RS	70	SHUTTER 3 BOARD AND BATTEN, ROUGH SAWN WOODGRAIN
SH3PC18X108RS	70	SHUTTER 3 BOARD AND BATTEN, ROUGH SAWN WOODGRAIN
SH3PC18X120RS	70	SHUTTER 3 BOARD AND BATTEN, ROUGH SAWN WOODGRAIN
PLANK, 3 PLANK DIAMOND 18"		
SH3PD18X24RS	78	SHUTTER 3 PLANK W/DIAMOND, ROUGH SAWN WOODGRAIN
SH3PD18X36RS	78	SHUTTER 3 PLANK W/DIAMOND, ROUGH SAWN WOODGRAIN
SH3PD18X48RS	78	SHUTTER 3 PLANK W/DIAMOND, ROUGH SAWN WOODGRAIN
SH3PD18X60RS	78	SHUTTER 3 PLANK W/DIAMOND, ROUGH SAWN WOODGRAIN
SH3PD18X72RS	78	SHUTTER 3 PLANK W/DIAMOND, ROUGH SAWN WOODGRAIN
SH3PD18X84RS	78	SHUTTER 3 PLANK W/DIAMOND, ROUGH SAWN WOODGRAIN
SH3PD18X96RS	78	SHUTTER 3 PLANK W/DIAMOND, ROUGH SAWN WOODGRAIN
SH3PD18X108RS	78	SHUTTER 3 PLANK W/DIAMOND, ROUGH SAWN WOODGRAIN
SH3PD18X120RS	78	SHUTTER 3 PLANK W/DIAMOND, ROUGH SAWN WOODGRAIN
B&B 3 BOARD, END BATTEN 14"		
SH3PEBC14X24RS	68	SHUTTER 3 BOARD END BATTEN, ROUGH SAWN WOODGRAIN
SH3PEBC14X36RS	68	SHUTTER 3 BOARD END BATTEN, ROUGH SAWN WOODGRAIN
SH3PEBC14X48RS	68	SHUTTER 3 BOARD END BATTEN, ROUGH SAWN WOODGRAIN
SH3PEBC14X60RS	68	SHUTTER 3 BOARD END BATTEN, ROUGH SAWN WOODGRAIN
SH3PEBC14X72RS	68	SHUTTER 3 BOARD END BATTEN, ROUGH SAWN WOODGRAIN
SH3PEBC14X84RS	68	SHUTTER 3 BOARD END BATTEN, ROUGH SAWN WOODGRAIN
SH3PEBC14X96RS	68	SHUTTER 3 BOARD END BATTEN, ROUGH SAWN WOODGRAIN
SH3PEBC14X108RS	68	SHUTTER 3 BOARD END BATTEN, ROUGH SAWN WOODGRAIN
SH3PEBC14X120RS	68	SHUTTER 3 BOARD END BATTEN, ROUGH SAWN WOODGRAIN
B&B 3 BOARD, END BATTEN 18"		
SH3PEBC18X24RS	70	SHUTTER 3 BOARD END BATTEN, ROUGH SAWN WOODGRAIN
SH3PEBC18X36RS	70	SHUTTER 3 BOARD END BATTEN, ROUGH SAWN WOODGRAIN
SH3PEBC18X48RS	70	SHUTTER 3 BOARD END BATTEN, ROUGH SAWN WOODGRAIN
SH3PEBC18X60RS	70	SHUTTER 3 BOARD END BATTEN, ROUGH SAWN WOODGRAIN
SH3PEBC18X72RS	70	SHUTTER 3 BOARD END BATTEN, ROUGH SAWN WOODGRAIN
SH3PEBC18X84RS	70	SHUTTER 3 BOARD END BATTEN, ROUGH SAWN WOODGRAIN
SH3PEBC18X96RS	70	SHUTTER 3 BOARD END BATTEN, ROUGH SAWN WOODGRAIN
SH3PEBC18X108RS	70	SHUTTER 3 BOARD END BATTEN, ROUGH SAWN WOODGRAIN



PART NUMBER	PAGE	DESCRIPTION
SH3PEBC18X120RS	70	SHUTTER 3 BOARD END BATTEN, ROUGH SAWN WOODGRAIN
<b>B&amp;B 3 BOARD, QUARTER ROUND 2 BATTEN 14"</b>		
SH3PHLR14X28RS	69	SHUTTER 3 BOARD ARCH TOP, ROUGH SAWN WOODGRAIN
SH3PHLR14X36RS	69	SHUTTER 3 BOARD ARCH TOP, ROUGH SAWN WOODGRAIN
SH3PHLR14X48RS	69	SHUTTER 3 BOARD ARCH TOP, ROUGH SAWN WOODGRAIN
SH3PHLR14X60RS	69	SHUTTER 3 BOARD ARCH TOP, ROUGH SAWN WOODGRAIN
SH3PHLR14X72RS	69	SHUTTER 3 BOARD ARCH TOP, ROUGH SAWN WOODGRAIN
SH3PHLR14X84RS	69	SHUTTER 3 BOARD ARCH TOP, ROUGH SAWN WOODGRAIN
SH3PHLR14X96RS	69	SHUTTER 3 BOARD ARCH TOP, ROUGH SAWN WOODGRAIN
SH3PHLR14X108RS	69	SHUTTER 3 BOARD ARCH TOP, ROUGH SAWN WOODGRAIN
SH3PHLR14X120RS	69	SHUTTER 3 BOARD ARCH TOP, ROUGH SAWN WOODGRAIN
<b>B&amp;B 3 BOARD, QUARTER ROUND 2 BATTEN 18"</b>		
SH3PHLR18X36RS	71	SHUTTER 3 BOARD ARCH TOP, ROUGH SAWN WOODGRAIN
SH3PHLR18X48RS	71	SHUTTER 3 BOARD ARCH TOP, ROUGH SAWN WOODGRAIN
SH3PHLR18X60RS	71	SHUTTER 3 BOARD ARCH TOP, ROUGH SAWN WOODGRAIN
SH3PHLR18X72RS	71	SHUTTER 3 BOARD ARCH TOP, ROUGH SAWN WOODGRAIN
SH3PHLR18X84RS	71	SHUTTER 3 BOARD ARCH TOP, ROUGH SAWN WOODGRAIN
SH3PHLR18X96RS	71	SHUTTER 3 BOARD ARCH TOP, ROUGH SAWN WOODGRAIN
SH3PHLR18X108RS	71	SHUTTER 3 BOARD ARCH TOP, ROUGH SAWN WOODGRAIN
SH3PHLR18X120RS	71	SHUTTER 3 BOARD ARCH TOP, ROUGH SAWN WOODGRAIN
<b>PLANK, 3 PLANK 2 BATTEN 18"</b>		
SH3P018X24RS	74	SHUTTER 3 PLANK, ROUGH SAWN WOODGRAIN
SH3P018X36RS	74	SHUTTER 3 PLANK, ROUGH SAWN WOODGRAIN
SH3P018X48RS	74	SHUTTER 3 PLANK, ROUGH SAWN WOODGRAIN
SH3P018X60RS	74	SHUTTER 3 PLANK, ROUGH SAWN WOODGRAIN
SH3P018X72RS	74	SHUTTER 3 PLANK, ROUGH SAWN WOODGRAIN
SH3P018X84RS	74	SHUTTER 3 PLANK, ROUGH SAWN WOODGRAIN
SH3P018X96RS	74	SHUTTER 3 PLANK, ROUGH SAWN WOODGRAIN
SH3P018X108RS	74	SHUTTER 3 PLANK, ROUGH SAWN WOODGRAIN
SH3P018X120RS	74	SHUTTER 3 PLANK, ROUGH SAWN WOODGRAIN
<b>PLANK, 3 PLANK Z BATTEN 18"</b>		
SH3PZ18X24RS	74	SHUTTER 3 PLANK Z-BATTEN, ROUGH SAWN WOODGRAIN
SH3PZ18X36RS	74	SHUTTER 3 PLANK Z-BATTEN, ROUGH SAWN WOODGRAIN
SH3PZ18X48RS	74	SHUTTER 3 PLANK Z-BATTEN, ROUGH SAWN WOODGRAIN
SH3PZ18X60RS	74	SHUTTER 3 PLANK Z-BATTEN, ROUGH SAWN WOODGRAIN
SH3PZ18X72RS	74	SHUTTER 3 PLANK Z-BATTEN, ROUGH SAWN WOODGRAIN
SH3PZ18X84RS	74	SHUTTER 3 PLANK Z-BATTEN, ROUGH SAWN WOODGRAIN
SH3PZ18X96RS	74	SHUTTER 3 PLANK Z-BATTEN, ROUGH SAWN WOODGRAIN
SH3PZ18X108RS	74	SHUTTER 3 PLANK Z-BATTEN, ROUGH SAWN WOODGRAIN
SH3PZ18X120RS	74	SHUTTER 3 PLANK Z-BATTEN, ROUGH SAWN WOODGRAIN
<b>B&amp;B 3 BOARD, Z BATTEN 14"</b>		
SH3PZC14X24RS	69	SHUTTER 3 BOARD Z-BATTEN, ROUGH SAWN WOODGRAIN
SH3PZC14X36RS	69	SHUTTER 3 BOARD Z-BATTEN, ROUGH SAWN WOODGRAIN

PART NUMBER	PAGE	DESCRIPTION
SH3PZC14X48RS	69	SHUTTER 3 BOARD Z-BATTEN, ROUGH SAWN WOODGRAIN
SH3PZC14X60RS	69	SHUTTER 3 BOARD Z-BATTEN, ROUGH SAWN WOODGRAIN
SH3PZC14X72RS	69	SHUTTER 3 BOARD Z-BATTEN, ROUGH SAWN WOODGRAIN
SH3PZC14X84RS	69	SHUTTER 3 BOARD Z-BATTEN, ROUGH SAWN WOODGRAIN
SH3PZC14X96RS	69	SHUTTER 3 BOARD Z-BATTEN, ROUGH SAWN WOODGRAIN
SH3PZC14X108RS	69	SHUTTER 3 BOARD Z-BATTEN, ROUGH SAWN WOODGRAIN
SH3PZC14X120RS	69	SHUTTER 3 BOARD Z-BATTEN, ROUGH SAWN WOODGRAIN
<b>B&amp;B 3 BOARD, Z BATTEN 18"</b>		
SH3PZC18X24RS	71	SHUTTER 3 BOARD Z-BATTEN, ROUGH SAWN WOODGRAIN
SH3PZC18X36RS	71	SHUTTER 3 BOARD Z-BATTEN, ROUGH SAWN WOODGRAIN
SH3PZC18X48RS	71	SHUTTER 3 BOARD Z-BATTEN, ROUGH SAWN WOODGRAIN
SH3PZC18X60RS	71	SHUTTER 3 BOARD Z-BATTEN, ROUGH SAWN WOODGRAIN
SH3PZC18X72RS	71	SHUTTER 3 BOARD Z-BATTEN, ROUGH SAWN WOODGRAIN
SH3PZC18X84RS	71	SHUTTER 3 BOARD Z-BATTEN, ROUGH SAWN WOODGRAIN
SH3PZC18X96RS	71	SHUTTER 3 BOARD Z-BATTEN, ROUGH SAWN WOODGRAIN
SH3PZC18X108RS	71	SHUTTER 3 BOARD Z-BATTEN, ROUGH SAWN WOODGRAIN
SH3PZC18X120RS	71	SHUTTER 3 BOARD Z-BATTEN, ROUGH SAWN WOODGRAIN
<b>B&amp;B 4 PLANK, 3 BATTEN 24"</b>		
SH4P3B24X24RS	75	SHUTTER 4 PLANK 3 BATTEN, ROUGH SAWN WOODGRAIN
SH4P3B24X36RS	75	SHUTTER 4 PLANK 3 BATTEN, ROUGH SAWN WOODGRAIN
SH4P3B24X48RS	75	SHUTTER 4 PLANK 3 BATTEN, ROUGH SAWN WOODGRAIN
SH4P3B24X60RS	75	SHUTTER 4 PLANK 3 BATTEN, ROUGH SAWN WOODGRAIN
SH4P3B24X72RS	75	SHUTTER 4 PLANK 3 BATTEN, ROUGH SAWN WOODGRAIN
SH4P3B24X84RS	75	SHUTTER 4 PLANK 3 BATTEN, ROUGH SAWN WOODGRAIN
SH4P3B24X96RS	75	SHUTTER 4 PLANK 3 BATTEN, ROUGH SAWN WOODGRAIN
SH4P3B24X108RS	75	SHUTTER 4 PLANK 3 BATTEN, ROUGH SAWN WOODGRAIN
SH4P3B24X120RS	75	SHUTTER 4 PLANK 3 BATTEN, ROUGH SAWN WOODGRAIN
<b>B&amp;B 4 BOARD, 3 BATTEN 24"</b>		
SH4P3BC24X24RS	72	SHUTTER 4 BOARD 3 BATTEN, ROUGH SAWN WOODGRAIN
SH4P3BC24X36RS	72	SHUTTER 4 BOARD 3 BATTEN, ROUGH SAWN WOODGRAIN
SH4P3BC24X48RS	72	SHUTTER 4 BOARD 3 BATTEN, ROUGH SAWN WOODGRAIN
SH4P3BC24X60RS	72	SHUTTER 4 BOARD 3 BATTEN, ROUGH SAWN WOODGRAIN
SH4P3BC24X72RS	72	SHUTTER 4 BOARD 3 BATTEN, ROUGH SAWN WOODGRAIN
SH4P3BC24X84RS	72	SHUTTER 4 BOARD 3 BATTEN, ROUGH SAWN WOODGRAIN
SH4P3BC24X96RS	72	SHUTTER 4 BOARD 3 BATTEN, ROUGH SAWN WOODGRAIN
SH4P3BC24X108RS	72	SHUTTER 4 BOARD 3 BATTEN, ROUGH SAWN WOODGRAIN
SH4P3BC24X120RS	72	SHUTTER 4 BOARD 3 BATTEN, ROUGH SAWN WOODGRAIN
<b>B&amp;B 4 BOARD, 2 BATTEN 24"</b>		
SH4PC24X24RS	72	SHUTTER 4 BOARD AND BATTEN, ROUGH SAWN WOODGRAIN
SH4PC24X36RS	72	SHUTTER 4 BOARD AND BATTEN, ROUGH SAWN WOODGRAIN
SH4PC24X48RS	72	SHUTTER 4 BOARD AND BATTEN, ROUGH SAWN WOODGRAIN
SH4PC24X60RS	72	SHUTTER 4 BOARD AND BATTEN, ROUGH SAWN WOODGRAIN
SH4PC24X72RS	72	SHUTTER 4 BOARD AND BATTEN, ROUGH SAWN WOODGRAIN

PART NUMBER	PAGE	DESCRIPTION
SH4PC24X84RS	72	SHUTTER 4 BOARD AND BATTEN, ROUGH SAWN WOODGRAIN
SH4PC24X96RS	72	SHUTTER 4 BOARD AND BATTEN, ROUGH SAWN WOODGRAIN
SH4PC24X108RS	72	SHUTTER 4 BOARD AND BATTEN, ROUGH SAWN WOODGRAIN
SH4PC24X120RS	72	SHUTTER 4 BOARD AND BATTEN, ROUGH SAWN WOODGRAIN
PLANK, 4 PLANK 3 BATTEN 24"		
SH4PD24X24RS	78	SHUTTER 4 PLANK W/DIAMOND, ROUGH SAWN WOODGRAIN
SH4PD24X36RS	78	SHUTTER 4 PLANK W/DIAMOND, ROUGH SAWN WOODGRAIN
SH4PD24X48RS	78	SHUTTER 4 PLANK W/DIAMOND, ROUGH SAWN WOODGRAIN
SH4PD24X60RS	78	SHUTTER 4 PLANK W/DIAMOND, ROUGH SAWN WOODGRAIN
SH4PD24X72RS	78	SHUTTER 4 PLANK W/DIAMOND, ROUGH SAWN WOODGRAIN
SH4PD24X84RS	78	SHUTTER 4 PLANK W/DIAMOND, ROUGH SAWN WOODGRAIN
SH4PD24X96RS	78	SHUTTER 4 PLANK W/DIAMOND, ROUGH SAWN WOODGRAIN
SH4PD24X108RS	78	SHUTTER 4 PLANK W/DIAMOND, ROUGH SAWN WOODGRAIN
SH4PD24X120RS	78	SHUTTER 4 PLANK W/DIAMOND, ROUGH SAWN WOODGRAIN
B&B 4 BOARD, END BATTEN 24"		
SH4PEBC24X24RS	72	SHUTTER 4 BOARD AND END BATTEN, ROUGH SAWN WOODGRAIN
SH4PEBC24X36RS	72	SHUTTER 4 BOARD AND END BATTEN, ROUGH SAWN WOODGRAIN
SH4PEBC24X48RS	72	SHUTTER 4 BOARD AND END BATTEN, ROUGH SAWN WOODGRAIN
SH4PEBC24X60RS	72	SHUTTER 4 BOARD AND END BATTEN, ROUGH SAWN WOODGRAIN
SH4PEBC24X72RS	72	SHUTTER 4 BOARD AND END BATTEN, ROUGH SAWN WOODGRAIN
SH4PEBC24X84RS	72	SHUTTER 4 BOARD AND END BATTEN, ROUGH SAWN WOODGRAIN
SH4PEBC24X96RS	72	SHUTTER 4 BOARD AND END BATTEN, ROUGH SAWN WOODGRAIN
SH4PEBC24X108RS	72	SHUTTER 4 BOARD AND END BATTEN, ROUGH SAWN
SH4PEBC24X120RS	72	SHUTTER 4 BOARD AND END BATTEN, ROUGH SAWN
B&B 4 BOARD, QUARTER ROUND 2 BATTEN 24"		
SH4PHLR24X48RS	73	SHUTTER 4 ARCH TOP BOARD AND BATTEN, ROUGH SAWN
SH4PHLR24X60RS	73	SHUTTER 4 ARCH TOP BOARD AND BATTEN, ROUGH SAWN
SH4PHLR24X72RS	73	SHUTTER 4 ARCH TOP BOARD AND BATTEN, ROUGH SAWN
SH4PHLR24X84RS	73	SHUTTER 4 ARCH TOP BOARD AND BATTEN, ROUGH SAWN
SH4PHLR24X96RS	73	SHUTTER 4 ARCH TOP BOARD AND BATTEN, ROUGH SAWN
SH4PHLR24X108RS	73	SHUTTER 4 ARCH TOP BOARD AND BATTEN, ROUGH SAWN
SH4PHLR24X120RS	73	SHUTTER 4 ARCH TOP BOARD AND BATTEN, ROUGH SAWN
PLANK, 4 PLANK 2 BATTEN 24"		
SH4P024X24RS	75	SHUTTER 4 PLANK, ROUGH SAWN WOODGRAIN
SH4P024X36RS	75	SHUTTER 4 PLANK, ROUGH SAWN WOODGRAIN
SH4P024X48RS	75	SHUTTER 4 PLANK, ROUGH SAWN WOODGRAIN
SH4P024X60RS	75	SHUTTER 4 PLANK, ROUGH SAWN WOODGRAIN
SH4P024X72RS	75	SHUTTER 4 PLANK, ROUGH SAWN WOODGRAIN
SH4P024X84RS	75	SHUTTER 4 PLANK, ROUGH SAWN WOODGRAIN
SH4P024X96RS	75	SHUTTER 4 PLANK, ROUGH SAWN WOODGRAIN
SH4P024X108RS	75	SHUTTER 4 PLANK, ROUGH SAWN WOODGRAIN
SH4P024X120RS	75	SHUTTER 4 PLANK, ROUGH SAWN WOODGRAIN
PLANK, 4 PLANK Z BATTEN 24"		
SH4PZ24X24RS	75	SHUTTER 4 PLANK, ROUGH SAWN WOODGRAIN
SH4PZ24X36RS	75	SHUTTER 4 PLANK, ROUGH SAWN WOODGRAIN
SH4PZ24X48RS	75	SHUTTER 4 PLANK, ROUGH SAWN WOODGRAIN

PART NUMBER	PAGE	DESCRIPTION
SH4PZ24X60RS	75	SHUTTER 4 PLANK, ROUGH SAWN WOODGRAIN
SH4PZ24X72RS	75	SHUTTER 4 PLANK, ROUGH SAWN WOODGRAIN
SH4PZ24X84RS	75	SHUTTER 4 PLANK, ROUGH SAWN WOODGRAIN
SH4PZ24X96RS	75	SHUTTER 4 PLANK, ROUGH SAWN WOODGRAIN
SH4PZ24X108RS	75	SHUTTER 4 PLANK, ROUGH SAWN WOODGRAIN
SH4PZ24X120RS	75	SHUTTER 4 PLANK, ROUGH SAWN WOODGRAIN
B&B 4 BOARD, Z BATTEN 24"		
SH4PZC24X24RS	73	SHUTTER 4 BOARD AND Z-BATTEN, ROUGH SAWN WOODGRAIN
SH4PZC24X36RS	73	SHUTTER 4 BOARD AND Z-BATTEN, ROUGH SAWN WOODGRAIN
SH4PZC24X48RS	73	SHUTTER 4 BOARD AND Z-BATTEN, ROUGH SAWN WOODGRAIN
SH4PZC24X60RS	73	SHUTTER 4 BOARD AND Z-BATTEN, ROUGH SAWN WOODGRAIN
SH4PZC24X72RS	73	SHUTTER 4 BOARD AND Z-BATTEN, ROUGH SAWN WOODGRAIN
SH4PZC24X84RS	73	SHUTTER 4 BOARD AND Z-BATTEN, ROUGH SAWN WOODGRAIN
SH4PZC24X96RS	73	SHUTTER 4 BOARD AND Z-BATTEN, ROUGH SAWN WOODGRAIN
SH4PZC24X108RS	73	SHUTTER 4 BOARD AND Z-BATTEN, ROUGH SAWN WOODGRAIN
SH4PZC24X120RS	73	SHUTTER 4 BOARD AND Z-BATTEN, ROUGH SAWN WOODGRAIN
SHUTTER BOARDS		
SHBB12X144RS	80	SHUTTER BOARD 2 BOARD, WOODGRAIN
SHBB12X144RS-CP	80	SHUTTER BOARD 2 BOARD, WOODGRAIN CONTRACTOR
SHBB14X144RS	80	SHUTTER BOARD 3 BOARD, WOODGRAIN
SHBB14X144RS-CP	80	SHUTTER BOARD 3 BOARD, WOODGRAIN CONTRACTOR
SHBB18X144RS	80	SHUTTER BOARD 3 BOARD, WOODGRAIN
SHBB18X144RS-CP	80	SHUTTER BOARD 3 BOARD, WOODGRAIN CONTRACTOR
SHBB24X144RS	80	SHUTTER BOARD 4 BOARD, WOODGRAIN
SHBB24X144RS-CP	80	SHUTTER BOARD 4 BOARD, WOODGRAIN CONTRACTOR
SHSFP12X144	62	SHAKER SHUTTER BOARDS 12X144 SMOOTH
SHSFP16X144	62	SHAKER SHUTTER BOARDS 16X144 SMOOTH
SHSFP18X144	62	SHAKER SHUTTER BOARDS 18X144 SMOOTH
SHSFP24X144	62	SHAKER SHUTTER BOARDS 24X144 SMOOTH
B&B & PLANK SHUTTER ACCESSORIES		
SHCLAPYR1.25	81	SHUTTER CLAVOS PYRAMID STYLE
SHCLAPYR1.25-100PACK	81	SHUTTER CLAVOS PYRAMID STYLE 1.25IN. (QTY 100)
SHCLAPYR1.25-12PACK	81	SHUTTER CLAVOS PYRAMID STYLE 1.25IN. (QTY 12)
SHCLAPYR1.25-18PACK	81	SHUTTER CLAVOS PYRAMID STYLE 1.25IN. (QTY 18)
SHCLAPYR1.25-24PACK	81	SHUTTER CLAVOS PYRAMID STYLE 1.25IN. (QTY 24)
SHCLAPYR1.25-8PACK	81	SHUTTER CLAVOS PYRAMID STYLE 1.25IN. (QTY 8)
SHCLARND1.25	81	SHUTTER CLAVOS ROUND STYLE
SHCLARND1.25-100PACK	81	SHUTTER CLAVOS ROUND STYLE 1.25IN. (QTY 100)
SHCLARND1.25-12PACK	81	SHUTTER CLAVOS ROUND STYLE 1.25IN (QTY 12)
SHCLARND1.25-18PACK	81	SHUTTER CLAVOS ROUND STYLE 1.25IN (QTY 18)
SHCLARND1.25-24PACK	81	SHUTTER CLAVOS PYRAMID STYLE 1.25IN. (QTY 24)
SHCLARND1.25-8PACK	81	SHUTTER CLAVOS ROUND STYLE 1.25IN (QTY 8)
SHHNGCOL10	81	SHUTTER HINGE COLONIAL STYLE
SHHNGCOL16	81	SHUTTER HINGE COLONIAL STYLE
SHHNGSPR10	81	SHUTTER HINGE SPEAR STYLE
SHHNGSPR16	81	SHUTTER HINGE SPEAR STYLE

PART NUMBER	PAGE	DESCRIPTION
<b>SHAKER MODERN FARMHOUSE 12"</b>		
<b>SHMHF12X__</b>	58	SHAKER MODERN FARMHOUSE SHUTTER
<b>SHAKER MODERN FARMHOUSE 16"</b>		
<b>SHMHF16X__</b>	58	SHAKER MODERN FARMHOUSE SHUTTER
<b>SHAKER MODERN FARMHOUSE 18"</b>		
<b>SHMHF18X__</b>	58	SHAKER MODERN FARMHOUSE SHUTTER
<b>SHAKER MODERN FARMHOUSE 24"</b>		
<b>SHMHF24X__</b>	58	SHAKER MODERN FARMHOUSE SHUTTER
<b>SP56</b>	38	PEDIMENT SUNBURST SMOOTH
<b>SP86</b>	38	PEDIMENT SUNBURST SMOOTH
<b>SP91</b>	38	PEDIMENT SUNBURST SMOOTH
<b>SP667</b>	38	PEDIMENT SUNBURST SMOOTH
<b>STRPOSTKIT96</b>	205	STRUCTURAL POST, 96"
<b>STRPOSTKIT108</b>	205	STRUCTURAL POST, 108"
<b>STRPOSTKIT120</b>	205	STRUCTURAL POST, 120"
<b>SWDH24X12</b>	37	PEDIMENT HALF ROUND SUNBURST SMOOTH
<b>SWDH28X14</b>	37	PEDIMENT HALF ROUND SUNBURST SMOOTH
<b>SWDH30X15</b>	37	PEDIMENT HALF ROUND SUNBURST SMOOTH
<b>SWDH32X16</b>	37	PEDIMENT HALF ROUND SUNBURST SMOOTH
<b>SWDH33X17</b>	37	PEDIMENT HALF ROUND SUNBURST SMOOTH
<b>SWDH36X18</b>	37	PEDIMENT HALF ROUND SUNBURST SMOOTH
<b>SWDH36X18-4FK</b>	38	PEDIMENT HALF RND SUNBURST W/FLT TRIM & KEY SMOOTH
<b>SWDH36X9</b>	36	PEDIMENT SEGMENT SUNBURST SMOOTH
<b>SWDH37X19</b>	37	PEDIMENT HALF ROUND SUNBURST SMOOTH
<b>SWDH40X10</b>	36	PEDIMENT SEGMENT SUNBURST SMOOTH
<b>SWDH40X20</b>	37	PEDIMENT HALF ROUND SUNBURST SMOOTH
<b>SWDH42X21</b>	37	PEDIMENT HALF ROUND SUNBURST SMOOTH
<b>SWDH44X22</b>	37	PEDIMENT HALF ROUND SUNBURST SMOOTH
<b>SWDH48X13</b>	36	PEDIMENT SEGMENT SUNBURST SMOOTH
<b>SWDH48X24</b>	37	PEDIMENT HALF ROUND SUNBURST SMOOTH
<b>SWDH56X28</b>	37	PEDIMENT HALF ROUND SUNBURST SMOOTH
<b>SWDH60X30</b>	37	PEDIMENT HALF ROUND SUNBURST SMOOTH
<b>SWDH64X32</b>	36	PEDIMENT HALF ROUND SUNBURST SMOOTH
<b>SWDH68X14</b>	36	PEDIMENT SEGMENT SUNBURST SMOOTH
<b>SWDH68X34</b>	37	PEDIMENT HALF ROUND SUNBURST SMOOTH
<b>SWDH72X14</b>	36	PEDIMENT SEGMENT SUNBURST SMOOTH
<b>SWDH72X36</b>	37	PEDIMENT HALF ROUND SUNBURST SMOOTH
<b>SWDH76X15</b>	36	PEDIMENT SEGMENT SUNBURST SMOOTH
<b>SWDH76X38</b>	37	PEDIMENT HALF ROUND SUNBURST SMOOTH
<b>SWDH80X15</b>	36	PEDIMENT SEGMENT SUNBURST SMOOTH
<b>SWDH100X50</b>	37	PEDIMENT HALF ROUND SUNBURST SMOOTH
<b>T</b>		
<b>TC6</b>	251	NEWEL POST TRIM COLLAR SMOOTH
<b>TC8</b>	251	NEWEL POST TRIM COLLAR SMOOTH
<b>TC8-8</b>	251	NEWEL POST TRIM COLLAR SMOOTH
<b>TRLS18987</b>	159	TRELLIS KIT, TIMBER TEXTURE, INSTALLED

PART NUMBER	PAGE	DESCRIPTION
<b>TRLS18988</b>	159	TRELLIS KIT, TIMBER TEXTURE, INSTALLED
<b>TRLS18989</b>	158,159	TRELLIS HARDWARE KIT
<b>TRLS18994</b>	158,159	TRELLIS HARDWARE KIT
<b>TRLS19003</b>	158	TRELLIS KIT SMOOTH
<b>TRLS19004</b>	158	TRELLIS KIT SMOOTH
<b>TRLV36X18</b>	200	TRIANGLE LOUVER DECO SMOOTH
<b>TRLV42X21</b>	200	TRIANGLE LOUVER DECO SMOOTH
<b>TRLV48X12</b>	200	TRIANGLE LOUVER DECO SMOOTH
<b>TRLV48X18</b>	200	TRIANGLE LOUVER DECO SMOOTH
<b>TRLV48X22</b>	200	TRIANGLE LOUVER DECO SMOOTH
<b>TRLV48X24</b>	200	TRIANGLE LOUVER DECO SMOOTH
<b>TRLV60X18</b>	200	TRIANGLE LOUVER DECO SMOOTH
<b>TRLV60X23</b>	200	TRIANGLE LOUVER DECO SMOOTH
<b>TRLV60X25</b>	200	TRIANGLE LOUVER DECO SMOOTH
<b>TRLV60X30</b>	200	TRIANGLE LOUVER DECO SMOOTH
<b>TRLV64X27</b>	200	TRIANGLE LOUVER DECO SMOOTH
<b>TRLV64X32</b>	200	TRIANGLE LOUVER DECO SMOOTH
<b>TRLV66X22</b>	200	TRIANGLE LOUVER DECO SMOOTH
<b>TRLV72X36</b>	200	TRIANGLE LOUVER DECO SMOOTH
<b>TRLV76X19</b>	200	TRIANGLE LOUVER DECO SMOOTH
<b>TRLV84X18</b>	200	TRIANGLE LOUVER DECO SMOOTH
<b>TRLV84X21</b>	200	TRIANGLE LOUVER DECO SMOOTH
<b>TRLV88X22</b>	200	TRIANGLE LOUVER DECO SMOOTH
<b>TRLVLR60X25</b>	201	2PC TRIANGLE LOUVER DECO SMOOTH
<b>TRLVLR60X30</b>	201	2PC TRIANGLE LOUVER DECO SMOOTH
<b>TRLVLR108X27</b>	201	2PC TRIANGLE LOUVER DECO SMOOTH
<b>TRLVLR115X35</b>	201	2PC TRIANGLE LOUVER DECO SMOOTH
<b>TRLVLR120X30</b>	201	2PC TRIANGLE LOUVER DECO SMOOTH
<b>TV20X20-3FR</b>	180	TILE VENT, SMOOTH, 3 HOLE FULL ROUND
<b>W</b>		
<b>6" Crosshead</b>		
<b>WCH24X6</b>	29	CROSSHEAD SMOOTH
<b>WCH24X6D</b>	29	CROSSHEAD W/DT SMOOTH
<b>WCH24X6K</b>	29	CROSSHEAD W/KEY SMOOTH
<b>WCH24X6T</b>	29	CROSSHEAD W/TS SMOOTH
<b>WCH24X7BT</b>	29	CROSSHEAD W/BT SMOOTH
<b>WCH28X6</b>	29	CROSSHEAD SMOOTH
<b>WCH28X6D</b>	29	CROSSHEAD W/DT SMOOTH
<b>WCH28X6K</b>	29	CROSSHEAD W/KEY SMOOTH
<b>WCH28X6T</b>	29	CROSSHEAD W/TS SMOOTH
<b>WCH28X7BT</b>	29	CROSSHEAD W/BT SMOOTH
<b>WCH30X6</b>	29	CROSSHEAD SMOOTH
<b>WCH30X6D</b>	29	CROSSHEAD W/DT SMOOTH
<b>WCH30X6K</b>	29	CROSSHEAD W/KEY SMOOTH
<b>WCH30X6T</b>	29	CROSSHEAD W/TS SMOOTH
<b>WCH30X7BT</b>	29	CROSSHEAD W/BT SMOOTH

PART NUMBER	PAGE	DESCRIPTION
WCH31X6	29	CROSSHEAD SMOOTH
WCH31X6D	29	CROSSHEAD W/DT SMOOTH
WCH31X6K	29	CROSSHEAD W/KEY SMOOTH
WCH31X6T	29	CROSSHEAD W/TS SMOOTH
WCH31X7BT	29	CROSSHEAD W/BT SMOOTH
WCH32X6	29	CROSSHEAD SMOOTH
WCH32X6D	29	CROSSHEAD W/DT SMOOTH
WCH32X6K	29	CROSSHEAD W/KEY SMOOTH
WCH32X6T	29	CROSSHEAD W/TS SMOOTH
WCH32X7BT	29	CROSSHEAD W/BT SMOOTH
WCH33X6	29	CROSSHEAD SMOOTH
WCH33X6D	29	CROSSHEAD W/DT SMOOTH
WCH33X6K	29	CROSSHEAD W/KEY SMOOTH
WCH33X6T	29	CROSSHEAD W/TS SMOOTH
WCH33X7BT	29	CROSSHEAD W/BT SMOOTH
WCH34X6	29	CROSSHEAD SMOOTH
WCH34X6D	29	CROSSHEAD W/DT SMOOTH
WCH34X6K	29	CROSSHEAD W/KEY SMOOTH
WCH34X6T	29	CROSSHEAD W/TS SMOOTH
WCH34X7BT	29	CROSSHEAD W/BT SMOOTH
WCH35X6	29	CROSSHEAD SMOOTH
WCH35X6D	29	CROSSHEAD W/DT SMOOTH
WCH35X6K	29	CROSSHEAD W/KEY SMOOTH
WCH35X6T	29	CROSSHEAD W/TS SMOOTH
WCH35X7BT	29	CROSSHEAD W/BT SMOOTH
WCH36X6	29	CROSSHEAD SMOOTH
WCH36X6D	29	CROSSHEAD W/DT SMOOTH
WCH36X6K	29	CROSSHEAD W/KEY SMOOTH
WCH36X6T	29	CROSSHEAD W/TS SMOOTH
WCH36X7BT	29	CROSSHEAD W/BT SMOOTH
WCH37X6	29	CROSSHEAD SMOOTH
WCH37X6D	29	CROSSHEAD W/DT SMOOTH
WCH37X6K	29	CROSSHEAD W/KEY SMOOTH
WCH37X6T	29	CROSSHEAD W/TS SMOOTH
WCH37X7BT	29	CROSSHEAD W/BT SMOOTH
WCH38X6	29	CROSSHEAD SMOOTH
WCH38X6D	29	CROSSHEAD W/DT SMOOTH
WCH38X6K	29	CROSSHEAD W/KEY SMOOTH
WCH38X6T	29	CROSSHEAD W/TS SMOOTH
WCH38X7BT	29	CROSSHEAD W/BT SMOOTH
WCH40X6	29	CROSSHEAD SMOOTH
WCH40X6D	29	CROSSHEAD W/DT SMOOTH
WCH40X6K	29	CROSSHEAD W/KEY SMOOTH
WCH40X6T	29	CROSSHEAD W/TS SMOOTH
WCH40X7BT	29	CROSSHEAD W/BT SMOOTH
WCH41X6	29	CROSSHEAD SMOOTH

PART NUMBER	PAGE	DESCRIPTION
WCH41X6D	29	CROSSHEAD W/DT SMOOTH
WCH41X6K	29	CROSSHEAD W/KEY SMOOTH
WCH41X6T	29	CROSSHEAD W/TS SMOOTH
WCH41X7BT	29	CROSSHEAD W/BT SMOOTH
WCH43X6	29	CROSSHEAD SMOOTH
WCH43X6D	29	CROSSHEAD W/DT SMOOTH
WCH43X6K	29	CROSSHEAD W/KEY SMOOTH
WCH43X6T	29	CROSSHEAD W/TS SMOOTH
WCH43X7BT	29	CROSSHEAD W/BT SMOOTH
WCH44X6	29	CROSSHEAD SMOOTH
WCH44X6D	29	CROSSHEAD W/DT SMOOTH
WCH44X6K	29	CROSSHEAD W/KEY SMOOTH
WCH44X6T	29	CROSSHEAD W/TS SMOOTH
WCH44X7BT	29	CROSSHEAD W/BT SMOOTH
WCH46X6	29	CROSSHEAD SMOOTH
WCH46X6D	29	CROSSHEAD W/DT SMOOTH
WCH46X6K	29	CROSSHEAD W/KEY SMOOTH
WCH46X6T	29	CROSSHEAD W/TS SMOOTH
WCH46X7BT	29	CROSSHEAD W/BT SMOOTH
WCH47X6	29	CROSSHEAD SMOOTH
WCH47X6D	29	CROSSHEAD W/DT SMOOTH
WCH47X6K	29	CROSSHEAD W/KEY SMOOTH
WCH47X6T	29	CROSSHEAD W/TS SMOOTH
WCH47X7BT	29	CROSSHEAD W/BT SMOOTH
WCH48X6	29	CROSSHEAD SMOOTH
WCH48X6D	29	CROSSHEAD W/DT SMOOTH
WCH48X6K	29	CROSSHEAD W/KEY SMOOTH
WCH48X6T	29	CROSSHEAD W/TS SMOOTH
WCH48X7BT	29	CROSSHEAD W/BT SMOOTH
WCH50X6	29	CROSSHEAD SMOOTH
WCH50X6D	29	CROSSHEAD W/DT SMOOTH
WCH50X6K	29	CROSSHEAD W/KEY SMOOTH
WCH50X6T	29	CROSSHEAD W/TS SMOOTH
WCH50X7BT	29	CROSSHEAD W/BT SMOOTH
WCH51X6	29	CROSSHEAD SMOOTH
WCH51X6D	29	CROSSHEAD W/DT SMOOTH
WCH51X6K	29	CROSSHEAD W/KEY SMOOTH
WCH51X6T	29	CROSSHEAD W/TS SMOOTH
WCH51X7BT	29	CROSSHEAD W/BT SMOOTH
WCH52X6	29	CROSSHEAD SMOOTH
WCH52X6D	29	CROSSHEAD W/DT SMOOTH
WCH52X6K	29	CROSSHEAD W/KEY SMOOTH
WCH52X6T	29	CROSSHEAD W/TS SMOOTH
WCH52X7BT	29	CROSSHEAD W/BT SMOOTH
WCH54X6	29	CROSSHEAD SMOOTH
WCH54X6D	29	CROSSHEAD W/DT SMOOTH

PART NUMBER	PAGE	DESCRIPTION
WCH54X6K	29	CROSSHEAD W/KEY SMOOTH
WCH54X6T	29	CROSSHEAD W/TS SMOOTH
WCH54X7BT	29	CROSSHEAD W/BT SMOOTH
WCH56X6	29	CROSSHEAD SMOOTH
WCH56X6D	29	CROSSHEAD W/DT SMOOTH
WCH56X6K	29	CROSSHEAD W/KEY SMOOTH
WCH56X6T	29	CROSSHEAD W/TS SMOOTH
WCH56X7BT	29	CROSSHEAD W/BT SMOOTH
WCH60X6	29	CROSSHEAD SMOOTH
WCH60X6D	29	CROSSHEAD W/DT SMOOTH
WCH60X6K	29	CROSSHEAD W/KEY SMOOTH
WCH60X6T	29	CROSSHEAD W/TS SMOOTH
WCH60X7BT	29	CROSSHEAD W/BT SMOOTH
WCH64X6	29	CROSSHEAD SMOOTH
WCH64X6D	29	CROSSHEAD W/DT SMOOTH
WCH64X6K	29	CROSSHEAD W/KEY SMOOTH
WCH64X6T	29	CROSSHEAD W/TS SMOOTH
WCH64X7BT	29	CROSSHEAD W/BT SMOOTH
WCH66X6	29	CROSSHEAD SMOOTH
WCH66X6D	29	CROSSHEAD W/DT SMOOTH
WCH66X6K	29	CROSSHEAD W/KEY SMOOTH
WCH66X6T	29	CROSSHEAD W/TS SMOOTH
WCH66X7BT	29	CROSSHEAD W/BT SMOOTH
WCH67X6	29	CROSSHEAD SMOOTH
WCH67X6D	29	CROSSHEAD W/DT SMOOTH
WCH67X6K	29	CROSSHEAD W/KEY SMOOTH
WCH67X6T	29	CROSSHEAD W/TS SMOOTH
WCH67X7BT	29	CROSSHEAD W/BT SMOOTH
WCH68X6	29	CROSSHEAD SMOOTH
WCH68X6D	29	CROSSHEAD W/DT SMOOTH
WCH68X6K	29	CROSSHEAD W/KEY SMOOTH
WCH68X6T	29	CROSSHEAD W/TS SMOOTH
WCH68X7BT	29	CROSSHEAD W/BT SMOOTH
WCH72X6	29	CROSSHEAD SMOOTH
WCH72X6D	29	CROSSHEAD W/DT SMOOTH
WCH72X6K	29	CROSSHEAD W/KEY SMOOTH
WCH72X6T	29	CROSSHEAD W/TS SMOOTH
WCH72X7BT	29	CROSSHEAD W/BT SMOOTH
WCH73X6	29	CROSSHEAD SMOOTH
WCH73X6D	29	CROSSHEAD W/DT SMOOTH
WCH73X6K	29	CROSSHEAD W/KEY SMOOTH
WCH73X6T	29	CROSSHEAD W/TS SMOOTH
WCH73X7BT	29	CROSSHEAD W/BT SMOOTH
WCH74X6	29	CROSSHEAD SMOOTH
WCH74X6D	29	CROSSHEAD W/DT SMOOTH
WCH74X6K	29	CROSSHEAD W/KEY SMOOTH

PART NUMBER	PAGE	DESCRIPTION
WCH74X6T	29	CROSSHEAD W/TS SMOOTH
WCH74X7BT	29	CROSSHEAD W/BT SMOOTH
WCH76X6	29	CROSSHEAD SMOOTH
WCH76X6D	29	CROSSHEAD W/DT SMOOTH
WCH76X6K	29	CROSSHEAD W/KEY SMOOTH
WCH76X6T	29	CROSSHEAD W/TS SMOOTH
WCH76X7BT	29	CROSSHEAD W/BT SMOOTH
WCH78X6	29	CROSSHEAD SMOOTH
WCH78X6D	29	CROSSHEAD W/DT SMOOTH
WCH78X6K	29	CROSSHEAD W/KEY SMOOTH
WCH78X6T	29	CROSSHEAD W/TS SMOOTH
WCH78X7BT	29	CROSSHEAD W/BT SMOOTH
WCH79X6	29	CROSSHEAD SMOOTH
WCH79X6D	29	CROSSHEAD W/DT SMOOTH
WCH79X6K	29	CROSSHEAD W/KEY SMOOTH
WCH79X6T	29	CROSSHEAD W/TS SMOOTH
WCH79X7BT	29	CROSSHEAD W/BT SMOOTH
WCH80X6	29	CROSSHEAD SMOOTH
WCH80X6D	29	CROSSHEAD W/DT SMOOTH
WCH80X6K	29	CROSSHEAD W/KEY SMOOTH
WCH80X6T	29	CROSSHEAD W/TS SMOOTH
WCH80X7BT	29	CROSSHEAD W/BT SMOOTH
WCH80.5X6	29	CROSSHEAD SMOOTH
WCH80.5X6D	29	CROSSHEAD W/DT SMOOTH
WCH80.5X6K	29	CROSSHEAD W/KEY SMOOTH
WCH80.5X6T	29	CROSSHEAD W/TS SMOOTH
WCH80.5X7BT	29	CROSSHEAD W/BT SMOOTH
WCH84X6	29	CROSSHEAD SMOOTH
WCH84X6D	29	CROSSHEAD W/DT SMOOTH
WCH84X6K	29	CROSSHEAD W/KEY SMOOTH
WCH84X6T	29	CROSSHEAD W/TS SMOOTH
WCH84X7BT	29	CROSSHEAD W/BT SMOOTH
WCH86X6	29	CROSSHEAD SMOOTH
WCH86X6D	29	CROSSHEAD W/DT SMOOTH
WCH86X6K	29	CROSSHEAD W/KEY SMOOTH
WCH86X6T	29	CROSSHEAD W/TS SMOOTH
WCH86X7BT	29	CROSSHEAD W/BT SMOOTH
WCH87X6	29	CROSSHEAD SMOOTH
WCH87X6D	29	CROSSHEAD W/DT SMOOTH
WCH87X6K	29	CROSSHEAD W/KEY SMOOTH
WCH87X6T	29	CROSSHEAD W/TS SMOOTH
WCH87X7BT	29	CROSSHEAD W/BT SMOOTH
WCH96X6	29	CROSSHEAD SMOOTH
WCH96X6D	29	CROSSHEAD W/DT SMOOTH
WCH96X6K	29	CROSSHEAD W/KEY SMOOTH
WCH96X6T	29	CROSSHEAD W/TS SMOOTH

PART NUMBER	PAGE	DESCRIPTION
WCH96X7BT	29	CROSSHEAD W/BT SMOOTH
WCH100X6	29	CROSSHEAD SMOOTH
WCH100X6D	29	CROSSHEAD W/DT SMOOTH
WCH100X6K	29	CROSSHEAD W/KEY SMOOTH
WCH100X6T	29	CROSSHEAD W/TS SMOOTH
WCH100X7BT	29	CROSSHEAD W/BT SMOOTH
WCH103X6	29	CROSSHEAD SMOOTH
WCH103X6D	29	CROSSHEAD W/DT SMOOTH
WCH103X6K	29	CROSSHEAD W/KEY SMOOTH
WCH103X6T	29	CROSSHEAD W/TS SMOOTH
WCH103X7BT	29	CROSSHEAD W/BT SMOOTH
WCH104X6	29	CROSSHEAD SMOOTH
WCH104X6D	29	CROSSHEAD W/DT SMOOTH
WCH104X6K	29	CROSSHEAD W/KEY SMOOTH
WCH104X6T	29	CROSSHEAD W/TS SMOOTH
WCH104X7BT	29	CROSSHEAD W/BT SMOOTH
WCH108X6	29	CROSSHEAD SMOOTH
WCH108X6D	29	CROSSHEAD W/DT SMOOTH
WCH108X6K	29	CROSSHEAD W/KEY SMOOTH
WCH108X6T	29	CROSSHEAD W/TS SMOOTH
WCH108X7BT	29	CROSSHEAD W/BT SMOOTH
WCH110X6	29	CROSSHEAD SMOOTH
WCH110X6D	29	CROSSHEAD W/DT SMOOTH
WCH110X6K	29	CROSSHEAD W/KEY SMOOTH
WCH110X6T	29	CROSSHEAD W/TS SMOOTH
WCH110X7BT	29	CROSSHEAD W/BT SMOOTH
WCH144X6	29	CROSSHEAD SMOOTH
WCH144X6D	29	CROSSHEAD W/DT SMOOTH
WCH144X6K	29	CROSSHEAD W/KEY SMOOTH
WCH144X6T	29	CROSSHEAD W/TS SMOOTH
WCH144X7BT	29	CROSSHEAD W/BT SMOOTH
<b>9" CROSSHEAD</b>		
WCH20X9	30	CROSSHEAD SMOOTH
WCH20X9D	30	CROSSHEAD W/DT SMOOTH
WCH20X9K	30	CROSSHEAD W/KEY SMOOTH
WCH20X9T	30	CROSSHEAD W/TS SMOOTH
WCH20X10BT	30	CROSSHEAD W/BT SMOOTH
WCH24X9	30	CROSSHEAD SMOOTH
WCH24X9D	30	CROSSHEAD W/DT SMOOTH
WCH24X9K	30	CROSSHEAD W/KEY SMOOTH
WCH24X9T	30	CROSSHEAD W/TS SMOOTH
WCH24X10BT	30	CROSSHEAD W/BT SMOOTH
WCH25X9	30	CROSSHEAD SMOOTH
WCH25X9D	30	CROSSHEAD W/DT SMOOTH
WCH25X9K	30	CROSSHEAD W/KEY SMOOTH
WCH25X9T	30	CROSSHEAD W/TS SMOOTH

PART NUMBER	PAGE	DESCRIPTION
WCH25X10BT	30	CROSSHEAD W/BT SMOOTH
WCH26X9	30	CROSSHEAD SMOOTH
WCH26X9D	30	CROSSHEAD W/DT SMOOTH
WCH26X9K	30	CROSSHEAD W/KEY SMOOTH
WCH26X9T	30	CROSSHEAD W/TS SMOOTH
WCH26X10BT	30	CROSSHEAD W/BT SMOOTH
WCH27X9	30	CROSSHEAD SMOOTH
WCH27X9D	30	CROSSHEAD W/DT SMOOTH
WCH27X9K	30	CROSSHEAD W/KEY SMOOTH
WCH27X9T	30	CROSSHEAD W/TS SMOOTH
WCH27X10BT	30	CROSSHEAD W/BT SMOOTH
WCH28X9	30	CROSSHEAD SMOOTH
WCH28X9D	30	CROSSHEAD W/DT SMOOTH
WCH28X9K	30	CROSSHEAD W/KEY SMOOTH
WCH28X9T	30	CROSSHEAD W/TS SMOOTH
WCH28X10BT	30	CROSSHEAD W/BT SMOOTH
WCH29X9	30	CROSSHEAD SMOOTH
WCH29X9D	30	CROSSHEAD W/DT SMOOTH
WCH29X9K	30	CROSSHEAD W/KEY SMOOTH
WCH29X9T	30	CROSSHEAD W/TS SMOOTH
WCH29X10BT	30	CROSSHEAD W/BT SMOOTH
WCH30X9	30	CROSSHEAD SMOOTH
WCH30X9D	30	CROSSHEAD W/DT SMOOTH
WCH30X9K	30	CROSSHEAD W/KEY SMOOTH
WCH30X9T	30	CROSSHEAD W/TS SMOOTH
WCH30X10BT	30	CROSSHEAD W/BT SMOOTH
WCH32X9	30	CROSSHEAD SMOOTH
WCH32X9D	30	CROSSHEAD W/DT SMOOTH
WCH32X9K	30	CROSSHEAD W/KEY SMOOTH
WCH32X9T	30	CROSSHEAD W/TS SMOOTH
WCH32X10BT	30	CROSSHEAD W/BT SMOOTH
WCH33X9	30	CROSSHEAD SMOOTH
WCH33X9D	30	CROSSHEAD W/DT SMOOTH
WCH33X9K	30	CROSSHEAD W/KEY SMOOTH
WCH33X9T	30	CROSSHEAD W/TS SMOOTH
WCH33X10BT	30	CROSSHEAD W/BT SMOOTH
WCH34X9	30	CROSSHEAD SMOOTH
WCH34X9D	30	CROSSHEAD W/DT SMOOTH
WCH34X9K	30	CROSSHEAD W/KEY SMOOTH
WCH34X9T	30	CROSSHEAD W/TS SMOOTH
WCH34X10BT	30	CROSSHEAD W/BT SMOOTH
WCH35X9	30	CROSSHEAD SMOOTH
WCH35X9D	30	CROSSHEAD W/DT SMOOTH
WCH35X9K	30	CROSSHEAD W/KEY SMOOTH
WCH35X9T	30	CROSSHEAD W/TS SMOOTH
WCH35X10BT	30	CROSSHEAD W/BT SMOOTH

PART NUMBER	PAGE	DESCRIPTION
WCH36X9	30	CROSSHEAD SMOOTH
WCH36X9D	30	CROSSHEAD W/DT SMOOTH
WCH36X9K	30	CROSSHEAD W/KEY SMOOTH
WCH36X9T	30	CROSSHEAD W/TS SMOOTH
WCH36X10BT	30	CROSSHEAD W/BT SMOOTH
WCH37X9	30	CROSSHEAD SMOOTH
WCH37X9D	30	CROSSHEAD W/DT SMOOTH
WCH37X9K	30	CROSSHEAD W/KEY SMOOTH
WCH37X9T	30	CROSSHEAD W/TS SMOOTH
WCH37X10BT	30	CROSSHEAD W/BT SMOOTH
WCH38X9	30	CROSSHEAD SMOOTH
WCH38X9D	30	CROSSHEAD W/DT SMOOTH
WCH38X9K	30	CROSSHEAD W/KEY SMOOTH
WCH38X9T	30	CROSSHEAD W/TS SMOOTH
WCH38X10BT	30	CROSSHEAD W/BT SMOOTH
WCH40X9	30	CROSSHEAD SMOOTH
WCH40X9D	30	CROSSHEAD W/DT SMOOTH
WCH40X9K	30	CROSSHEAD W/KEY SMOOTH
WCH40X9T	30	CROSSHEAD W/TS SMOOTH
WCH40X10BT	30	CROSSHEAD W/BT SMOOTH
WCH41X9	30	CROSSHEAD SMOOTH
WCH41X9D	30	CROSSHEAD W/DT SMOOTH
WCH41X9K	30	CROSSHEAD W/KEY SMOOTH
WCH41X9T	30	CROSSHEAD W/TS SMOOTH
WCH41X10BT	30	CROSSHEAD W/BT SMOOTH
WCH42X9	30	CROSSHEAD SMOOTH
WCH42X9D	30	CROSSHEAD W/DT SMOOTH
WCH42X9K	30	CROSSHEAD W/KEY SMOOTH
WCH42X9T	30	CROSSHEAD W/TS SMOOTH
WCH42X10BT	30	CROSSHEAD W/BT SMOOTH
WCH43X9	30	CROSSHEAD SMOOTH
WCH43X9D	30	CROSSHEAD W/DT SMOOTH
WCH43X9K	30	CROSSHEAD W/KEY SMOOTH
WCH43X9T	30	CROSSHEAD W/TS SMOOTH
WCH43X10BT	30	CROSSHEAD W/BT SMOOTH
WCH44X9	30	CROSSHEAD SMOOTH
WCH44X9D	30	CROSSHEAD W/DT SMOOTH
WCH44X9K	30	CROSSHEAD W/KEY SMOOTH
WCH44X9T	30	CROSSHEAD W/TS SMOOTH
WCH44X10BT	30	CROSSHEAD W/BT SMOOTH
WCH45X9	30	CROSSHEAD SMOOTH
WCH45X9D	30	CROSSHEAD W/DT SMOOTH
WCH45X9K	30	CROSSHEAD W/KEY SMOOTH
WCH45X9T	30	CROSSHEAD W/TS SMOOTH
WCH45X10BT	30	CROSSHEAD W/BT SMOOTH
WCH46X9	30	CROSSHEAD SMOOTH

PART NUMBER	PAGE	DESCRIPTION
WCH46X9D	30	CROSSHEAD W/DT SMOOTH
WCH46X9K	30	CROSSHEAD W/KEY SMOOTH
WCH46X9T	30	CROSSHEAD W/TS SMOOTH
WCH46X10BT	30	CROSSHEAD W/BT SMOOTH
WCH48X9	30	CROSSHEAD SMOOTH
WCH48X9D	30	CROSSHEAD W/DT SMOOTH
WCH48X9K	30	CROSSHEAD W/KEY SMOOTH
WCH48X9T	30	CROSSHEAD W/TS SMOOTH
WCH48X10BT	30	CROSSHEAD W/BT SMOOTH
WCH49X9	30	CROSSHEAD SMOOTH
WCH49X9D	30	CROSSHEAD W/DT SMOOTH
WCH49X9K	30	CROSSHEAD W/KEY SMOOTH
WCH49X9T	30	CROSSHEAD W/TS SMOOTH
WCH49X10BT	30	CROSSHEAD W/BT SMOOTH
WCH50X9	30	CROSSHEAD SMOOTH
WCH50X9D	30	CROSSHEAD W/DT SMOOTH
WCH50X9K	30	CROSSHEAD W/KEY SMOOTH
WCH50X9T	30	CROSSHEAD W/TS SMOOTH
WCH50X10BT	30	CROSSHEAD W/BT SMOOTH
WCH54X9	30	CROSSHEAD SMOOTH
WCH54X9D	30	CROSSHEAD W/DT SMOOTH
WCH54X9K	30	CROSSHEAD W/KEY SMOOTH
WCH54X9T	30	CROSSHEAD W/TS SMOOTH
WCH54X10BT	30	CROSSHEAD W/BT SMOOTH
WCH56X9	30	CROSSHEAD SMOOTH
WCH56X9D	30	CROSSHEAD W/DT SMOOTH
WCH56X9K	30	CROSSHEAD W/KEY SMOOTH
WCH56X9T	30	CROSSHEAD W/TS SMOOTH
WCH56X10BT	30	CROSSHEAD W/BT SMOOTH
WCH58X9	30	CROSSHEAD SMOOTH
WCH58X9D	30	CROSSHEAD W/DT SMOOTH
WCH58X9K	30	CROSSHEAD W/KEY SMOOTH
WCH58X9T	30	CROSSHEAD W/TS SMOOTH
WCH58X10BT	30	CROSSHEAD W/BT SMOOTH
WCH60X9	30	CROSSHEAD SMOOTH
WCH60X9D	30	CROSSHEAD W/DT SMOOTH
WCH60X9K	30	CROSSHEAD W/KEY SMOOTH
WCH60X9T	30	CROSSHEAD W/TS SMOOTH
WCH60X10BT	30	CROSSHEAD W/BT SMOOTH
WCH62X9	30	CROSSHEAD SMOOTH
WCH62X9D	30	CROSSHEAD W/DT SMOOTH
WCH62X9K	30	CROSSHEAD W/KEY SMOOTH
WCH62X9T	30	CROSSHEAD W/TS SMOOTH
WCH62X10BT	30	CROSSHEAD W/BT SMOOTH
WCH64X9	30	CROSSHEAD SMOOTH
WCH64X9D	30	CROSSHEAD W/DT SMOOTH

PART NUMBER	PAGE	DESCRIPTION
WCH64X9K	30	CROSSHEAD W/KEY SMOOTH
WCH64X9T	30	CROSSHEAD W/TS SMOOTH
WCH64X10BT	30	CROSSHEAD W/BT SMOOTH
WCH65X9	30	CROSSHEAD SMOOTH
WCH65X9D	30	CROSSHEAD W/DT SMOOTH
WCH65X9K	30	CROSSHEAD W/KEY SMOOTH
WCH65X9T	30	CROSSHEAD W/TS SMOOTH
WCH65X10BT	30	CROSSHEAD W/BT SMOOTH
WCH66X9	30	CROSSHEAD SMOOTH
WCH66X9D	30	CROSSHEAD W/DT SMOOTH
WCH66X9K	30	CROSSHEAD W/KEY SMOOTH
WCH66X9T	30	CROSSHEAD W/TS SMOOTH
WCH66X10BT	30	CROSSHEAD W/BT SMOOTH
WCH67X9	30	CROSSHEAD SMOOTH
WCH67X9D	30	CROSSHEAD W/DT SMOOTH
WCH67X9K	30	CROSSHEAD W/KEY SMOOTH
WCH67X9T	30	CROSSHEAD W/TS SMOOTH
WCH67X10BT	30	CROSSHEAD W/BT SMOOTH
WCH68X9	30	CROSSHEAD SMOOTH
WCH68X9D	30	CROSSHEAD W/DT SMOOTH
WCH68X9K	30	CROSSHEAD W/KEY SMOOTH
WCH68X9T	30	CROSSHEAD W/TS SMOOTH
WCH68X10BT	30	CROSSHEAD W/BT SMOOTH
WCH69X9	30	CROSSHEAD SMOOTH
WCH69X9D	30	CROSSHEAD W/DT SMOOTH
WCH69X9K	30	CROSSHEAD W/KEY SMOOTH
WCH69X9T	30	CROSSHEAD W/TS SMOOTH
WCH69X10BT	30	CROSSHEAD W/BT SMOOTH
WCH70X9	30	CROSSHEAD SMOOTH
WCH70X9D	30	CROSSHEAD W/DT SMOOTH
WCH70X9K	30	CROSSHEAD W/KEY SMOOTH
WCH70X9T	30	CROSSHEAD W/TS SMOOTH
WCH70X10BT	30	CROSSHEAD W/BT SMOOTH
WCH72X9	30	CROSSHEAD SMOOTH
WCH72X9D	30	CROSSHEAD W/DT SMOOTH
WCH72X9K	30	CROSSHEAD W/KEY SMOOTH
WCH72X9T	30	CROSSHEAD W/TS SMOOTH
WCH72X10BT	30	CROSSHEAD W/BT SMOOTH
WCH73X9	30	CROSSHEAD SMOOTH
WCH73X9D	30	CROSSHEAD W/DT SMOOTH
WCH73X9K	30	CROSSHEAD W/KEY SMOOTH
WCH73X9T	30	CROSSHEAD W/TS SMOOTH
WCH73X10BT	30	CROSSHEAD W/BT SMOOTH
WCH74X9	30	CROSSHEAD SMOOTH
WCH74X9D	30	CROSSHEAD W/DT SMOOTH

PART NUMBER	PAGE	DESCRIPTION
WCH74X9K	30	CROSSHEAD W/KEY SMOOTH
WCH74X9T	30	CROSSHEAD W/TS SMOOTH
WCH74X10BT	30	CROSSHEAD W/BT SMOOTH
WCH75X9	30	CROSSHEAD SMOOTH
WCH75X9D	30	CROSSHEAD W/DT SMOOTH
WCH75X9K	30	CROSSHEAD W/KEY SMOOTH
WCH75X9T	30	CROSSHEAD W/TS SMOOTH
WCH75X10BT	30	CROSSHEAD W/BT SMOOTH
WCH76X9	30	CROSSHEAD SMOOTH
WCH76X9D	30	CROSSHEAD W/DT SMOOTH
WCH76X9K	30	CROSSHEAD W/KEY SMOOTH
WCH76X9T	30	CROSSHEAD W/TS SMOOTH
WCH76X10BT	30	CROSSHEAD W/BT SMOOTH
WCH77X9	30	CROSSHEAD SMOOTH
WCH77X9D	30	CROSSHEAD W/DT SMOOTH
WCH77X9K	30	CROSSHEAD W/KEY SMOOTH
WCH77X9T	30	CROSSHEAD W/TS SMOOTH
WCH77X10BT	30	CROSSHEAD W/BT SMOOTH
WCH78X9	30	CROSSHEAD SMOOTH
WCH78X9D	30	CROSSHEAD W/DT SMOOTH
WCH78X9K	30	CROSSHEAD W/KEY SMOOTH
WCH78X9T	30	CROSSHEAD W/TS SMOOTH
WCH78X10BT	30	CROSSHEAD W/BT SMOOTH
WCH80X9	30	CROSSHEAD SMOOTH
WCH80X9D	30	CROSSHEAD W/DT SMOOTH
WCH80X9K	30	CROSSHEAD W/KEY SMOOTH
WCH80X9T	30	CROSSHEAD W/TS SMOOTH
WCH80X10BT	30	CROSSHEAD W/BT SMOOTH
WCH81X9	30	CROSSHEAD SMOOTH
WCH81X9D	30	CROSSHEAD W/DT SMOOTH
WCH81X9K	30	CROSSHEAD W/KEY SMOOTH
WCH81X9T	30	CROSSHEAD W/TS SMOOTH
WCH81X10BT	30	CROSSHEAD W/BT SMOOTH
WCH82X9	30	CROSSHEAD SMOOTH
WCH82X9D	30	CROSSHEAD W/DT SMOOTH
WCH82X9K	30	CROSSHEAD W/KEY SMOOTH
WCH82X9T	30	CROSSHEAD W/TS SMOOTH
WCH82X10BT	30	CROSSHEAD W/BT SMOOTH
WCH84X9	30	CROSSHEAD SMOOTH
WCH84X9D	30	CROSSHEAD W/DT SMOOTH
WCH84X9K	30	CROSSHEAD W/KEY SMOOTH
WCH84X9T	30	CROSSHEAD W/TS SMOOTH
WCH84X10BT	30	CROSSHEAD W/BT SMOOTH
WCH85X9	30	CROSSHEAD SMOOTH
WCH85X9D	30	CROSSHEAD W/DT SMOOTH



PART NUMBER	PAGE	DESCRIPTION
WCH85X9K	30	CROSSHEAD W/KEY SMOOTH
WCH85X9T	30	CROSSHEAD W/TS SMOOTH
WCH85X10BT	30	CROSSHEAD W/BT SMOOTH
WCH86X9	30	CROSSHEAD SMOOTH
WCH86X9D	30	CROSSHEAD W/DT SMOOTH
WCH86X9K	30	CROSSHEAD W/KEY SMOOTH
WCH86X9T	30	CROSSHEAD W/TS SMOOTH
WCH86X10BT	30	CROSSHEAD W/BT SMOOTH
WCH88X9	30	CROSSHEAD SMOOTH
WCH88X9D	30	CROSSHEAD W/DT SMOOTH
WCH88X9K	30	CROSSHEAD W/KEY SMOOTH
WCH88X9T	30	CROSSHEAD W/TS SMOOTH
WCH88X10BT	30	CROSSHEAD W/BT SMOOTH
WCH90X9	30	CROSSHEAD SMOOTH
WCH90X9D	30	CROSSHEAD W/DT SMOOTH
WCH90X9K	30	CROSSHEAD W/KEY SMOOTH
WCH90X9T	30	CROSSHEAD W/TS SMOOTH
WCH90X10BT	30	CROSSHEAD W/BT SMOOTH
WCH93X9	31	CROSSHEAD SMOOTH
WCH93X9D	31	CROSSHEAD W/DT SMOOTH
WCH93X9K	31	CROSSHEAD W/KEY SMOOTH
WCH93X9T	31	CROSSHEAD W/TS SMOOTH
WCH93X10BT	31	CROSSHEAD W/BT SMOOTH
WCH96X9	31	CROSSHEAD SMOOTH
WCH96X9D	31	CROSSHEAD W/DT SMOOTH
WCH96X9K	31	CROSSHEAD W/KEY SMOOTH
WCH96X9T	31	CROSSHEAD W/TS SMOOTH
WCH96X10BT	31	CROSSHEAD W/BT SMOOTH
WCH99X9	31	CROSSHEAD SMOOTH
WCH99X9D	31	CROSSHEAD W/DT SMOOTH
WCH99X9K	31	CROSSHEAD W/KEY SMOOTH
WCH99X9T	31	CROSSHEAD W/TS SMOOTH
WCH99X10BT	31	CROSSHEAD W/BT SMOOTH
WCH100X9	31	CROSSHEAD SMOOTH
WCH100X9D	31	CROSSHEAD W/DT SMOOTH
WCH100X9K	31	CROSSHEAD W/KEY SMOOTH
WCH100X9T	31	CROSSHEAD W/TS SMOOTH
WCH100X10BT	31	CROSSHEAD W/BT SMOOTH
WCH101X9	31	CROSSHEAD SMOOTH
WCH101X9D	31	CROSSHEAD W/DT SMOOTH
WCH101X9K	31	CROSSHEAD W/KEY SMOOTH
WCH101X9T	31	CROSSHEAD W/TS SMOOTH
WCH101X10BT	31	CROSSHEAD W/BT SMOOTH
WCH103X9	31	CROSSHEAD SMOOTH
WCH103X9D	31	CROSSHEAD W/DT SMOOTH

PART NUMBER	PAGE	DESCRIPTION
WCH103X9K	31	CROSSHEAD W/KEY SMOOTH
WCH103X9T	31	CROSSHEAD W/TS SMOOTH
WCH103X10BT	31	CROSSHEAD W/BT SMOOTH
WCH104X9	31	CROSSHEAD SMOOTH
WCH104X9D	31	CROSSHEAD W/DT SMOOTH
WCH104X9K	31	CROSSHEAD W/KEY SMOOTH
WCH104X9T	31	CROSSHEAD W/TS SMOOTH
WCH104X10BT	31	CROSSHEAD W/BT SMOOTH
WCH108X9	31	CROSSHEAD SMOOTH
WCH108X9D	31	CROSSHEAD W/DT SMOOTH
WCH108X9K	31	CROSSHEAD W/KEY SMOOTH
WCH108X9T	31	CROSSHEAD W/TS SMOOTH
WCH108X10BT	31	CROSSHEAD W/BT SMOOTH
WCH110X9	31	CROSSHEAD SMOOTH
WCH110X9D	31	CROSSHEAD W/DT SMOOTH
WCH110X9K	31	CROSSHEAD W/KEY SMOOTH
WCH110X9T	31	CROSSHEAD W/TS SMOOTH
WCH110X10BT	31	CROSSHEAD W/BT SMOOTH
WCH112X9	31	CROSSHEAD SMOOTH
WCH112X9D	31	CROSSHEAD W/DT SMOOTH
WCH112X9K	31	CROSSHEAD W/KEY SMOOTH
WCH112X9T	31	CROSSHEAD W/TS SMOOTH
WCH112X10BT	31	CROSSHEAD W/BT SMOOTH
WCH113X9	31	CROSSHEAD SMOOTH
WCH113X9D	31	CROSSHEAD W/DT SMOOTH
WCH113X9K	31	CROSSHEAD W/KEY SMOOTH
WCH113X9T	31	CROSSHEAD W/TS SMOOTH
WCH113X10BT	31	CROSSHEAD W/BT SMOOTH
WCH120X9	31	CROSSHEAD SMOOTH
WCH120X9D	31	CROSSHEAD W/DT SMOOTH
WCH120X9K	31	CROSSHEAD W/KEY SMOOTH
WCH120X9T	31	CROSSHEAD W/TS SMOOTH
WCH120X10BT	31	CROSSHEAD W/BT SMOOTH
WCH124X9	31	CROSSHEAD SMOOTH
WCH124X9D	31	CROSSHEAD W/DT SMOOTH
WCH124X9K	31	CROSSHEAD W/KEY SMOOTH
WCH124X9T	31	CROSSHEAD W/TS SMOOTH
WCH124X10BT	31	CROSSHEAD W/BT SMOOTH
WCH144X9	31	CROSSHEAD SMOOTH
WCH144X9D	31	CROSSHEAD W/DT SMOOTH
WCH144X9K	31	CROSSHEAD W/KEY SMOOTH
WCH144X9T	31	CROSSHEAD W/TS SMOOTH
WCH144X10BT	31	CROSSHEAD W/BT SMOOTH
WCH192X9	31	CROSSHEAD SMOOTH
WCH192X9D	31	CROSSHEAD W/DT SMOOTH

PART NUMBER	PAGE	DESCRIPTION
WCH192X9K	31	CROSSHEAD W/KEY SMOOTH
WCH192X9T	31	CROSSHEAD W/TS SMOOTH
WCH192X10BT	31	CROSSHEAD W/BT SMOOTH
WCH196X9	31	CROSSHEAD SMOOTH
WCH196X9D	31	CROSSHEAD W/DT SMOOTH
WCH196X9K	31	CROSSHEAD W/KEY SMOOTH
WCH196X9T	31	CROSSHEAD W/TS SMOOTH
WCH196X10BT	31	CROSSHEAD W/BT SMOOTH
WCH197X9	31	CROSSHEAD SMOOTH
WCH197X9D	31	CROSSHEAD W/DT SMOOTH
WCH197X9K	31	CROSSHEAD W/KEY SMOOTH
WCH197X9T	31	CROSSHEAD W/TS SMOOTH
WCH197X10BT	31	CROSSHEAD W/BT SMOOTH
WCH200X9	31	CROSSHEAD SMOOTH
WCH200X9D	31	CROSSHEAD W/DT SMOOTH
WCH200X9K	31	CROSSHEAD W/KEY SMOOTH
WCH200X9T	31	CROSSHEAD W/TS SMOOTH
WCH200X10BT	31	CROSSHEAD W/BT SMOOTH
WCH204X9	31	CROSSHEAD SMOOTH
WCH204X9D	31	CROSSHEAD W/DT SMOOTH
WCH204X9K	31	CROSSHEAD W/KEY SMOOTH
WCH204X9T	31	CROSSHEAD W/TS SMOOTH
WCH204X10BT	31	CROSSHEAD W/BT SMOOTH
WCH207X9	31	CROSSHEAD SMOOTH
WCH207X9D	31	CROSSHEAD W/DT SMOOTH
WCH207X9K	31	CROSSHEAD W/KEY SMOOTH
WCH207X9T	31	CROSSHEAD W/TS SMOOTH
WCH207X10BT	31	CROSSHEAD W/BT SMOOTH
<b>12" CROSSHEAD</b>		
WCH36X12	33	CROSSHEAD SMOOTH
WCH36X12D	33	CROSSHEAD W/DT SMOOTH
WCH36X12K	33	CROSSHEAD W/KEY SMOOTH
WCH36X12T	33	CROSSHEAD W/TS SMOOTH
WCH36X13BT	33	CROSSHEAD W/BT SMOOTH
WCH37X12	33	CROSSHEAD SMOOTH
WCH37X12D	33	CROSSHEAD W/DT SMOOTH
WCH37X12K	33	CROSSHEAD W/KEY SMOOTH
WCH37X12T	33	CROSSHEAD W/TS SMOOTH
WCH37X13BT	33	CROSSHEAD W/BT SMOOTH
WCH40X12	33	CROSSHEAD SMOOTH
WCH40X12D	33	CROSSHEAD W/DT SMOOTH
WCH40X12K	33	CROSSHEAD W/KEY SMOOTH
WCH40X12T	33	CROSSHEAD W/TS SMOOTH
WCH40X13BT	33	CROSSHEAD W/BT SMOOTH
WCH44X12	33	CROSSHEAD SMOOTH
WCH44X12D	33	CROSSHEAD W/DT SMOOTH

PART NUMBER	PAGE	DESCRIPTION
WCH44X12K	33	CROSSHEAD W/KEY SMOOTH
WCH44X12T	33	CROSSHEAD W/TS SMOOTH
WCH44X13BT	33	CROSSHEAD W/BT SMOOTH
WCH48X12	33	CROSSHEAD SMOOTH
WCH48X12D	33	CROSSHEAD W/DT SMOOTH
WCH48X12K	33	CROSSHEAD W/KEY SMOOTH
WCH48X12T	33	CROSSHEAD W/TS SMOOTH
WCH48X13BT	33	CROSSHEAD W/BT SMOOTH
WCH54X12	33	CROSSHEAD SMOOTH
WCH54X12D	33	CROSSHEAD W/DT SMOOTH
WCH54X12K	33	CROSSHEAD W/KEY SMOOTH
WCH54X12T	33	CROSSHEAD W/TS SMOOTH
WCH54X13BT	33	CROSSHEAD W/BT SMOOTH
WCH56X12	33	CROSSHEAD SMOOTH
WCH56X12D	33	CROSSHEAD W/DT SMOOTH
WCH56X12K	33	CROSSHEAD W/KEY SMOOTH
WCH56X12T	33	CROSSHEAD W/TS SMOOTH
WCH56X13BT	33	CROSSHEAD W/BT SMOOTH
WCH64X12	33	CROSSHEAD SMOOTH
WCH64X12D	33	CROSSHEAD W/DT SMOOTH
WCH64X12K	33	CROSSHEAD W/KEY SMOOTH
WCH64X12T	33	CROSSHEAD W/TS SMOOTH
WCH64X13BT	33	CROSSHEAD W/BT SMOOTH
WCH72X12	33	CROSSHEAD SMOOTH
WCH72X12D	33	CROSSHEAD W/DT SMOOTH
WCH72X12K	33	CROSSHEAD W/KEY SMOOTH
WCH72X12T	33	CROSSHEAD W/TS SMOOTH
WCH72X13BT	33	CROSSHEAD W/BT SMOOTH
WCH96X12	33	CROSSHEAD SMOOTH
WCH96X12D	33	CROSSHEAD W/DT SMOOTH
WCH96X12K	33	CROSSHEAD W/KEY SMOOTH
WCH96X12T	33	CROSSHEAD W/TS SMOOTH
WCH96X13BT	33	CROSSHEAD W/BT SMOOTH
WCH102X12	33	CROSSHEAD SMOOTH
WCH102X12D	33	CROSSHEAD W/DT SMOOTH
WCH102X12K	33	CROSSHEAD W/KEY SMOOTH
WCH102X12T	33	CROSSHEAD W/TS SMOOTH
WCH102X13BT	33	CROSSHEAD W/BT SMOOTH
WCH104X12	33	CROSSHEAD SMOOTH
WCH104X12D	33	CROSSHEAD W/DT SMOOTH
WCH104X12K	33	CROSSHEAD W/KEY SMOOTH
WCH104X12T	33	CROSSHEAD W/TS SMOOTH
WCH104X13BT	33	CROSSHEAD W/BT SMOOTH
WCH144X12	33	CROSSHEAD SMOOTH
WCH144X12D	33	CROSSHEAD W/DT SMOOTH
WCH144X12K	33	CROSSHEAD W/KEY SMOOTH

PART NUMBER	PAGE	DESCRIPTION
WCH144X12T	33	CROSSHEAD W/TS SMOOTH
WCH144X13BT	33	CROSSHEAD W/BT SMOOTH
WCH200X12	33	CROSSHEAD SMOOTH
WCH200X12D	33	CROSSHEAD W/DT SMOOTH
WCH200X12K	33	CROSSHEAD W/KEY SMOOTH
WCH200X12T	33	CROSSHEAD W/TS SMOOTH
WCH200X13BT	33	CROSSHEAD W/BT SMOOTH
WCH203X12	33	CROSSHEAD SMOOTH
WCH203X12D	33	CROSSHEAD W/DT SMOOTH
WCH203X12K	33	CROSSHEAD W/KEY SMOOTH
WCH203X12T	33	CROSSHEAD W/TS SMOOTH
WCH203X13BT	33	CROSSHEAD W/BT SMOOTH
WCH213X12	33	CROSSHEAD SMOOTH
WCH213X12D	33	CROSSHEAD W/DT SMOOTH
WCH213X12K	33	CROSSHEAD W/KEY SMOOTH
WCH213X12T	33	CROSSHEAD W/TS SMOOTH
WCH213X13BT	33	CROSSHEAD W/BT SMOOTH
<b>ARCH CROSSHEAD</b>		
WCH6ARS34X10	34	ARCHED CROSSHEAD SMOOTH
WCH6ARS34X10K	34	ARCHED CROSSHEAD W/KEY SMOOTH
WCHARS101X13	34	ARCHED CROSSHEAD SMOOTH
WCHARS101X13K	34	ARCHED CROSSHEAD W/KEY SMOOTH
WCHARS101X14BT	34	ARCHED CROSSHEAD W/BT SMOOTH
WCHARS108X19	34	ARCHED CROSSHEAD SMOOTH
WCHARS108X19K	34	ARCHED CROSSHEAD W/KEY SMOOTH
WCHARS108X20BT	34	ARCHED CROSSHEAD W/BT SMOOTH
WCHARS33X14	34	ARCHED CROSSHEAD SMOOTH
WCHARS33X14K	34	ARCHED CROSSHEAD W/KEY SMOOTH
WCHARS33X15BT	34	ARCHED CROSSHEAD W/BT SMOOTH
WCHARS36X13	34	ARCHED CROSSHEAD SMOOTH
WCHARS36X13K	34	ARCHED CROSSHEAD W/KEY SMOOTH
WCHARS36X14BT	34	ARCHED CROSSHEAD W/BT SMOOTH
WCHARS43X13	34	ARCHED CROSSHEAD SMOOTH
WCHARS43X13K	34	ARCHED CROSSHEAD W/KEY SMOOTH
WCHARS43X14BT	34	ARCHED CROSSHEAD W/BT SMOOTH
WCHARS54X16	34	ARCHED CROSSHEAD SMOOTH
WCHARS54X16K	34	ARCHED CROSSHEAD W/KEY SMOOTH
WCHARS54X17BT	34	ARCHED CROSSHEAD W/BT SMOOTH
WCHARS64X14	34	ARCHED CROSSHEAD SMOOTH
WCHARS64X14K	34	ARCHED CROSSHEAD W/KEY SMOOTH
WCHARS64X15BT	34	ARCHED CROSSHEAD W/BT SMOOTH
WCHARS68X12	34	ARCHED CROSSHEAD SMOOTH
WCHARS68X12K	34	ARCHED CROSSHEAD W/KEY SMOOTH
WCHARS68X13BT	34	ARCHED CROSSHEAD W/BT SMOOTH
WCHARS68X16	34	ARCHED CROSSHEAD SMOOTH
WCHARS68X16K	34	ARCHED CROSSHEAD W/KEY SMOOTH

PART NUMBER	PAGE	DESCRIPTION
WCHARS68X17BT	34	ARCHED CROSSHEAD W/BT SMOOTH
WCHARS72X13	34	ARCHED CROSSHEAD SMOOTH
WCHARS72X13K	34	ARCHED CROSSHEAD W/KEY SMOOTH
WCHARS72X14BT	34	ARCHED CROSSHEAD W/BT SMOOTH
WCHARS75X13	34	ARCHED CROSSHEAD SMOOTH
WCHARS75X13K	34	ARCHED CROSSHEAD W/KEY SMOOTH
WCHARS75X14BT	34	ARCHED CROSSHEAD W/BT SMOOTH
WCHARS80X15	34	ARCHED CROSSHEAD SMOOTH
WCHARS80X15K	34	ARCHED CROSSHEAD W/KEY SMOOTH
WCHARS80X16BT	34	ARCHED CROSSHEAD W/BT SMOOTH
WCHARS84X16	34	ARCHED CROSSHEAD SMOOTH
WCHARS84X16K	34	ARCHED CROSSHEAD W/KEY SMOOTH
WCHARS84X17BT	34	ARCHED CROSSHEAD W/BT SMOOTH
WCHARS89X13	34	ARCHED CROSSHEAD SMOOTH
WCHARS89X13K	34	ARCHED CROSSHEAD W/KEY SMOOTH
WCHARS89X14BT	34	ARCHED CROSSHEAD W/BT SMOOTH
WCHARS97X17	34	ARCHED CROSSHEAD SMOOTH
WCHARS97X17K	34	ARCHED CROSSHEAD W/KEY SMOOTH
WCHARS97X18BT	34	ARCHED CROSSHEAD W/BT SMOOTH
<b>SEGMENTED CROSSHEAD</b>		
WCHSEG28X10	35	EYEBROW CROSSHEAD SMOOTH
WCHSEG28X10K	35	EYEBROW CROSSHEAD W/KEY SMOOTH
WCHSEG28X11BT	35	EYEBROW CROSSHEAD W/BT SMOOTH
WCHSEG30X10	35	EYEBROW CROSSHEAD SMOOTH
WCHSEG30X10K	35	EYEBROW CROSSHEAD W/KEY SMOOTH
WCHSEG30X11BT	35	EYEBROW CROSSHEAD W/BT SMOOTH
WCHSEG34X10	35	EYEBROW CROSSHEAD SMOOTH
WCHSEG34X10K	35	EYEBROW CROSSHEAD W/KEY SMOOTH
WCHSEG34X11BT	35	EYEBROW CROSSHEAD W/BT SMOOTH
WCHSEG36X10	35	EYEBROW CROSSHEAD SMOOTH
WCHSEG36X10K	35	EYEBROW CROSSHEAD W/KEY SMOOTH
WCHSEG36X11BT	35	EYEBROW CROSSHEAD W/BT SMOOTH
WCHSEG43X10	35	EYEBROW CROSSHEAD SMOOTH
WCHSEG43X10K	35	EYEBROW CROSSHEAD W/KEY SMOOTH
WCHSEG43X11BT	35	EYEBROW CROSSHEAD W/BT SMOOTH
WCHSEG44X10	35	EYEBROW CROSSHEAD SMOOTH
WCHSEG44X10K	35	EYEBROW CROSSHEAD W/KEY SMOOTH
WCHSEG44X11BT	35	EYEBROW CROSSHEAD W/BT SMOOTH
WCHSEG64X10	35	EYEBROW CROSSHEAD SMOOTH
WCHSEG64X10K	35	EYEBROW CROSSHEAD W/KEY SMOOTH
WCHSEG64X11BT	35	EYEBROW CROSSHEAD W/BT SMOOTH
WCHSEG72X10	35	EYEBROW CROSSHEAD SMOOTH
WCHSEG72X10K	35	EYEBROW CROSSHEAD W/KEY SMOOTH
WCHSEG72X11BT	35	EYEBROW CROSSHEAD W/BT SMOOTH
WDP36X18	54	WINDOW PANEL RAISED SMOOTH
WDP48X73F	54	WINDOW PANEL FLAT SMOOTH



# FYPON



1750 Indian Wood Circle | Maumee, OH 43537 | Phone: 800.446.3040 U.S. and Canada  
Fax: 800.446.9373 U.S. and Canada | [fypon.com](http://fypon.com) | [info@fypon.com](mailto:info@fypon.com)



Fypon warrants all of our products to be free from defects in material and workmanship for as long as the original owner of the residential dwelling owns the property. For complete homeowner lifetime limited warranty details, exclusions and limitations, please see your purchase location or visit [fypon.com](http://fypon.com).

©2020 Fypon, LLC. All rights reserved. Fypon and the Fypon Logo are trademarks of Fypon, LLC. Fypon, LLC, and its parent company Therma-Tru Corp. are part of Fortune Brands Home & Security, Inc. All trademarks are property of their respective owners. Loctite® PL Premium® is owned by Henkel IP & Holding GmbH.

Publication No. MAFYFLCAT2020 HESS / NOV2019