



FAIRWAY

ARCHITECTURAL RAILING SOLUTIONS



FAIRWAY

ARCHITECTURAL RAILING SOLUTIONS



New for 2020!



A210 3-Rail
Kits
~~30~~

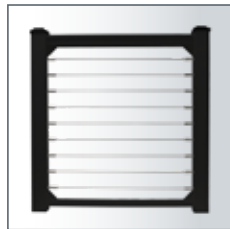

A210 Gate -
Horizontal Cable
~~36~~

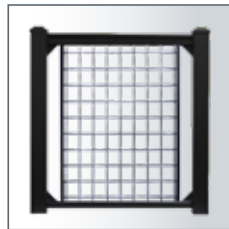

P300 / A210 / A310
Gates - Mesh Panel
~~17~~
P300

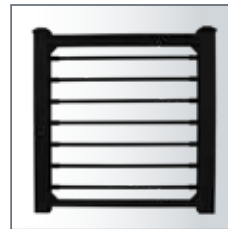

P300 / A210 / A310
Gates - Horizontal Baluster
~~36~~
A210
~~51~~
A310



CP310 Square
Balusters
~~120~~



Infill Railing Systems -
Horizontal Baluster, Mesh Panel & Steel Baluster
~~145~~



Standard Structural Post
Now with a Square Post!
**RAILING
ACCESSORIES**



S110 Cup & Cover
Bracket
~~26~~



A210 Flanged Post Kits -
Includes Cap & Trim
~~37~~

Fairway Architectural Railing Solutions have been tested to the prevailing ICC (International Code Council) AC-174 (Acceptance Criteria) standards and requirements for both IRC (Residential) and IBC (Commercial) applications, as certified by an IAS recognized and ANSI certified laboratory, and those current and applicable reports, including any limitations, may be viewed by visiting www.archtest.com.

Fairway Architectural Railing Solutions is not responsible for typographical errors. Pricing subject to change. Always check with your local building code before starting any project and follow all safety precautions. Visual representations may vary from actual colors.



0/4 CELLULAR PVC RAILING

P300 Railing Kits	
P310	4
P315 For Deck Board	10
P300 Series Accessories	16

2/4 STEEL RAILING

S100 Railing Kits	
S110	24
S110 Accessories	26

2/7 ALUMINUM RAILING

A200 Railing Kits	
A210	27
A210 Accessories	35
A300 Railing Kits	
A310	43
A310 Accessories	50

5/9 VINYL RAILING

V100 Railing Kits	
V110	59
V100 Accessories	63
V200 Railing Kits	
V210	67
V210 Accessories	72
V215 For Deck Board	75
V215 Accessories	78
V220	81
V220 Accessories	86
V400 Railing Kits	
V410	89
V410 Accessories	91
V500 Railing Kits	
V510	92
V510 Accessories	94

9/5 VINYL POST ACCESSORIES

Structural Post Mounts	96
Post Sleeves	97
Post Wraps	98
Newel Posts	99
Post Caps	100
Post Cap Accents	102
Post Accents	103
Post Trim	104
Porch Posts & Columns	106
Pergola	111
Vinyl Fence	113

11/9 COMPOSITE RAILING

CP300 Railing Kits	
CP310	119
CP315 For Deck Board	122
CP300 Accessories	125

13/1 HORIZONTAL CABLE 131

INFILL RAILING SYSTEMS 145

LED LIGHTING 148

ADA HANDRAILING 151

Vinyl	152
Aluminum	154

ITEM NUMBER INDEX 156

Can't Find What You're Looking For? Contact Us!

With over 7,000 railing components to choose from, chances are we have what you need.

Get in touch with one of our railing experts at **1-800-598-5245** and we'll be happy to assist you.





P310

SERIES

CELLULAR PVC RAILING

RAILING COLOR

White**



FEATURES & BENEFITS

- 100% Extruded Cellular PVC Reinforced With Aluminum In Both Top & Bottom Rails
- Classic, Refined Profile - Won't Compromise Your View
- Dimensionally Stable - Won't Twist, Rot Or Splinter
- Hidden Mounting Brackets
- Level Top & Bottom Rails Are Machined For Square CPVC Balusters
- Soft Matte Finish Minimizes Glare & Surface Blemishes
- Impenetrable To Moisture - Mold & Mildew Resistant
- Two-Piece Top Rail - Ideal For In-Rail LED Lighting
- Customize It With Paint - Readily Accepts & Holds Any Paint Color With An LRV Greater Than 55**

INFILL OPTIONS

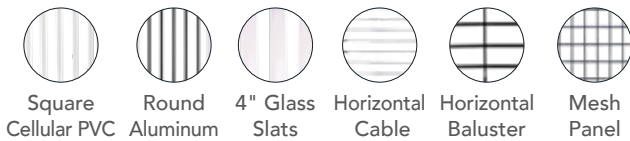

RAILING HEIGHTS

36" Residential • 42" Commercial
Meets IRC, IBC Standards

RAILING LENGTHS*

6', 8', 10' Level • 6', 8' Stair
Aluminum Reinforced Top & Bottom Rail

KITS INCLUDE

Top Rail, Sub-Rail & Bottom Rails, Balusters/Infill, Mounting Brackets & Hardware

Limited Lifetime Warranty

** Available Lengths Depend On Choice Of Infill.*

**** Product may be painted. If you choose to paint the P300 Series cellular PVC railing, we recommend you use a premium grade acrylic paint with solar reflective pigment and one specifically for use with PVC products. Due to the expansion and contraction characteristics of PVC, P300 Series products should only be painted colors with an LRV (Light Reflective Value) greater than 55. The use of darker colors may cause damage due to excessive expansion or contraction and will void the product warranty.**

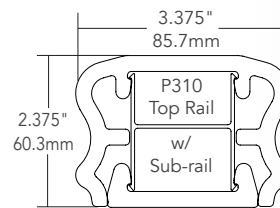

Top Rail w/ Sub-rail

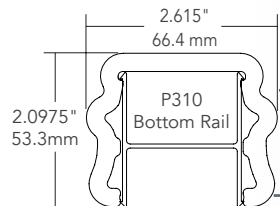

Bottom Rail

**SQUARE CPVC BALUSTERS:
STAIR TOP RAIL IS PRE-ROUTED WHILE
THE BOTTOM RAIL REQUIRES SCREWS**

P310 Cellular PVC Railing Kits



KIT INCLUDES:

- Top Rail w/ Aluminum Insert
 - Top Sub-Rail
 - Bottom Rail w/ Aluminum Insert
 - Square CPVC Balusters
 - Rail Support
 - Mounting Brackets w/Screws
- Post, Caps and Trim Sold Separately

RECOMMENDED POST LENGTH PURCHASE

36" w/Square Balusters = 39"

42" w/Square Balusters = 48"

Bottom of stair posts will require additional post length to cover riser - typical 7" - 8"

PLEASE NOTE: When mixing square baluster kits with optional glass or aluminum balusters overall finish rail height will vary requiring the purchase of 42" square baluster kits.

Square Cellular Baluster Kits - LEVEL

Height	Length	White
36"	6'	500500 \$216.97
36"	8'	500510 \$289.31
36"	10'	500520 \$361.61
42"	6'	500550 \$249.52
42"	8'	500560 \$332.69
42"	10'	500570 \$415.86

Square Cellular Baluster Kits - STAIR 29°- 41°

Height	Length	White
36"	6'	500505 \$216.97
36"	8'	500515 \$289.31
42"	6'	500555 \$249.52
42"	8'	500565 \$332.69



KIT INCLUDES:

- Top Rail w/ Aluminum Insert
- Top Sub-Rail
- Bottom Rail w/ Aluminum Insert
- 4" Tempered Glass Slats
- Glass Baluster Shoes
- Rail Support
- Mounting Brackets w/Screws

RECOMMENDED POST LENGTH PURCHASE

36" w/Glass Balusters = 48"

42" w/Glass Balusters = 48"

Bottom of stair posts will require additional post length to cover riser - typical 7" - 8"

PLEASE NOTE: When mixing square baluster kits with optional glass or aluminum balusters overall finish rail height will vary requiring the purchase of 42" square baluster kits.

4" Glass Slat Kits - LEVEL

Height	Length	White
36"	6'	500700 \$443.58
36"	8'	500710 \$591.45
42"	6'	500750 \$510.13
42"	8'	500760 \$680.17

4" Glass Slat Kits - STAIR 30°- 34°

Height	Length	White
36"	6'	500705 \$443.58
36"	8'	500715 \$591.45
42"	6'	500755 \$510.13
42"	8'	500765 \$680.17

P310 Cellular PVC Railing Kits



KIT INCLUDES:

- Top Rail w/ Aluminum Insert
- Top Sub-Rail
- Bottom Rail w/ Aluminum Insert
- Round Aluminum Balusters
- Rail Support
- 3/4" Round Baluster Connectors
- Mounting Brackets w/Screws

Post, Caps and Trim Sold Separately

RECOMMENDED POST LENGTH PURCHASE

36" w/Aluminum Balusters = 48"
 42" w/Aluminum Balusters = 48"

Bottom of stair posts will require additional post length to cover riser - typical 7" - 8"

PLEASE NOTE: When mixing square baluster kits with optional glass or aluminum balusters overall finish rail height will vary requiring the purchase of 42" square baluster kits.

Round Aluminum Baluster Kits - LEVEL

Height	Length	White
36"	6'	500600(B) \$255.19
36"	8'	500610(B) \$340.26
36"	10'	500620(B) \$425.32
42"	6'	500650(B) \$293.49
42"	8'	500660(B) \$391.30
42"	10'	500670(B) \$489.15

Round Aluminum Baluster Kits - STAIR 30°- 37°

Height	Length	White
36"	6'	500605(B) \$255.19
36"	8'	500615(B) \$340.26
42"	6'	500655(B) \$293.49
42"	8'	500665(B) \$391.30

Round Aluminum Baluster Kits ship with black balusters. To receive balusters in the color of your choice, replace (B) in item number with the color letter shown.

- Bronze
(Z)
- Hammered
Bronze - (H)
- Clay
(C)
- Rust
(R)
- Green
(G)
- White
(W)



KIT INCLUDES:

- Top Rail w/ Aluminum Insert
- Blank Top Sub-Rail
- Blank Bottom Rail w/ Aluminum Insert
- Rail Support
- Mounting Brackets w/Screws

Posts, Caps, Trim and Horizontal Cable Infill Sold Separately

P310 - Cable Infill Rail Kits - LEVEL

Height	Length	White
36" & 42"	6'	202000 \$144.24
36" & 42"	8'	202010 \$213.13

P310 - Cable Infill Rail Kits - STAIR

Height	Length	White
36" & 42"	6'	202005 \$144.24
36" & 42"	8'	202015 \$213.13

SEE PAGES 143 & 144 FOR ALL HORIZONTAL CABLE COMPONENTS AND ACCESSORIES NOT INCLUDED IN KIT.

P310 Cellular PVC Railing Kits



KIT INCLUDES:

- Top Rail w/ Aluminum Insert
- Top Sub-Rail
- Bottom Rail w/ Aluminum Insert
- Intermediate Baluster
- 5/8" Round Aluminum Balusters w/ Brackets
- Mounting Brackets w/Screws
- Rail Support

Post, Caps and Trim Sold Separately

PLEASE NOTE: Horizontal Baluster Stair Adapters are available for level angle installations. See page 23 for details.

Anodized Horizontal Baluster Kits - LEVEL - WITH BOTTOM RAIL

Height	Length	White
36"	6'	207100A \$502.00
36"	8'	207101A \$669.33
42"	6'	207150A \$577.30
42"	8'	207151A \$769.73

Anodized Horizontal Baluster Kits - STAIR - WITH BOTTOM RAIL

Height	Length	White
36"	6'	207102A \$621.35
36"	8'	207103A \$805.04
42"	6'	207152A \$727.43
42"	8'	207153A \$938.67

CUSTOM PROJECT?

Horizontal Baluster Infill Kits are available for aluminum, vinyl, composite and wood railing. See page 146 for details.



KIT INCLUDES:

- Top Rail w/ Aluminum Insert
- Top Sub-Rail
- Bottom Rail w/ Aluminum Insert
- Intermediate Baluster
- 5/8" Round Aluminum Balusters w/ Brackets
- Mounting Brackets w/Screws
- Rail Support

Post, Caps and Trim Sold Separately

PLEASE NOTE: Horizontal Baluster Stair Adapters are available for level angle installations. See page 23 for details.

Black Horizontal Baluster Kits - LEVEL - WITH BOTTOM RAIL

Height	Length	White
36"	6'	207100B \$502.00
36"	8'	207101B \$669.33
42"	6'	207150B \$577.30
42"	8'	207151B \$769.73

Black Horizontal Baluster Kits - STAIR - WITH BOTTOM RAIL

Height	Length	White
36"	6'	207102B \$621.35
36"	8'	207103B \$805.04
42"	6'	207152B \$727.43
42"	8'	207153B \$938.67

CUSTOM PROJECT?

Horizontal Baluster Infill Kits are available for aluminum, vinyl, composite and wood railing. See page 146 for details.

P310 Cellular PVC Railing Kits



KIT INCLUDES:

- Top Rail w/ Aluminum Insert
- Top Sub-Rail
- Intermediate Baluster
- 5/8" Round Aluminum Balusters w/ Brackets
- Mounting Brackets w/Screws
- Rail Support

Post, Caps and Trim Sold Separately

PLEASE NOTE: Horizontal Baluster Stair Adapters are available for level angle installations. See page 23 for details.

Anodized Horizontal Baluster Kits - LEVEL - WITHOUT BOTTOM RAIL

Height	Length	White
36"	6'	207104A \$502.00
36"	8'	207105A \$669.33
42"	6'	207154A \$557.30
42"	8'	207155A \$769.73

Anodized Horizontal Baluster Kits - STAIR - WITHOUT BOTTOM RAIL

Height	Length	White
36"	6'	207106A \$621.35
36"	8'	207107A \$805.04
42"	6'	207156A \$727.43
42"	8'	207157A \$938.67

CUSTOM PROJECT?

Horizontal Baluster Infill Kits are available for aluminum, vinyl, composite and wood railing. See page 146 for details.



KIT INCLUDES:

- Top Rail w/ Aluminum Insert
- Top Sub-Rail
- Intermediate Baluster
- 5/8" Round Aluminum Balusters w/ Brackets
- Mounting Brackets w/Screws
- Rail Support

Post, Caps and Trim Sold Separately

PLEASE NOTE: Horizontal Baluster Stair Adapters are available for level angle installations. See page 23 for details.

Anodized Horizontal Baluster Kits - LEVEL - WITHOUT BOTTOM RAIL

Height	Length	White
36"	6'	207104B \$502.00
36"	8'	207105B \$669.33
42"	6'	207154B \$557.30
42"	8'	207155B \$769.73

Anodized Horizontal Baluster Kits - STAIR - WITHOUT BOTTOM RAIL

Height	Length	White
36"	6'	207106B \$621.35
36"	8'	207107B \$805.04
42"	6'	207156B \$727.43
42"	8'	207157B \$938.67

CUSTOM PROJECT?

Horizontal Baluster Infill Kits are available for aluminum, vinyl, composite and wood railing. See page 146 for details.

P310 Cellular PVC Railing Kits



KIT INCLUDES:

- Top Rail w/ Aluminum Insert
- Top Sub-Rail
- Bottom Rail w/ Aluminum Insert
- Side Stiles
- Stile Connectors
- Mounting Brackets w/Screws
- Mesh Infill Panel
- Rail Support

Post, Caps and Trim Sold Separately

Mill Mesh Infill Kits - LEVEL

Height	Length	White
36"	6'	209300 \$368.00
36"	8'	209301 \$490.67
42"	6'	209302 \$404.80
42"	8'	209303 \$539.73

HORIZONTAL BALUSTER STAIR KITS ARE A RECOMMENDED COORDINATE FOR STAIR APPLICATIONS. SEE PAGES 7 & 8.

CUSTOM PROJECT?
Mesh Panel Infill Kits are available for aluminum, vinyl, composite and wood railing. See page 146 for details.



KIT INCLUDES:

- Top Rail w/ Aluminum Insert
- Top Sub-Rail
- Bottom Rail w/ Aluminum Insert
- Side Stiles
- Stile Connectors
- Mounting Brackets w/Screws
- Mesh Infill Panel
- Rail Support

Post, Caps and Trim Sold Separately

Black Mesh Infill Kits - LEVEL

Height	Length	White
36"	6'	209304 \$368.00
36"	8'	209305 \$490.67
42"	6'	209306 \$404.80
42"	8'	209307 \$539.73

HORIZONTAL BALUSTER STAIR KITS ARE A RECOMMENDED COORDINATE FOR STAIR APPLICATIONS. SEE PAGES 7 & 8.

CUSTOM PROJECT?
Mesh Panel Infill Kits are available for aluminum, vinyl, composite and wood railing. See page 146 for details.



P315 SERIES

**CELLULAR PVC RAILING
FOR DECK BOARD* CAP RAIL**

RAILING COLOR

White**



FEATURES & BENEFITS

- 100% Extruded Cellular PVC Reinforced With Aluminum In Both Top & Bottom Rails
- Classic, Refined Profile - Won't Compromise Your View
- Dimensionally Stable - Won't Twist, Rot Or Splinter
- Hidden Mounting Brackets
- Level Top & Bottom Rails Are Machined For Square CPVC Balusters
- Soft Matte Finish Minimizes Glare & Surface Blemishes
- Impenetrable To Moisture - Mold & Mildew Resistant
- Two-Piece Top Rail - Ideal For In-Rail LED Lighting
- Coordinate Your Design By Installing Your Preferred Deck Board As A Cap Rail
- Customize It With Paint - Readily Accepts & Holds Any Paint Color With An LRV Greater Than 55**

INFILL OPTIONS

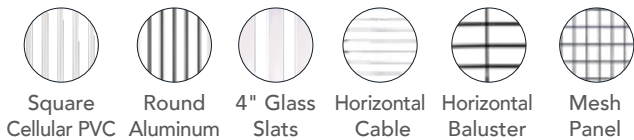

Square Cellular PVC Round Aluminum 4" Glass Slats Horizontal Cable Horizontal Baluster Mesh Panel

RAILING HEIGHTS

36" Residential • 42" Commercial
Meets IRC, IBC Standards

RAILING LENGTHS*

6', 8', 10' Level • 6', 8' Stair
Aluminum Reinforced Top & Bottom Rail

KITS INCLUDE

Top Rail, Sub-Rail & Bottom Rails, Balusters/Infill, Mounting Brackets & Hardware

For P315 Deck Board Installation The Sub-rail Is On Top. Deck Board Not Included In Kits

Limited Lifetime Warranty

* Available Lengths Depend On Choice Of Infill.

** Product may be painted. If you choose to paint the P300 Series cellular PVC railing, we recommend you use a premium grade acrylic paint with solar reflective pigment and one specifically for use with PVC products. Due to the expansion and contraction characteristics of PVC, P300 Series products should only be painted colors with an LRV (Light Reflective Value) greater than 55. The use of darker colors may cause damage due to excessive expansion or contraction and will void the product warranty.

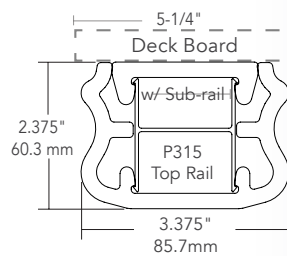

Top Rail
w/ Sub-rail

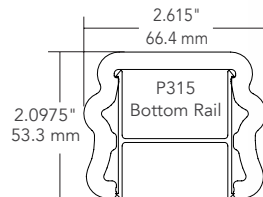

Bottom
Rail

**SQUARE CPVC BALUSTERS:
STAIR TOP RAIL IS PRE-ROUTED WHILE
THE BOTTOM RAIL REQUIRES SCREWS**

P315 Cellular PVC Railing Kits for Deck Board* Cap Rail



KIT INCLUDES*:

- Top Rail w/ Aluminum Insert
- Top Sub-Rail
- Bottom Rail w/ Aluminum Insert
- Square CPVC Balusters
- Rail Support
- Mounting Brackets w/Screws

Post, Caps and Trim Sold Separately

*Deck Board Not Included

RECOMMENDED POST LENGTH PURCHASE

36" w/Square Balusters = 39"
 42" w/Square Balusters = 48"

Bottom of stair posts will require additional post length to cover riser - typical 7" - 8"

PLEASE NOTE: When mixing square baluster kits with optional glass or aluminum balusters overall finish rail height will vary requiring the purchase of 42" square baluster kits.

Square Cellular Baluster Kits* - LEVEL

Height	Length	White
36"	6'	500525 \$214.90
36"	8'	500535 \$286.55
36"	10'	500545 \$358.19
42"	6'	500575 \$247.14
42"	8'	500585 \$329.53
42"	10'	500595 \$411.90

Square Cellular Baluster Kits* - STAIR 29°- 41°

Height	Length	White
36"	6'	500530 \$214.90
36"	8'	500540 \$286.55
42"	6'	500580 \$247.14
42"	8'	500590 \$329.53



KIT INCLUDES*:

- Top Rail w/ Aluminum Insert
- Top Sub-Rail
- Bottom Rail w/ Aluminum Insert
- 4" Tempered Glass Slats
- Glass Baluster Shoes
- Rail Support
- Mounting Brackets w/Screws

Post, Caps and Trim Sold Separately

*Deck Board Not Included

RECOMMENDED POST LENGTH PURCHASE

36" w/Glass Balusters = 48"
 42" w/Glass Balusters = 48"

Bottom of stair posts will require additional post length to cover riser - typical 7" - 8"

PLEASE NOTE: When mixing square baluster kits with optional glass or aluminum balusters overall finish rail height will vary requiring the purchase of 42" square baluster kits.

4" Glass Slat Kits* - LEVEL

Height	Length	White
36"	6'	500725 \$443.58
36"	8'	500735 \$591.45
42"	6'	500775 \$510.13
42"	8'	500785 \$680.17

4" Glass Slat Kits* - STAIR 30°- 34°

Height	Length	White
36"	6'	500730 \$443.58
36"	8'	500740 \$591.45
42"	6'	500780 \$510.13
42"	8'	500790 \$680.17

PLEASE NOTE: For P315 deckboard installation the sub-rail is on top.

P315 Cellular PVC Railing Kits for Deck Board* Cap Rail



KIT INCLUDES*:

- Top Rail w/ Aluminum Insert
- Top Sub-Rail
- Bottom Rail w/ Aluminum Insert
- Round Aluminum Balusters
- 3/4" Round Baluster Connectors
- Rail Support
- Mounting Brackets w/Screws

Post, Caps and Trim Sold Separately

*Deck Board Not Included

RECOMMENDED POST LENGTH PURCHASE

- 36" w/Aluminum Balusters = 48"
- 42" w/Aluminum Balusters = 48"

Bottom of stair posts will require additional post length to cover riser - typical 7" - 8"

PLEASE NOTE: When mixing square baluster kits with optional glass or aluminum balusters overall finish rail height will vary requiring the purchase of 42" square baluster kits.

Round Aluminum Baluster Kits* - LEVEL

Height	Length	White
36"	6'	500625(B) \$255.19
36"	8'	500635(B) \$340.26
36"	10'	500645(B) \$425.32
42"	6'	500675(B) \$290.69
42"	8'	500685(B) \$387.58

Round Aluminum Baluster Kits* - STAIR 30°- 37°

Height	Length	White
36"	6'	500630(B) \$252.76
36"	8'	500640(B) \$337.02
42"	6'	500680(B) \$290.69
42"	8'	500690(B) \$387.58

Round Aluminum Baluster Kits ship with black balusters. To receive balusters in the color of your choice, replace (B) in item number with the color letter shown.

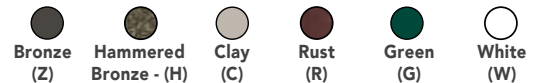

KIT INCLUDES*:

- Top Rail w/ Aluminum Insert
- Top Sub-Rail
- Bottom Rail w/ Aluminum Insert
- Rail Support
- Mounting Brackets w/Screws

Post, Caps Trim and Horizontal Cable Infill Sold Separately

*Deck Board Not Included

Cable Infill Rail Kits* - LEVEL

Height	Length	White
36" & 42"	6'	202025 \$144.24
36" & 42"	8'	202035 \$213.13

Cable Infill Rail Kits* - STAIR

Height	Length	White
36" & 42"	6'	202030 \$144.24
36" & 42"	8'	202040 \$213.13

SEE PAGES 143 & 144 FOR ALL HORIZONTAL CABLE COMPONENTS AND ACCESSORIES NOT INCLUDED IN KIT.

PLEASE NOTE: For P315 deckboard installation the sub-rail is on top.

P315 Cellular PVC Railing Kits for Deck Board* Cap Rail



KIT INCLUDES:

- Top Rail w/ Aluminum Insert
- Top Sub-Rail
- Bottom Rail w/ Aluminum Insert
- Intermediate Baluster
- 5/8" Round Aluminum Balusters w/ Brackets
- Mounting Brackets w/Screws
- Rail Support

Post, Caps and Trim Sold Separately

*Deck Board Not Included

PLEASE NOTE: Horizontal Baluster Stair Adapters are available for level angle installations. See page 23 for details.

Anodized Horizontal Baluster Kits* - LEVEL - WITH BOTTOM RAIL

Height	Length	White
36"	6'	207110A \$502.00
36"	8'	207111A \$669.33
42"	6'	207160A \$557.30
42"	8'	207161A \$769.73

Anodized Horizontal Baluster Kits* - STAIR - WITH BOTTOM RAIL

Height	Length	White
36"	6'	207112A \$621.35
36"	8'	207113A \$805.04
42"	6'	207162A \$727.43
42"	8'	207163A \$938.67

CUSTOM PROJECT?

Horizontal Baluster Infill Kits are available for aluminum, vinyl, composite and wood railing. See page 146 for details.



KIT INCLUDES:

- Top Rail w/ Aluminum Insert
- Top Sub-Rail
- Bottom Rail w/ Aluminum Insert
- Intermediate Baluster
- 5/8" Round Aluminum Balusters w/ Brackets
- Mounting Brackets w/Screws
- Rail Support

Post, Caps and Trim Sold Separately

*Deck Board Not Included

PLEASE NOTE: Horizontal Baluster Stair Adapters are available for level angle installations. See page 23 for details.

Black Horizontal Baluster Kits* - LEVEL - WITH BOTTOM RAIL

Height	Length	White
36"	6'	207110B \$502.00
36"	8'	207111B \$669.33
42"	6'	207160B \$557.30
42"	8'	207161B \$769.73

Black Horizontal Baluster Kits* - STAIR - WITH BOTTOM RAIL

Height	Length	White
36"	6'	207112B \$621.35
36"	8'	207113B \$805.04
42"	6'	207162B \$727.43
42"	8'	207163B \$938.67

CUSTOM PROJECT?

Horizontal Baluster Infill Kits are available for aluminum, vinyl, composite and wood railing. See page 146 for details.

PLEASE NOTE: For P315 deckboard installation the sub-rail is on top.

P315 Cellular PVC Railing Kits for Deck Board* Cap Rail



KIT INCLUDES*:

- Top Rail w/ Aluminum Insert
- Top Sub-Rail
- Intermediate Baluster
- 5/8" Round Aluminum Balusters w/ Brackets
- Mounting Brackets w/Screws
- Rail Support

Post, Caps and Trim Sold Separately

*Deck Board Not Included

PLEASE NOTE: Horizontal Baluster Stair Adapters are available for level angle installations. See page 23 for details.

Anodized Horizontal Baluster Kits* - LEVEL - WITHOUT BOTTOM RAIL

Height	Length	White
36"	6'	207114A \$502.00
36"	8'	207115A \$669.33
42"	6'	207164A \$577.30
42"	8'	207165A \$769.73

Anodized Horizontal Baluster Kits* - STAIR - WITHOUT BOTTOM RAIL

Height	Length	White
36"	6'	207116A \$621.35
36"	8'	207117A \$805.04
42"	6'	207166A \$727.43
42"	8'	207167A \$938.67

CUSTOM PROJECT?

Horizontal Baluster Infill Kits are available for aluminum, vinyl, composite and wood railing. See page 146 for details.



KIT INCLUDES*:

- Top Rail w/ Aluminum Insert
- Top Sub-Rail
- Intermediate Baluster
- 5/8" Round Aluminum Balusters w/ Brackets
- Mounting Brackets w/Screws
- Rail Support

Post, Caps and Trim Sold Separately

*Deck Board Not Included

PLEASE NOTE: Horizontal Baluster Stair Adapters are available for level angle installations. See page 23 for details.

Black Horizontal Baluster Kits* - LEVEL - WITHOUT BOTTOM RAIL

Height	Length	White
36"	6'	207114B \$502.00
36"	8'	207115B \$669.33
42"	6'	207164B \$577.30
42"	8'	207165B \$769.73

Black Horizontal Baluster Kits* - STAIR - WITHOUT BOTTOM RAIL

Height	Length	White
36"	6'	207116B \$621.35
36"	8'	207117B \$805.04
42"	6'	207166B \$727.43
42"	8'	207167B \$938.67

CUSTOM PROJECT?

Horizontal Baluster Infill Kits are available for aluminum, vinyl, composite and wood railing. See page 146 for details.

PLEASE NOTE: For P315 deckboard installation the sub-rail is on top.

P315 Cellular PVC Railing Kits for Deck Board* Cap Rail



Mill Mesh Infill Kits* - LEVEL

Height	Length	White
36"	6'	209310 \$368.00
36"	8'	209311 \$490.67
42"	6'	209312 \$404.80
42"	8'	209313 \$539.73

KIT INCLUDES*:

- Top Rail w/ Aluminum Insert
- Top Sub-Rail
- Bottom Rail w/ Aluminum Insert
- Side Stile
- Stile Connectors
- Mounting Brackets w/Screws
- Mesh Infill Panel
- Rail Support

Post, Caps and Trim Sold Separately

*Deck Board Not Included

HORIZONTAL BALUSTER STAIR KITS ARE A RECOMMENDED COORDINATE FOR STAIR APPLICATIONS. SEE PAGES 13 & 14.

CUSTOM PROJECT?

Mesh Panel Infill Kits are available for aluminum, vinyl, composite and wood railing. See page 146 for details.



Black Mesh Infill Kits* - LEVEL

Height	Length	White
36"	6'	209314 \$368.00
36"	8'	209315 \$490.67
42"	6'	209316 \$404.80
42"	8'	209317 \$539.73

KIT INCLUDES*:

- Top Rail w/ Aluminum Insert
- Top Sub-Rail
- Bottom Rail w/ Aluminum Insert
- Side Stiles
- Stile Connectors
- Mounting Brackets w/Screws
- Mesh Infill Panel
- Rail Support

Post, Caps and Trim Sold Separately

*Deck Board Not Included

HORIZONTAL BALUSTER STAIR KITS ARE A RECOMMENDED COORDINATE FOR STAIR APPLICATIONS. SEE PAGES 13 & 14.

CUSTOM PROJECT?

Mesh Panel Infill Kits are available for aluminum, vinyl, composite and wood railing. See page 146 for details.

PLEASE NOTE: For P315 deckboard installation the sub-rail is on top.

P300 SERIES

CELLULAR PVC RAILING
RAILING ACCESSORIES

17

CELLULAR PVC GATES & ACCESSORIES

18

CELLULAR PVC POST SLEEVES & ACCESSORIES

19

STRUCTURAL POST MOUNTS

20

CELLULAR PVC REPLACEMENT COMPONENTS



P310 White Cellular PVC Railing with Round Aluminum Balusters

P300 Cellular PVC Railing Gates & Accessories



Square



Horizontal Baluster

Mesh

GATE TIP: Add 1-1/2" to the published gate width for a perfect fit. Custom gates available.

Cellular PVC Square Railing Gates

Item Description	White
34"w x 36"h Railing Gate Fully Assembled & Includes: 2 - adjustable self-closing hinges & screws 1 - lockable latch	505100 \$548.22

Cellular PVC Horizontal Baluster Railing Gates

Item Description	Anodized	Textured Black
34-1/2"w x 36"h Railing Gate Fully Assembled & Includes: 2 - adjustable self-closing hinges & screws 1 - lockable latch	505000 \$608.84	505005 \$608.84
34-1/2"w x 42"h Railing Gate Fully Assembled and Includes: 2 - adjustable self-closing hinges & screws 1 - lockable latch	505010 \$710.32	505015 \$710.32

Cellular PVC Mesh Railing Gates

Item Description	Mill	Textured Black
34-1/2"w x 36"h Railing Gate Fully Assembled & Includes: 2 - adjustable self-closing hinges & screws 1 - lockable latch	505020 \$608.84	505025 \$608.84
34-1/2"w x 42"h Railing Gate Fully Assembled and Includes: 2 - adjustable self-closing hinges & screws 1 - lockable latch	505030 \$710.32	505035 \$710.32

Gate Accessories

Item Description	Black
A - Magna Latch Top Pull Safety Gate Latch	905100 \$138.16
B - External Access Kit Lockable push button operates latch from outside the fence.	905103 \$46.73
C - General Purpose Gate Latch Left or Right Hinge	905102 \$61.93
D - Gate Handle	905104 \$12.86
E - Gate Hinge (pair) 4" Includes 2 - heavy duty / self closing gate hinges and snap-on trim	905105P \$59.43
F - Gate Drop Rod	901040 \$128.00
G - Screw Packs for Gates	401094 \$7.45

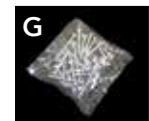

P300 Cellular PVC Post Sleeves & Accessories

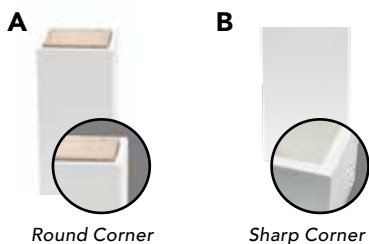

Round Corner

Sharp Corner



Sharp Corner
(Railing sold separately)

Bottom of stair posts will require additional post length to cover riser - Typical 7" - 8"

NOTE:: Recommended Post Length
36" P300 w/Aluminum Baluster = 48"
36" P300 w/Glass Baluster = 48"
42" P300 w/Aluminum Baluster = 48"
42" P300 w/Glass Baluster = 48"



*When the angle cut of the rail exceeds 22° you will need to use a 6.75" post sleeve.



K

Cellular PVC Post Sleeves* (Outside Corners Are Rounded)

Item Description	White
A - 4.25" x 4.25" x 39" Post Sleeve	500800 \$53.66
A - 4.25" x 4.25" x 48" Post Sleeve	500805 \$66.03
A - 4.25" x 4.25" x 108" Post Sleeve	500810 \$148.05

Cellular PVC Pre-Glued Post Wraps (Outside Corners Are Sharp)

B - 4.75" x 4.75" x 39" Pre-Glued Post Wrap	500055 \$116.90
B - 4.75" x 4.75" x 48" Pre-Glued Post Wrap	500056 \$144.00
B - 4.75" x 4.75" x 108" Pre-Glued Post Wrap	500057 \$324.00
C - 6.75" x 6.75" x 39" Pre-Glued Post Wrap	500050 \$162.02
C - 6.75" x 6.75" x 48" Pre-Glued Post Wrap	500051 \$199.20
C - 6.75" x 6.75" x 108" Pre-Glued Post Wrap	500052 \$448.20

Cellular PVC Brackets - For Use with P310 & P315

D - P300 Cellular Railing Bracket Pack - Level 4 Brackets, 1 Rail Support, Hardware	500090 \$33.20
E - P300 Cellular Railing Bracket Pack - Stair 4 Brackets, 1 Rail Support, Hardware	500091 \$33.20
F - P300 Cellular Railing Bracket Pack - Angle* 4 Brackets and Hardware	500092 \$33.20

Cellular PVC Railing Accessories - Caps & Trim

G - 4.25" x 4.25" Classic Post Cap	500070 \$11.49
H - 4.25" x 4.25" Classic Post Trim	500071 \$9.65
I - 4.75" x 4.75" Classic Post Cap	500082 \$47.78
J - 4.75" x 4.75" Classic Post Trim	500083 \$19.59
I - 6.75" x 6.75" Classic Post Cap	500080 \$65.89
J - 6.75" x 6.75" Classic Post Trim	500081 \$22.89

Cellular PVC Single Baluster

K - P310 CPVC 1 - 1/4" x 1 - 1/4" x 32" Baluster (36" Rail Kit) - Single	500030 \$13.12
K - P310 CPVC 1 - 1/4" x 1 - 1/4" x 38" Baluster (42" Rail Kit) - Single	500031 \$16.40

***PRE-DRILLED POST SLEEVES FOR HORIZONTAL CABLE FOUND ON PAGE 136**

P300 Cellular PVC Structural Post Mounts



Structural Post Mounts

Description	ITEM
A - 4" x 4" HEAVY-DUTY Structural Post Mount* <ul style="list-style-type: none"> 1.60" square steel post double welded for maximum strength. Includes leveling flange for all surfaces, four (4) 5/16" x 1" leveling Screws and leveling shims for non-level surface mounting. Residential/Commercial Top block can be flipped for 42" railing applications. 	401021A \$134.72
B - 4" x 4" STANDARD Structural Post Mount* <ul style="list-style-type: none"> 1.60" square steel post includes leveling shims for non-level surface mounting. Top block can be flipped for 42" railing applications 	401021 \$90.21
C - 23.5" Structural Post Block (For 36" Railing)	401054 \$34.40
C - 28.5" Structural Post Block (For 42" Railing)	401055 \$41.72

Structural Post Mounts Accessories

Description	ITEM
D - HEAVY-DUTY Structural Post Mount - Deck Mount Kit** <ul style="list-style-type: none"> Kit Includes: One (1) 4-hole top mounting plate, one (1) 8-hole bottom mounting plate, four (4) 3/8" x 6" mounting bolts, eight (8) 3/8" washers, eight (8) 3/8" nuts and four (4) 5/16" x 1" leveling screws Requires the use of a post trim ring to cover top mounting plate. 	401053 \$30.32
E - Joist Bracket for Structural Post Mounts	401002A \$57.00

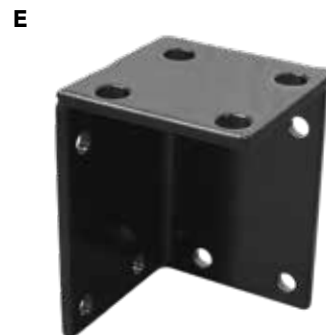
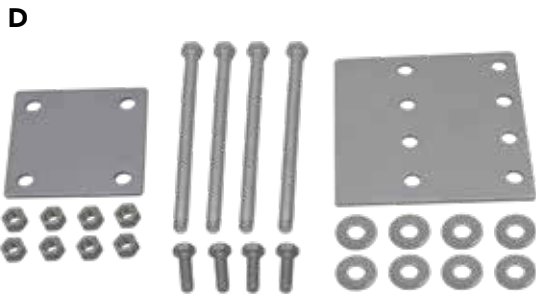

* (A) 4" x 4" HEAVY-DUTY Structural Post Mount and (B) 4" x 4" structural post mounts are coated with a heavy duty, two-layer protective textured finish designed and tested to resist corrosion in exterior applications.

** All components of the FAIRWAY® Structural Post Mount - Deck Mount Kit are coated with a three layer (metallic zinc layer, high-grade anti-corrosion chemical conversion film and baked ceramic surface coating), heavy-duty, high-grade metal surface processing technology that resists corrosion in exterior applications.

P300 Cellular PVC Replacement Components



P300 Cellular PVC Top Rail



P300 Cellular PVC Top Sub-Rail



P300 Cellular PVC Bottom Rail



Aluminum Insert

Replacement Cellular PVC Rails

Item Description	White
6' Cellular PVC Top Rail	500000 \$66.41
6' Cellular PVC Top Sub-Rail - Aluminum Baluster - Level	500905 \$34.53
6' Cellular PVC Top Sub-Rail - Aluminum Baluster - Stair	500915 \$34.53
6' Cellular PVC Bottom Rail - Aluminum Baluster - Level	500910 \$52.19
6' Cellular PVC Bottom Rail - Aluminum Baluster - Stair	500920 \$52.19
6' Cellular PVC Top Sub-Rail - Glass Slat - Level	500980 \$34.53
6' Cellular PVC Top Sub-Rail - Glass Slat - Stair	500990 \$34.53
6' Cellular PVC Bottom Rail - Glass Slat - Level	500985 \$52.19
6' Cellular PVC Bottom Rail - Glass Slat - Stair	500995 \$52.19
6' Cellular PVC Top Sub-Rail - Square Baluster - Level	500830 \$34.53
6' Cellular PVC Top Sub-Rail - Square Baluster - Stair	500840 \$34.53
6' Cellular PVC Bottom Rail - Square Baluster - Level	500835 \$52.19
6' Cellular PVC Bottom Rail - Square Baluster - Stair	500845 \$52.19



P310 White Cellular PVC Railing with Round Aluminum Balusters

P300 Cellular PVC Replacement Components



P300 Cellular PVC Top Rail



P300 Cellular PVC Top Sub-Rail



P300 Cellular PVC Bottom Rail



Aluminum Insert

Replacement Cellular PVC Rails

Item Description	White
8' Cellular PVC Top Rail	500010 \$88.55
8' Cellular PVC Top Sub-Rail - Aluminum Baluster - Level	500935 \$46.05
8' Cellular PVC Top Sub-Rail - Aluminum Baluster - Stair	500945 \$46.05
8' Cellular PVC Bottom Rail - Aluminum Baluster - Level	500940 \$69.60
8' Cellular PVC Bottom Rail - Aluminum Baluster - Stair	500950 \$69.60
8' Cellular PVC Top Sub-Rail - Glass Slat - Level	501010 \$46.05
8' Cellular PVC Top Sub-Rail - Glass Slat - Stair	501020 \$46.05
8' Cellular PVC Bottom Rail - Glass Slat - Level	501015 \$69.60
8' Cellular PVC Bottom Rail - Glass Slat - Stair	501025 \$69.60
8' Cellular PVC Top Sub-Rail - Square Baluster - Level	500860 \$46.05
8' Cellular PVC Top Sub-Rail - Square Baluster - Stair	500870 \$46.05
8' Cellular PVC Bottom Rail - Square Baluster - Level	500865 \$69.60
8' Cellular PVC Bottom Rail - Square Baluster - Stair	500875 \$69.60
10' Cellular PVC Top Rail	500020 \$110.68
10' Cellular PVC Top Sub-Rail - Aluminum Baluster - Level	500965 \$57.56
10' Cellular PVC Top Bottom Rail - Aluminum Baluster-Level	500970 \$87.00
10' Cellular PVC Sub-Rail - Square Baluster - Level	500890 \$57.56
10' Cellular PVC Bottom Rail - Square Baluster - Level	500895 \$87.00

Replacement Aluminum Inserts

Description	Item
6' Aluminum Insert	500060 \$48.24
8' Aluminum Insert	500061 \$64.32
10' Aluminum Insert	500062 \$80.39

P300 Cellular PVC Replacement Components

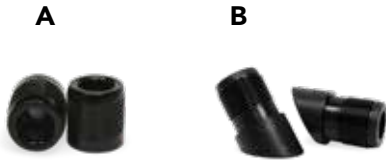

Clear Tempered Glass Slats

***PRICE SHOWN IS FOR ONE (1) GLASS SLAT, HOWEVER SLATS ARE ONLY SOLD IN PACKS OF FIVE (5). "EACH" PRICE X 5 = YOUR COST.**



Round Aluminum Balusters

Baluster Colors



Replacement Baluster Connectors & Shoes

Item Description	White	Black
A - Round Aluminum Baluster Connector Level (20/pk.)	N/A	301374 \$9.35
B - Round Aluminum Baluster Connector Stair (20/pk.)	N/A	301380 \$12.13
C - Glass Baluster Connector Shoe Level (2/pk.)	301381W \$13.80	301381 \$13.80
D - Glass Baluster Connector Shoe Stair (2/pk.)	301387W \$15.19	301387 \$15.19

Replacement Rail Supports

Item Description	White
5" Cellular Rail Support - Level	500033 \$9.05
7" Cellular Rail Support - Stair	500034 \$9.05

Replacement Glass Slats*

Item Description	Clear
4" x 5/16" x 32" Clear Tempered Glass Slats - Level	301372 \$15.86 /ea.
4" x 5/16" x 38" Clear Tempered Glass Slats - Level	301373 \$18.59 /ea.
4" x 5/16" x 32-1/4" Clear Tempered Glass Slats - Stair	301384 \$17.22 /ea.
4" x 5/16" x 40" Clear Tempered Glass Slats - Stair	301386 \$19.74 /ea.

Replacement Round Aluminum Balusters

Item Description	Black (B)	Bronze (Z)	Hammered Bronze (H)	Clay (C)	Rust (R)	Green (G)	White (W)
32" Round Aluminum Baluster (1pc.)	301416 \$3.40	301418 \$3.52	301427 \$3.52	301420 \$3.52	301424 \$3.52	301422 \$3.52	301426 \$3.52
36" Round Aluminum Baluster (1pc.)	301440 \$3.88	301442 \$4.01	301443 \$4.01	301444 \$4.01	301448 \$4.01	301446 \$4.01	301450 \$4.01



P310 White Cellular Railing with Cellular PVC Square Balusters

P300 Cellular PVC Replacement Components

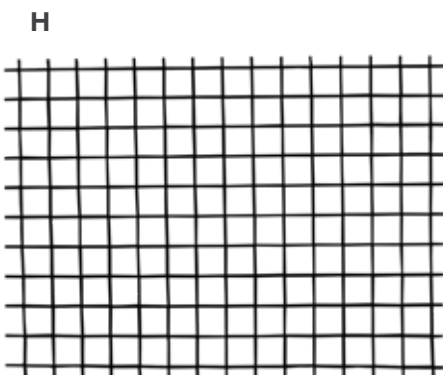
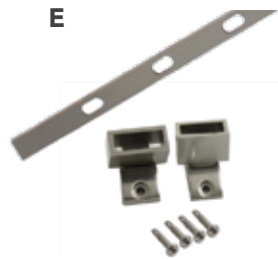
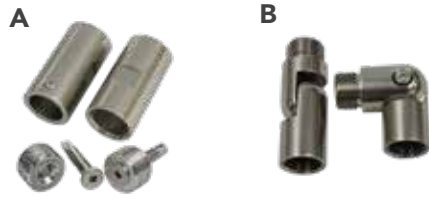

Horizontal Baluster Brackets & Horizontal Balusters

Item Description	Anodized	Textured Black
A - Horizontal Baluster Bracket & Hardware - Level	203005 \$22.66	203004 \$22.66
B - Horizontal Baluster Adapter & Hardware - Stair NOTE: Must be used in conjunction with (A), item 401021A	203007 \$44.06	203006 \$44.06
C - 6' Horizontal Baluster	203000 \$33.85	203002 \$33.85
C - 8' Horizontal Baluster	203001 \$45.67	203003 \$45.67
D - Horizontal Intermediate Baluster & Hardware - Level	203009 \$135.28	203008 \$135.28
E - Horizontal Intermediate Baluster & Hardware - Stair	203011 \$147.52	203010 \$147.52

Tool & Template

Item Description	Item
F - Horizontal Baluster Installation Tool	203013 \$5.60
G - Horizontal Baluster Drill Template	203012 \$36.42

Wire Mesh Infill Panels

Item Description	Mill	Black
H - 6' x 36" x 3" Wire Mesh Infill Panel	209008 \$259.99	209002 \$259.99
H - 8' x 36" x 3" Wire Mesh Infill Panel	209010 \$350.99	209004 \$350.99
H - 6' x 42" x 3" Wire Mesh Infill Panel	209009 \$311.99	209003 \$311.99
H - 8' x 42" x 3" Wire Mesh Infill Panel	209011 \$416.99	209005 \$416.99



P310 White Cellular Railing with Cellular PVC Square Balusters

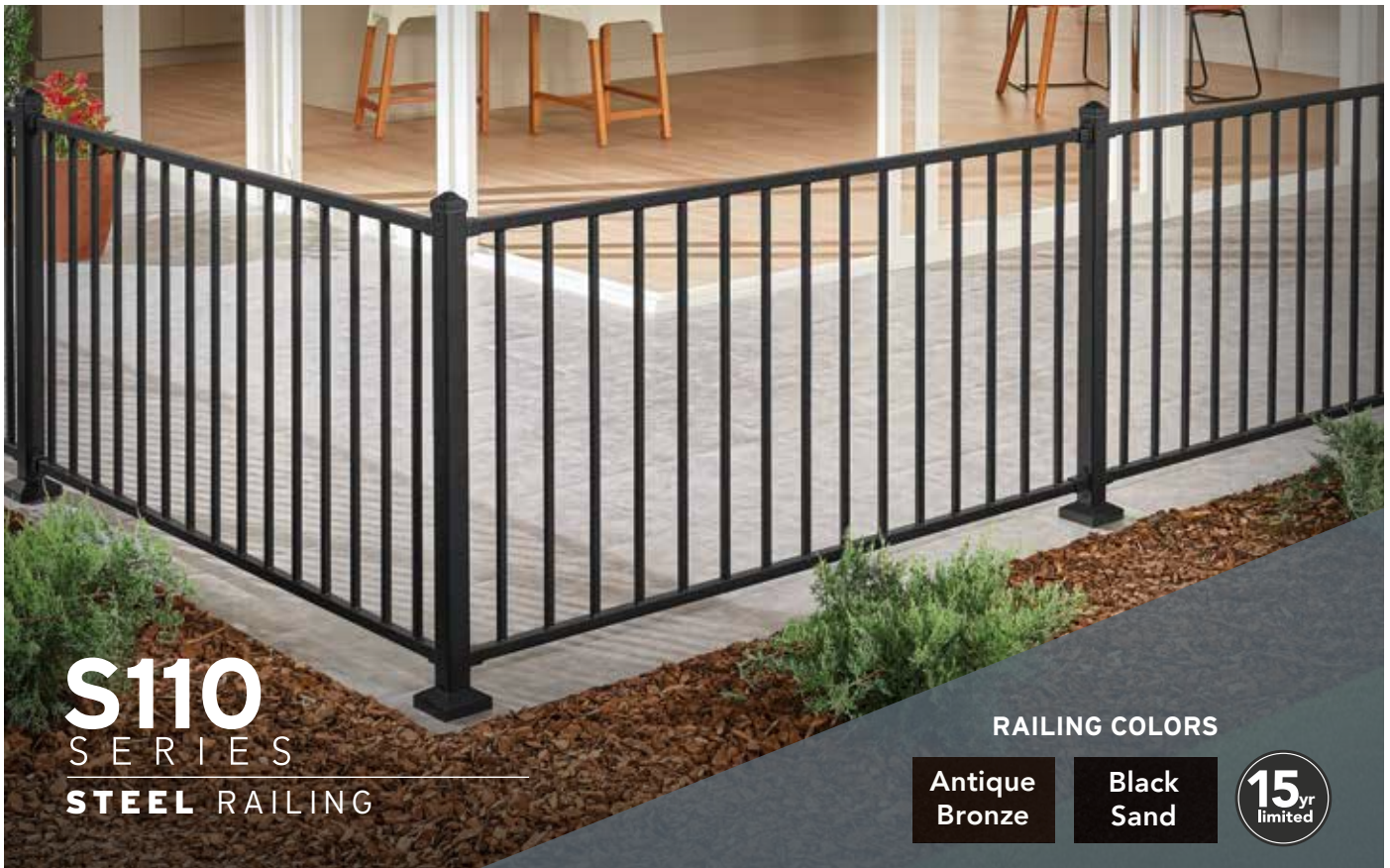

S110

SERIES

STEEL RAILING

RAILING COLORS

Antique
Bronze

Black
Sand

15^{yr}
limited

FEATURES & BENEFITS

- Pre-Welded Panels - Makes Installation Quick & Easy
- AAMA-2604 Powder Coated For Sustained Durability
- Minimal, Modern Profile - Won't Obstruct Your View
- Soft Matte Finish Minimizes Glare & Surface Blemishes
- Coordinate Your Design By Installing Your Preferred Deck Board As A Cap Rail
- Versatile Design Can Be Used As Infill Between Vinyl, Composite or Wood
- Brackets, Posts, Caps & Trim Kit Sold Separately

INFILL OPTIONS



Pre-Assembled Steel
Square Baluster Panel

RAILING HEIGHTS

36" • 42"

Meets IRC, IBC Standards

RAILING LENGTHS

70", 94" Level • 70", 94" Stair

FLANGED POST KITS INCLUDE

Flanged Post, Flat Cover & Trim

AAMA-2604 Compliant Powder Coating

15-Year Limited Warranty

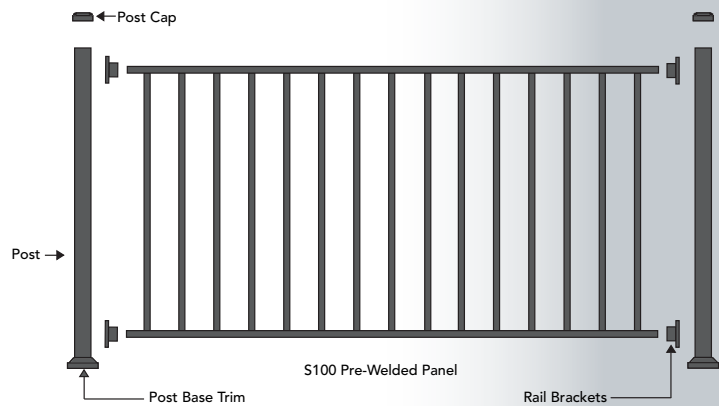

S110 Steel Railing Kits



KIT INCLUDES:

- Pre-Assembled Steel Panel

Post, Caps, Trim and Top & Bottom Brackets Sold Separately

CUSTOM PROJECT?

Steel Panel Infill Kits are available for vinyl, composite and wood railing. See page 147 for details.

Steel Panel Kits - LEVEL with Square Balusters

Height	Length	Antique Bronze	Black Sand
28"	70"	307030 \$117.99	307000 \$117.99
28"	94"	307090 \$147.55	307060 \$147.55
34"	70"	307035 \$128.21	307005 \$128.21
34"	94"	307095 \$158.72	307065 \$158.72
40"	70"	307040 \$144.57	307010 \$144.57
40"	94"	307100 \$177.03	307070 \$177.03

Steel Panel Kits - STAIR with Square Balusters

Height	Length	Angle	Antique Bronze	Black Sand
28"	70"	Up to 42°	307045 \$172.11	307015 \$172.11
28"	94"	Up to 42°	307105 \$194.61	307075 \$194.61
34"	70"	Up to 42°	307050 \$186.87	307020 \$186.87
34"	94"	Up to 42°	307110 \$211.83	307080 \$211.83
40"	70"	Up to 42°	307055 \$206.54	307025 \$206.54
40"	94"	Up to 42°	307115 \$229.94	307085 \$229.94



S110 Black Sand Pre-Assembled Panel with Steel Posts

S110 Steel Railing Components & Hardware

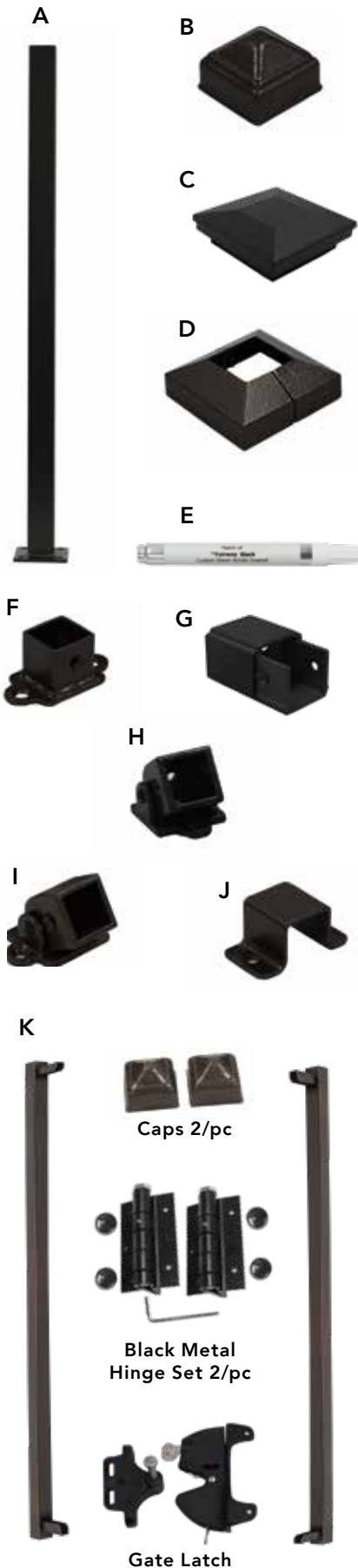

Post & Accessories

Item Description	Antique Bronze	Black Sand
A - 2" x 2" x 39" Flanged Post Kits (Includes Flat Cover & Trim)	307170 \$66.28	307140 \$66.28
A - 2" x 2" x 44" Flanged Post Kits (Includes Flat Cover & Trim)	307175 \$73.24	307145 \$73.24
A - 2" x 2" x 54" Flanged Post Kits (Includes Flat Cover & Trim)	307180 \$88.44	307150 \$88.44
A - 3" x 3" x 39" Flanged Post Kits (Includes Flat Cover & Trim)	307185 \$84.30	307155 \$84.30
A - 3" x 3" x 44" Flanged Post Kits (Includes Flat Cover & Trim)	307190 \$92.51	307160 \$92.51
A - 3" x 3" x 54" Flanged Post Kits (Includes Flat Cover & Trim)	307195 \$106.88	307165 \$106.88
B - 2" Dome Cap	307260 \$6.78	307240 \$6.78
B - 3" Dome Cap	307265 \$7.24	307245 \$7.24
C - 2" Pyramid Cap	307261 \$14.27	307241 \$14.27
C - 3" Pyramid Cap	307266 \$19.10	307246 \$19.10
D - 2" Post Base Trim 2/pc	307270 \$10.99	307250 \$10.99
D - 3" Post Base Trim 2/pc	307275 \$11.44	307255 \$11.44
E - Touch-Up Paint Pen Black TIP: A recommended alternative touch-up paint - Rust-oleum Textured Black: Mfr. Model #7220830 - Available at most hardware stores.	"Use Black Sand" →	307320 \$14.20

Hardware

Item Description	Antique Bronze	Black Sand
F - Rail Bracket - Level PTP (4/pk)	307220 \$44.25	307200 \$44.25
G - Cup & Cover Bracket - Level PTP (4/pk)	307221 \$44.25	307201 \$44.25
H - Rail Multi-Pitch Bracket - Stair (4/pk)	307225 \$52.12	307205 \$52.12
I - Rail Multi-Angle Bracket - Level PTP (4/pk)	307230 \$54.09	307210 \$54.09
J - Deck Board Cap Rail Brackets (4/pk)	307235 \$29.50	307215 \$29.50

Railing Gate

Item Description	Antique Bronze	Black Sand
K - Railing Gate Kit* - 34.5" w x 36" h (Included: 2 Self Closing Hinges w/ Hardware and Lockable Latch) *Pre-Assembled Panel Sold Separately	307310 \$227.01	307300 \$227.01
K - Railing Gate Kit* - 34.5" w x 42" h (Included: 2 Self Closing Hinges w/ Hardware and Lockable Latch) *Pre-Assembled Panel Sold Separately	307315 \$236.96	307305 \$236.96

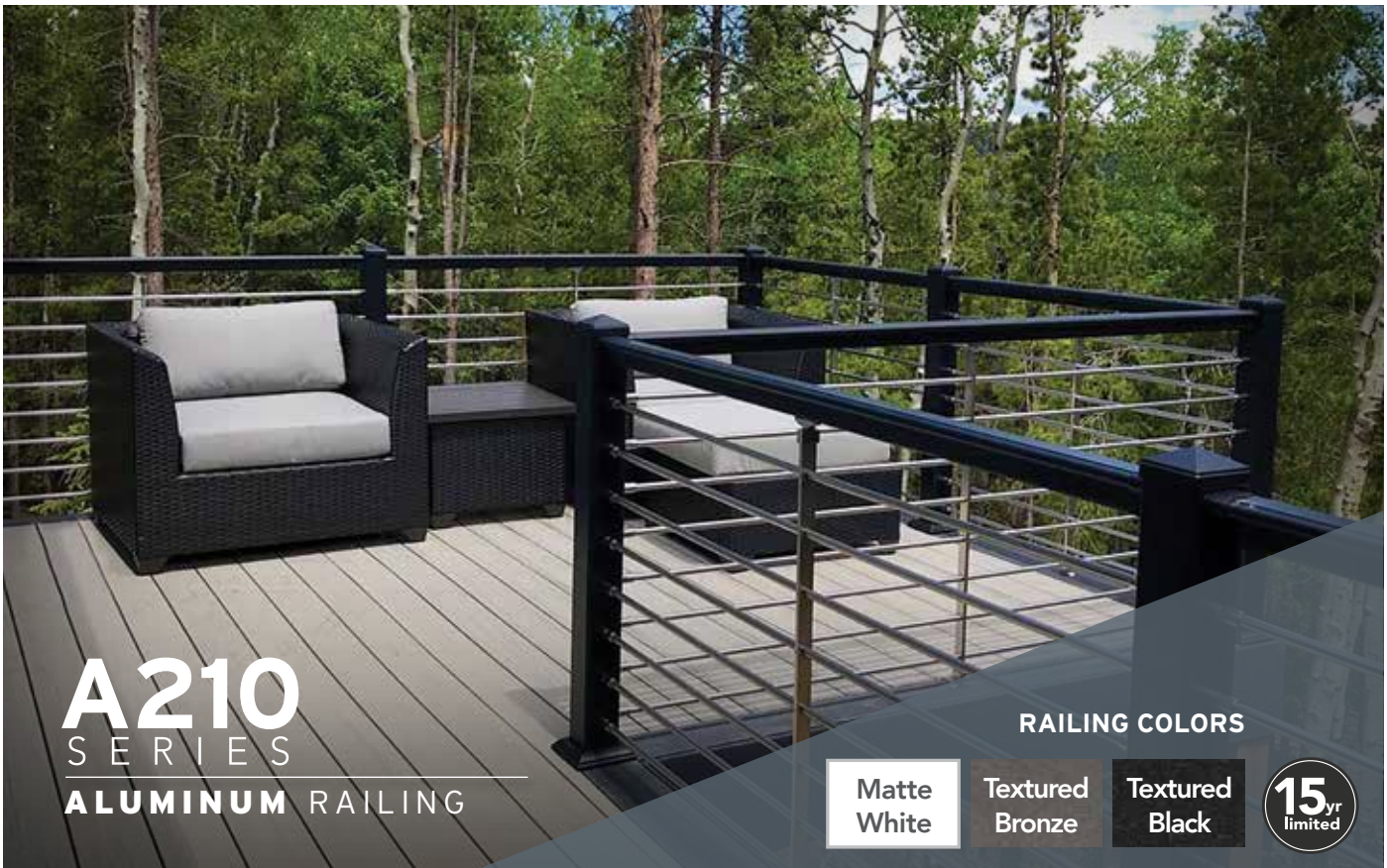

A210

SERIES
ALUMINUM RAILING

RAILING COLORS

- Matte White
- Textured Bronze
- Textured Black



FEATURES & BENEFITS

- Available in **Pre-Assembled Panels**
- Quick & Easy Bracket Installation With Template
- AAMA-2604 Powder Coated For Sustained Durability
- Sleek, Slim Profile - Won't Obstruct Your View
- Dual Post Application - Compatible With Post-To-Post Or Over-The-Post Applications
- Two-Piece Top Rail - Ideal For In-Rail LED Lighting
- Soft Matte Finish Minimizes Glare & Surface Blemishes
- ADA Secondary Handrail Available In Matching Colors

INFILL OPTIONS



RAILING HEIGHTS

36" Residential • 42" Commercial
Meets IRC, IBC, ASTM E935 & E985 Standards

RAILING LENGTHS

Standard*: 4', 6', 8' Level • 4', 6', 8' Stair
Pre-Assembled Panels: 3', 4', 5', 6', 7', 8' Level

KITS INCLUDE

Top Rail, Sub-Rail & Bottom Rails, Balusters/Infill, Mounting Brackets & Hardware

AAMA 2604 Compliant Powder Coating

15-Year Limited Warranty

** Available Lengths Depend On Choice Of Infill.*

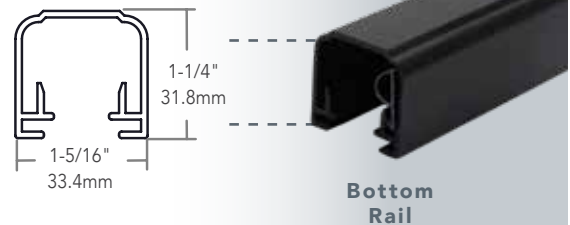
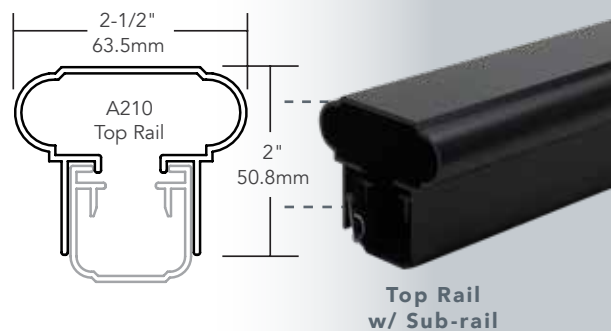

A210 Aluminum Railing Kits

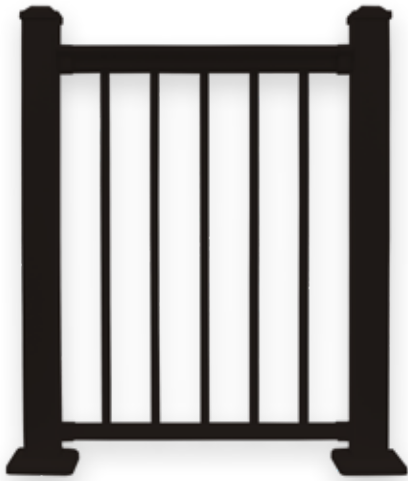

KIT INCLUDES:

- Top Rail
- Top Sub-Rail with Baluster Insert
- Bottom Rail with Baluster Insert
- Mounting Brackets w/Screws
- Square Aluminum Balusters
- Rail Support
- Installation Template (Level Only)

Posts, Caps and Trim Sold Separately

Square Aluminum Baluster Kits - LEVEL

Height	Length	Matte White	Textured Bronze	Textured Black
36"	4'	306017 \$136.00	306011 \$136.00	306001 \$136.00
36"	6'	306016 \$204.00	306010 \$204.00	306000 \$204.00
36"	8'	306018 \$272.00	306015 \$272.00	306005 \$272.00
42"	4'	306057 \$149.60	306049 \$149.60	306039 \$149.60
42"	6'	306056 \$224.40	306050 \$224.40	306040 \$224.40
42"	8'	306058 \$299.20	306055 \$299.20	306045 \$299.20

Square Aluminum Baluster Kits - STAIR 30°- 34°

Height	Length	Matte White	Textured Bronze	Textured Black
36"	4'	306037 \$136.00	306024 \$136.00	306019 \$136.00
36"	6'	306026 \$204.00	306025 \$204.00	306020 \$204.00
36"	8'	306036 \$272.00	306035 \$272.00	306030 \$272.00
42"	4'	306066 \$149.60	306064 \$149.60	306059 \$149.60
42"	6'	306067 \$224.40	306065 \$224.40	306060 \$224.40
42"	8'	306076 \$299.20	306075 \$299.20	306070 \$299.20



A210 Textured Bronze with Square Balusters

A210 Aluminum Railing Kits

NEW!

PRE-ASSEMBLED PANELS



KIT INCLUDES:

- Pre-Assembled Panel with Square Aluminum Balusters
- Top Rail
- Brackets & Hardware
- Bracket Covers
- Rail Support

Posts, Caps and Trim Sold Separately



A210 Textured Black with Square Balusters

Pre-Assembled Panels - Square Aluminum Balusters - LEVEL

Height	Length	Matte White	Textured Bronze	Textured Black
36"	3'	306812 \$117.90	306806 \$117.90	306800 \$117.90
36"	4'	306813 \$157.20	306807 \$157.20	306801 \$157.20
36"	5'	306814 \$196.50	306808 \$196.50	306802 \$196.50
36"	6'	306815 \$235.80	306809 \$235.80	306803 \$235.80
36"	7'	306816 \$275.10	306810 \$275.10	306804 \$275.10
36"	8'	306817 \$314.39	306811 \$314.39	306805 \$314.39
42"	3'	306830 \$135.62	306824 \$135.62	306818 \$135.62
42"	4'	306831 \$180.82	306825 \$180.82	306819 \$180.82
42"	5'	306832 \$226.03	306826 \$226.03	306820 \$226.03
42"	6'	306833 \$271.23	306827 \$271.23	306821 \$271.23
42"	7'	306834 \$316.44	306828 \$316.44	306822 \$316.44
42"	8'	306835 \$362.05	306829 \$362.05	306823 \$362.05



A210 Textured Black with Square Balusters



A210 Textured Black with Square Balusters

A210 Aluminum Railing Kits



NEW!

3-Rail Infill Kits - LEVEL

Height	Length	Matte White	Textured Bronze	Textured Black
42"	4'	306844 \$206.10	306842 \$206.10	306840 \$206.10
42"	6'	306866 \$288.10	306858 \$288.10	306850 \$288.10
42"	8'	306870 \$367.45	306862 \$367.45	306854 \$367.45

3-Rail Infill Kits - STAIR

Height	Length	Matte White	Textured Bronze	Textured Black
42"	4'	306874 \$206.10	306873 \$206.10	306872 \$206.10
42"	6'	306877 \$288.10	306876 \$288.10	306875 \$288.10
42"	8'	306880 \$367.45	306879 \$367.45	306878 \$367.45

KIT INCLUDES:

- Top Rail
- Top Sub-Rail with Baluster Insert
- Mid-Rail
- Bottom Rail with Baluster Insert
- Square Aluminum Balusters
- Mounting Brackets w/Screws
- Rail Support

Posts, Caps and Trim Sold Separately



A210 Textured Black 3-Rail

A210 Aluminum Railing Kits



KIT INCLUDES:

- Top Rail
- Top Sub-Rail with Baluster Insert
- Bottom Rail with Baluster Insert
- Glass Slat Shoes
- 4" Tempered Glass Slats
- Mounting Brackets w/Screws
- Rail Support

Posts, Caps and Trim Sold Separately

4" Glass Slat Kits - LEVEL

Height	Length	Matte White	Textured Bronze	Textured Black
36"	4'	306704 \$268.69	306702 \$268.69	306700 \$268.69
36"	6'	306710 \$403.04	306708 \$403.04	306706 \$403.04
36"	8'	306716 \$537.39	306714 \$537.39	306712 \$537.39
42"	4'	306740 \$295.56	306738 \$295.56	306736 \$295.56
42"	6'	306746 \$443.35	306744 \$443.35	306742 \$443.35
42"	8'	306752 \$591.13	306750 \$591.13	306748 \$591.13

4" Glass Slat Kits - STAIR 30°- 34°

Height	Length	Matte White	Textured Bronze	Textured Black
36"	4'	306722 \$321.25	306720 \$321.25	306718 \$321.25
36"	6'	306728 \$481.87	306726 \$481.87	306724 \$481.87
36"	8'	306734 \$642.50	306732 \$642.50	306730 \$642.50
42"	4'	306758 \$353.37	306756 \$353.37	306754 \$353.37
42"	6'	306764 \$530.06	306762 \$530.06	306760 \$530.06
42"	8'	306770 \$706.75	306768 \$706.75	306766 \$706.75



KIT INCLUDES:

- Top Rail
- Bottom Rail
- Top Sub-Rail
- Rail Support
- Mounting Brackets w/Screws
- Installation Template - Level Only

Post, Caps, Trim and Horizontal Cable Infill Sold Separately

Cable Infill Rail Kits - LEVEL

Height	Length	Matte White	Textured Bronze	Textured Black
36" & 42"	6'	201620 \$111.14	201621 \$111.14	201622 \$111.14
36" & 42"	8'	201623 \$136.83	201624 \$136.83	201625 \$136.83

Cable Infill Rail Kits - STAIR

Height	Length	Matte White	Textured Bronze	Textured Black
36" & 42"	6'	201626 \$121.70	201627 \$121.70	201628 \$121.70
36" & 42"	8'	201629 \$149.83	201630 \$149.83	201631 \$149.83

***FOR OTP APPLICATION, POST, CAPS, AND TRIM SOLD SEPARATELY.
THIS APPLICATION REQUIRES 1-7/8" POST SLEEVES (PRE-DRILLED IS SPECIAL ORDER).
SEE PAGES 143 & 144 FOR ALL HORIZONTAL CABLE COMPONENTS
AND ACCESSORIES NOT INCLUDED IN KIT.**

A210 Aluminum Railing Kits



KIT INCLUDES:

- Top Rail
- Top Sub-Rail
- Bottom Rail
- Intermediate Baluster
- 5/8" Round Aluminum Balusters w/ Brackets
- Mounting Brackets w/Screws
- Rail Support - Surface Mount

Posts, Caps and Trim Sold Separately

PLEASE NOTE: Horizontal Baluster Stair Adapters are available for level angle installations. See page 42 for details.

Anodized Horizontal Baluster Kits - LEVEL - WITH BOTTOM RAIL

Height	Length	Matte White	Textured Bronze	Textured Black
36"	6'	203100A \$502.00	203200A \$502.00	203300A \$502.00
36"	8'	203101A \$669.33	203201A \$669.33	203301A \$669.33
42"	6'	203150A \$577.30	203250A \$577.30	203350A \$557.30
42"	8'	203151A \$769.73	203251A \$769.73	203351A \$769.73

Anodized Horizontal Baluster Kits - STAIR - WITH BOTTOM RAIL

Height	Length	Matte White	Textured Bronze	Textured Black
36"	6'	203102A \$621.35	203202A \$621.35	203302A \$621.35
36"	8'	203103A \$805.04	203203A \$805.04	203303A \$805.04
42"	6'	203152A \$727.43	203252A \$727.43	203352A \$727.43
42"	8'	203153A \$938.67	203253A \$938.67	203353A \$938.67

CUSTOM PROJECT?

Horizontal Baluster Infill Kits are available for vinyl, composite and wood railing. See page 146 for details.



KIT INCLUDES:

- Top Rail
- Top Sub-Rail
- Bottom Rail
- Intermediate Baluster
- 5/8" Round Aluminum Balusters w/ Brackets
- Mounting Brackets w/Screws
- Rail Support - Surface Mount

Posts, Caps and Trim Sold Separately

PLEASE NOTE: Horizontal Baluster Stair Adapters are available for level angle installations. See page 23 for details.

Black Horizontal Baluster Kits - LEVEL - WITH BOTTOM RAIL

Height	Length	Matte White	Textured Bronze	Textured Black
36"	6'	203100B \$502.00	203200B \$502.00	203300B \$502.00
36"	8'	203101B \$669.33	203201B \$669.33	203301B \$669.33
42"	6'	203150B \$577.30	203250B \$577.30	203350B \$557.30
42"	8'	203151B \$769.73	203251B \$769.73	203351B \$769.73

Black Horizontal Baluster Kits - STAIR - WITH BOTTOM RAIL

Height	Length	Matte White	Textured Bronze	Textured Black
36"	6'	203102B \$621.35	203202B \$621.35	203302B \$621.35
36"	8'	203103B \$805.04	203203B \$805.04	203303B \$805.04
42"	6'	203152B \$727.43	203252B \$727.43	203352B \$727.43
42"	8'	203153B \$938.67	203253B \$938.67	203353B \$938.67

CUSTOM PROJECT?

Horizontal Baluster Infill Kits are available for vinyl, composite and wood railing. See page 146 for details.

A210 Aluminum Railing Kits



KIT INCLUDES:

- Top Rail
- Top Sub-Rail
- Intermediate Baluster
- 5/8" Round Aluminum Balusters w/ Brackets
- Mounting Brackets w/Screws
- Rail Support - Surface Mount

Posts, Caps and Trim Sold Separately

PLEASE NOTE: Horizontal Baluster Stair Adapters are available for level angle installations. See page 23 for details.

Anodized Horizontal Baluster Kits - LEVEL - WITHOUT BOTTOM RAIL

Height	Length	Matte White	Textured Bronze	Textured Black
36"	6'	203104A \$502.00	203204A \$502.00	203304A \$502.00
36"	8'	203105A \$669.33	203205A \$669.33	203305A \$669.33
42"	6'	203154A \$577.30	203254A \$577.30	203354A \$577.30
42"	8'	203155A \$769.73	203255A \$769.73	203355A \$769.73

Anodized Horizontal Baluster Kits - STAIR - WITHOUT BOTTOM RAIL

Height	Length	Matte White	Textured Bronze	Textured Black
36"	6'	203106A \$621.35	203206A \$621.35	203306A \$621.35
36"	8'	203107A \$805.04	203207A \$805.04	203307A \$805.04
42"	6'	203156A \$727.43	203256A \$727.43	203356A \$727.43
42"	8'	203157A \$938.67	203257A \$938.67	203357A \$938.67

CUSTOM PROJECT?

Horizontal Baluster Infill Kits are available for vinyl, composite and wood railing. See page 146 for details.



KIT INCLUDES:

- Top Rail
- Top Sub-Rail
- Intermediate Baluster
- 5/8" Round Aluminum Balusters w/ Brackets
- Mounting Brackets w/Screws
- Rail Support - Surface Mount

Posts, Caps and Trim Sold Separately

PLEASE NOTE: Horizontal Baluster Stair Adapters are available for level angle installations. See page 23 for details.

Black Horizontal Baluster Kits - LEVEL - WITHOUT BOTTOM RAIL

Height	Length	Matte White	Textured Bronze	Textured Black
36"	6'	203104B \$502.00	203204B \$502.00	203304B \$502.00
36"	8'	203105B \$669.33	203205B \$669.33	203305B \$669.33
42"	6'	203154B \$577.30	203254B \$577.30	203354B \$577.30
42"	8'	203155B \$769.73	203255B \$769.73	203355B \$769.73

Black Horizontal Baluster Kits - STAIR - WITHOUT BOTTOM RAIL

Height	Length	Matte White	Textured Bronze	Textured Black
36"	6'	203106B \$621.35	203206B \$621.35	203306B \$621.35
36"	8'	203107B \$805.04	203207B \$805.04	203307B \$805.04
42"	6'	203156B \$727.43	203256B \$727.43	203356B \$727.43
42"	8'	203157B \$938.67	203257B \$938.67	203357B \$938.67

CUSTOM PROJECT?

Horizontal Baluster Infill Kits are available for vinyl, composite and wood railing. See page 146 for details.

A210 Aluminum Railing Kits



KIT INCLUDES:

- Top Rail
- Top Sub-Rail
- Bottom Rail
- Square Aluminum Side Stiles
- Stile Connectors
- Mesh Infill Panel
- Mounting Brackets w/Screws
- Rail Support - Surface Mount

Posts, Caps and Trim Sold Separately

Mill Mesh Infill Kits - LEVEL

Height	Length	Matte White	Textured Bronze	Textured Black
36"	6'	209120 \$368.00	209110 \$368.00	209100 \$368.00
36"	8'	209121 \$490.67	209111 \$490.67	209101 \$490.67
42"	6'	209122 \$404.80	209112 \$404.80	209102 \$404.80
42"	8'	209123 \$539.73	209113 \$539.73	209103 \$539.73

HORIZONTAL BALUSTER STAIR KITS ARE A RECOMMENDED COORDINATE FOR STAIR APPLICATIONS. SEE PAGES 32 & 33.

CUSTOM PROJECT?

Mesh Panel Infill Kits are available for vinyl, composite and wood railing. See page 146 for details.



KIT INCLUDES:

- Top Rail
- Top Sub-Rail
- Bottom Rail
- Square Aluminum Side Stiles
- Stile Connectors
- Mesh Infill Panel
- Mounting Brackets w/Screws
- Rail Support - Surface Mount

Posts, Caps and Trim Sold Separately

Black Mesh Infill Kits - LEVEL

Height	Length	Matte White	Textured Bronze	Textured Black
36"	6'	209124 \$368.00	209114 \$368.00	209104 \$368.00
36"	8'	209125 \$490.67	209115 \$490.67	209105 \$490.67
42"	6'	209126 \$404.80	209116 \$404.80	209106 \$404.80
42"	8'	209127 \$539.73	209117 \$539.73	209107 \$539.73

HORIZONTAL BALUSTER STAIR KITS ARE A RECOMMENDED COORDINATE FOR STAIR APPLICATIONS. SEE PAGES 32 & 33.

CUSTOM PROJECT?

Mesh Panel Infill Kits are available for vinyl, composite and wood railing. See page 146 for details.



A210 SERIES

ALUMINUM RAILING
RAILING ACCESSORIES

- 36 ALUMINUM GATES & ACCESSORIES
- 37 ALUMINUM ACCESSORIES
- 38 STRUCTURAL POST MOUNTS
- 39 ALUMINUM COMPONENTS & HARDWARE
- 40 ALUMINUM REPLACEMENT COMPONENTS

PLEASE NOTE WHEN ORDERING OTP (OVER-THE-POST) BRACKETS YOU MUST USE A 1-7/8" POST.



*A210 Textured Bronze
with Horizontal Balusters*

A210 Aluminum Railing Gates & Accessories

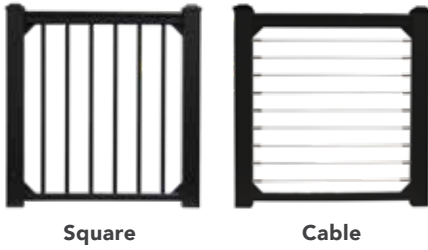

Square

Cable

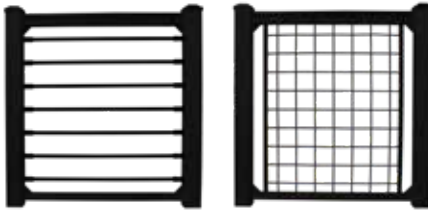

Horizontal Baluster

Mesh

All Gates Are Fully Assembled & Include:

- 2 - Adjustable self-closing hinges & screws
- 1 - Lockable latch

GATE TIP: Add 1-1/2" to the published gate width for a perfect fit. Custom gates available.

Aluminum Railing Gates with Square Balusters

Item Description	Matte White	Textured Bronze	Textured Black
34-1/2" w x 36" h Railing Gate	306083 \$608.84	306082 \$608.84	306080 \$608.84
34-1/2" w x 42" h Railing Gate	306088 \$710.32	306086 \$710.32	306084 \$710.32

Aluminum Railing Gates with Cable

Item Description	Matte White	Textured Bronze	Textured Black
34-1/2" w x 36" h Railing Gate	306892 \$708.85	306891 \$708.85	306890 \$708.85
34-1/2" w x 42" h Railing Gate	306895 \$810.35	306894 \$810.35	306893 \$810.35

Aluminum Railing Gates with Horizontal Balusters

Item Description	Matte White		Textured Bronze		Textured Black	
	Anodized	Tex. Black	Anodized	Tex. Black	Anodized	Tex. Black
34-1/2" w x 36" h Railing Gate	306917 \$608.85	306916 \$608.85	306914 \$608.85	306913 \$608.85	306912 \$608.85	306910 \$608.85
34-1/2" w x 42" h Railing Gate	306923 \$710.35	306922 \$710.35	306921 \$710.35	306920 \$710.35	306919 \$710.35	306918 \$710.35

Aluminum Railing Gates with Mesh

Item Description	Matte White		Textured Bronze		Textured Black	
	Mill	Tex. Black	Mill	Tex. Black	Mill	Tex. Black
34-1/2" w x 36" h Railing Gate	306929 \$608.85	306928 \$608.85	306927 \$608.85	306926 \$608.85	306925 \$608.85	306924 \$608.85
34-1/2" w x 42" h Railing Gate	306935 \$710.35	306934 \$710.35	306933 \$710.35	306932 \$710.35	306931 \$710.35	306930 \$710.35

Gate Accessories

Item Description	Black
A - Magna Latch Top Pull Safety Gate Latch	905100 \$138.16
B - External Access Kit Lockable push button operates latch from outside the fence.	905103 \$46.73
C - General Purpose Gate Latch Left or Right Hinge	905102 \$61.93
D - Gate Handle	905104 \$12.86
E - Gate Hinge (pair) 4" Includes 2 - heavy duty / self closing gate hinges, snap-on trim & hardware	300746P \$74.49
F - Gate Drop Rod	901040 \$128.00

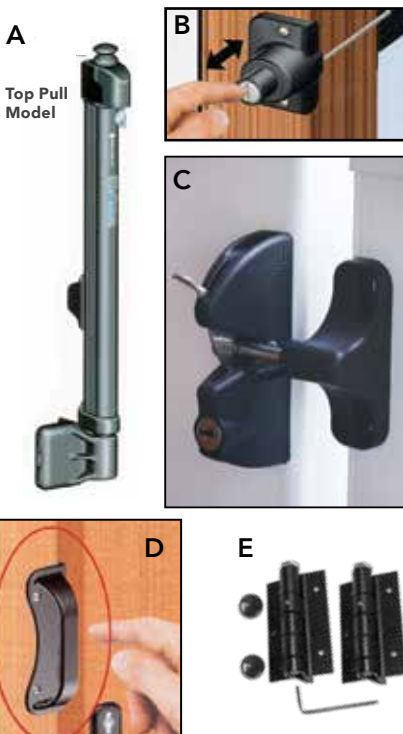

A210 Aluminum Accessories



Flanged Post Kit Includes Cap & Trim



Touch-Up Pen

TIP: A recommended alternative touch-up paint - Rust-oleum Textured Black: Mfr. Model #7220830 - Available at most hardware stores.

Post & Accessories

Item Description	Matte White	Textured Bronze	Textured Black
A - 3" x 3" x 39" Flanged Post Kit (Includes Post Cap & Trim)	306182K \$80.60	306185K \$80.60	306180K \$80.60
A - 3" x 3" x 44" Flanged Post Kit (Includes Post Cap & Trim)	306192K \$91.89	306195K \$91.89	306190K \$91.89
A - 3" x 3" x 54" Flanged Post Kit (Includes Post Cap & Trim)	306202K \$103.90	306205K \$103.90	306200K \$103.90
B - 1-7/8" x 1-7/8" x 34 - 1/4" Post Sleeve (OTP)	306341 \$28.76	306338 \$28.76	306335 \$28.76
B - 1-7/8" x 1-7/8" x 39-3/8" Post Sleeve (OTP)	306342 \$33.80	306339 \$33.80	306336 \$33.80
B - 1-7/8" x 1-7/8" x 54" Post Sleeve (OTP)	306343 \$46.41	306340 \$46.41	306337 \$46.41
B - 4" x 4" x 39" Post Sleeve (PTP)	306361 \$56.00	306362 \$56.00	306360 \$56.00
B - 4" x 4" x 44" Post Sleeve (PTP)	306364 \$69.87	306365 \$69.87	306363 \$69.87
B - 4" x 4" x 108" Post Sleeve (PTP)	306370 \$157.35	306371 \$157.35	306369 \$157.35
C - 3" Post Cap	306172 \$8.19	306175 \$8.19	306170 \$8.19
C - 4" Post Cap	306173 \$10.37	306176 \$10.37	306171 \$10.37
D - 3" Post Base Trim - 2/pc	306162 \$12.56	306165 \$12.56	306160 \$12.56
D - 4" Post Base Trim - 2/pc	306163 \$12.56	306164 \$12.56	306161 \$12.56
D - 1-7/8" Post Trim - 2/pc	306167 \$12.85	306168 \$12.85	306166 \$12.85
E - Touch-Up Paint Pen	307324 \$14.20	307322 \$14.20	307320 \$14.20

Baluster Inserts

Description	ITEM
F - 4' Baluster Insert	306289 \$7.03
F - 6' Baluster Insert	306290 \$10.55
F - 8' Baluster Insert	306292 \$14.06



Structural Post Mounts



Structural Post Mounts	
Description	ITEM
A - 4" x 4" HEAVY-DUTY Structural Post Mount* <ul style="list-style-type: none"> 1.60" square steel post double welded for maximum strength. Includes leveling flange for all surfaces four (4) 5/16" x 1" leveling Screws and leveling shims for non-level surface mounting. Residential/Commercial Top block can be flipped for 42" railing applications. 	401021A \$134.72
B - 4" x 4" STANDARD Structural Post Mount* <ul style="list-style-type: none"> 1.60" square steel post includes leveling shims for non-level surface mounting. Top block can be flipped for 42" railing applications. 	401021 \$90.21
C - 1-7/8" x 1-7/8" x 23-1/4" Surface Mount Post	300695 \$72.37

Structural Post Mount Accessories	
Description	ITEM
D - HEAVY-DUTY Structural Post Mount - Deck Mount Kit** <ul style="list-style-type: none"> Kit Includes: <ul style="list-style-type: none"> One (1) 4-hole top mounting plate, one (1) 8-hole bottom mounting plate, four (4) 3/8" x 6" mounting bolts, eight (8) 3/8" washers, eight (8) 3/8" nuts and four (4) 5/16" x 1" leveling screws. Requires the use of a post trim ring to cover top mounting plate. 	401053 \$30.32
E - Joist Bracket for Structural Post Mounts	401002A \$57.00



A210 Textured Bronze with Horizontal Balusters

* (A) 4" x 4" HEAVY-DUTY Structural Post Mount and (B) 4" x 4" structural post mounts are coated with a heavy duty, two-layer protective textured finish designed and tested to resist corrosion in exterior applications.

** All components of the FAIRWAY® Structural Post Mount - Deck Mount Kit are coated with a three layer (metallic zinc layer, high-grade anti-corrosion chemical conversion film and baked ceramic surface coating), heavy-duty, high-grade metal surface processing technology that resists corrosion in exterior applications.

A210 Aluminum Railing Components & Hardware

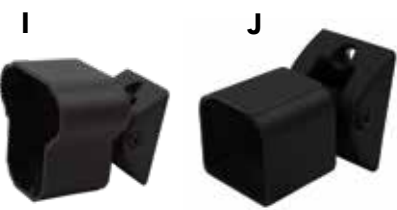
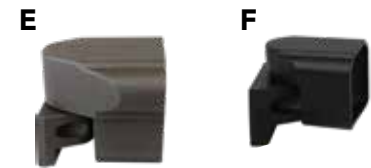

Rail Brackets (Hardware Included)			
Item Description	Matte White	Textured Bronze	Textured Black
A - PTP Top Rail Bracket - Level (2/pk)	306102 \$21.79	306105 \$21.79	306100 \$21.79
B - Bottom Rail Bracket - Level (2/pk)	306112 \$14.72	306115 \$14.72	306110 \$14.72
C - PTP Top Rail Bracket - Fixed Pitch Stair 30°-34° (2/pk)	306122 \$24.62	306125 \$24.62	306120 \$24.62
D - Bottom Rail Bracket - Fixed Pitch Stair 30°-34° (2/pk)	306132 \$22.70	306135 \$22.70	306130 \$22.70
E - PTP Top Rail Bracket - Multi-Angle Level (1/pk)	306142 \$33.93	306145 \$33.93	306140 \$33.93
F - Bottom Rail Bracket - Multi-Angle Level (1/pk)	306152 \$26.73	306155 \$26.73	306150 \$26.73
G - OTP Top Rail Bracket - Line (1/pk)	306326 \$33.93	306324 \$33.93	306322 \$33.93
H - OTP Top Rail Bracket End Cap (1/pk)	306332 \$10.93	306330 \$10.93	306328 \$10.93
I - PTP Top Rail Bracket Multi Pitch Stair (2/pk) 0°-40°	306318 \$20.31	306314 \$20.31	306310 \$20.31
J - PTP Bottom Rail Bracket Multi Pitch Stair (2/pk) 0°-40°	306320 \$22.71	306316 \$22.71	306312 \$22.71
K - Rail Support	306301 \$9.37	306302 \$9.37	306300 \$9.37

PLEASE NOTE WHEN ORDERING OTP (OVER-THE-POST) BRACKETS YOU MUST USE A 1-7/8" POST.

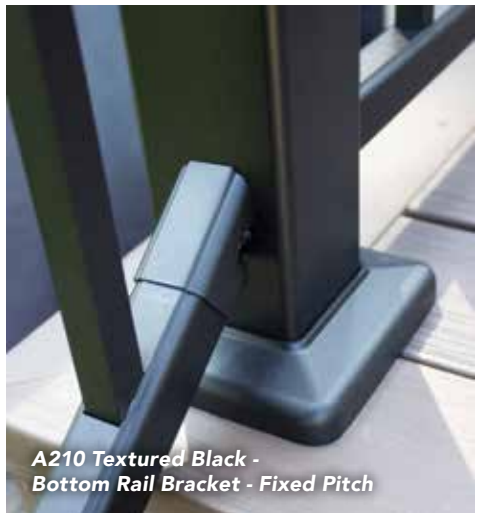

A210 Aluminum Railing Replacement Components



Level

Stair

***PRICE SHOWN IS FOR ONE (1) GLASS SLAT, HOWEVER SLATS ARE ONLY SOLD IN PACKS OF FIVE (5). "EACH" PRICE X 5 = YOUR COST.**

Replacement Glass Slats*

Item Description	Clear
A - 4" x 5/16" x 32" Clear Tempered Glass Slats - Level	301372 \$15.86/ea.
A - 4" x 5/16" x 38" Clear Tempered Glass Slats - Level	301373 \$18.59/ea.
B - 4" x 5/16" x 32-1/4" Clear Tempered Glass Slats - Stair	301384 \$17.22/ea.
B - 4" x 5/16" x 40" Clear Tempered Glass Slats - Stair	301386 \$19.74/ea.

Replacement Baluster Shoes

Item Description	White	Black
C - 4" Glass Baluster Connector Shoe - Level (2/pk)	301381W \$13.80	301381 \$13.80
C - 4" Glass Baluster Connector Shoe - Stair (2/pk)	301387W \$15.19	301387 \$15.19

Replacement Balusters

Item Description	Matte White	Textured Bronze	Textured Black
32-3/4" Square Aluminum Baluster	306212 \$6.51	306215 \$6.51	306210 \$6.51
38-3/4" Square Aluminum Baluster	306222 \$8.42	306225 \$8.42	306220 \$8.42

C



Level

Stair



A210 Textured Black with Square Balusters

A210 Aluminum Railing Replacement Components

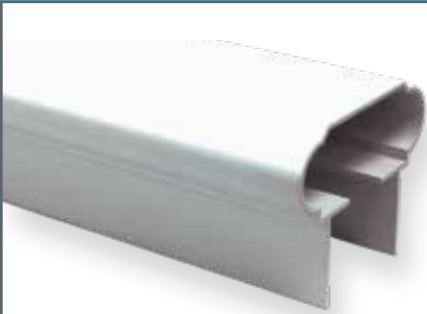

A200 Aluminum Top Rail



A200 Aluminum Sub-Rail*

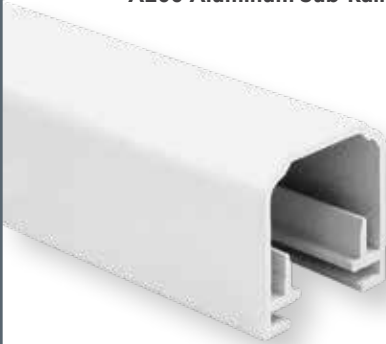

A200 Aluminum Bottom Rail*

***BALUSTER INSERTS SOLD SEPERATELY. SEE PAGE 37 FOR DETAILS.**

Replacement Aluminum Rails

Item Description	Matte White	Textured Bronze	Textured Black
4' Top Rail	306229 \$44.71	306228 \$44.71	306227 \$44.71
6' Top Rail	306236 \$67.76	306235 \$67.76	306230 \$67.76
8' Top Rail	306266 \$90.18	306265 \$90.18	306260 \$90.18
4' Blank Bottom/Sub Rail*	306397 \$29.38	306398 \$29.38	306396 \$29.38
6' Blank Bottom/Sub Rail*	306391 \$37.91	306392 \$37.91	306390 \$37.91
8' Blank Bottom/Sub Rail*	306394 \$58.76	306395 \$58.76	306393 \$58.76
4' Level Bottom/Sub Rail for Square Balusters*	306239 \$28.85	306238 \$28.85	306237 \$28.85
6' Level Bottom/Sub Rail for Square Balusters*	306246 \$43.95	306245 \$43.95	306240 \$43.95
8' Level Bottom/Sub Rail for Square Balusters*	306276 \$58.79	306275 \$58.79	306270 \$58.79
4' Stair Bottom/Sub Rail for Square Balusters*	306287 \$29.33	306281 \$29.33	306277 \$29.33
6' Stair Bottom/Sub Rail for Square Balusters*	306288 \$43.95	306282 \$43.95	306278 \$43.95
8' Stair Bottom/Sub Rail for Square Balusters*	306286 \$58.79	306285 \$58.79	306280 \$58.79



A210 Textured Bronze with Horizontal Balusters

A210 Aluminum Railing Replacement Components

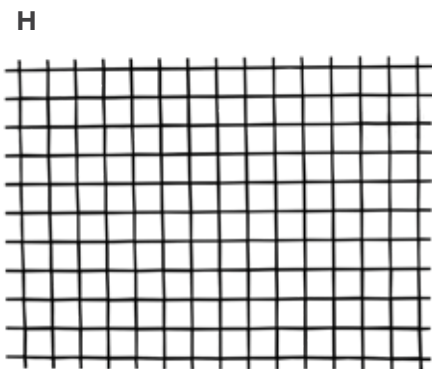
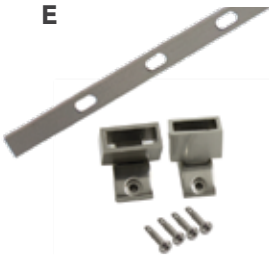
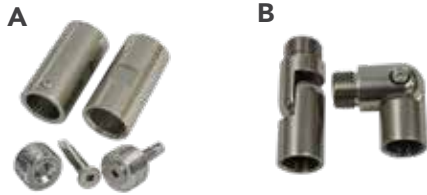

Horizontal Baluster Brackets & Horizontal Balusters

Item Description	Anodized	Textured Black
A - Horizontal Baluster Bracket & Hardware - Level	203005 \$22.66	203004 \$22.66
B - Horizontal Baluster Adapter & Hardware - Stair NOTE: Must be used in conjunction with (A), item 401021A	203007 \$44.06	203006 \$44.06
C - 6' Horizontal Baluster	203000 \$33.85	203002 \$33.85
C - 8' Horizontal Baluster	203001 \$45.67	203003 \$45.67
D - Horizontal Intermediate Baluster & Hardware - Level	203009 \$135.28	203008 \$135.28
E - Horizontal Intermediate Baluster & Hardware - Stair	203011 \$147.52	203010 \$147.52

Tool & Template

Item Description	Item
F - Horizontal Baluster Installation Tool	203013 \$5.60
G - Horizontal Baluster Drill Template	203012 \$36.42

Wire Mesh Infill Panels

Item Description	Mill	Black
H - 6' x 36" x 3" Wire Mesh Infill Panel	209008 \$259.99	209002 \$259.99
H - 8' x 36" x 3" Wire Mesh Infill Panel	209010 \$350.99	209004 \$350.99
H - 6' x 42" x 3" Wire Mesh Infill Panel	209009 \$311.99	209003 \$311.99
H - 8' x 42" x 3" Wire Mesh Infill Panel	209011 \$416.99	209005 \$416.99



A210 Textured Black with Square Balusters

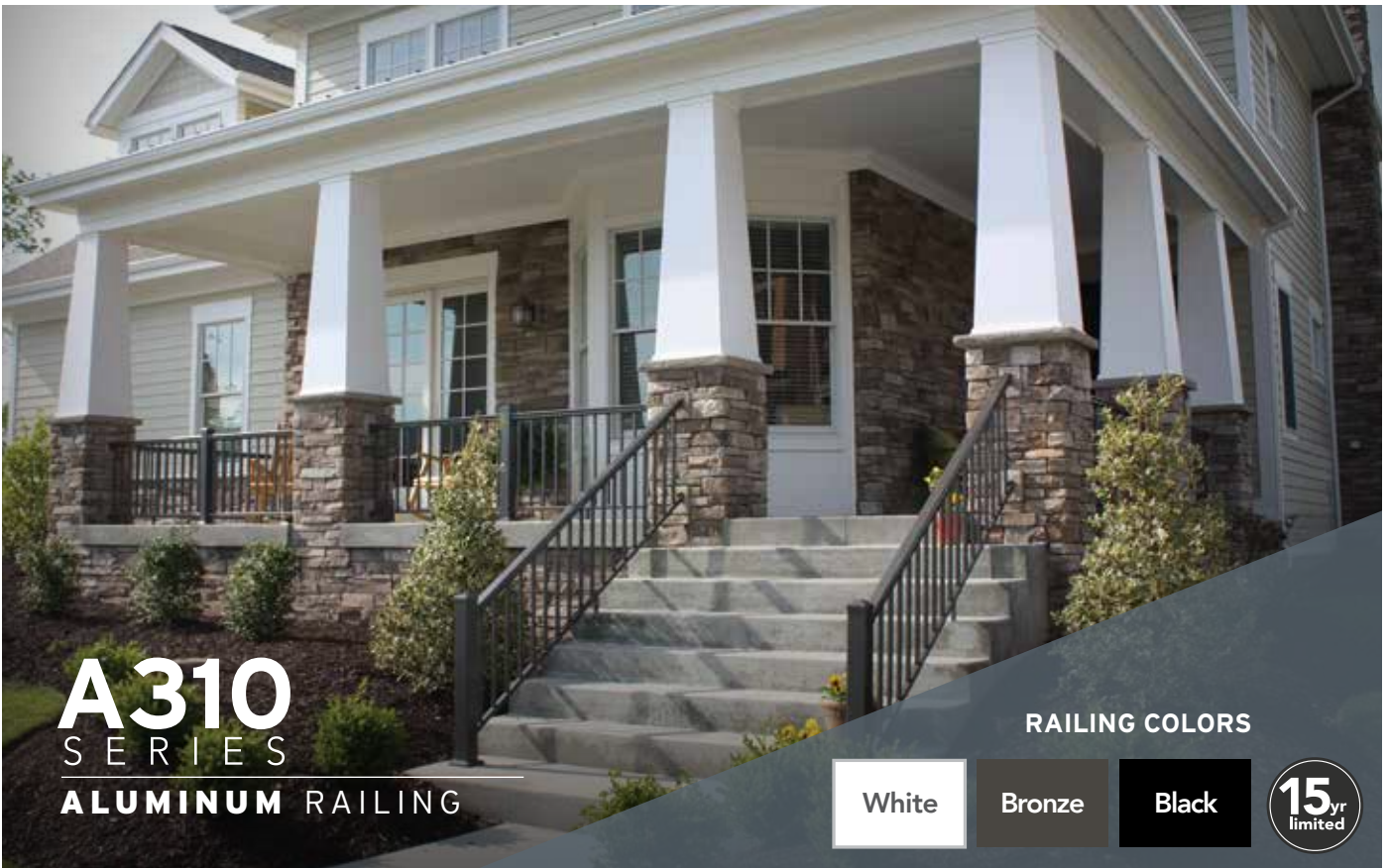

A310

SERIES

ALUMINUM RAILING

RAILING COLORS



FEATURES & BENEFITS

- Versatile Railing System - Choose from Post-To-Post, Over-The-Post Or Fascia Mount Installation Methods
- AAMA-2604 Powder Coated For Sustained Durability
- Refined, Modern Profile - Won't Obstruct Your View
- Durable & Fade Resistant - Withstands Extreme Weather Conditions
- ADA Secondary Handrail Available In Matching Colors

INFILL OPTIONS

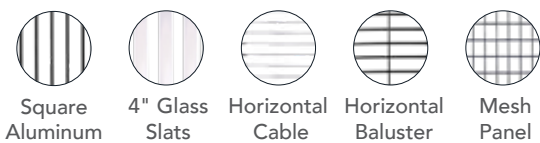

RAILING HEIGHTS

36" Residential • 42" Commercial
Meets ASTM E935 & E985 Standards

RAILING LENGTHS*

4, 6', 8' Level • 4, 6, 8' Stair

KITS INCLUDE

Top & Bottom Rails, Balusters/Infill,
Mounting Brackets & Hardware†

AAMA 2604 Compliant Powder Coating

15-Year Limited Warranty

* Available Lengths Depend On Choice Of Infill.

† Top Brackets Sold Separately

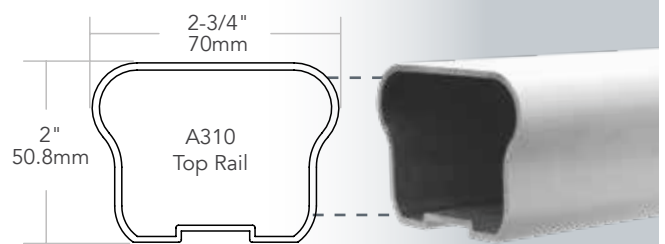

Top Rail

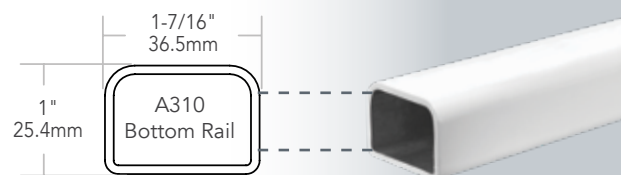

Bottom Rail

A300 RAILING INSTALLATION OPTIONS



Post to Post (PTP)

POST TO POST - PTP

A300 PTP application method is the traditional installation method where the rail terminates into the face of posts.



Over The Post (OTP) Surface Mount

OVER THE POST - OTP

A300 OTP application method provides clean uninterrupted run of the top rail using a wide variety of OTP top rail brackets that are designed to insert into the top of the posts.



Over The Post (OTP) Side/Fascia Mount

OVER THE POST - OTP SIDE/FASCIA MOUNT

A300 OTP Side/Fascia Mount application method installs on the outside band of your structure to address design and structural considerations while making use of every inch of your outdoor space.



POST MOUNTING OPTIONS



3-1/2" FLANGED POST



1-7/8" SURFACE MOUNT POST



3-1/2" SURFACE MOUNT POST



SIDE/FASCIA MOUNT POST

Shown with a 1-7/8" post sleeve and installed on deck side.

STAIR RAIL OPTIONS

MULTI-PITCH STAIR KIT 5° - 38° ANGLE ADJUSTABILITY

Swivel baluster connector installs in rail channel allowing for a wide range of pitch angles.

No angle cutting required.



FIXED-PITCH STAIR KIT 30° - 34° ANGLE ADJUSTABILITY

No angle cutting required.

Designed to eliminate complex and time consuming miter and angle cuts.



A310 Aluminum Railing Kits



KIT INCLUDES:

- Top Rail w/Baluster Connectors
- Bottom Rail w/Baluster Connectors
- 3/4" Square Aluminum Balusters
- Bottom Rail Brackets
- Rail Support - Surface Mount

Caps, Trim and Top Rail Brackets
Sold Separately

Square Aluminum Baluster Kits - LEVEL

Height	Length	White	Bronze	Black
36"	4'	300842 \$136.00	300848 \$136.00	300836 \$136.00
36"	6'	300844 \$204.00	300850 \$204.00	300838 \$204.00
36"	8'	300846 \$272.00	300852 \$272.00	300840 \$272.00
42"	4'	300860 \$149.60	300866 \$149.60	300854 \$149.60
42"	6'	300862 \$224.40	300868 \$224.40	300856 \$224.40
42"	8'	300864 \$299.20	300870 \$299.20	300858 \$299.20

Square Aluminum Baluster Kits - Fixed Pitch - STAIR 30°- 34°

Height	Length	White	Bronze	Black
36"	4'	300915 \$136.00	300921 \$136.00	300909 \$136.00
36"	6'	300917 \$204.00	300923 \$204.00	300911 \$204.00
36"	8'	300919 \$272.00	300925 \$272.00	300913 \$272.00
42"	4'	300933 \$149.60	300939 \$149.60	300927 \$149.60
42"	6'	300935 \$224.40	300941 \$224.40	300929 \$224.40
42"	8'	300937 \$299.20	300943 \$299.20	300931 \$299.20



**Square Aluminum Baluster Kits - Fixed pitch
ADA Accessibility Ramp 4°-8°**

Height	Length	White	Bronze	Black
36"	4'	302142 \$141.78	302148 \$141.78	302136 \$141.78
36"	6'	302144 \$212.67	302150 \$212.67	302138 \$212.67
36"	8'	302146 \$283.56	302152 \$283.56	302140 \$283.56
42"	4'	302160 \$155.96	302166 \$155.96	302154 \$155.96
42"	6'	302162 \$233.94	302168 \$233.94	302156 \$233.94
42"	8'	302164 \$311.92	302170 \$311.92	302158 \$311.92

A310 Aluminum Railing Kits



KIT INCLUDES:

- Top Rail w/Glass Slats Shoes
- Bottom Rail w/Glass Slats Shoes
- 4" Tempered Glass Slats
- Bottom Rail Brackets
- Rail Support - Surface Mount

Posts, Caps, Trim and Top Rail Brackets Sold Separately

4" Glass Slat Kits - LEVEL

Height	Length	White	Bronze	Black
36"	4'	302002 \$268.69	302004 \$268.69	302000 \$268.69
36"	6'	302008 \$403.04	302010 \$403.04	302006 \$403.04
36"	8'	302014 \$537.39	302016 \$537.39	302012 \$537.39
42"	4'	302038 \$295.56	302040 \$295.56	302036 \$295.56
42"	6'	302044 \$443.35	302046 \$443.35	302042 \$443.35
42"	8'	302050 \$591.13	302052 \$591.13	302048 \$591.13

4" Glass Slat Kits - Fixed Pitch - STAIR 32°- 36°

Height	Length	White	Bronze	Black
36"	4'	302020 \$321.25	302022 \$321.25	302018 \$321.25
36"	6'	302026 \$481.87	302028 \$481.87	302024 \$481.87
36"	8'	302032 \$642.50	302034 \$642.50	302030 \$642.50
42"	4'	302056 \$353.37	302058 \$353.37	302054 \$353.37
42"	6'	302062 \$530.06	302064 \$530.06	302060 \$530.06
42"	8'	302068 \$706.75	302070 \$706.75	302066 \$706.75



KIT INCLUDES:

- Blank Top Rail
- Blank Bottom Rail
- Mounting Brackets w/Screws
- Rail Support - Surface Mount

Post, Caps and Trim Sold Separately Sold Separately

Cable Infill Rail Kits - LEVEL

Height	Length	White	Bronze	Black
36" & 42"	6'	201600 \$111.14	201601 \$111.14	201602 \$111.14
36" & 42"	8'	201603 \$136.83	201604 \$136.83	201605 \$136.83

Cable Infill Rail Kits - STAIR

Height	Length	White	Bronze	Black
36" & 42"	6'	201610 \$121.70	201611 \$121.70	201612 \$121.70
36" & 42"	8'	201613 \$149.83	201614 \$149.83	201615 \$149.83

***FOR OTP APPLICATION, POST, CAPS, AND TRIM SOLD SEPARATELY. THIS APPLICATION REQUIRES 1-7/8" POST SLEEVES (PRE-DRILLED IS SPECIAL ORDER). SEE PAGES 143 & 144 FOR ALL HORIZONTAL CABLE COMPONENTS AND ACCESSORIES NOT INCLUDED IN KIT.**

A310 Aluminum Railing Kits



KIT INCLUDES:

- Top Rail
- Bottom Rail
- Intermediate Baluster
- 5/8" Round Aluminum Balusters w/ Brackets
- Mounting Brackets w/Screws
- Rail Support - Surface Mount

Posts, Caps and Trim Sold Separately

PLEASE NOTE: Horizontal Baluster Stair Adapters are available for level angle installatons. See page 58 for details.

Anodized Horizontal Baluster Kits - LEVEL - WITH BOTTOM RAIL

Height	Length	White	Bronze	Black
36"	6'	204100A \$502.00	204200A \$502.00	204300A \$502.00
36"	8'	204101A \$669.33	204201A \$669.33	204301B \$669.33
42"	6'	204150A \$577.30	204250A \$577.30	204350A \$577.30
42"	8'	204151A \$769.73	204251A \$769.73	204351A \$769.73

Anodized Horizontal Baluster Kits - STAIR - WITH BOTTOM RAIL

Height	Length	White	Bronze	Black
36"	6'	204102A \$621.35	204202A \$621.35	204302A \$621.35
36"	8'	204103A \$805.04	204203A \$805.04	204303A \$805.04
42"	6'	204152A \$727.43	204252A \$727.43	204352A \$727.43
42"	8'	204153A \$938.67	204253A \$938.67	204353A \$938.67

CUSTOM PROJECT?

Horizontal Baluster Infill Kits are available for vinyl, composite and wood railing. See page 146 for details.



KIT INCLUDES:

- Top Rail
- Bottom Rail
- Intermediate Baluster
- 5/8" Round Aluminum Balusters w/ Brackets
- Mounting Brackets w/Screws
- Rail Support - Surface Mount

Posts, Caps and Trim Sold Separately

PLEASE NOTE: Horizontal Baluster Stair Adapters are available for level angle installatons. See page 58 for details.

Black Horizontal Baluster Kits - LEVEL - WITH BOTTOM RAIL

Height	Length	White	Bronze	Black
36"	6'	204100B \$502.00	204200B \$502.00	204300B \$502.00
36"	8'	204101B \$669.33	204201B \$669.33	204301B \$669.33
42"	6'	204150B \$577.30	204250B \$577.30	204350B \$577.30
42"	8'	204151B \$769.73	204251B \$769.73	204351B \$769.73

Black Horizontal Baluster Kits - STAIR - WITH BOTTOM RAIL

Height	Length	White	Bronze	Black
36"	6'	204102B \$621.35	204202B \$621.35	204302B \$621.35
36"	8'	204103B \$805.04	204203B \$805.04	204303B \$805.04
42"	6'	204152B \$727.43	204252B \$727.43	204352B \$727.43
42"	8'	204153B \$938.67	204253B \$938.67	204353B \$938.67

CUSTOM PROJECT?

Horizontal Baluster Infill Kits are available for vinyl, composite and wood railing. See page 146 for details.

A310 Aluminum Railing Kits



KIT INCLUDES:

- Top Rail
- Intermediate Baluster
- 5/8" Round Aluminum Balusters w/ Brackets
- Mounting Brackets w/Screws
- Rail Support - Surface Mount

Posts, Caps and Trim Sold Separately

PLEASE NOTE: Horizontal Baluster Stair Adapters are available for level angle installatons. See page 58 for details.

Anodized Horizontal Baluster Kits - LEVEL - WITHOUT BOTTOM RAIL

Height	Length	White	Bronze	Black
36"	6'	204104A \$502.00	204204A \$502.00	204304A \$502.00
36"	8'	204105A \$669.33	204205A \$669.33	204305A \$669.33
42"	6'	204154A \$577.30	204254A \$577.30	204354A \$577.30
42"	8'	204155A \$769.73	204255A \$769.73	204355A \$769.73

Anodized Horizontal Baluster Kits - STAIR - WITHOUT BOTTOM RAIL

Height	Length	White	Bronze	Black
36"	6'	204106A \$621.35	204206A \$621.35	204306A \$621.35
36"	8'	204107A \$805.04	204207A \$805.04	204307A \$805.04
42"	6'	204156A \$727.43	204256A \$727.43	204356A \$727.43
42"	8'	204157A \$938.67	204257A \$938.67	204357A \$938.67

CUSTOM PROJECT?

Horizontal Baluster Infill Kits are available for vinyl, composite and wood railing. See page 146 for details.



KIT INCLUDES:

- Top Rail
- Intermediate Baluster
- 5/8" Round Aluminum Balusters w/ Brackets
- Mounting Brackets w/Screws
- Rail Support - Surface Mount

Posts, Caps and Trim Sold Separately

PLEASE NOTE: Horizontal Baluster Stair Adapters are available for level angle installatons. See page 58 for details.

Black Horizontal Baluster Kits - LEVEL - WITHOUT BOTTOM RAIL

Height	Length	White	Bronze	Black
36"	6'	204104B \$502.00	204204B \$502.00	204304B \$502.00
36"	8'	204105B \$669.33	204205B \$669.33	204305B \$669.33
42"	6'	204154B \$577.30	204254B \$577.30	204354B \$577.30
42"	8'	204155B \$769.73	204255B \$769.73	204355B \$769.73

Black Horizontal Baluster Kits - STAIR - WITHOUT BOTTOM RAIL

Height	Length	White	Bronze	Black
36"	6'	204106B \$621.35	204206B \$621.35	204306B \$621.35
36"	8'	204107B \$805.04	204207B \$805.04	204307B \$805.04
42"	6'	204156B \$727.43	204256B \$727.43	204356B \$727.43
42"	8'	204157B \$938.67	204257B \$938.67	204357B \$938.67

CUSTOM PROJECT?

Horizontal Baluster Infill Kits are available for vinyl, composite and wood railing. See page 146 for details.

A310 Aluminum Railing Kits



Mill Mesh Infill Kits - LEVEL

Height	Length	White	Bronze	Black
36"	6'	209220 \$368.00	209210 \$368.00	209200 \$368.00
36"	8'	209221 \$490.67	209211 \$490.67	209201 \$490.67
42"	6'	209222 \$404.80	209212 \$404.80	209202 \$404.80
42"	8'	209223 \$539.73	209213 \$539.73	209203 \$539.73

KIT INCLUDES:

- Top Rail
- Bottom Rail
- Square Aluminum Side Stiles
- Stile Connectors
- Mesh Infill Panel
- Mounting Brackets w/Screws
- Rail Support - Surface Mount

Post, Caps and Trim Sold Separately

HORIZONTAL BALUSTER STAIR KITS ARE A RECOMMENDED COORDINATE FOR STAIR APPLICATIONS. SEE PAGES 47 & 48.

CUSTOM PROJECT?

Mesh Panel Infill Kits are available for vinyl, composite and wood railing. See page 146 for details.



Black Mesh Infill Kits - LEVEL

Height	Length	White	Bronze	Black
36"	6'	209224 \$368.00	209214 \$368.00	209204 \$368.00
36"	8'	209225 \$490.67	209215 \$490.67	209205 \$490.67
42"	6'	209226 \$404.80	209216 \$404.80	209206 \$404.80
42"	8'	209227 \$539.73	209217 \$539.73	209207 \$539.73

KIT INCLUDES:

- Top Rail
- Bottom Rail
- Square Aluminum Side Stiles
- Stile Connectors
- Mesh Infill Panel
- Mounting Brackets w/Screws
- Rail Support - Surface Mount

Post, Caps and Trim Sold Separately

HORIZONTAL BALUSTER STAIR KITS ARE A RECOMMENDED COORDINATE FOR STAIR APPLICATIONS. SEE PAGES 47 & 48.

CUSTOM PROJECT?

Mesh Panel Infill Kits are available for vinyl, composite and wood railing. See page 146 for details.



A310 SERIES

ALUMINUM RAILING
RAILING ACCESSORIES

5/1

ALUMINUM GATES & ACCESSORIES

5/2

ALUMINUM ACCESSORIES

5/4

STRUCTURAL POST MOUNTS

5/5

ALUMINUM COMPONENTS & HARDWARE

5/6

ALUMINUM REPLACEMENT COMPONENTS

PLEASE NOTE WHEN ORDERING OTP (OVER-THE-POST) BRACKETS YOU MUST USE A 1-7/8" POST.



*A310 Black
with Square Balusters*

A310 Aluminum Railing Gates & Accessories



Square



Horizontal Baluster



Mesh

All Gates Are Fully Assembled & Include:

- 2 - Adjustable self-closing hinges & screws
- 1 - Lockable latch

GATE TIP: Add 1-1/2" to the published gate width for a perfect fit. Custom gates available.

Aluminum Railing Gates with Square Aluminum Balusters

Item Description	White	Bronze	Black
34-1/2"w x 36"h Railing Gate	300966 \$420.83	300968 \$420.83	300964 \$420.83
34-1/2"w x 42"h Railing Gate	300972 \$462.91	300974 \$462.91	300970 \$462.91

Aluminum Railing Gates with Horizontal Balusters

Item Description	White		Bronze		Black	
	Anodized	Tex. Black	Anodized	Tex. Black	Anodized	Tex. Black
34-1/2"w x 36"h Railing Gate	302180 \$608.85	302179 \$608.85	302178 \$608.85	302177 \$608.85	302176 \$608.85	302175 \$608.85
34-1/2"w x 42"h Railing Gate	302186 \$710.35	302185 \$710.35	302184 \$710.35	302183 \$710.35	302182 \$710.35	302181 \$710.35

Aluminum Railing Gates with Mesh

Item Description	White		Bronze		Black	
	Mill	Tex. Black	Mill	Tex. Black	Mill	Tex. Black
34-1/2"w x 36"h Railing Gate	302192 \$608.85	302191 \$608.85	302190 \$608.85	302189 \$608.85	302188 \$608.85	302187 \$608.85
34-1/2"w x 42"h Railing Gate	302198 \$710.35	302197 \$710.35	302196 \$710.35	302195 \$710.35	302194 \$710.35	302193 \$710.35

Gate Accessories

Item Description	Black
A - Magna Latch Top Pull Safety Gate Latch	905100 \$138.16
B - External Access Kit Lockable push button operates latch from outside the fence.	905103 \$46.73
C - General Purpose Gate Latch Left or Right Hinge	905102 \$61.93
D - Gate Handle	905104 \$12.86
E - Gate Hinge (pair) 4" Includes 2 - heavy duty / self closing gate hinges, snap-on trim & hardware	300746P \$74.49
F - Gate Drop Rod	901040 \$128.00

A
Top Pull
Model

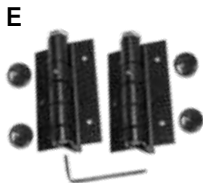

A310 Aluminum Accessories

A
FLANGED POST
 Post insert not required

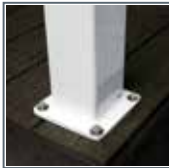

*** FOR PRE-DRILLED
 CABLE POST SLEEVES SEE PAGE 138**

B
POST SLEEVE
 Post insert required



Flanged Posts

Item Description	White	Bronze	Black
A - 3-1/2" x 3-1/2" x 39" Flanged Post	300334 \$100.27	300336 \$100.27	300332 \$100.27
A - 3-1/2" x 3-1/2" x 44" Flanged Post	300328 \$105.41	300330 \$105.41	300326 \$105.41
A - 3-1/2" x 3-1/2" x 54" Flanged Post	300322 \$118.27	300324 \$118.27	300320 \$118.27

Post Sleeves*

Item Description	White	Bronze	Black
B - 1-7/8" x 1-7/8" x 34-1/4" Post Sleeve (OTP)	300295 \$29.31	300300 \$29.31	300290 \$29.31
B - 1-7/8" x 1-7/8" x 39-3/8" Post Sleeve (OTP)	300310 \$34.45	300315 \$34.45	300305 \$34.45
B - 1-7/8" x 1-7/8" x 54" Post Sleeve (OTP)	300400 \$46.41	300405 \$46.41	300395 \$46.41
B - 3-1/2" x 3-1/2" x 39" Post Sleeve (PTP) • Must Use Surface Mount Post - Item # 300700	300355 \$34.86	300360 \$34.86	300350 \$34.86
B - 3-1/2" x 3-1/2" x 44" Post Sleeve (PTP) • Must Use Surface Mount Post - Item # 300700	300370 \$62.95	300375 \$62.95	300365 \$62.95
B - 3-1/2" x 3-1/2" x 54" Post Sleeve (PTP) • Must Use Surface Mount Post - Item # 300700	300385 \$79.12	300390 \$79.12	300380 \$79.12
B - 4" x 4" x 39" Post Sleeve (PTP) • Sleeves Over Nominal 4" x 4" Post	300356 \$56.00	300361 \$56.00	300351 \$56.00
B - 4" x 4" x 44" Post Sleeve (PTP) • Sleeves Over Nominal 4" x 4" Post	300371 \$69.87	300376 \$69.87	300366 \$69.87
B - 4" x 4" x 108" Post Sleeve (PTP) • Sleeves Over Nominal 4" x 4" Post	300392 \$157.35	300393 \$157.35	300391 \$157.35



A310 Bronze with Square Balusters

A310 Aluminum Accessories

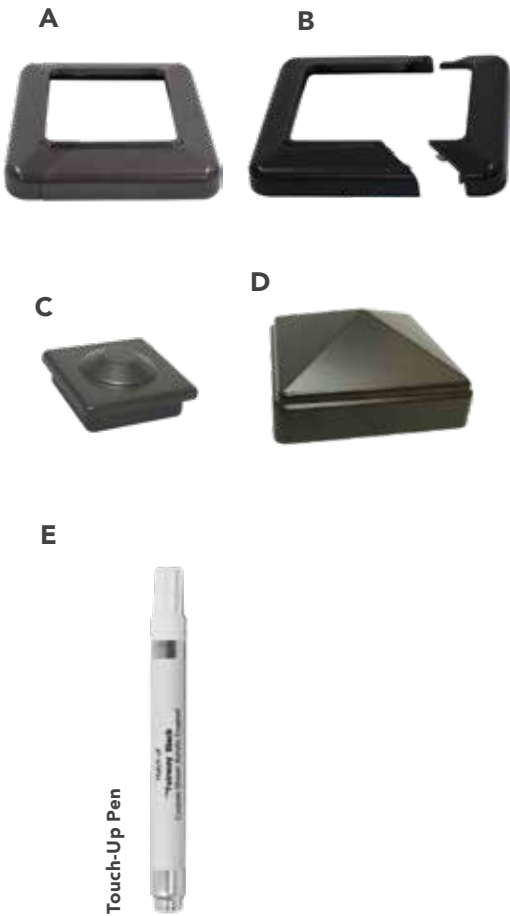

Post Accessories

Item Description	White	Bronze	Black
A - 1-7/8" Post Base Trim - (1pc.)	300340 \$8.53	300342 \$8.53	300338 \$8.53
A - 3-1/2" Post Base Trim - (1pc.)	300346 \$11.03	300348 \$11.03	300344 \$11.03
A - 4" Post Base Trim - (1pc.)	300536 \$17.85	300541 \$17.85	300531 \$17.85
B - 1-7/8" Post Base Trim - (2pc.)	300520 \$12.85	300525 \$12.85	300515 \$12.85
B - 3-1/2" Post Base Trim - (2pc.)	300535 \$17.85	300540 \$17.85	300530 \$17.85
C - 1-7/8" Post Cap	300610 \$10.93	300615 \$10.93	300605 \$10.93
D - 3-1/2" Post Cap	300640 \$8.82	300645 \$8.82	300635 \$8.82
D - 4" Post Cap	300641 \$9.85	300646 \$9.85	300636 \$9.85

Accessories

Item Description	White	Bronze	Black
E - Touch-Up Paint Pen	307324 \$14.20	307322 \$14.20	307320 \$14.20



A310 Railing Structural Post Mounts

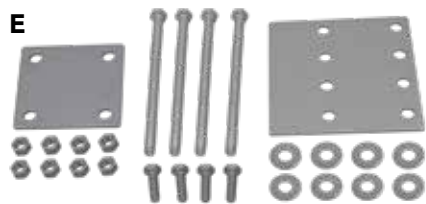

Structural Post Mounts	
Description	ITEM
A - 4" x 4" HEAVY-DUTY Structural Post Mount* <ul style="list-style-type: none"> 1.60" square steel post double welded for maximum strength. Includes leveling flange for all surfaces, four (4) 5/16" x 1" leveling Screws and leveling shims for non-level surface mounting. Residential/Commercial Top block can be flipped for 42" railing applications. 	401021A \$134.72
B - 4" x 4" STANDARD Structural Post Mount* <ul style="list-style-type: none"> 1.60" square steel post includes leveling shims for non-level surface mounting. Top block can be flipped for 42" railing applications. 	401021 \$90.21
C - 1-7/8" x 1-7/8" x 23-1/4" Surface Post Mount	300695 \$72.37
C - 3-1/2" x 3-1/2" x 23-1/4" Surface Post Mount	300700 \$56.99
D - 1-7/8" x 1-7/8" x 31" Side/Fascia Post Mount	300705 \$64.02

Structural Post Mounts Accessories	
Description	ITEM
E - HEAVY-DUTY Structural Post Mount - Deck Mount Kit** <ul style="list-style-type: none"> Kit Includes: <ul style="list-style-type: none"> One (1) 4-hole top mounting plate, one (1) 8-hole bottom mounting plate, four (4) 3/8" x 6" mounting bolts, eight (8) 3/8" washers, eight (8) 3/8" nuts and four (4) 5/16" x 1" leveling screws. Requires the use of a post trim ring to cover top mounting plate. 	401053 \$30.32
F - Joist Bracket for Structural Post Mounts	401002A \$57.00

Side/Fascia Mount Brackets			
Item Description	White	Bronze	Black
G - Side/Fascia Mount - Rail Support	300670 \$19.83	300675 \$19.83	300665 \$19.83
H - Side/Fascia Mount Post Hardware Cover	300720 \$16.82	300725 \$16.82	300715 \$16.82
I - Corner Mount Post - Side/Fascia Bracket	N/A	N/A	300710 \$63.31
I - Corner Mount Post - Bracket Cover	300625 \$22.34	300630 \$22.34	300620 \$22.34

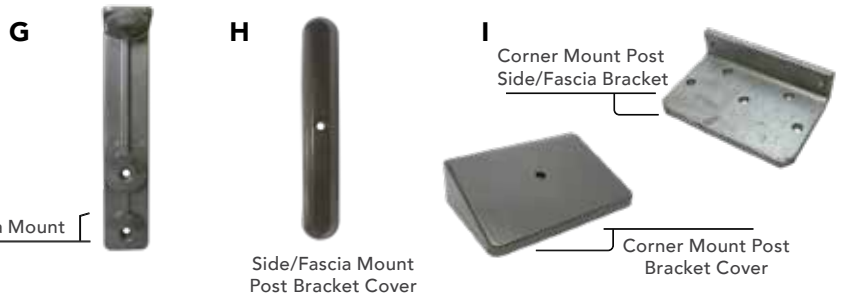

* (A) 4" x 4" HEAVY-DUTY Structural Post Mount and (B) 4" x 4" structural post mounts are coated with a heavy duty, two-layer protective textured finish designed and tested to resist corrosion in exterior applications.

** All components of the FAIRWAY® Structural Post Mount - Deck Mount Kit are coated with a three layer (metallic zinc layer, high-grade anti-corrosion chemical conversion film and baked ceramic surface coating), heavy-duty, high-grade metal surface processing technology that resists corrosion in exterior applications.

A310 Aluminum Railing Components & Hardware

PTP (Top Rail)

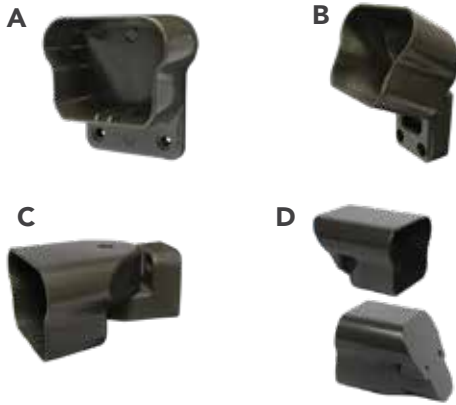

OTP (Top Rail)



PTP/OTP (Bottom Rail)



Post To Post (PTP) Top Rail Brackets (Hardware Included)

Item Description	White	Bronze	Black
A - Top Rail Bracket (PTP) - Level (2/pk)	300415 \$11.63	300420 \$11.63	300410 \$11.63
B - Top Tail Bracket (PTP) - Multi-Pitch Stair 5°-38° (2pk)	300445 \$20.31	300450 \$20.31	300440 \$20.31
C - Top Rail Bracket (PTP) - Multi-Angle Level (1/pk)	300580 \$33.93	300585 \$33.93	300575 \$33.93
D - Top Rail Bracket (PTP) - Fixed-Pitch Stair 30°-34° (2pk)	300444 \$23.60	300446 \$23.60	300439 \$23.60

Over The Post (OTP) Top Rail Brackets (Hardware Included)

Item Description	White	Bronze	Black
E - Top Rail End Bracket (OTP) - Level (1/pk)	300475 \$17.90	300480 \$17.90	300470 \$17.90
F - Top Rail 90° Bracket (OTP) - Level (1/pk)	300490 \$13.43	300495 \$13.43	300485 \$13.43
G - Top Rail Line Bracket (OTP) - Level (1/pk)	300505 \$13.43	300510 \$13.43	300500 \$13.43
H - Top Rail T Bracket (OTP) - Level (1/pk)	300685 \$25.45	300690 \$25.45	300680 \$25.45
I - Top Rail Line Bracket (OTP) - Multi-Angle Level (1/pk)	300550 \$25.45	300555 \$25.45	300545 \$25.45
J - Top Rail Line Bracket (OTP) - Multi-Pitch Stair (1/pk)	300595 \$29.85	300600 \$29.85	300590 \$29.85
K - Top Rail End Bracket (OTP) - Multi-Pitch Stair (1/pk)	300452 \$17.03	300453 \$17.03	300451 \$17.03
L - Top Rail End Cap Bracket (OTP) - Multi-Pitch Stair (1/pk)	300602 \$10.93	300603 \$10.93	300601 \$10.93

PTP & OTP Bottom Rail Brackets (Hardware Included)

Item Description	White	Bronze	Black
M - Bottom Rail Bracket (PTP/OTP) Level (2/pk) Included in Level Railing Kit	300430 \$11.63	300435 \$11.63	300425 \$11.63
N - Bottom Rail Bracket (PTP/OTP) Multi-Pitch Stair (2/pk) Included in Multi-Pitch Stair Railing Kit	300460 \$17.03	300465 \$17.03	300455 \$17.03
O - Bottom Rail Bracket (PTP/OTP) Multi-Angle Level (1/pk)	300565 \$26.73	300570 \$26.73	300560 \$26.73
P - Bottom Rail Bracket (PTP/OTP) - Fixed-Pitch Stair 30°-34° (2/pk) Included in Fixed-Pitch Stair Railing Kit	300443 \$22.70	300447 \$22.70	300438 \$22.70

PLEASE NOTE WHEN ORDERING OTP (OVER-THE-POST) BRACKETS YOU MUST USE A 1-7/8" POST.

A310 Aluminum Railing Replacement Components

A



B



E - Replacement top rail for glass balusters (level or stair), fixed pitch stair rails or cable rail.



F - Replacement bottom rail for glass balusters (level or stair), fixed pitch stair rails or cable rail.

Replacement Single Rails w/Installed Baluster Connectors

Item Description	White	Bronze	Black
A - 4' Top Rail - Level	300010 \$63.13	300020 \$63.13	300000 \$63.13
A - 6' Top Rail - Level	300040 \$94.68	300050 \$94.68	300030 \$94.68
A - 8' Top Rail - Level	300070 \$126.24	300080 \$126.24	300060 \$126.24
B - 4' Bottom Rail - Level	300015 \$39.37	300025 \$39.37	300005 \$39.37
B - 6' Bottom Rail - Level	300045 \$59.06	300055 \$59.06	300035 \$59.06
B - 8' Bottom Rail - Level	300075 \$78.75	300085 \$78.75	300065 \$78.75

Replacement Blank Single Rails*

Item Description	White	Bronze	Black
E - 4' Blank Top Rail	300010GL \$53.94	300020GL \$53.94	300000GL \$53.94
E - 6' Blank Top Rail	300040GL \$80.90	300050GL \$80.90	300030GL \$80.90
E - 8' Blank Top Rail	300070GL \$107.87	300080GL \$107.87	300060GL \$107.87
F - 4' Blank Bottom Rail	300015GL \$38.70	300025GL \$38.70	300005GL \$38.70
F - 6' Blank Bottom Rail	300045GL \$58.06	300055GL \$58.06	300035GL \$58.06
F - 8' Blank Bottom Rail	300075GL \$77.41	300085GL \$77.41	300065GL \$77.41

* Single rails are not machined for baluster connectors. Indicate fixed pitch stair, level glass balusters, stair glass balusters or cable rail at time of order.



A310 White with Round Balusters

A310 Aluminum Railing Replacement Components



***PRICE SHOWN IS FOR ONE (1) GLASS SLAT, HOWEVER SLATS ARE ONLY SOLD IN PACKS OF FIVE (5). "EACH" PRICE X 5 = YOUR COST.**

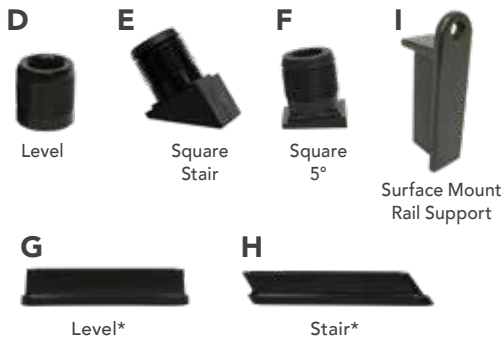

Replacement Aluminum Balusters			
Item Description	White	Bronze	Black
A - 36"h x 3/4" Square Baluster (for 36" h rail)	300260 \$6.51	300265 \$6.51	300255 \$6.51
A - 42"h x 3/4" Square Baluster (for 42" h rail)	300275 \$8.42	300280 \$8.42	300270 \$8.42
Replacement Glass Slats*			
Item Description	Clear		
B - 4" x 5/16" x 32" Clear Tempered Glass Slats - Level	301372 \$15.86 /ea.		
B - 4" x 5/16" x 38" Clear Tempered Glass Slats - Level	301373 \$18.59 /ea.		
C - 4" x 5/16" x 32-1/4" Clear Tempered Glass Slats - Stair	301384 \$17.22 /ea.		
C - 4" x 5/16" x 40" Clear Tempered Glass Slats - Stair	301386 \$19.74 /ea.		
Replacement Baluster Connectors & Shoes (Hardware Included)			
Item Description	White	Bronze	Black
D - Baluster connector - level (20/pk) for round or square balusters	N/A	N/A	301374 \$9.35
E - Square Baluster Connector - Stair (20/pk)	301377W \$13.69	301377BZ \$13.69	301377 \$13.69
F - Square Baluster Connector - 5° (20/pk)	300774 \$13.69	300775 \$13.69	300773 \$13.69
G - 4" Glass Baluster Connector Shoe - Level (2/pk)	301381W \$13.80	301381BZ \$13.80	301381 \$13.80
H - 4" Glass Baluster Connector Shoe - Stair (2/pk)	301387W \$15.19	301387BZ \$15.19	301387 \$15.19
Replacement Rail Support (Hardware Included)			
Item Description	White	Bronze	Black
I - Surface Mount Rail Support	300655 \$8.37	300660 \$8.37	300650 \$8.37



A310 Bronze with Glass Slats

**Hardware is hidden inside of baluster connector shoe*

A310 Aluminum Railing Replacement Components

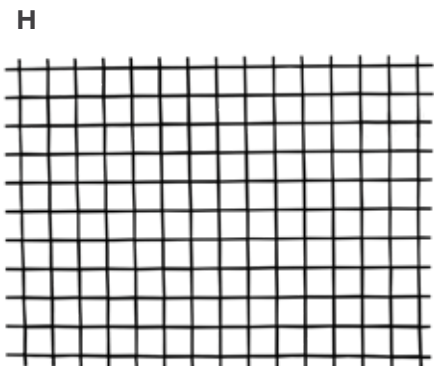
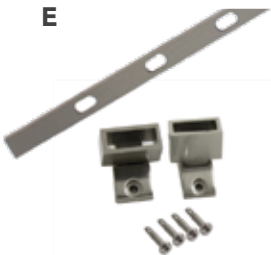
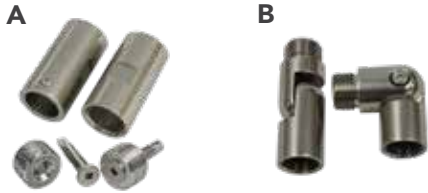

Horizontal Baluster Brackets & Horizontal Balusters

Item Description	Anodized	Textured Black
A - Horizontal Baluster Bracket & Hardware - Level	203005 \$22.66	203004 \$22.66
B - Horizontal Baluster Adapter & Hardware - Stair NOTE: Must be used in conjunction with (A), item 401021A	203007 \$44.06	203006 \$44.06
C - 6' Horizontal Baluster	203000 \$33.85	203002 \$33.85
C - 8' Horizontal Baluster	203001 \$45.67	203003 \$45.67
D - Horizontal Intermediate Baluster & Hardware - Level	203009 \$135.28	203008 \$135.28
E - Horizontal Intermediate Baluster & Hardware - Stair	203011 \$147.52	203010 \$147.52

Tool & Template (Hardware Included)

Item Description	Item
F - Horizontal Baluster Installation Tool	203013 \$5.60
G - Horizontal Baluster Drill Template	203012 \$36.42

Wire Mesh Infill Panels

Item Description	Mill	Black
H - 6' x 36" x 3" Wire Mesh Infill Panel	209008 \$259.99	209002 \$259.99
H - 8' x 36" x 3" Wire Mesh Infill Panel	209010 \$350.99	209004 \$350.99
H - 6' x 42" x 3" Wire Mesh Infill Panel	209009 \$311.99	209003 \$311.99
H - 8' x 42" x 3" Wire Mesh Infill Panel	209011 \$416.99	209005 \$416.99



A310 Bronze with Square Balusters



A310 Bronze with Square Balusters

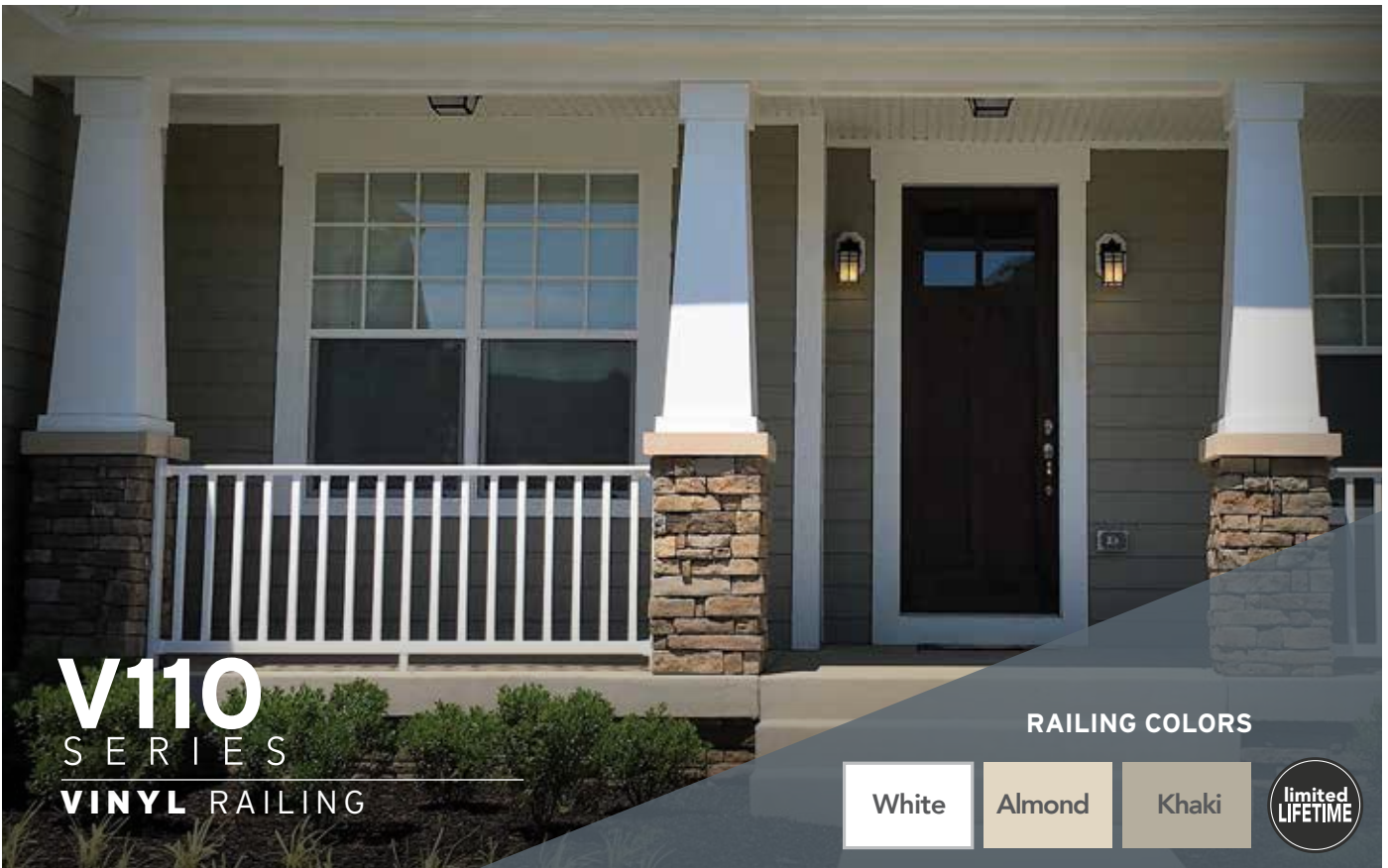

V110

SERIES

VINYL RAILING

RAILING COLORS

White Almond Khaki 

FEATURES & BENEFITS

- Quick & Easy Bracket Installation With Provided Template
- Traditional, Subtle Profile - Won't Obstruct Your View
- Optional **Pre-Drilled Post Sleeves** Delivers A Swift Installation
- ADA Secondary Handrail Available In Matching Colors
- Metal To Metal Attachment - Brackets Attach Directly To Aluminum Inserts In Top & Bottom Rail
- Hidden Hardware Two-Piece Bracket System
- Durable & Fade Resistant - Withstands Extreme Weather Conditions With UV Protection

INFILL OPTIONS



Square Vinyl Turned Vinyl Round Aluminum Horizontal Cable

RAILING HEIGHTS

36" Residential • 42" Commercial
Meets IRC, IBC Standards

RAILING LENGTHS

6', 8', 10' Level • 6', 8' Stair
Aluminum Reinforced Top & Bottom Rail

KITS INCLUDE

Top & Bottom Rails, Balusters/Infill,
Mounting Brackets & Hardware

Limited Lifetime Warranty

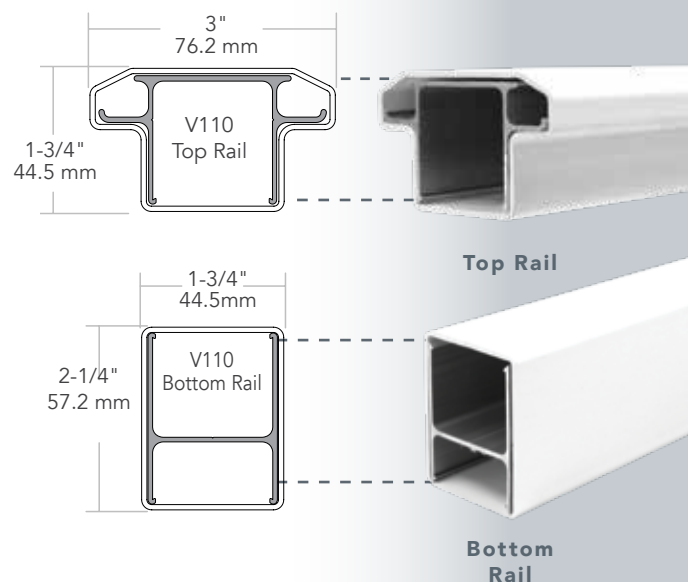

V110 Vinyl Railing Kits



KIT INCLUDES:

- Top Rail w/ Aluminum Insert
- Bottom Rail w/ Aluminum Insert
- Square Vinyl Balusters
- Rail Support (Level)
- Mounting Brackets w/Screws
- Bracket Installation Drill Template

Posts, Caps and Trim Sold Separately

Square Vinyl Baluster Kits - LEVEL

Height	Length	White	Almond	Khaki
36"	6'	400625 \$141.09	430600 \$162.25	400626 \$169.30
36"	8'	400630 \$188.12	430620 \$216.34	400631 \$225.74
36"	10'	400635 \$235.14	430640 \$270.41	400636 \$282.17
42"	6'	400675 \$155.20	430610 \$178.48	400676 \$186.23
42"	8'	400680 \$206.93	430630 \$237.97	400681 \$248.31
42"	10'	400685 \$258.66	430645 \$297.46	400686 \$310.39

Square Vinyl Baluster Kits - STAIR 29°- 35°

Height	Length	White	Almond	Khaki
36"	6'	400640 \$166.32	430601 \$191.27	400641 \$199.59
36"	8'	400645 \$213.35	430621 \$245.35	400646 \$256.02
42"	6'	400690 \$162.36	430611 \$210.39	400691 \$219.54
42"	8'	400695 \$234.69	430631 \$269.89	400696 \$281.62



KIT INCLUDES:

- Top Rail w/ Aluminum Insert
- Bottom Rail w/ Aluminum Insert
- Turned Vinyl Balusters
- Rail Support (Level)
- Mounting Brackets w/Screws
- Bracket Installation Drill Template

Posts, Caps and Trim Sold Separately

Turned Vinyl Baluster Kits - LEVEL

Height	Length	White	Almond	Khaki
36"	6'	400650 \$204.39	430602 \$235.05	400651 \$245.27
36"	8'	400655 \$272.53	430622 \$313.41	400656 \$327.03
36"	10'	400660 \$340.65	430641 \$391.75	400661 \$408.78
42"	6'	400600 \$224.83	430612 \$258.55	400601 \$269.80
42"	8'	400604 \$299.77	430632 \$344.74	400605 \$359.73
42"	10'	400632 \$374.72	430646 \$430.93	400633 \$449.67

Turned Vinyl Baluster Kits - STAIR 29°- 35°

Height	Length	White	Almond	Khaki
36"	6'	400665 \$230.38	430603 \$317.93	400666 \$276.46
36"	8'	400670 \$298.52	430623 \$343.30	400671 \$358.22
42"	6'	400643 \$253.42	430613 \$291.43	400644 \$304.11
42"	8'	400652 \$328.36	430633 \$377.61	400654 \$394.03

V110 Vinyl Railing Kits



KIT INCLUDES:

- Vinyl Top Rail w/ Aluminum Insert
- Vinyl Bottom Rail w/ Aluminum Insert
- Rail Support (Level)
- Mounting Brackets w/Screws

Posts, Caps, Trim and Horizontal Cable Infill Sold Separately

Cable Infill Rail Kits - LEVEL

Height	Length	White	Almond	Khaki
36" & 42"	6'	201300 \$101.52	230006 \$116.75	201301 \$121.82
36" & 42"	8'	201302 \$129.96	230007 \$149.45	201303 \$155.95

Cable Infill Rail Kits - STAIR

Height	Length	White	Almond	Khaki
36" & 42"	6'	201310 \$111.16	230008 \$127.83	201311 \$133.40
36" & 42"	8'	201312 \$142.31	230009 \$163.66	201313 \$170.77

SEE PAGES 143 & 144 FOR ALL HORIZONTAL CABLE COMPONENTS AND ACCESSORIES NOT INCLUDED IN KIT.



V110 White with Square Balusters
*Flags not included

V110 Vinyl Railing Kits



KIT INCLUDES:

- Top Rail w/ Aluminum Insert
- Bottom Rail w/ Aluminum Insert
- Round Aluminum Balusters
- Rail Support (Level)
- Mounting Brackets w/Screws

Post, Caps and Trim Sold Separately

*Assuming 2" bottom rail sweep height the 36" and 42" kits will provide a 35" and 39" finished rail height.







Round Aluminum Baluster Kits - LEVEL

Height	Length	White	Almond	Khaki
36"*	6'	400901(B) \$161.96	430604(B) \$186.25	400902(B) \$194.35
36"*	8'	400903(B) \$215.95	430624(B) \$248.34	400904(B) \$259.14
36"*	10'	400905(B) \$269.93	430642(B) \$309.27	400906(B) \$323.92
42"	6'	400911(B) \$186.25	430614(B) \$214.19	400912(B) \$223.50
42"	8'	400913(B) \$248.34	430634(B) \$285.59	400914(B) \$298.01
42"	10'	400915(B) \$310.42	430647(B) \$356.98	400916(B) \$372.51

Round Aluminum Baluster Kits - STAIR 29°-35°

Height	Length	White	Almond	Khaki
36"*	6'	400907(B) \$187.82	430605(B) \$215.99	400908(B) \$225.39
36"*	8'	400909(B) \$250.43	430625(B) \$287.99	400910(B) \$300.52
42"	6'	400917(B) \$216.00	430615(B) \$248.40	400918(B) \$259.20
42"	8'	400919(B) \$288.00	430635(B) \$331.20	400920(B) \$345.60

Round Aluminum Baluster Kits ship with black balusters. To receive balusters in the color of your choice, replace (B) in item number with the color letter shown.

 Bronze (Z)	 Hammered Bronze (H)	 Clay (C)	 Rust (R)	 Green (G)	 White (W)
--	---	--	--	---	---



V110 White with Square Balusters



V110 Khaki with Square Balusters



V110 White with Square Balusters

V110 Vinyl Railing Gates & Accessories



Vinyl Railing Gates

Item Description	White	Almond	Khaki
Vinyl Railing Gate with Square Balusters 34" w x 36" h 2 - adjustable self-closing hinges & screws 1 - lockable latch	401192 \$457.08	430680 \$525.64	406187 \$548.50
Vinyl Railing Gate with Turned Balusters 34" w x 36" h 2 - adjustable self-closing hinges & screws 1 - lockable latch	401193 \$500.23	430681 \$575.26	406188 \$600.28

GATE TIP: Add 1-1/2" to the published gate width for a perfect fit.
Custom gates available.

A



Gate Accessories

Item Description	Black
A - Magna Latch Top Pull Safety Gate Latch	905100 \$138.16
B - External Access Kit Lockable push button operates latch from outside the fence.	905103 \$46.73
C - General Purpose Gate Latch Left or Right Hinge	905102 \$61.93
D - Gate Handle	905104 \$12.86
E - Gate Hinge (pair) 4" Includes 2 - heavy duty / self closing gate hinges and snap-on trim	905105P \$59.43
F - Gate Drop Rod	901040 \$128.00
G - Screw Pack for Gates	401094 \$7.45

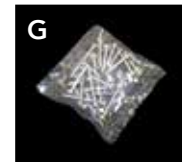

V110 Vinyl Railing Components & Accessories



Vinyl Railing Accessories

Item Description	White	Almond	Khaki
A - New England Post Cap 4"	901220 \$8.36	430206 \$10.03	904042 \$10.03
B - External Pyramid Post Cap 4"	901203 \$3.68	430203 \$4.23	406221 \$4.25
C - Classic Post Cap 4"	401048 \$11.26	430201 \$12.94	406048 \$13.51
D - New England Post Trim 4"	901225 \$7.49	430207 \$8.61	904046 \$8.99
E - Universal Post Trim (4pc.) 4" - 6-1/2"	902016 \$11.54	430221 \$13.27	902018 \$13.84
F - Vinyl Post Sleeve 4" x 4" x 38"	400345 \$16.81	430500 \$24.30	406340 \$25.36
F - Vinyl Post Sleeve 4" x 4" x 44"	400350 \$19.42	430503 \$28.06	400351 \$29.28
F - Vinyl Post Sleeve 4" x 4" x 96"	401020 \$38.80	430501 \$56.11	406020 \$58.55
F - Vinyl Post Sleeve 6" x 6" x 108"	401068 \$78.09	430502 \$112.85	401067 \$117.76
Pre-Drilled Vinyl Post Sleeves - LEVEL (For use with Vinyl Balusters & Cable Infill Only)			
G - Pre-Drilled Vinyl Post Sleeve 4" x 4" x 38" Corner (Use with 36" kits)	400345C \$21.13	N/A	N/A
G - Pre-Drilled Vinyl Post Sleeve 4" x 4" x 38" End (Use with 36" kits)	400345E \$21.13	N/A	N/A
G - Pre-Drilled Vinyl Post Sleeve 4" x 4" x 38" Line (Use with 36" kits)	400345L \$21.13	N/A	N/A
G - Pre-Drilled Vinyl Post Sleeve 4" x 4" x 44" Corner (Use with 42" kits)	400350C \$24.40	N/A	N/A
G - Pre-Drilled Vinyl Post Sleeve 4" x 4" x 44" End (Use with 42" kits)	400350E \$24.40	N/A	N/A
G - Pre-Drilled Vinyl Post Sleeve 4" x 4" x 44" Line (Use with 42" kits)	400350L \$24.40	N/A	N/A



V110 White with Square Balusters

V110 Vinyl Railing Replacement Components

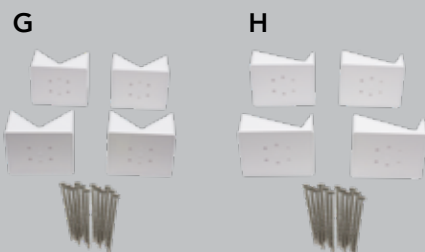
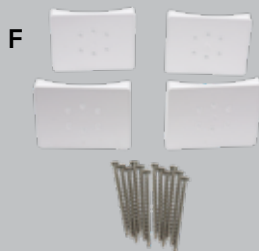
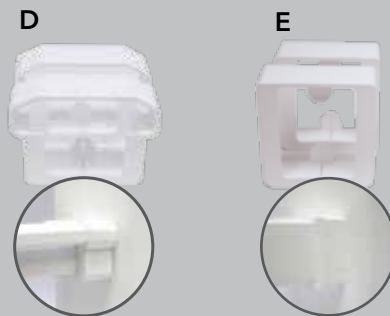
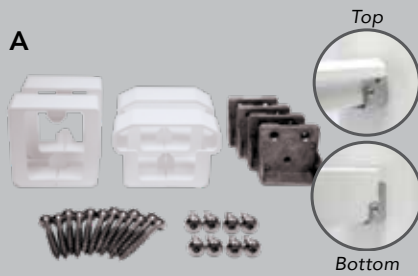

Railing Brackets & Bracket Adapters

Item Description	White	Almond	Khaki
A - Bracket Kit - Level	400610 \$34.55	430000 \$47.02	400611 \$49.07
B - Bracket Kit - Stair 28°-45°	400615 \$55.67	430001 \$75.76	400616 \$79.06
C - Vinyl Bracket Adapter Kit - Round Columns and 0°-45° Angles requires field modification	400620 \$27.26	430002 \$31.35	400621 \$32.71

Railing Trim Rings

Item Description	White	Almond	Khaki
D - Top Level Bracket Trim 1- 3/4"	904044 \$4.75	430050 \$5.23	904045 \$5.23
E -Bottom Level Bracket Trim 1-3/4" x 2-1/4"	904048 \$4.75	430051 \$4.75	904049 \$5.23

Railing Pre-Fabricated Bracket Adapters

Item Description	White	Almond	Khaki
F - Bracket Adapter Kit Round Column	400620A \$37.43	430003 \$43.04	400621A \$44.91
G - Bracket Adapter Kit 45°	400620B \$37.43	430004 \$43.04	400621B \$44.91
H - Bracket Adapter Kit 22.5°	400620C \$37.43	430005 \$43.04	400621C \$44.91

Replacement Vinyl Balusters *Not shown*

Item Description	White	Almond	Khaki
Square Baluster 1-3/8" x 1-3/8" x 32-1/2"	420300 \$7.56	435501 \$8.69	420340 \$9.07
Square Baluster 1-3/8" x 1-3/8" x 38-1/2"	420320 \$8.93	435502 \$10.27	420360 \$10.72
Turned Baluster 1-3/8" x 1-3/8" x 32-1/2"	T1303W \$11.68	435522 \$12.85	T1303C \$14.02
Turned Baluster 1-3/8" x 1-3/8" x 38-1/2"	T1304W \$13.06	435523 \$14.37	T1304C \$15.67

Replacement Aluminum Inserts

Item Description	Aluminum
Top Rail Aluminum Insert 1-3/4" x 71-3/8"	904001 \$46.83
Top Rail Aluminum Insert 1-3/4" x 95-3/8"	904002 \$62.45
Top Rail Aluminum Insert 1-3/4" x 119-3/8"	904003 \$78.05
Bottom Rail Aluminum Insert 1-3/4" x 2-1/4" x 71-3/8"	904004 \$46.83
Bottom Rail Aluminum Insert-3/4" x 2-1/4" x 95-3/8"	904005 \$62.45
Bottom Rail Aluminum Insert 1-3/4" x 2-1/4" x 119-3/8"	904006 \$78.05

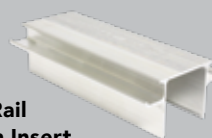

Top Rail Aluminum Insert



Bottom Rail Aluminum Insert

* FOR 5° BRACKET ADAPTER SEE PAGE 73.

V110 Vinyl Railing Replacement Components

Top Rail



Bottom Rail

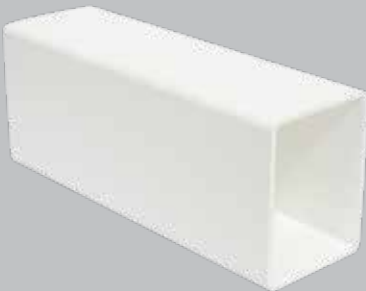

Replacement Vinyl Rails for Square or Turned Balusters ONLY

Item Description	White	Almond	Khaki
Top Rail - Level 1-3/4" x 71-3/8"	904068 \$34.17	430660 \$39.30	904069 \$41.00
Top Rail - Stair 1-3/4" x 71-3/8"	904070 \$34.17	430661 \$39.30	904071 \$41.00
Top Rail - Level 1-3/4" x 95-3/8"	904072 \$45.56	430662 \$52.39	904073 \$54.67
Top Rail - Stair 1-3/4" x 95-3/8"	904074 \$45.56	430663 \$52.28	904075 \$54.67
Top Rail - Level 1-3/4" x 119-3/8"	904076 \$56.95	430664 \$65.49	904077 \$68.33
Bottom Rail - Level 1-3/4" x 2-1/4" x 71-3/8"	904080 \$34.17	430670 \$39.30	904081 \$41.00
Bottom Rail - Stair 1-3/4" x 2-1/4" x 71-3/8"	904082 \$34.17	430671 \$39.30	904083 \$41.00
Bottom Rail - Level 1-3/4" x 2-1/4" x 95-3/8"	904084 \$45.56	430672 \$52.39	904085 \$54.67
Bottom Rail - Stair 1-3/4" x 2-1/4" x 95-3/8"	904086 \$45.56	430673 \$52.39	904087 \$54.67
Bottom Rail - Level 1-3/4" x 2-1/4" x 119-3/8"	904088 \$56.95	430674 \$65.49	904089 \$68.33

Round Aluminum Baluster Replacement Rails

Item Description	White	Almond	Khaki
Top Rail - Level 1-3/4" x 71-3/8"	904091 \$34.17	430685 \$39.30	904099 \$41.00
Top Rail - Stair 1-3/4" x 71-3/8"	904078 \$34.17	430688 \$39.30	904102 \$41.00
Top Rail - Level 1-3/4" x 95-3/8"	904095 \$45.56	430686 \$52.39	904100 \$54.67
Top Rail - Stair 1-3/4" x 95-3/8"	904096 \$45.56	430689 \$52.39	904103 \$54.67
Top Rail - Level 1-3/4" x 119-3/8"	904092 \$56.95	430687 \$65.49	904101 \$68.33
Bottom Rail - Level 1-3/4" x 2-1/4" x 71-3/8"	904097 \$34.17	430690 \$39.30	904104 \$41.00
Bottom Rail - Stair 1-3/4" x 2-1/4" x 71-3/8"	904090 \$34.17	430693 \$39.30	904107 \$41.00
Bottom Rail - Level 1-3/4" x 2-1/4" x 95-3/8"	904094 \$45.56	430691 \$52.39	904105 \$54.67
Bottom Rail - Stair 1-3/4" x 2-1/4" x 95-3/8"	904098 \$45.56	430694 \$52.39	904108 \$54.67
Bottom Rail - Level 1-3/4" x 2-1/4" x 119-3/8"	904093 \$56.95	430692 \$65.49	904106 \$68.33

Replacement Rail Support

Item Description	White	Almond	Khaki
Rail Support 4"	403048 \$5.95	430224 \$6.84	404048 \$7.14

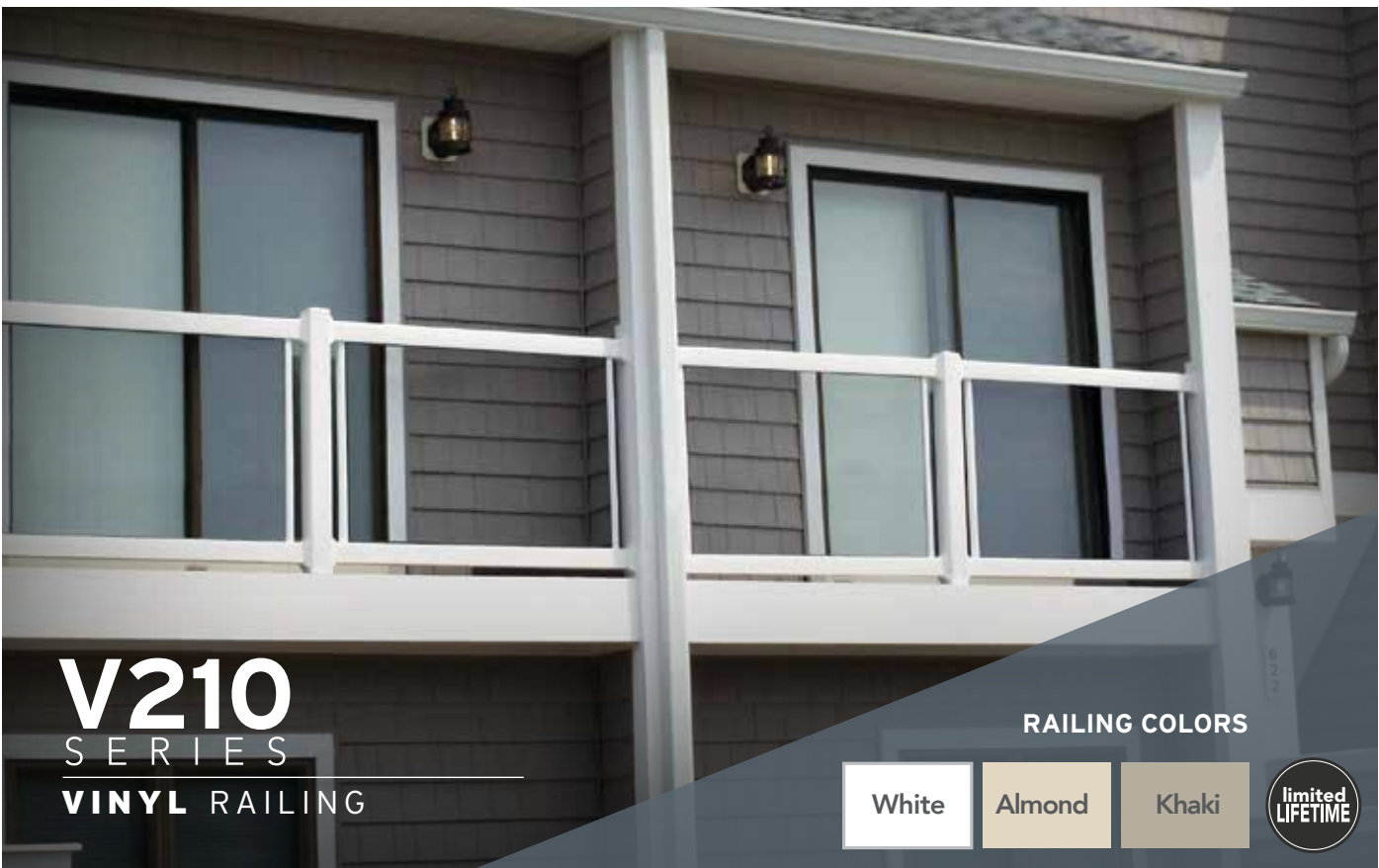

V210

SERIES

VINYL RAILING

RAILING COLORS



FEATURES & BENEFITS

- Worry-Free Maintenance With Superior Structural Integrity - Reinforced With Aluminum In Both Top & Bottom Rails
- Durable & Fade Resistant - Withstands Extreme Weather Conditions With UV Protection
- Traditional Profile - Provides Lasting Strength & Security
- Hidden Hardware Two-Piece Bracket System
- ADA Secondary Handrail Available In Matching Colors

INFILL OPTIONS



RAILING HEIGHTS

36" Residential • 42" Commercial
Meets IRC, IBC Standards

RAILING LENGTHS

6', 8', 10' Level • 6', 8' Stair
Aluminum Reinforced Top & Bottom Rail

KITS INCLUDE

Top & Bottom Rails, Balusters/Infill,
Mounting Brackets & Hardware

Limited Lifetime Warranty

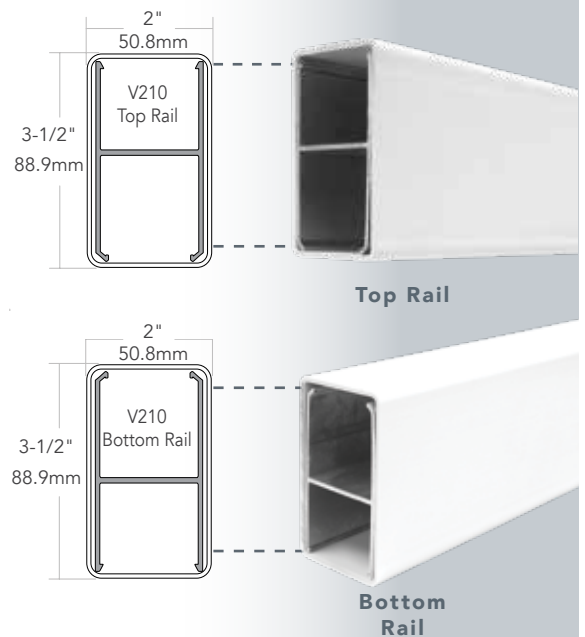

V210 Vinyl Railing Kits



KIT INCLUDES:

- Top Rail w/ Aluminum Insert
- Bottom Rail w/ Aluminum Insert
- Square Vinyl Balusters
- Mounting Brackets w/Screws

Posts, Caps and Trim Sold Separately

Square Vinyl Baluster Kits - LEVEL

Height	Length	White	Almond	Khaki
36"	6'	401000 \$175.76	430700 \$202.13	406000 \$210.91
36"	8'	401008 \$234.34	430730 \$269.49	406008 \$281.21
36"	10'	401030 \$292.93	430760 \$336.87	406030 \$351.52
42"	6'	403000 \$202.13	430710 \$232.44	406000A \$242.55
42"	8'	403008 \$269.50	430740 \$309.92	406008A \$323.40
42"	10'	403030 \$336.87	430770 \$387.40	406030A \$404.24

Square Vinyl Baluster Kits - STAIR

Height	Length	Angle	White	Almond	Khaki
36"	6'	29°-35°	401000A \$189.76	430701 \$218.23	406000B \$227.72
36"	8'	29°-35°	401016 \$248.35	430731 \$285.61	406016 \$298.03
42"	6'	29°-35°	403000A \$218.23	430711 \$250.96	406002C \$261.87
42"	8'	29°-35°	403016 \$285.60	430741 \$328.44	406016A \$342.72
36"	6'	36°-41°	401000B \$189.76	430702 \$218.23	406000C \$227.72
36"	8'	36°-41°	401009A \$248.35	430732 \$285.61	406009A \$298.03
42"	6'	36°-41°	403000B \$218.23	430712 \$250.96	406011A \$261.87
42"	8'	36°-41°	403009A \$285.60	430742 \$328.44	406011 \$342.72



V210 White with Square Balusters

V210 Vinyl Railing Kits



KIT INCLUDES:

- Top Rail w/ Aluminum Insert
- Bottom Rail w/ Aluminum Insert
- Colonial Vinyl Balusters
- Mounting Brackets w/Screws

Posts, Caps and Trim Sold Separately

Colonial Vinyl Baluster Kits - LEVEL

Height	Length	White	Almond	Khaki
36"	6'	401004 \$239.45	430703 \$275.37	406001 \$287.34
36"	8'	401012 \$319.27	430733 \$367.16	406005 \$383.13
36"	10'	401032 \$399.09	430761 \$458.96	406031 \$478.91
42"	6'	403004 \$275.37	430713 \$316.68	406001A \$330.44
42"	8'	403012 \$367.16	430743 \$422.23	406005A \$440.59
42"	10'	403032 \$458.95	430771 \$527.80	406031A \$550.75

Colonial Vinyl Baluster Kits - STAIR

Height	Length	Angle	White	Almond	Khaki
36"	6'	29°-35°	401004A \$253.87	430704 \$291.95	406001B \$304.65
36"	8'	29°-35°	401017 \$333.69	430734 \$383.75	406013 \$400.43
42"	6'	29°-35°	403004A \$291.96	430714 \$335.75	406004C \$350.35
42"	8'	29°-35°	403017 \$383.75	430744 \$441.32	406013A \$460.50
36"	6'	36°-41°	401004B \$253.87	430705 \$291.95	406001C \$304.65
36"	8'	36°-41°	401007A \$333.69	430735 \$383.75	406017 \$400.43
42"	6'	36°-41°	403004B \$291.96	430715 \$335.75	406017A \$350.35
42"	8'	36°-41°	403007A \$383.75	430745 \$441.32	406017B \$460.50



V210 White with Colonial Balusters

V210 Vinyl Railing Kits



Round Aluminum Baluster Kits - LEVEL

Height	Length	White	Almond	Khaki
36"	6'	408100(B) \$208.82	430706(B) \$240.15	408102(B) \$250.59
36"	8'	408103(B) \$278.43	430736(B) \$320.19	408105(B) \$334.12
36"	10'	408106(B) \$348.04	430762(B) \$400.24	408108(B) \$417.64
42"	6'	408115(B) \$240.15	430716(B) \$276.17	408117(B) \$288.17
42"	8'	408118(B) \$320.19	430746(B) \$368.22	408120(B) \$384.23
42"	10'	408121(B) \$400.24	430772(B) \$460.28	408123(B) \$480.29

Round Aluminum Baluster Kits - STAIR 29°- 35°

Height	Length	White	Almond	Khaki
36"	6'	408109(B) \$223.44	430707(B) \$256.96	408111(B) \$268.13
36"	8'	408112(B) \$297.92	430737(B) \$342.61	408114(B) \$357.50
42"	6'	408124(B) \$256.96	430717(B) \$295.50	408126(B) \$308.35
42"	8'	408127(B) \$342.61	430747(B) \$394.00	408129(B) \$411.13

Round Aluminum Baluster Kits ship with black balusters. To receive balusters in the color of your choice, replace (B) in item number with the color letter shown.



KIT INCLUDES:

- Top Rail w/ Aluminum Insert
- Bottom Rail w/ Aluminum Insert
- Round Aluminum Balusters
- Mounting Brackets w/Screws

Posts, Caps and Trim Sold Separately



Cable Infill Rail Kits - LEVEL

Height	Length	White	Almond	Khaki
36" & 42"	6'	201400 \$137.00	230010 \$157.54	201402 \$164.39
36" & 42"	8'	201403 \$180.57	230011 \$207.66	201405 \$216.69

Cable Infill Rail Kits - STAIR

Height	Length	White	Almond	Khaki
36" & 42"	6'	201418 \$150.01	230016 \$172.51	201420 \$180.01
36" & 42"	8'	201421 \$197.73	230017 \$227.39	201423 \$237.27

KIT INCLUDES:

- Vinyl Top Rail w/ Aluminum Insert
- Vinyl Bottom Rail w/ Aluminum Insert
- Mounting Brackets w/Screws

SEE PAGES 143 & 144 FOR ALL HORIZONTAL CABLE COMPONENTS AND ACCESSORIES NOT INCLUDED IN KIT.

Posts, Caps, Trim and Horizontal Cable Infill Sold Separately

V210 Vinyl Railing Kits



KIT INCLUDES:

- Top Rail w/ Aluminum Insert
- Bottom Rail w/ Aluminum Insert
- Acrylic Infill Panel and Stiles
- Mounting Brackets

Posts, Caps and Trim Sold Separately

Acrylic Panel Kits - LEVEL

Height	Length	White	Almond	Khaki
36"	6'	408000 \$446.87	430708 \$508.81	408008 \$536.24
36"	8'	408002 \$595.82	430738 \$678.40	408010 \$714.98
42"	6'	408012 \$513.89	430718 \$585.12	408020 \$616.66
42"	8'	408014 \$685.18	430748 \$780.16	408022 \$822.22

Acrylic Panel Field Modification Kit

Item Description	White	Almond	Khaki
Field Modification Kit 2-trim stiles, 4 - 4" spacer seals, screws and 2-neoprene pads	408030 \$56.28	430223 \$64.73	408050 \$67.54



V210 White with Acrylic Panel

V210 Vinyl Railing Gates & Accessories



Vinyl Railing Gates

Item Description	White	Almond	Khaki
Vinyl Railing Gate with Square Balusters 34"w x 36"h 2 - adjustable self-closing hinges & screws 1 - lockable latch	401190 \$468.31	431030 \$538.55	406184 \$561.97
Vinyl Railing Gate with Colonial Balusters 34"w x 36"h 2 - adjustable self-closing hinges & screws 1 - lockable latch	401191 \$497.59	431031 \$572.23	406186 \$597.10

GATE TIP: Add 1-1/2" to the published gate width for a perfect fit.
Custom gates available.

A



Top Pull Model

Gate Accessories

Item Description	Black
A - Magna Latch Top Pull Safety Gate Latch	905100 \$138.16
B - External Access Kit Lockable push button operates latch from outside the fence.	905103 \$46.73
C - General Purpose Gate Latch Left or Right Hinge	905102 \$61.93
D - Gate Handle	905104 \$12.86
E - Gate Hinge (pair) 4" Includes 2 - heavy duty / self closing gate hinges and snap-on trim	905105P \$59.43
F - Gate Drop Rod	901040 \$128.00
G - Screw Pack for Gates	401094 \$7.45

B



C



D



LIMITED LIFETIME WARRANTY
NO RUST
NO STAIN

E

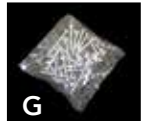



G



F

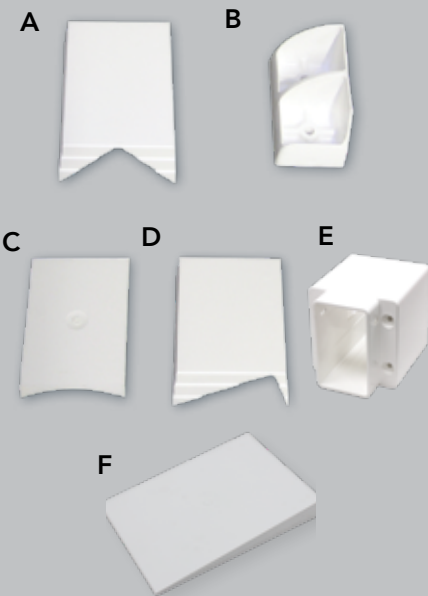

V210 Vinyl Railing Brackets and Adapters

		Railing Adapters			
		Item Description	White	Almond	Khaki
A - 45° Rail Bracket Adapter Screws Included		401079 \$12.05	430108 \$13.85	406079 \$14.45	
B - 22-1/2° 45° Internal Bracket - Hidden Bracket		900361 \$10.83	N/A	N/A	
C - Round Column Adapter (6"-10")		401181 \$14.66	430214 \$16.86	406181 \$17.60	
D - Rail Bracket Adapter 22-1/2° V210/V220 Screws Included		401078 \$12.05	430111 \$13.85	406078 \$14.45	
E - Rail Angle Bracket		900247 \$16.29	430112 \$18.73	406051 \$19.55	
F - 5° Bracket Adapter for ADA Accessibility Ramps		900200 \$14.66	430208 \$16.86	900204 \$17.60	

		Vinyl Railing Brackets			
		Item Description	White	Almond	Khaki
G - Top/Bottom Rail Bracket - Level 1 Bracket		401080 \$9.66	430150 \$11.10	406080 \$11.59	
H - Top/Bottom Rail Bracket - Stair 1 Bracket		401081 \$10.84	430151 \$12.47	406081 \$13.01	
I - Top and Bottom Rail Bracket Kit - Level 4 Brackets + Screws		900345 \$46.42	430100 \$53.38	406085 \$55.70	
J - Top and Bottom Rail Bracket Kit - Stair 4 Brackets + Screws		900349 \$46.42	430101 \$53.38	406086 \$55.70	

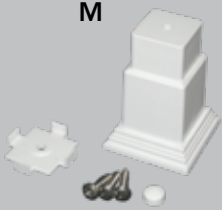
		Mount Master			
		Item Description	White	Almond	Khaki
K - Mount Master		107300 \$16.72	N/A	N/A	
		Rail Wall Mount			
		Item Description	White	Almond	Khaki
L - Rail Wall Mount 2" x 3-1/2"		901209 \$3.49	N/A	905644 \$4.18	
		Rail Support			
		Item Description	White	Almond	Khaki
M - Rail Support		401047-1 \$11.93	430225 \$13.72	406047-1 \$14.31	

V210 Vinyl Railing Replacement Components



Top & Bottom Rail



Aluminum Insert

Replacement Rails for Round Aluminum Baluster • Top & Bottom - LEVEL

Item Description & Length	White	Almond	Khaki
Top Rail - Level 1-3/4" x 6'	401102 \$41.47	430820 \$47.69	406130 \$49.76
Top Rail - Level 1-3/4" x 8'	401146 \$55.30	430821 \$63.59	406131 \$66.35
Top Rail - Level 1-3/4" x 10'	401161 \$69.13	430822 \$79.49	406132 \$82.95

Replacement Rails for Round Aluminum Baluster • Top & Bottom - STAIR

Item Description & Length	White	Almond	Khaki
Top Rail - Stair 1-3/4" x 6'	401103 \$41.47	430823 \$47.69	406133 \$49.76
Top Rail - Stair 1-3/4" x 8'	401122 \$55.30	430824 \$63.59	406134 \$66.36
Top Rail - Level 1-3/4" x 10'	401161 \$69.13	430822 \$79.49	406132 \$82.95

Replacement Aluminum Inserts

Item Description	Length	Item
Top / Bottom Rail Aluminum Insert	6'	401041A \$73.68
Top / Bottom Rail Aluminum Insert	8'	401043A \$98.24
Top / Bottom Rail Aluminum Insert	10'	401045A \$122.81

Replacement Screw Packs *Not Shown*

Bracket Screw Pack - Level & Stair	401088 \$7.06
------------------------------------	------------------

Replacement Rails for Square Balusters • Top & Bottom - LEVEL

Length	White	Almond	Khaki
6'	401100 \$41.47	430800 \$47.69	406100 \$49.76
8'	401140 \$55.30	430806 \$63.59	406120 \$66.36
10'	401160 \$69.13	430812 \$79.49	406150 \$82.95

Replacement Rails for Square Balusters • Top & Bottom - STAIR

Length	Angle	White	Almond	Khaki
6'	29°-35°	401100A \$41.47	430801 \$47.69	406108 \$49.76
6'	36°-41°	401101 \$41.47	430802 \$47.69	406109 \$49.76
8'	29°-35°	401120 \$55.30	430807 \$63.59	406140 \$66.35
8'	36°-41°	401121 \$55.30	430808 \$63.59	406142 \$66.35

Replacement Rails for Colonial Balusters • Top & Bottom - LEVEL

Length	White	Almond	Khaki
6'	401105 \$41.47	430803 \$47.69	406101 \$49.76
8'	401145 \$55.30	430809 \$63.59	406121 \$66.36
10'	401165 \$69.13	430813 \$79.49	406151 \$82.95

Replacement Rails for Colonial Balusters • Top & Bottom - STAIR

Length	Angle	White	Almond	Khaki
6'	29°-35°	401106 \$41.47	430804 \$47.69	406110 \$49.76
6'	36°-41°	401107 \$41.47	430805 \$47.69	406111 \$49.76
8'	29°-35°	401125 \$55.30	430810 \$63.59	406141 \$66.35
8'	36°-41°	401126 \$55.30	430811 \$63.59	406143 \$66.35

Replacement Vinyl Balusters *Not Shown*

Item Description	White	Almond	Khaki
Square Baluster for 36" Railing 1-3/8" x 1-3/8" x 31-3/4"	900333 \$8.29	435500 \$9.53	905611 \$9.94
Square Baluster for 42" Railing 1-3/8" x 1-3/8" x 38-1/2"	420320 \$8.93	435502 \$10.27	905612 \$10.72
Colonial Baluster for 36" Railing 1-1/4" x 1-1/4" x 32"	900133 \$12.81	435520 \$14.73	905630 \$15.37
Colonial Baluster for 42" Railing 1-1/4" x 1-1/4" x 38-1/4"	900135 \$14.32	435521 \$16.47	905631 \$17.19

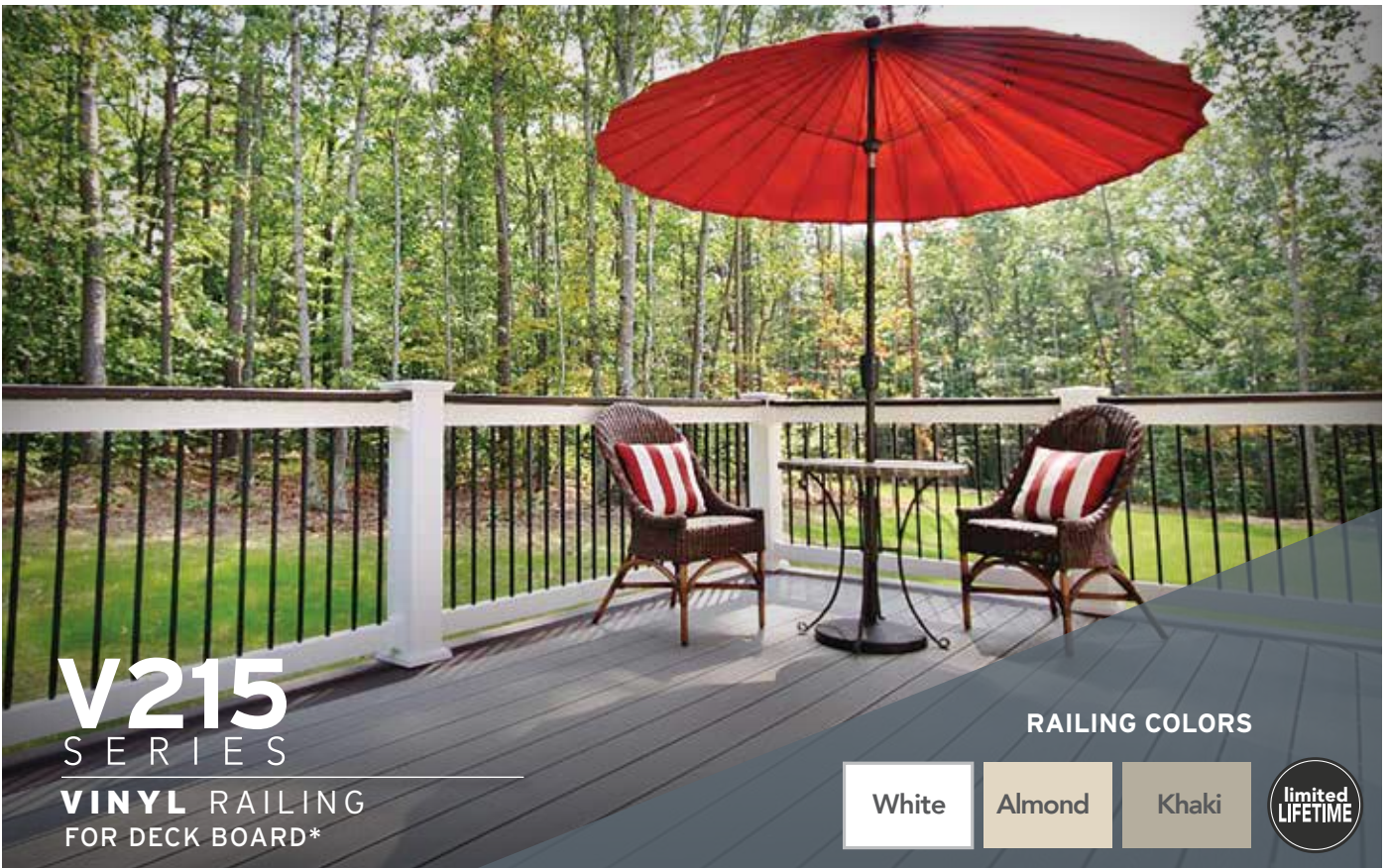

V215 SERIES

VINYL RAILING
FOR DECK BOARD*

RAILING COLORS

White Almond Khaki 

FEATURES & BENEFITS

- Worry-Free Maintenance With Superior Structural Integrity - Reinforced With Aluminum In Both Top & Bottom Rails
- Durable & Fade Resistant - Withstands Extreme Weather Conditions With UV Protection
- Versatile Railing System - Choose from Post-To-Post, Over-The-Post Installation Methods
- Traditional Profile - Provides Lasting Strength & Security
- Hidden Hardware Two-Piece Bracket System
- ADA Secondary Handrail Available In Matching Colors
- Coordinate Your Design By Installing Your Preferred Deck Board As A Cap Rail

INFILL OPTIONS

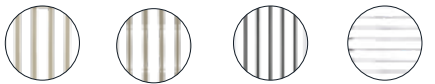

Square Vinyl Colonial Vinyl Round Aluminum Horizontal Cable

RAILING HEIGHTS

36" Residential • 42" Commercial
Meets IRC, IBC Standards

RAILING LENGTHS

6', 8', 10' Level • 6', 8' Stair

Aluminum Reinforced Top & Bottom Rail

KITS INCLUDE*

Top & Bottom Rails, Balusters/Infill,
Mounting Brackets & Hardware

**Deck Board Not Included In Kits*

Limited Lifetime Warranty

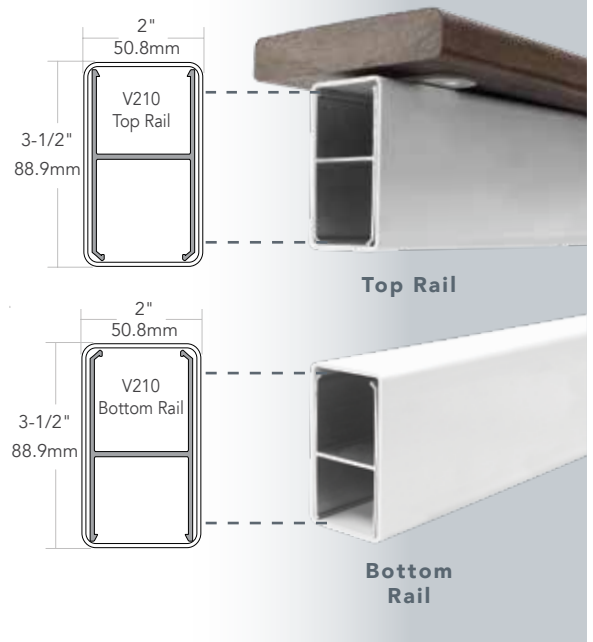

V215 Vinyl Railing Kits For Deck Board* Cap Rail



Square Vinyl Baluster Kits* - LEVEL

Height	Length	White	Almond	Khaki
36"	6'	401400 \$177.47	430850 \$204.10	401428 \$212.96
36"	8'	401401 \$236.62	430870 \$272.11	401429 \$283.94
36"	10'	401402 \$295.77	430890 \$340.15	401430 \$354.93
42"	6'	401442 \$204.09	430860 \$234.70	401470 \$244.91
42"	8'	401443 \$272.12	430880 \$312.93	401471 \$326.53
42"	10'	401444 \$340.13	430895 \$391.16	401472 \$408.16

KIT INCLUDES*:

- Top Rail w/ Aluminum Insert
- Bottom Rail w Aluminum Insert
- Square Vinyl Balusters
- Mounting Brackets w/Screws
- Deck Board Mounting Plates w/Screws

*Deck Board Not Included

Post, Caps and Trim Sold Separately

Square Vinyl Baluster Kits* - STAIR 29°- 35°

Height	Length	White	Almond	Khaki
36"	6'	401403 \$191.61	430851 \$220.35	401431 \$229.93
36"	8'	401405 \$250.76	430871 \$288.38	401433 \$300.92
42"	6'	401445 \$220.35	430861 \$253.40	401473 \$264.42
42"	8'	401447 \$288.38	430881 \$331.62	401475 \$346.04



Colonial Vinyl Baluster Kits* - LEVEL

Height	Length	White	Almond	Khaki
36"	6'	401407 \$241.78	430853 \$278.04	401435 \$290.14
36"	8'	401408 \$322.37	430873 \$370.73	401436 \$386.84
36"	10'	401409 \$402.97	430891 \$463.41	401437 \$483.56
42"	6'	401449 \$278.04	430863 \$319.75	401477 \$333.65
42"	8'	401450 \$370.72	430883 \$426.32	401478 \$444.87
42"	10'	401451 \$463.41	430896 \$532.92	401479 \$556.10

KIT INCLUDES*:

- Top Rail w/ Aluminum Insert
- Bottom Rail w/ Aluminum Insert
- Colonial Vinyl Balusters
- Mounting Brackets w/Screws
- Deck Board Mounting Plates w/Screws

*Deck Board Not Included

Post, Caps and Trim Sold Separately

Colonial Vinyl Baluster Kits* - STAIR 29°- 35°

Height	Length	White	Almond	Khaki
36"	6'	401410 \$256.33	430854 \$294.79	401438 \$307.61
36"	8'	401412 \$336.93	430874 \$387.47	401440 \$404.32
42"	6'	401452 \$294.79	430864 \$339.01	401480 \$353.74
42"	8'	401454 \$387.48	430884 \$445.60	401482 \$464.98

V215 Vinyl Railing Kits For Deck Board* Cap Rail



KIT INCLUDES*:

- Top Rail w/ Aluminum Insert
- Bottom Rail w/ Aluminum Insert
- Round Aluminum Balusters
- Mounting Brackets w/Screws
- Deck Board Mounting Plates w/Screws

*Deck Board Not Included

Post, Caps and Trim Sold Separately

**Assuming 2" bottom rail sweep height the 36" and 42" kits will provide a 35" and 39" finished rail height.

Round Aluminum Baluster Kits* - LEVEL

Height	Length	White	Almond	Khaki
36"	6'	401484(B) \$208.82	430856(B) \$240.14	401386(B) \$250.59
36"	8'	401485(B) \$278.43	430876(B) \$320.19	401387(B) \$334.11
36"	10'	401486(B) \$348.03	430892(B) \$400.24	401388(B) \$417.65
42"	6'	401491(B) \$240.15	430866(B) \$276.17	401393(B) \$288.18
42"	8'	401492(B) \$320.19	430886(B) \$368.22	401394(B) \$384.24
42"	10'	401493(B) \$400.24	430897(B) \$460.28	401395(B) \$480.29

Round Aluminum Baluster Kits* - STAIR 29°- 35°

Height	Length	White	Almond	Khaki
36"***	6'	401487(B) \$223.44	430857(B) \$256.96	401389(B) \$268.13
36"***	8'	401489(B) \$297.92	430877(B) \$342.61	401391(B) \$357.50
42"	6'	401494(B) \$256.95	430867(B) \$295.50	401396(B) \$308.34
42"	8'	401496(B) \$342.61	430887(B) \$394.00	401398(B) \$411.13

Round Aluminum Baluster Kits ship with black balusters. To receive balusters in the color of your choice, replace (B) in item number with the color letter shown.



KIT INCLUDES*:

- Vinyl Top Rail w/ Aluminum Insert
- Vinyl Bottom Rail w/ Aluminum Insert
- Mounting Brackets w/Screws
- Deck Board Mounting Plates w/Screws

*Deck Board Not Included

Posts, Caps, Trim and Horizontal Cable Infill Sold Separately

Cable Infill Rail Kits* - LEVEL

Height	Length	White	Almond	Khaki
36" & 42"	6'	201412 \$137.00	230014 \$157.54	201414 \$164.39
36" & 42"	8'	201415 \$180.57	230015 \$207.66	201417 \$216.69

Cable Infill Rail Kits* - STAIR

Height	Length	White	Almond	Khaki
36" & 42"	6'	201430 \$150.01	230020 \$172.51	201432 \$180.01
36" & 42"	8'	201433 \$197.73	230021 \$227.39	201435 \$237.27

SEE PAGES 143 & 144 FOR ALL HORIZONTAL CABLE COMPONENTS AND ACCESSORIES NOT INCLUDED IN KIT.

V215 Vinyl Railing Gates & Accessories



(Same Gate as V210)

GATE TIP: Add 1-1/2" to the published gate width for a perfect fit. Custom gates available.

Vinyl Railing Gates

Item Description	White	Almond	Khaki
Vinyl Railing Gate with Square Balusters 34"w x 36"h 2 - adjustable self-closing hinges & screws 1 - lockable latch (Deckboard and mounting plate sold separately)	401190 \$468.31	431030 \$538.55	406184 \$561.97
Vinyl Railing Gate with Colonial Balusters 34"w x 36"h 2 - adjustable self-closing hinges & screws 1 - lockable latch (Deckboard and mounting plate sold separately)	401191 \$497.59	431031 \$572.23	406186 \$597.10

Deckboard Gate Accessories

Item Description	Black
Deckboard Mounting Plate Bracket	900404 \$1.27
Screw Pack for Deckboard Mounting Plate Bracket	900405 \$4.35

A Top Pull Model



B



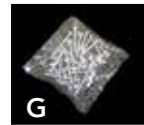

Gate Accessories

Item Description	Black
A - Magna Latch Top Pull Safety Gate Latch	905100 \$138.16
B - External Access Kit Lockable push button operates latch from outside the fence.	905103 \$46.73
C - General Purpose Gate Latch Left or Right Hinge	905102 \$61.93
D - Gate Handle	905104 \$12.86
E - Gate Hinge (pair) 4" Includes 2 - heavy duty / self closing gate hinges and snap-on trim	905105P \$59.43
F - Gate Drop Rod	901040 \$128.00
G - Screw Pack for Gates	401094 \$7.45

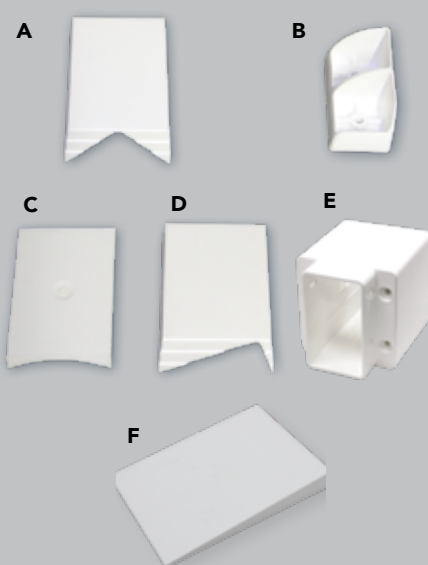

V215 Vinyl Railing Brackets and Adapters

Railing Adapters <i>(Field modification of deckboard is needed for proper fit)</i>				
Item Description		White	Almond	Khaki
	A - 45° Rail Bracket Adapter Screws Included	401079 \$12.05	430108 \$13.85	406079 \$14.45
	B - 22-1/2° 45° Internal Bracket - Hidden Bracket	900361 \$10.83	N/A	N/A
	C - Round Column Adapter (6"-10")	401181 \$14.66	430214 \$16.86	406181 \$17.60
	D - Rail Bracket Adapter 22-1/2° V210/V215/V220 Screws Included	401078 \$12.05	430111 \$13.85	406078 \$14.45
	E - Rail Angle Bracket	900247 \$16.29	430112 \$18.73	406051 \$19.55
	F - 5° Bracket Adapter for ADA Accessibility Ramps	900200 \$14.66	430208 \$16.86	900204 \$17.60

Vinyl Railing Brackets				
Item Description		White	Almond	Khaki
	G - V215 Mounting Bracket Kit - Level (2) deck board cap rail brackets - level, (2) V210 railing brackets - level, (4) mounting plates and hardware	900391 \$46.42	430102 \$53.38	900391K \$55.70
	H - V215 Mounting Bracket Kit - Stair (2) deck board cap rail brackets - stair, (2) V210 railing brackets - stair, (4) mounting plates and hardware	900392 \$46.42	430103 \$53.38	900392K \$55.70

Mount Master					
Item Description		White	Almond	Khaki	
	I - Mount Master	107300 \$16.72	N/A	N/A	
	Rail Wall Mount				
	Item Description		White	Almond	Khaki
J - Rail Wall Mount 2" x 3-1/2"		901209 \$3.49	N/A	905644 \$4.18	
Rail Support					
Item Description		White	Almond	Khaki	
K - Rail Support		401047-1 \$11.93	430225 \$13.72	406047-1 \$14.31	

V215 Vinyl Railing Replacement Components



Top & Bottom Rail



Aluminum Insert

Replacement Rails for Square Balusters • Top & Bottom - LEVEL

Length	White	Almond	Khaki
6'	401100 \$41.47	430800 \$47.69	406100 \$49.76
8'	401140 \$55.30	430806 \$63.59	406120 \$66.36
10'	401160 \$69.13	430812 \$79.49	406150 \$82.95

Replacement Rails for Square Balusters • Top & Bottom - STAIR

Length	Angle	White	Almond	Khaki
6'	29°-35°	401100A \$41.47	430801 \$47.69	406108 \$49.76
6'	36°-41°	401101 \$41.47	430802 \$47.69	406109 \$49.76
8'	29°-35°	401120 \$55.30	430807 \$63.59	406140 \$66.35
8'	36°-41°	401121 \$55.30	430808 \$63.59	406142 \$66.35

Replacement Rails for Colonial Balusters • Top & Bottom - LEVEL

Length	White	Almond	Khaki
6'	401105 \$41.47	430803 \$47.69	406101 \$49.76
8'	401145 \$55.30	430809 \$63.59	406121 \$66.36
10'	401165 \$69.13	430813 \$79.49	406151 \$82.95

Replacement Rails for Colonial Balusters • Top and Bottom - STAIR

Length	Angle	White	Almond	Khaki
6'	29°-35°	401106 \$41.47	430804 \$47.69	406110 \$49.76
6'	36°-41°	401107 \$41.47	430805 \$47.69	406111 \$49.76
8'	29°-35°	401125 \$55.30	430810 \$63.59	406141 \$66.35
8'	36°-41°	401126 \$55.30	430811 \$63.59	406143 \$66.35

Replacement Aluminum Inserts

Item Description	Length	Item
Top / Bottom Rail Aluminum Insert	6'	401041A \$73.68
Top / Bottom Rail Aluminum Insert	8'	401043A \$98.24
Top / Bottom Rail Aluminum Insert	10'	401045A \$122.81

Replacement Screw Packs *Not Shown*

Bracket Screw Pack - Level & Stair	401088 \$7.06
------------------------------------	------------------

Replacement Vinyl Balusters *Not Shown*

Item Description	White	Almond	Khaki
Square Baluster for 36" Railing 1-3/8" x 1-3/8" x 31-3/4"	900333 \$8.29	435500 \$9.53	905611 \$9.94
Square Baluster for 42" Railing 1-3/8" x 1-3/8" x 38-1/2"	420320 \$8.93	435502 \$10.27	905612 \$10.72
Colonial Baluster for 36" Railing 1-1/4" x 1-1/4" x 32"	900133 \$12.81	435520 \$14.73	905630 \$15.37
Colonial Baluster for 42" Railing 1-1/4" x 1-1/4" x 38-1/4"	900135 \$14.32	435521 \$16.47	905631 \$17.19

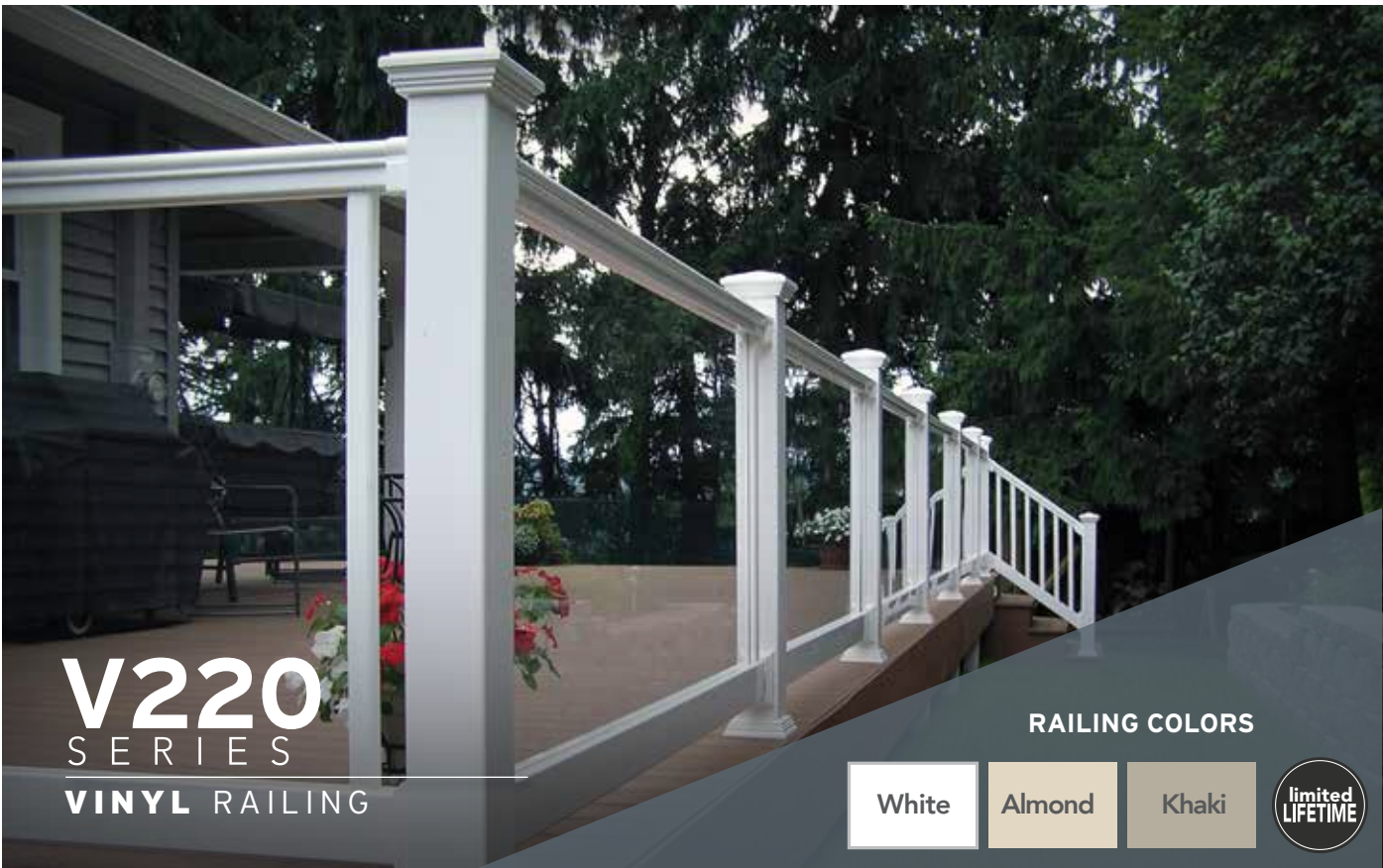

V220
SERIES
VINYL RAILING

RAILING COLORS







White Almond Khaki



FEATURES & BENEFITS

- Traditional Profile - Provides Lasting Strength & Security
- Durable & Fade Resistant - Withstands Extreme Weather Conditions With UV Protection
- Hidden Hardware Two-Piece Bracket System
- Worry-Free Maintenance With Superior Structural Integrity - Reinforced With Aluminum In Both Top & Bottom Rails
- ADA Secondary Handrail Available In Matching Colors

INFILL OPTIONS

 Square Vinyl
  Colonial Vinyl
  Round Aluminum
  Acrylic Panel
  3-Rail
  Horizontal Cable

RAILING HEIGHTS

36" Residential • 42" Commercial
Meets IRC, IBC Standards

RAILING LENGTHS

6', 8', 10' Level • 6', 8' Stair
Aluminum Reinforced Top & Bottom Rail

KITS INCLUDE

Top & Bottom Rails, Balusters/Infill,
Mounting Brackets & Hardware

Limited Lifetime Warranty

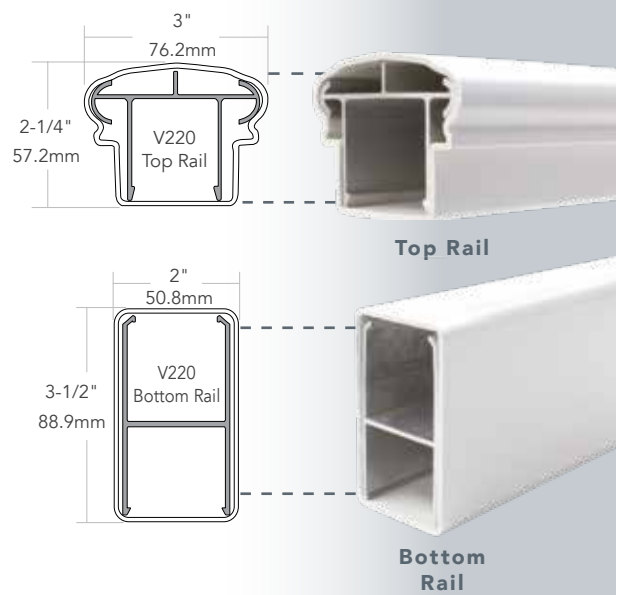

V220 Vinyl Railing Kits



KIT INCLUDES:

- Top Rail w/ Aluminum Insert
- Bottom Rail w/ Aluminum Insert
- Square Vinyl Balusters
- Mounting Brackets w/Screws

Post, Caps and Trim Sold Separately

Square Vinyl Baluster Kits - LEVEL

Height	Length	White	Almond	Khaki
36"	6'	401003 \$175.76	430900 \$202.13	406002 \$210.91
36"	8'	401015 \$234.34	430930 \$269.49	406006 \$281.21
36"	10'	401031 \$292.93	430960 \$336.87	406032 \$351.52
42"	6'	403003 \$202.13	430910 \$232.44	406002A \$242.55
42"	8'	403015 \$269.50	430940 \$309.92	406006A \$323.40
42"	10'	403031 \$336.87	430965 \$387.40	406032A \$404.24

Square Vinyl Baluster Kits - STAIR

Height	Length	Angle	White	Almond	Khaki
36"	6'	29°-35°	401003A \$196.77	430901 \$226.28	406004 \$236.12
36"	8'	29°-35°	401011 \$255.35	430931 \$293.65	406014 \$306.42
42"	6'	29°-35°	403003A \$226.29	430911 \$260.23	406002B \$271.54
42"	8'	29°-35°	403011 \$293.66	430941 \$337.70	406014A \$352.39
36"	6'	36°-41°	401003B \$196.77	430902 \$226.28	406004A \$236.12
36"	8'	36°-41°	401009 \$255.35	430932 \$293.65	406009 \$306.42
42"	6'	36°-41°	403003B \$226.29	430912 \$260.23	406012A \$271.54
42"	8'	36°-41°	403009 \$293.66	430942 \$337.70	406012 \$352.39



V220 White with Square Balusters

V220 Vinyl Railing Kits



KIT INCLUDES:

- Top Rail w/ Aluminum Insert
- Bottom Rail w/ Aluminum Insert
- Colonial Vinyl Balusters
- Mounting Brackets w/Screws

Post, Caps and Trim Sold Separately

Colonial Vinyl Baluster Kits - LEVEL

Height	Length	White	Almond	Khaki
36"	6'	401006 \$239.45	430903 \$275.37	406003 \$287.34
36"	8'	401014 \$319.27	430933 \$367.16	406007 \$383.13
36"	10'	401033 \$399.09	430961 \$458.96	406033 \$478.91
42"	6'	403006 \$275.37	430913 \$316.68	406003A \$330.44
42"	8'	403014 \$367.16	430943 \$422.23	406007A \$440.59
42"	10'	403033 \$458.95	430966 \$527.80	406033A \$550.75

Colonial Vinyl Baluster Kits - STAIR

Height	Length	Angle	White	Almond	Khaki
36"	6'	29°-35°	401006A \$261.09	430904 \$300.25	406003B \$313.31
36"	8'	29°-35°	401019 \$340.91	430934 \$392.05	406015 \$409.09
42"	6'	29°-35°	403006A \$300.25	430914 \$345.29	406004B \$360.31
42"	8'	29°-35°	403019 \$392.04	430944 \$450.85	406015A \$470.45
36"	6'	36°-41°	401006B \$261.09	430905 \$300.25	406003C \$313.31
36"	8'	36°-41°	401007 \$340.91	430935 \$392.05	406019 \$409.09
42"	6'	36°-41°	403006B \$300.25	430915 \$345.29	406019A \$360.31
42"	8'	36°-41°	403007 \$392.04	430945 \$450.85	406019B \$470.45



V220 White ADA with Colonial Balusters

V220 Vinyl Railing Kits



KIT INCLUDES:

- Top Rail w/ Aluminum Insert
- Bottom Rail w/ Aluminum Insert
- Round Aluminum Balusters
- Mounting Brackets w/Screws

Post, Caps and Trim Sold Separately

Round Aluminum Baluster Kits - LEVEL

Height	Length	White	Almond	Khaki
36"	6'	408130(B) \$208.82	430906(B) \$240.15	408132(B) \$250.59
36"	8'	408133(B) \$278.43	430936(B) \$320.19	408135(B) \$334.12
36"	10'	408136(B) \$348.04	430962(B) \$400.24	408138(B) \$417.64
42"	6'	408145(B) \$240.15	430916(B) \$276.17	408147(B) \$288.17
42"	8'	408148(B) \$320.19	430946(B) \$368.22	408150(B) \$384.23
42"	10'	408151(B) \$400.24	430967(B) \$460.28	408153(B) \$480.29

Round Aluminum Baluster Kits - STAIR 29°- 35°

Height	Length	White	Almond	Khaki
36"	6'	408139(B) \$223.44	430907(B) \$256.96	408141(B) \$268.13
36"	8'	408142(B) \$297.92	430947(B) \$394.00	408144(B) \$357.50
42"	6'	408154(B) \$256.96	430917(B) \$295.50	408156(B) \$308.35
42"	8'	408157(B) \$342.61	430937(B) \$342.61	408159(B) \$411.13

Round Aluminum Baluster Kits ship with black balusters. To receive balusters in the color of your choice, replace (B) in item number with the color letter shown.

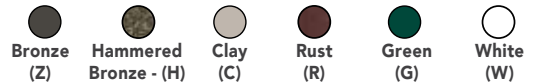

KIT INCLUDES:

- Vinyl Top Rail w/ Aluminum Insert
- Vinyl Bottom Rail w/ Aluminum Insert
- Mounting Brackets w/Screws

Posts, Caps, Trim and Horizontal Cable Infill Sold Separately

Cable Infill Rail Kits - LEVEL

Height	Length	White	Almond	Khaki
36" & 42"	6'	201406 \$137.55	230012 \$158.18	201408 \$165.06
36" & 42"	8'	201409 \$184.60	230013 \$212.29	201411 \$221.52

Cable Infill Rail Kits - STAIR

Height	Length	White	Almond	Khaki
36" & 42"	6'	201424 \$150.61	230018 \$173.21	201426 \$180.74
36" & 42"	8'	201427 \$202.13	230019 \$232.45	201429 \$242.56

SEE PAGES 143 & 144 FOR ALL HORIZONTAL CABLE COMPONENTS AND ACCESSORIES NOT INCLUDED IN KIT.

V220 Vinyl Railing Kits



KIT INCLUDES:

- Top Rail w/ Aluminum Insert
- Bottom Rail w/ Aluminum Insert
- Acrylic Infill Panel and Stiles
- Mounting Brackets

Post, Caps and Trim Sold Separately

Acrylic Panel Kits - LEVEL

Height	Length	White	Almond	Khaki
36"	6'	408001 \$446.87	430908 \$508.81	408009 \$536.24
36"	8'	408003 \$595.82	430938 \$678.40	408011 \$714.98
42"	6'	408013 \$513.89	430918 \$585.12	408021 \$616.66
42"	8'	408015 \$685.18	430948 \$780.16	408023 \$822.22

Acrylic Panel Field Modification Kit

Item Description	White	Almond	Khaki
Field Modification Kit 2-trim stiles, 4 - 4" spacer seals, screws and 2-neoprene pads	408030 \$56.28	408040 \$64.73	408050 \$67.54



V220 White with Acrylic Panels



KIT INCLUDES:

- Top Rail w/ Aluminum Insert
- Mid-Rail
- Bottom Rail w/ Aluminum Insert
- Square Vinyl Balusters
- Mounting Brackets

Post, Caps and Trim Sold Separately

3-Rail Infill Kits - LEVEL

Height	Length	White	Khaki
42"	6'	401602 \$210.91	401612 \$253.10
42"	8'	401606 \$281.21	401616 \$337.45
42"	10'	401609 \$351.52	401619 \$421.82

3-Rail Infill Kits - STAIR 29°- 35°

Height	Length	White	Khaki
42"	6'	401603 \$236.11	401613 \$283.34
42"	8'	401607 \$306.42	401617 \$367.70



V220 White with 3-Rail Square Balusters

V220 Vinyl Railing Gates & Accessories

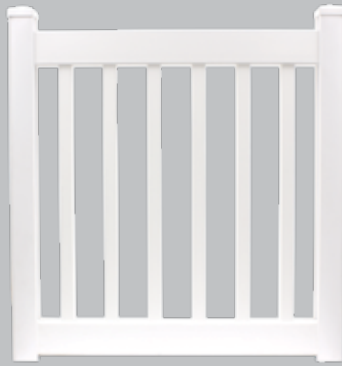

(Same Gate as V210)

Vinyl Railing Gates

Item Description	White	Almond	Khaki
Vinyl Railing Gate with Square Top Rail & Square Balusters 34" w x 36" h 2 - adjustable self-closing hinges & screws 1 - lockable latch	401190 \$468.31	431030 \$538.55	406184 \$561.97
Vinyl Railing Gate with Square Top Rail & Colonial Balusters 34" w x 36" h 2 - adjustable self-closing hinges & screws 1 - lockable latch	401191 \$497.59	431031 \$572.23	406186 \$597.10

GATE TIP: Add 1-1/2" to the published gate width for a perfect fit.
Custom gates available.

A



Top Pull Model

Gate Accessories

Item Description	Black
A - Magna Latch Top Pull Safety Gate Latch	905100 \$138.16
B - External Access Kit Lockable push button operates latch from outside the fence.	905103 \$46.73
C - General Purpose Gate Latch Left or Right Hinge	905102 \$61.93
D - Gate Handle	905104 \$12.86
E - Gate Hinge (pair) 4" Includes 2 - heavy duty / self closing gate hinges and snap-on trim	905105P \$59.43
F - Gate Drop Rod	901040 \$128.00
G - Screw Pack for Gates	401094 \$7.45



E

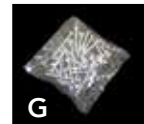

G

F



V220 Vinyl Railing Brackets and Adapters

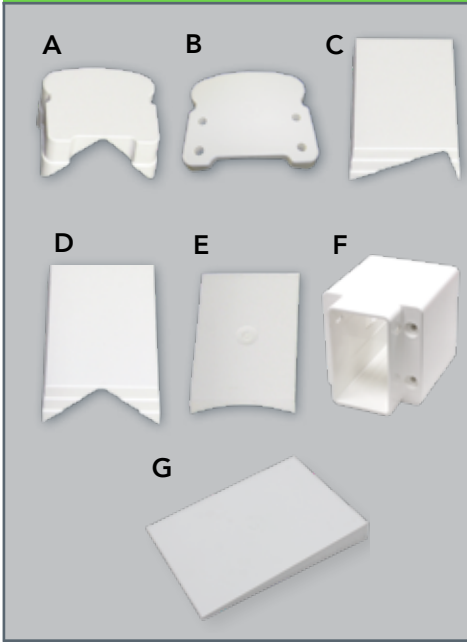

Railing Adapters

Item Description	White	Almond	Khaki
A - 45° Rail Bracket Adapter Screws Included	401077 \$12.05	430109 \$13.85	406077 \$14.45
B - Round Column Bracket Adapter (6"-10")	401082 \$14.66	430110 \$16.86	406182 \$17.60
C - Rail Bracket Adapter 22-1/2° V210/V215/V220 Screws Included	401078 \$12.05	430111 \$13.85	406078 \$14.45
D - 45° Rail Bracket Adapter Screws Included (Bottom Rail Only)	401079 \$12.05	430108 \$13.85	406079 \$14.45
E - Round Column Adapter (6"-10") (Bottom Rail Only)	401181 \$14.66	430214 \$16.86	406181 \$17.60
F - Rail Angle Bracket	900247 \$16.29	430112 \$18.73	406051 \$19.55
G - 5° Bracket Adapter for ADA Accessibility Ramps	900200 \$14.66	430208 \$16.86	900204 \$17.60

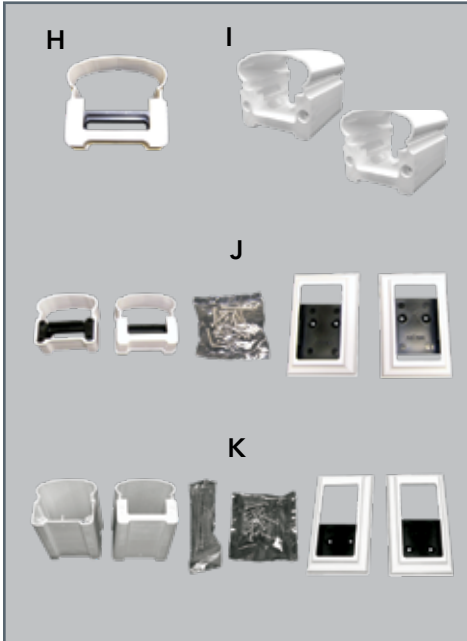

Vinyl Railing Brackets

Item Description	White	Almond	Khaki
H - Mounting Bracket - level 1 Bracket	900386 \$10.04	430152 \$11.55	406202 \$12.05
I - Mounting Brackets - stair 2 brackets, pins, screws + screw caps	900387 \$26.29	430153 \$30.23	406203 \$31.55
J - Mounting Bracket Kit - level 4 brackets + screws	900385 \$46.42	430104 \$53.38	406087 \$55.70
K - Mounting Bracket Kit - stair 4 brackets + screws	900390 \$49.51	430105 \$56.94	406088 \$59.41

3-Rail Brackets • Not Shown

Item Description	White	Khaki
3-rail • Mid-Rail Bracket Kit - Level • (2) Mid-Rail Brackets & Screw Pack *requires purchase of top and bottom railing bracket packs	401630 \$20.43	401632 \$24.52
3-rail • Mid-Rail Bracket Kit - Stair • (2) Mid-Rail Brackets & Screw Pack *requires purchase of top and bottom railing bracket packs	401631 \$32.93	401633 \$39.52



Mount Master

Item Description	White	Almond	Khaki
L - Mount Master	107300 \$16.72	N/A	N/A

Rail Wall Mount

Item Description	White	Almond	Khaki
M - Rail Wall Mount 2" x 3-1/2"	901209 \$3.49	N/A	905644 \$4.18

Rail Support

Item Description	White	Almond	Khaki
N - Rail Support	401047-1 \$11.93	430225 \$13.72	406047-1 \$14.31

V220 Vinyl Railing Replacement Components



Top Rail



Aluminum Insert

***V210 RAILS (PAGE 74) ARE USED AS THE BOTTOM RAIL FOR V220 VINYL KITS.**

Replacement Screw Packs *not shown*

V220 Bracket Screw Pack - Level	401089 \$7.06
V220 Bracket Screw Pack - Stair 4" screws, pins and cap plugs not included	401089A \$7.06
V220 Bracket Screw and Pins Pack - Stair cap plugs not included	401099 \$7.31

Replacement Aluminum Inserts

Item Description	Length	Item
Top Rail Aluminum Insert	6'	401035A \$73.68
Top Rail Aluminum Insert	8'	401037A \$98.24
Top Rail Aluminum Insert	10'	401039A \$122.81

Replacement Rails for Square Balusters • Top* - LEVEL

Length	White	Almond	Khaki
6'	401110 \$41.47	431000 \$47.69	406105 \$49.76
8'	401150 \$55.30	431010 \$63.59	406125 \$66.36
10'	401170 \$69.13	431020 \$79.49	406155 \$82.95

Replacement Rails for Square Balusters • Top* - STAIR

Length	Angle	White	Almond	Khaki
6'	29°-35°	401110A \$41.47	431001 \$47.69	406106 \$49.76
6'	36°-41°	401111 \$41.47	431002 \$47.69	406107 \$49.76
8'	29°-35°	401130 \$55.30	431011 \$63.59	406145 \$66.35
8'	36°-41°	401131 \$55.30	431012 \$63.59	406147 \$66.35

Replacement Rails for Colonial Balusters • Top* - LEVEL

Length	White	Almond	Khaki
6'	401115 \$41.47	431003 \$47.69	406104 \$49.76
8'	401155 \$55.30	431013 \$63.59	406124 \$66.36
10'	401175 \$69.13	431021 \$79.49	406154 \$82.95

Replacement Rails for Colonial Balusters • Top* - STAIR

Length	Angle	White	Almond	Khaki
6'	29°-35°	401116 \$41.47	431004 \$47.69	406112 \$49.76
6'	36°-41°	401117 \$41.47	431005 \$47.69	406113 \$49.76
8'	29°-35°	401135 \$55.30	431014 \$63.59	406144 \$66.35
8'	36°-41°	401136 \$55.30	431015 \$63.59	406146 \$66.35

Replacement Rails for Round Aluminum Baluster • Top* - LEVEL

Length	White	Almond	Khaki
6'	401112 \$41.47	430825 \$47.69	406160 \$49.76
8'	401151 \$55.30	430826 \$63.59	406161 \$66.36
10'	401171 \$69.13	430827 \$79.49	406162 \$82.95

Replacement Rails for Round Aluminum Baluster • Top* - STAIR

Length	White	Almond	Khaki
6'	401113 \$41.47	430828 \$47.69	406163 \$49.76
8'	401132 \$55.30	430829 \$63.59	406164 \$66.35

Replacement Vinyl Balusters *not shown*

Item Description	White	Almond	Khaki
Square Baluster for 36" Railing 1-3/8" x 1-3/8" x 31-3/4"	900333 \$8.29	435500 \$9.53	905611 \$9.94
Square Baluster for 42" Railing 1-3/8" x 1-3/8" x 38-1/2"	420320 \$8.93	435502 \$10.27	905612 \$10.72
Colonial Baluster for 36" Railing 1-1/4" x 1-1/4" x 32"	900133 \$12.81	435520 \$14.73	905630 \$15.37
Colonial Baluster for 42" Railing 1-1/4" x 1-1/4" x 38-1/4"	900135 \$14.32	435521 \$16.47	905631 \$17.19

V410

SERIES
VINYL RAILING

RAILING COLOR

White



FEATURES & BENEFITS

- A Bold & Stately Profile - Perfect For Historical Renovations
- Durable & Fade Resistant - Withstands Extreme Weather Conditions With UV Protection
- Worry-Free Maintenance With Superior Structural Integrity - Reinforced With Aluminum In Both Top & Bottom Rails

INFILL OPTIONS



Square Vinyl



Turned Vinyl

RAILING HEIGHTS

36" Residential • 42" Commercial
Meets IRC, IBC Standards

RAILING LENGTHS

4', 6', 8', 10' Level • 4', 6', 8' Stair*

Aluminum Reinforced Top & Bottom Rail

**Stair Rail Available Special Order*

KITS INCLUDE

Top & Bottom Rails,
Mounting Brackets & Hardware

**Balusters Sold Separately*

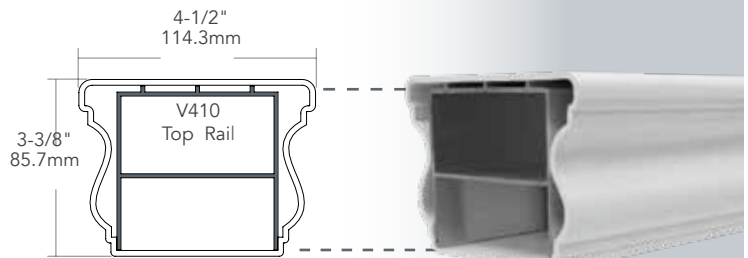

Top Rail

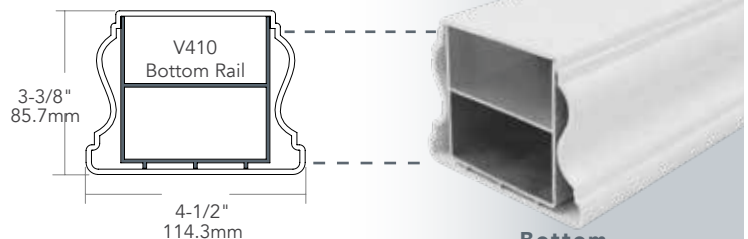

Bottom Rail

Limited Lifetime Warranty

V410 Vinyl Railing Kits



KIT INCLUDES:

- Vinyl Top Rail w/ Aluminum Inserts
- Vinyl Bottom Rail w/ Aluminum Inserts
- Mounting Brackets w/Screws

Posts, Caps, Trim and Balusters Sold Separately



V410 with White Turned Balusters

Kits for 2-5/8" Turned Balusters - LEVEL

Length	*Required Balusters	White
4'	9	400700 \$299.52
6'	13	400702 \$449.30
8'	17	400704 \$599.06
10'	22	400706 \$748.82

Kits for 1-3/4" Square Balusters - LEVEL

Length	*Required Balusters	White
4'	9	400710 \$299.52
6'	13	400712 \$449.30
8'	18	400714 \$599.06
10'	23	400716 \$748.82

Balusters - REQUIRED

Item Description	White
30" Turned Baluster for 36" Railing Height *See required balusters above per rail length option	400720 \$20.58/ea
36" Turned Baluster for 42" Railing Height *See required balusters above per rail length option	400724 \$23.45/ea
30" Square Baluster for 36" Rail Height *See required balusters above per rail length option	400721 \$17.12/ea
36" Square Baluster for 42" Rail Height *See Required Balusters Above Per Rail Length Option	400725 \$19.99/ea

V410 Stair Rail is priced the same as level sections. V410 Radius Rail is 8' minimum and SPECIAL ORDER. Obtain the rise and run the stair section and contact us for a quote.



V410 with White Turned Balusters

V410 Balustrade Brackets and Adapters

A



B



Screws included with all brackets and adapter sets.

C



D



E



F



Railing Brackets

Item Description	White
A - Top/Bottom Rail Bracket With Screws - Level	400726 \$13.23 /ea
B - Internal Rail Bracket With Screws - Stair <ul style="list-style-type: none"> • Works for All V410 Stair Degrees • Requires a sleeveover part # 400730 and is sold separately 	400728 \$13.23 /ea
C - Top/Bottom Rail Bracket Kit - Stair 32°-36° 4 brackets + screws <ul style="list-style-type: none"> • Works for 32°-36° Stair Degrees Only 	400729 \$61.00 /ea

Railing Bracket Adapters Sets

Item Description	White
D - Bracket Adapter Kit 45° - Level	400756 \$27.91
E - Round Column Bracket Adapter Kit 6" - Level	400758 \$27.91
E - Round Column Bracket Adapter Kit 8" - Level	400760 \$27.91
E - Round Column Bracket Adapter Kit 10" - Level	400762 \$27.91
F - Round Column Bracket Adapter Kit 6" - Stair NOTE: For Use with (B) - Internal Stair Rail Bracket	400764 \$27.91
F - Round Column Bracket Adapter Kit 8" - Stair NOTE: For Use with (B) - Internal Stair Rail Bracket	400766 \$27.91
F - Round Column Bracket Adapter Kit 10" - Stair NOTE: For Use with (B) - Internal Stair Rail Bracket	400768 \$27.91



V410 with White Turned Balusters

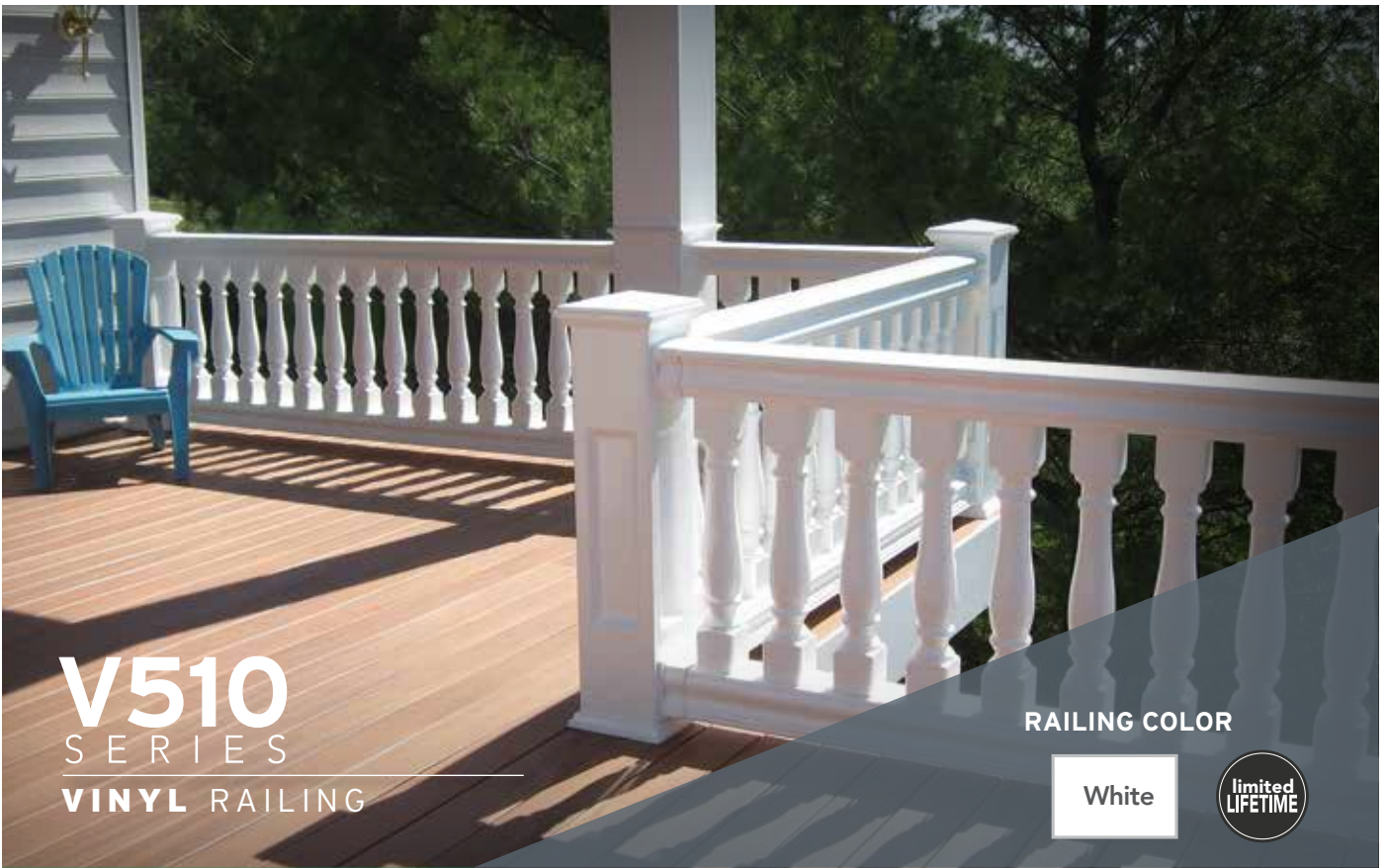

V510
SERIES
VINYL RAILING

RAILING COLOR

White



FEATURES & BENEFITS

- A Classic & Timeless Profile - Perfect for Walkways & Grand Stairways
- Durable & Fade Resistant - Withstands Extreme Weather Conditions With UV Protection
- Worry-Free Maintenance With Superior Structural Integrity - Reinforced With Aluminum In Both Top & Bottom Rails

INFILL OPTIONS



Turned Vinyl

RAILING HEIGHTS

36" Residential • 42" Commercial
Meets IRC, IBC Standards

RAILING LENGTHS

4', 6', 8', 10', 12' Level • 4', 6', 8' Stair*

Aluminum Reinforced Top & Bottom Rail

**Stair Rail Available Special Order*

KITS INCLUDE

Top & Bottom Rails,
Mounting Brackets & Hardware

**Balusters Sold Separately*

Limited Lifetime Warranty

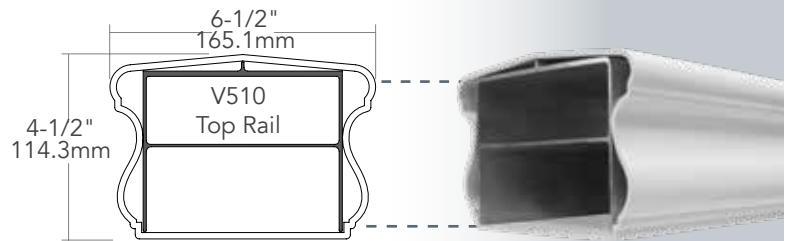

Top Rail

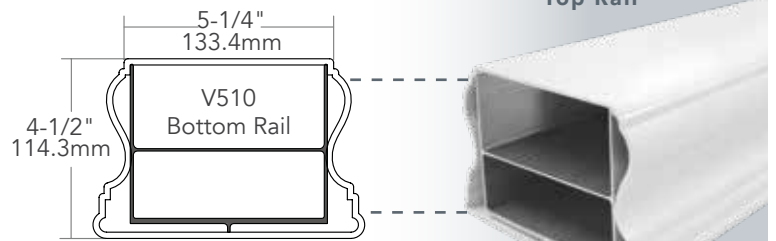

Bottom Rail

V510 Vinyl Railing Kits



KIT INCLUDES:

- Vinyl Top Rail
 - Vinyl Bottom Rail
 - Aluminum Inserts (Top, Bottom Rail)
 - Mounting Brackets w/Screws
- Posts, Caps, and Balusters Sold Separately

Railing Kits for 3-3/4" x 3-3/4" Turned Balusters - LEVEL

Length	*Required Balusters	White
4'	7	400430 \$457.90
6'	11	400432 \$658.16
8'	14	400434 \$841.58
10'	18	400436 \$1,058.71
12'	22	400438 \$1,258.99

Balusters - REQUIRED

Item Description	White
29" Turned Baluster for 36" Railing Height *See required balusters above per rail length option	400490 \$33.70/ea
35" Turned Baluster for 42" Railing Height *See required balusters above per rail length option	400494 \$38.31/ea

V410 Stair Rail is priced the same as level sections. V510 Radius Rail is 8' minimum and SPECIAL ORDER. Obtain the rise and run the stair section and contact us for a quote.



V510 with White Turned Balusters

V510 Balustrade Brackets and Adapters

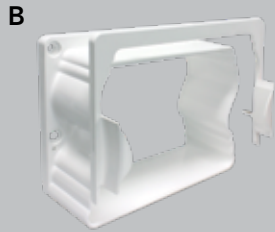
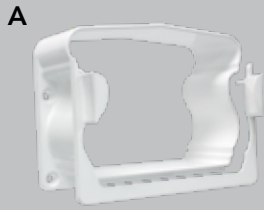

Railing Brackets	
Item Description	White
A - Top Rail Bracket With Screws- Level	400498 \$14.34 /ea
B - Bottom Rail Bracket With Screws- Level	400500 \$14.34 /ea
C - Top/Bottom Rail Bracket With Screws, 28°-45°- Stair	400502 \$14.34 /ea

Railing Bracket Adapters Sets	
Item Description	White
D - Bracket Adapter Set Kit 45° - Level	400526 \$34.81
E - Round Column Bracket Adapter Set Kit 10" - Level	400530 \$28.66
E - Round Column Bracket Adapter Set Kit 12" - Level	400532 \$28.66
F - Round Column Bracket Adapter Set Kit 8" - Stair	400534 \$34.81
F - Round Column Bracket Adapter Set Kit 10" - Stair	400536 \$34.81
F - Round Column Bracket Adapter Set Kit 12"- Stair	400538 \$34.81

Screws included with all brackets and adapter sets.

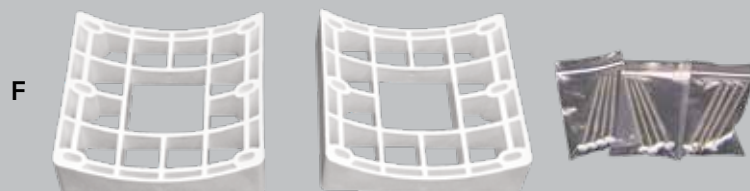
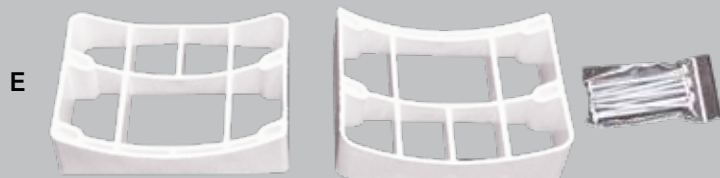

V510 with White Turned Balusters



VINYL POST ACCESSORIES

96 STRUCTURAL POST MOUNTS

97 VINYL POST SLEEVES

98 VINYL ADJUSTABLE &
STANDARD POST WRAPS

99 VINYL NEWEL POSTS

100 VINYL POST CAPS

102 VINYL POST CAP ACCENTS

103 VINYL POST ACCENTS

104 VINYL POST TRIM

Structural Post Mounts

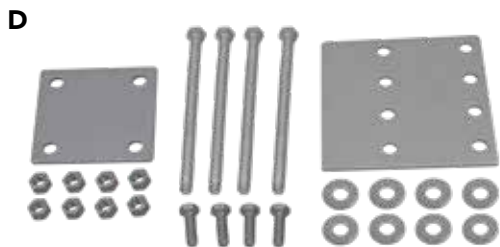

Structural Post Mounts	
Description	ITEM
A - 4" x 4" HEAVY-DUTY Structural Post Mount* <ul style="list-style-type: none"> • 1.60" square steel post double welded for maximum strength. Includes leveling flange for all surfaces, four (4) 5/16" x 1" leveling screws and leveling shims for non-level surface mounting. • Residential/Commercial • Top block can be flipped for 42" railing applications. 	401021A \$134.72
B - 4" x 4" STANDARD Structural Post Mount* <ul style="list-style-type: none"> • 1.60" square steel post includes leveling shims for non-level surface mounting. • Top block can be flipped for 42" railing applications 	401021 \$90.21
C - V500 series 8" x 8" x 37" Structural Post Mount <ul style="list-style-type: none"> • For use with V500 series railing. • Stainless steel base 	400514 \$289.00

Structural Post Mounts Accessories	
Description	ITEM
D - HEAVY-DUTY Structural Post Mount - Deck Mount Kit** <ul style="list-style-type: none"> • Kit Includes: One (1) 4-hole top mounting plate, one (1) 8-hole bottom mounting plate, four (4) 3/8" x 6" mounting bolts, eight (8) 3/8" washers, eight (8) 3/8" nuts and four (4) 5/16" x 1" leveling screws • Requires the use of a post trim ring to cover top mounting plate. 	401053 \$30.32
E - Joist Bracket for Structural Post Mounts	401002A \$57.00
F - 5" x 5" Spacer Block Kit for 4" x 4" Structural Post Mounts <ul style="list-style-type: none"> • Slides over structural post mounts • Kit includes two (2) blocks and screws • For use with standard or heavy-duty structural post mount 	401061 \$43.60
G - V400 Series 6" x 6" Spacer Block Kit <ul style="list-style-type: none"> • Use with (A) 4" x 4" HEAVY-DUTY Structural Post • Slides over structural post mounts - two (2) Blocks per kit with screws 	400745 \$46.01

* (A) 4" x 4" HEAVY-DUTY Structural Post Mount and (B) 4" x 4" structural post mounts are coated with a heavy duty, two-layer protective textured finish designed and tested to resist corrosion in exterior applications.

** All components of the FAIRWAY® Structural Post Mount - Deck Mount Kit are coated with a three layer (metallic zinc layer, high-grade anti-corrosion chemical conversion film and baked ceramic surface coating), heavy-duty, high-grade metal surface processing technology that resists corrosion in exterior applications.

Vinyl Post Sleeves

Available in 5 Sizes



Vinyl Post Sleeves 4"			
Item Description	White	Almond	Khaki
Vinyl Post Sleeve 4" x 4" x 39"	400346 \$26.62	430510 \$30.61	400348 \$31.94
Vinyl Post Sleeve 4" x 4" x 48"	401018A \$29.35	430511 \$33.76	406018A \$35.23
Vinyl Post Sleeve 4" x 4" x 96"	401020A \$57.04	430512 \$65.59	406020A \$68.44
Vinyl Post Sleeve 4" x 4" x 108"	401010A \$58.66	430513 \$67.46	406010 \$70.40
Vinyl Post Sleeves 5"			
Item Description	White	Almond	Khaki
Vinyl Post Sleeve 5" x 5" x 48"	407030 \$43.57	430520 \$49.61	406235 \$52.29
Vinyl Post Sleeve 5" x 5" x 96"	900024A \$75.77	430521 \$86.27	406229 \$90.02
Vinyl Post Sleeves 6"			
Item Description	White	Almond	Khaki
Vinyl Post Sleeve 6" x 6" x 108"	401068 \$78.09	430502 \$112.85	401067 \$117.76
Vinyl Post Sleeves 6-1/2"			
Item Description	White	Almond	Khaki
Vinyl Post Sleeve 6-1/2" x 6-1/2" x 108"	407040 \$172.40	N/A	N/A
Vinyl Post Sleeve 6-1/2" x 6-1/2" PER FT. PRICE	UP TO 16' \$22.46/ft	N/A	UP TO 16' \$26.96/ft
Vinyl Post Sleeves 8"			
Item Description	White	Almond	Khaki
Vinyl Post Sleeve 8" x 8" x 38"	400504 \$101.06	N/A	N/A
Vinyl Post Sleeve 8" x 8" x 54"	400508 \$132.56	N/A	N/A
Vinyl Post Sleeve 8" x 8" x 120"	400512 \$286.37	N/A	N/A

PRE-DRILLED VINYL POST SLEEVE FOR CABLE RAILING ON PAGE 140.

Adjustable Vinyl Post Wraps

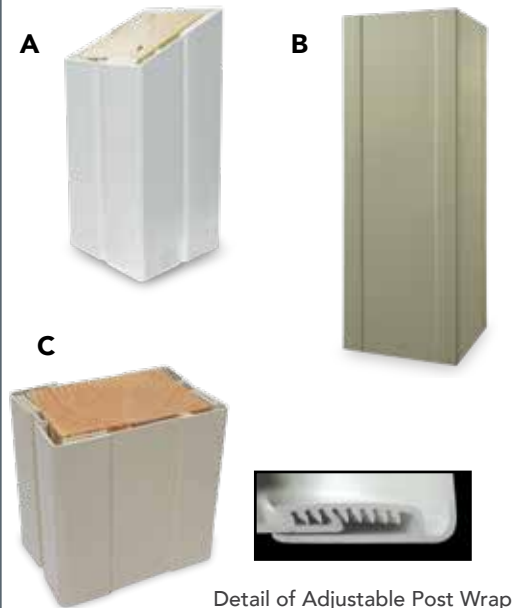

Detail of Adjustable Post Wrap Ratcheting System
Adjustable in 0.125" Increments

Adjustable Post Wrap Sizes:

4" Adj. Post Wraps Available in 96" & 120" Lengths
 6" Adj. Post Wraps Available in 96" & 120" Lengths
 8" & 10" Adj. Post Wraps Available in 120" Lengths

Adjustable Inside Dimensions:

4" Adjusts from 3-1/4" - 4-1/4"
 6" Adjusts from 5-1/4" - 6-1/4"
 8" Adjusts from 7-1/4" - 8-1/4"
 10" Adjusts from 9-1/4" - 10-1/4"

4" Adjustable Vinyl Post Wraps			
Item Description	White	Almond	Khaki
A - Adjustable Post Wrap 4" x 4" x 96"	412072 \$111.91	430540 \$128.61	412073 \$134.29
A - Adjustable Post Wrap 4" x 4" x 120"	412030 \$139.89	430541 \$160.88	412032 \$167.87
6" Adjustable Vinyl Post Wraps			
Item Description	White	Almond	Khaki
A - Adjustable Post Wrap 6" x 6" x 96"	412074 \$137.50	430542 \$159.30	412075 \$165.00
A - Adjustable Post Wrap 6" x 6" x 120"	412031 \$171.88	430543 \$197.67	412033 \$206.26
8" Adjustable Vinyl Post Wraps			
Item Description	White	Almond	Khaki
B - Adjustable Post Wrap 8" x 8" x 120"	412084 \$216.15	430545 \$248.57	412085 \$259.38
10" Adjustable Vinyl Post Wraps			
Item Description	White	Almond	Khaki
B - Adjustable post wrap 10" x 10" x 120"	412086 \$258.80	430546 \$297.62	412087 \$310.56
4" x 6" Adjustable Vinyl Post Wraps			
Item Description	White	Almond	Khaki
C - Adjustable Post Wrap 4" x 6" x 120"	412098 \$153.70	430544 \$176.76	412099 \$184.44



White Adjustable Post Wraps

Vinyl Newel Posts



A

4" Vinyl Newel

Item Description	White	Almond	Khaki
A - Vinyl Newel Post 4" x 4" x 38" - Colonial	400270 \$67.41	430408 \$76.76	400281 \$80.90
A - Vinyl Newel Post 4" x 4" x 54" - Colonial	400272 \$77.13	430409 \$87.83	400282 \$92.56

6" Vinyl Newel - Used With V410 Series

Item Description	White
B - Vinyl Newel Post 6" x 6" x 38" - Turned	400738 \$114.31
B - Vinyl Newel Post 6" x 6" x 54" - Turned	400740 \$161.38
C - Vinyl Newel Post 6" x 6" x 38" - Recessed Panel	400734 \$110.98
C - Vinyl Newel Post 6" x 6" x 54" - Recessed Panel	400736 \$161.38

B



8" Vinyl Newel - Used With V510 Series

Item Description	White
D - Vinyl Newel Post 8" x 8" x 38" - Recessed Panel	400506 \$125.05
D - Vinyl Newel Post 8" x 8" x 54" - Recessed Panel	400510 \$170.03

C



D



V410 White with Turned Newel Posts

Vinyl Post Caps

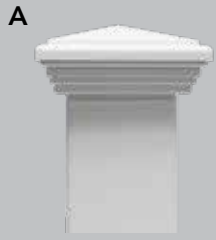

4" Vinyl Post Caps				
Item Description	White	Almond	Khaki	
A - Classic Post Cap 4"	401048 \$11.26	430201 \$12.94	406048 \$13.51	
B - Gothic Post Cap 4"	901202 \$14.69	430205 \$16.90	406225 \$17.63	
C - Ball Post Cap 4"	901211 \$11.51	430204 \$13.24	406046 \$13.82	
D - External Pyramid Post Cap 4"	901203 \$3.68	430203 \$4.23	406221 \$4.25	
E - New England Post Cap 4"	901220 \$8.36	N/A	904042 \$10.03	
F - Carriage Light Solar Post Cap 4"	901268 \$65.89	N/A	N/A	
G - Internal Pyramid Post Cap 4" (Vinyl post only)	901204 \$4.05	N/A	N/A	
H - Harbor Post Cap 4"	901221 \$12.84	N/A	N/A	

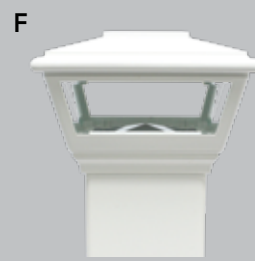

LED Post Caps & Accents

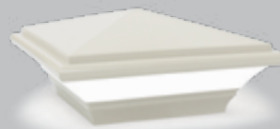

LED Post Caps
Available
See page 149

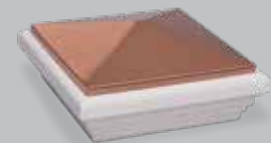

Add a Post Cap
Accent
See page 102



Vinyl Post Caps

5" Vinyl Post Caps



J



K



L



M

Item Description	White	Almond	Khaki
A - Classic Post Cap 5"	401049 \$21.65	430209 \$24.65	406049 \$25.98
B - Gothic Post Cap 5"	901200 \$19.29	N/A	N/A
C - Ball Post Cap 5"	900225 \$13.68	N/A	N/A
D - External Pyramid Post Cap 5"	901201 \$6.67	430211 \$7.60	900736 \$8.01
E - New England Post Cap 5"	901222 \$18.16	N/A	N/A
G - Internal Pyramid Post Cap (Vinyl Post Only) 5"	900212 \$6.83	N/A	900732 \$8.20

6" Vinyl Post Caps

Item Description	White	Almond	Khaki
J - Pyramid Post Cap 6"	400752 \$15.08	N/A	N/A
K - Classic Post Cap 6"	400754 \$21.62	430213 \$24.61	900313 \$25.94

6-1/2" Vinyl Post Cap

Item Description	White	Almond	Khaki
J - External Pyramid Post Cap 6-1/2"	900308 \$13.67	N/A	900738 \$16.41

8" Vinyl Post Caps

Item Description	White
L - 8" Classic Post Cap	400522 \$21.61
M - 8" Pyramid Post Cap	400520 \$15.07



White Carriage LED Light Post Cap

Vinyl Post Cap Accents

Now you can add style to your FAIRWAY® Classic Cap!

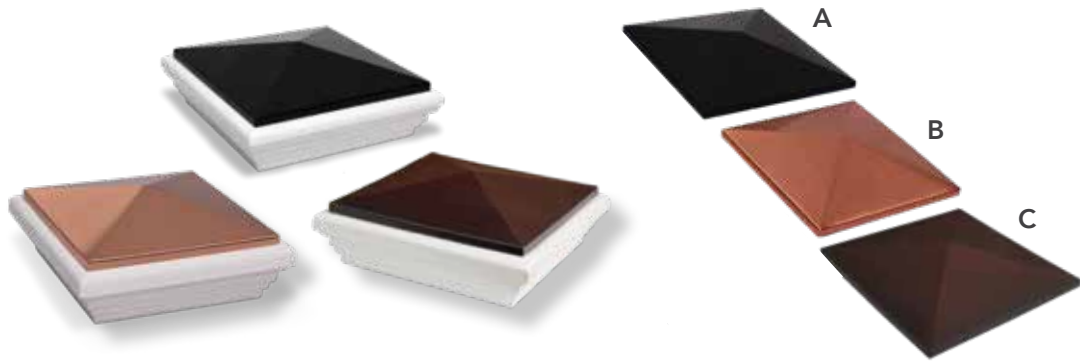

Post Cap Accents		
Item Description	4"	5"
A - Post Cap Accent - Black	901310 \$13.54	901320 \$17.80
B - Post Cap Accent - Copper	901311 \$17.80	901321 \$22.58
C - Post Cap Accent - Brushed Bronze	901312 \$17.80	901322 \$22.58



5-1/4" Carriage Light Post Cap



Post Cap Accent - Copper



5-1/4" Carriage Light Post Cap with Copper Cap



Post Cap Accent - Copper



Post Cap Accent - Black

Vinyl Post Accents

A



Gingerbread Scroll
(12-1/4" x 10-3/8" x 1")

Scrolls for Porch Posts

Item Description	White
A - Gingerbread Scroll Accent 12-1/4" x 10-3/8" x 1"	400295 \$45.02
B - Vinyl Porch Spandrel Kit 6' Includes Rails, Spindles and Mounting Bracket Kit 12" Installed Height	400170 \$146.66
C - Vinyl Porch Spandrel Kit 8' Includes Rails, Spindles and Mounting Bracket Kit 12" Installed Height	400172 \$195.54
D - Vinyl Porch Spandrel Kit 10' Includes Rails, Spindles and Mounting Bracket Kit 12" Installed Height	400174 \$244.42

B, C, D

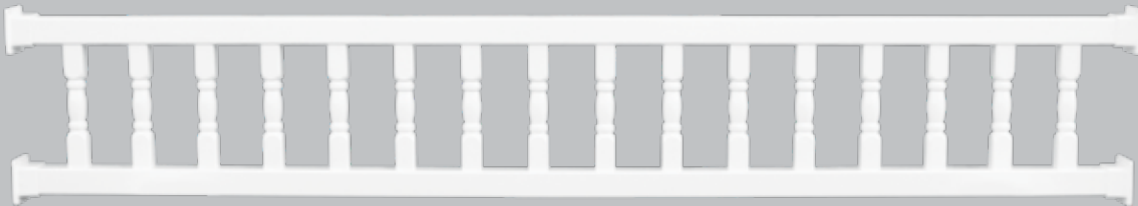

Square Spandrel Kits Available as a Special Order Item



Vinyl Post Trim

Post Sleeve Vinyl Trim

Item Description	White	Almond	Khaki
A - Classic Post Trim 4" (1pc.)	900350 \$7.26	430202 \$8.35	406210 \$8.71
A - Classic Post Trim 5" (1pc.)	900354 \$13.32	430210 \$15.16	900734 \$15.98
B - Classic Post Trim 6" (1pc.)	400750 \$16.97	N/A	N/A
B - Classic Post Trim 8" (1pc.)	400525 \$16.97	N/A	N/A
C - Universal Post Trim - <u>Sleeve</u> (4pc.) Easily Field Modified for 4" - 6-1/2" Posts Maximum Expansion size 6-3/4"	902016 \$11.54	430221 \$13.27	902018 \$13.84
D - Universal Post Trim - <u>Porch</u> (4pc.) Easily Field Modified for 4" - 6-1/2" Posts Maximum Expansion Size 6-3/4"	902013 \$11.54	430220 \$13.27	902015 \$13.84
E - Universal Post Trim - <u>Large</u> (4pc.) Easily Field Modified fr 8-1/2" - 12-1/2" Posts Maximum Expansion Size 12-1/2"	902022 \$30.44	N/A	902024 \$36.52
F - Universal Post Trim - <u>Wrap</u> (4pc.) Easily Field Modified for 8" - 12-1/2" Posts Maximum Expansion Size 12-1/2"	902022PW \$30.44	N/A	902024PW \$36.52



A



B

1/4" Radius Corner



C

7/16" Radius Corner



D

1/4" Radius Corner



E

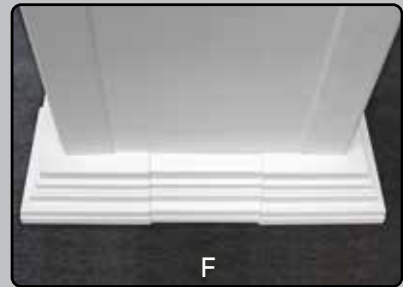

F



V220 White with Acrylic Panels and Classic Post Trim

Vinyl Post Trim

Universal Post Trim – Post / Sleeve • Fit Sheet

Item Description	SLEEVE	PORCH	LARGE
4" Vinyl Post Sleeve	C		
5" Vinyl Post Sleeve	C		
6-1/2" Vinyl Post Sleeve		D	
8" Vinyl Post Sleeve			E
4" Newel Post - Turned		D	
6" Newel Post - Turned		D	
6" Newel Post - Recessed Panel	C		
8" Newel Post - Recessed Panel			E
4" Adjustable Post Wrap	C		
6" Adjustable Post Wrap	C		
8" Adjustable Post Wrap			F - WRAP
10" Adjustable Post Wrap			F - WRAP
4" Porch Post - Colonial		D	
5" Porch Post - Colonial		D	
4" Porch Post - Traditional		D	
5" Porch Post - Traditional		D	
4" Porch Post - Square		D	
5" Porch Post - Square		D	
6" Porch Post - Recessed Panel	C		
6" Porch Post - Turned		D	
4" & 5" Khaki Porch Post - Square	C		
4" Composite Post Sleeve		D	
5-1/4" Composite Post Sleeve		D	



V210 White with Square Balusters and White Classic Post Trim



V110 Khaki with Square Balusters and Khaki Classic Post Trim



V220 White with Colonial Balusters and White Classic Post Trim

PORCH POSTS AND COLUMNS

COLORS

White

Almond

Khaki



FEATURES & BENEFITS

- Durable & Fade Resistant - Withstands Extreme Weather Conditions With UV Protection
- Worry-Free Maintenance With Superior Structural Integrity
- Quick & Easy Installation With Concealed Hardware
- Provides A Secure Uplift With Mounting Plates

PREMIER VINYL COLUMNS:

- 8" Round Column - Axial Load: 19,500 lbs.; Mounting Uplift Plate Load: 1,585 lbs.
- 8" Square Column - Axial Load: 20,238 lbs.; Mounting Uplift Plate Load: 908 lbs.
- 10" Round Column - Axial Load: 18,417 lbs.; Mounting Uplift Plate Load: 1,600 lbs.

VINYL STRUCTURAL PORCH POSTS

- 4" Post-Axial Load: 7,883 lbs.; Mounting Uplift Load: 1,637 lbs.
- 5" Post-Axial Load: 11,571 lbs.; Mounting Uplift Load: 1,854 lbs.
- 6" Post-Axial Load: 20,711 lbs.; Mounting Uplift Load: 1,303 lbs.

Performance Test Results are Available at FairwayRailing.com

Premier Vinyl Columns



Accent Rings not included with Column

8" Premier Columns

Item Description	White
Premier Round Vinyl Column - 8" x 9' Straight	400120 \$339.75
Premier Round Vinyl Column - 8" x 9' Tapered	400125 \$354.15
Premier Round Vinyl Column - 8" x 10' Tapered	400130 \$388.70
Premier Square Vinyl Column - 8" x 8" x 9' Straight	400143 \$371.80

10" Premier Columns

Item Description	White
Premier Round Vinyl Column - 10" x 9' Tapered	400135 \$417.49
Premier Round Vinyl Column - 10" x 10' Tapered	400140 \$431.88

Average Ultimate Performance Test Results:

8" Round Column - Axial Load: 19,500 lbs.; Uplift Load: 1,585 lbs.

8" Square Column - Axial Load: 20,238 lbs.; Uplift Load: 908 lbs.

10" Round Column - Axial Load: 18,417 lbs.; Uplift Load: 1,600 lbs.



V510 White with Turned Balusters and Premier Vinyl Columns

Premier Vinyl Columns



Cut away view of internal structural support system

Premier Vinyl Column Cap, Base & Accent Ring

Item Description	White
8" Vinyl Cap/Base with Accent Ring Premier Round Vinyl Column - Straight	400150 \$87.74
8" Vinyl Cap/Base with Accent Ring Premier Round Vinyl Column - Tapered	400152 \$87.74
8" Vinyl Cap/Base with Accent Ring Premier Square Vinyl Column - Straight	400153 \$106.82
10" Vinyl Cap/Base with Accent Ring Premier Round Vinyl Column - Tapered	400154 \$106.82



Top & Bottom Column Mounting Plates are Included w/Columns

Round Column Vinyl Cap and Base with Accent Ring



Square Column Vinyl Cap and Base with Accent Ring

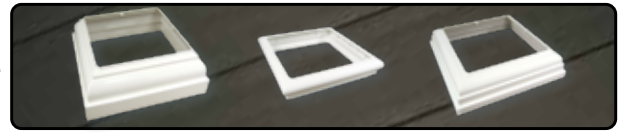

Load bearing capacity is dependent on the concentric loading of the columns. It is the user's responsibility to ensure proper application and use of data, relating to design, dead and live load, wind, snow, seismic loads and safety factors.



V410 White with Turned Balusters and Premier Vinyl Columns

Vinyl Structural Porch Posts



Vinyl Structural Porch Post

Includes Structural Insert and Two Mounting Plates

Structural Performance Test Results:

4" Post - Axial Load: 7,883 lbs • Mounting Uplift Plate Load: 1,637 lbs

5" Post - Axial Load: 11,571 lbs • Mounting Uplift Plate Load: 1,854 lbs

6" Post - Axial Load: 20,711 lbs • Mounting Uplift Plate Load: 1,303 lbs

Item Description	White	Almond	Khaki
A - Porch Post - Recessed Panel 6" x 6" x 108"	400743 \$378.97	N/A	N/A
B - Porch Post - Colonial 4" x 4" x 108"	400370 \$162.73	430402 \$180.76	400394 \$195.27
B - Porch Post - Colonial 5" x 5" x 108"	400372 \$179.28	430413 \$199.15	400396 \$215.14
C - Porch Post - Traditional 4" x 4" x 108"	400374 \$162.73	430404 \$180.76	400398 \$195.27
C - Porch Post - Traditional 5" x 5" x 108"	400376 \$179.28	430415 \$199.15	400400 \$215.14
D - Porch Post - Square 4" x 4" x 108"	400378 \$162.73	430403 \$180.76	400402 \$195.27
D - Porch Post - Square 5" x 5" x 108"	400380 \$179.28	430414 \$199.15	400404 \$215.14
E - Porch Post - Turned 6" x 6" x 108"	400742 \$378.97	N/A	N/A
Replacement 4" Porch Post Plate	400289 \$25.74	430418 \$29.31	400289B \$30.88
Replacement 5" Porch Post Plate	400288 \$25.74	430419 \$29.31	400288B \$30.88



Porch post plate swivels to install easily in new or existing structures.



4" & 5" Porch Post Cross Section View - Full length extruded aluminum center insert.

Vinyl Lamp Posts

Includes Light Adapter - Light Fixture Not Included

Item Description	White	Khaki
B - 5" x 5" Lamp Post - Colonial	400240 \$156.61	400242 \$187.93
C - 4" x 4" Lamp Post - Traditional	400251 \$150.88	400251B \$181.05
C - 5" x 5" Lamp Post - Traditional	400230 \$156.61	400231 \$187.93

It is the user's responsibility to ensure proper application and use of data, relating to design, dead and live load, wind, snow, seismic loads and safety factors.

Adjustable Vinyl Post Wraps

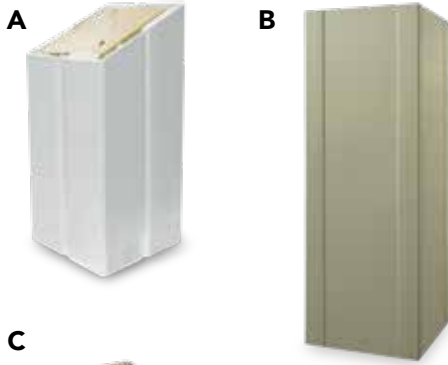

Detail of Adjustable Post Wrap Ratcheting System
Adjustable in 0.125" Increments

Adjustable Post Wrap Sizes:

4" Adj. Post Wraps Available in 96" & 120" Lengths
 6" Adj. Post Wraps Available in 96" & 120" Lengths
 8" & 10" Adj. Post Wraps Available in 120" Lengths

Adjustable Inside Dimensions:

4" Adjusts from 3-1/4" - 4-1/4"
 6" Adjusts from 5-1/4" - 6-1/4"
 8" Adjusts from 7-1/4" - 8-1/4"
 10" Adjusts from 9-1/4" - 10-1/4"

4" Adjustable Vinyl Post Wraps

Item Description	White	Almond	Khaki
A - Adjustable Post Wrap 4" x 4" x 96"	412072 \$111.91	430540 \$128.61	412073 \$134.29
A - Adjustable Post Wrap 4" x 4" x 120"	412030 \$139.89	430541 \$160.88	412032 \$167.87

6" Adjustable Vinyl Post Wraps

Item Description	White	Almond	Khaki
A - Adjustable Post Wrap 6" x 6" x 96"	412074 \$137.50	430542 \$159.30	412075 \$165.00
A - Adjustable Post Wrap 6" x 6" x 120"	412031 \$171.88	430543 \$197.67	412033 \$206.26

8" Adjustable Vinyl Post Wraps

Item Description	White	Almond	Khaki
B - Adjustable Post Wrap 8" x 8" x 120"	412084 \$216.15	N/A	412085 \$259.38

10" Adjustable Vinyl Post Wraps

Item Description	White	Almond	Khaki
B - Adjustable post wrap 10" x 10" x 120"	412086 \$258.80	N/A	412087 \$310.56

4" x 6" Adjustable Vinyl Post Wraps

Item Description	White	Almond	Khaki
C - Adjustable Post Wrap 4" x 6" x 120"	412098 \$153.70	N/A	412099 \$184.44



White Adjustable Post Wraps

VINYL PERGOLA

PERGOLA COLOR

White



- Low-Maintenance Components Can Create Any Designed Pergola System
- All Components Are Sold Separately
- Post & Rail Sleeves Require Nominal Treated Lumber Or Structural Inserts For Strength & Safety
- Accepted Wood Construction Methods Apply
- Consult Your Local Building Official And/Or Structural Engineer For Specific Methods & Required Hardware

** Consult Your Local Building Official And/Or Structural Engineer For Specific Methods & Required Hardware*



White Vinyl Pergola

Vinyl Pergola

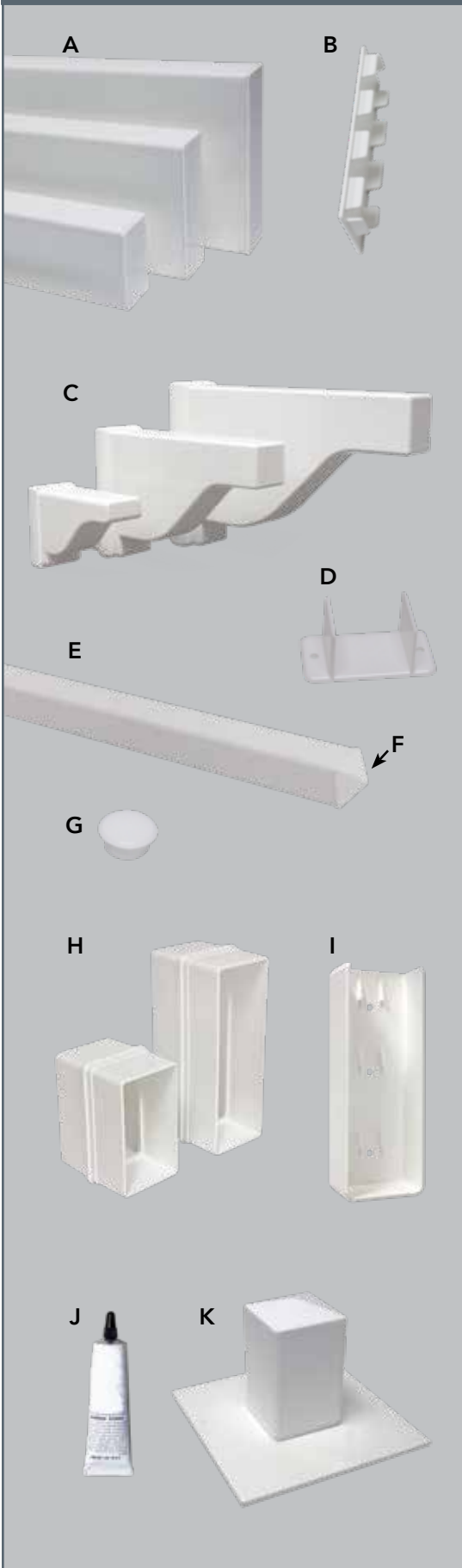

Vinyl Pergola Components

Item Description	White
A - Vinyl Sleeve - Sleeve Over Pressure Treated Wood 2" x 3-1/2" x 16'	900058 \$93.42
A - Vinyl Sleeve - Sleeve Over Pressure Treated Wood 2" x 6" x 16'	900062 \$117.03
A - Vinyl Sleeve - Sleeve Over Pressure Treated Wood 2" x 8" x 16'	900088 \$182.73
B - Flat Cap for Vinyl Sleeve 2" x 3-1/2"	900246 \$4.91
B - Flat Cap for Vinyl Sleeve 2" x 6"	900250 \$4.91
B - Flat Cap for Vinyl Sleeve 2" x 8"	900256 \$4.91
C - Scalloped Cap for Vinyl Sleeve 2" x 3-1/2"	900295 \$21.51
C - Scalloped Cap for Vinyl Sleeve 2" x 6"	900296 \$32.15
C - Scalloped Cap for Vinyl Sleeve 2" x 8"	900297 \$40.05
D - Rail Clip 2" - <i>Need 2/Sleeve</i>	900298 \$4.38
E - Vinyl Picket 1-3/8" x 1-3/8" x 16'	900332 \$25.49
F - Pyramid Cap 1-3/8"	900344 \$0.58
G - Pergola 5/8" Bolt End Plug	901026 \$0.44
H - Vinyl Sleeve Coupler 2" x 3-1/2"	900290 \$11.80
H - Vinyl Sleeve Coupler 2" x 6"	900291 \$17.53
H - Vinyl Sleeve Coupler 2" x 8"	900287 \$19.43
I - Vinyl Sleeve Mount 2" x 3-1/2" - <i>Secures to Ledger</i>	901209 \$3.49
I - Vinyl Sleeve Mount 2" x 6" - <i>Secures to Ledger</i>	901214 \$3.89
I - Vinyl Sleeve Mount 2"x 8" - <i>Secures Sleeve to Ledger Board*</i> <i>*Must be supported and secured to the ledger board per local code requirement.</i>	901217 \$5.90
J - White Vinyl Adhesive 1.5 oz.	401087 \$9.65
K - Premier Vinyl Column Pergola Adapter Kit	900293 \$79.37
#8 x 1" Square Drive Pan Head Screws 18-8SS (50/box)	900370 \$12.51
#10 x 2-1/2" Square Drive Pan Head Screws 18-8SS (50/box)	900371 \$27.51
1/4" x 4" Hex Lag Screws 18-8SS (4/bag)	900372 \$9.60

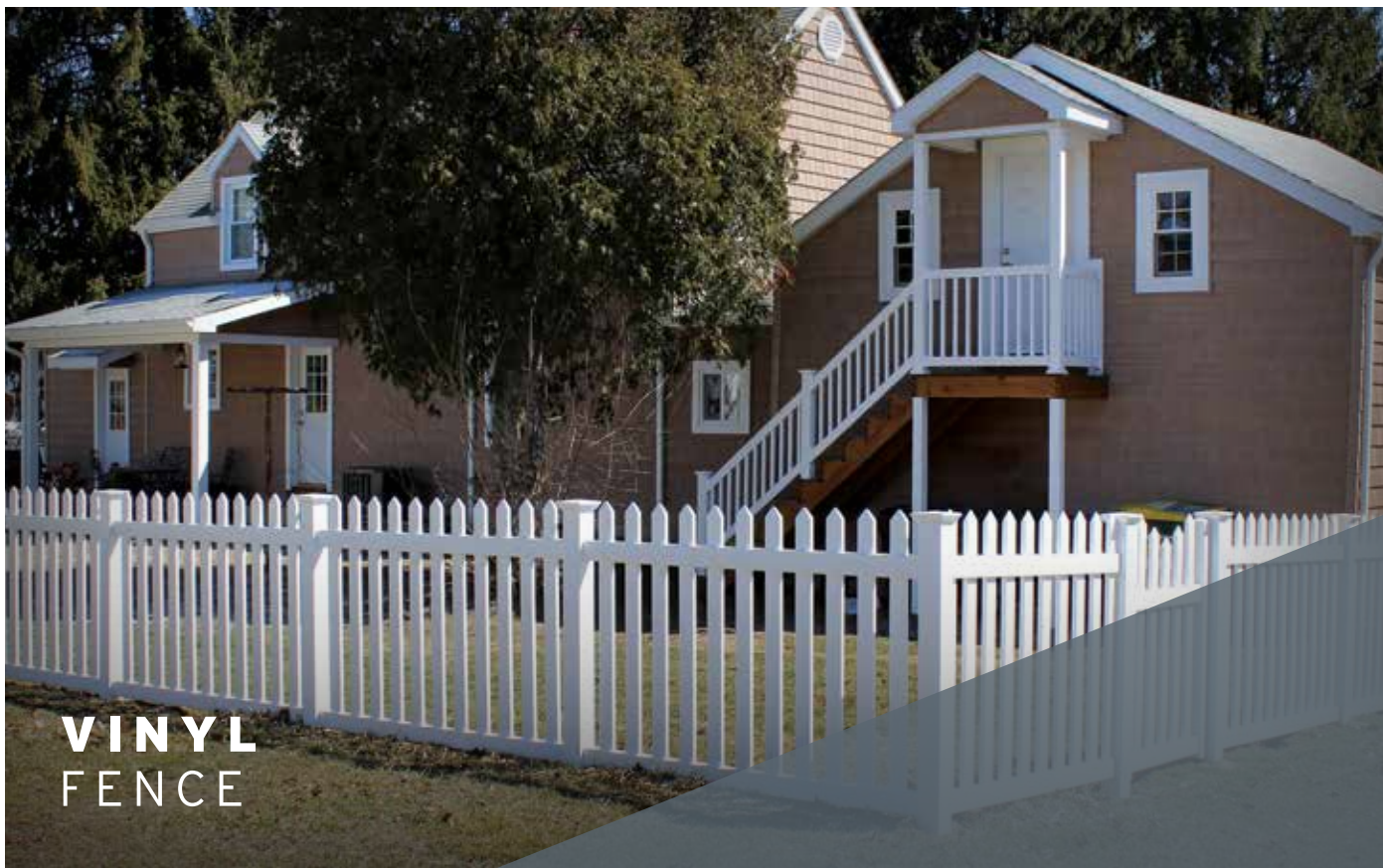

VINYL FENCE

FENCE COLORS

White

Khaki



- Available Fence Options Include: Picket, Privacy, Pool, and Post & Rail
- Neighbor Friendly - Pickets Are Routed Through Top & Bottom Rails
- Gates And Gate Hardware Available For Most Options
- Posts Are Routed for Top Rail, Bottom Rail and Mid-Rail - Where Applicable
- When Using A Gate, Add 1-1/2" To The Published Gate Width For A Perfect Fit

** Custom Gates Are Available Special Order*



White Vinyl Fence Gate

Vinyl Fence - Picket

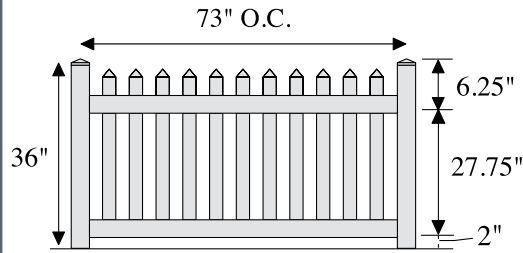

- Neighbor Friendly (Pickets routed through)
- True Picket Caps (not crimped)
- 7/8" x 3" Pickets w/3" Spacing*
- Posts & Caps Sold Separately

1 SCREW PACK IS REQUIRED FOR EVERY 2 RAIL MOUNTS

6'w x 36"h Level Picket Fence

Item Description	White	Khaki
3' Level Picket Fence (3' Height / 7/8" x 3" Picket / 3" Gap)	405070 \$165.09	405070K \$198.11

4" x 4" Level Picket Fence Posts

Item Description	White	Khaki
5' Post for 3' Level Picket Fence (Line)	405071 \$39.04	405071K \$46.85
5' Post for 3' Level Picket Fence (Corner)	405072 \$39.04	405072K \$46.85
5' Post for 3' Level Picket Fence (End)	405073 \$39.04	405073K \$46.85

Level Picket Fence Gate Includes Two Hinges, One Latch & Screws

Item Description	White	Khaki
3' Level Picket Gate * (34" Length x 3' Height / 3" Gap)	405181 \$471.26	405181K \$565.51

Fence Rail Wall Mount

Item Description	White	Khaki
2" x 3-1/2" Rail Wall Mount <small>* Screws not included, order 904047 for white wall mounts, 904050 for khaki wall mounts.</small>	901209 \$3.49	905644 \$4.18

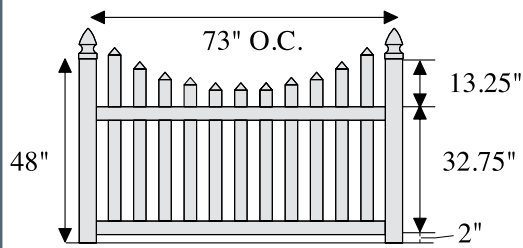

- Neighbor Friendly (Pickets routed through)
- True Picket Caps (not crimped)
- 7/8" x 3" Pickets w/3" Spacing*
- Posts & Caps Sold Separately

1 SCREW PACK IS REQUIRED FOR EVERY 2 RAIL MOUNTS

6'w x 48"h Scalloped Picket Fence

Item Description	White	Khaki
4' Scalloped Picket Fence (4' Height / 7/8" x 3" Picket / 3" Gap)	405080 \$201.47	405080K \$241.76

4" x 4" Scalloped Picket Fence Posts

Item Description	White	Khaki
6' Post for 4' Scalloped Picket Fence (Line)	405081 \$44.34	405081K \$53.20
6' Post for 4' Scalloped Picket Fence (Corner)	405082 \$44.34	405082K \$53.20
6' Post for 4' Scalloped Picket Fence (End)	405083 \$44.34	405083K \$53.20

Level Picket Fence Gate Includes Two Hinges, One Latch & Screws

Item Description	White	Khaki
4' Scalloped Picket Gate * (34" Length x 4' Height / 3" Gap)	405182 \$471.26	405182K \$565.51

Fence Rail Wall Mount

Item Description	White	Khaki
2" x 3-1/2" Rail Wall Mount <small>* Screws not included, order 904047 for white wall mounts, 904050 for khaki wall mounts.</small>	901209 \$3.49	905644 \$4.18

Rail wall mounts are optional and are offered for applications where routed fence posts cannot be used.

Vinyl Fence - Privacy

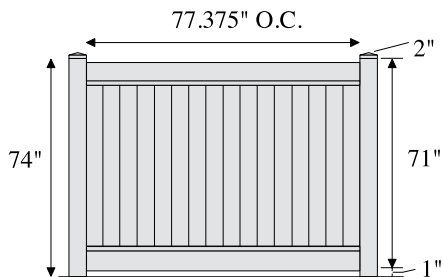

- 1-3/4" x 5-1/2" Slotted Rails*
- 7/8" x 6" T & G Panels
- Posts & Caps Sold Separately

1 SCREW PACK IS REQUIRED FOR EVERY 2 RAIL MOUNTS

6'w x 6'h Privacy Fence

Item Description	White	Khaki
6'w x 6'h Privacy Fence	405010 \$266.20	405010K \$319.44

5" x 5" Privacy Fence Posts

Item Description	White	Khaki
9' Post for 6'w x 6'h Privacy Fence - Line	405021 \$78.31	405021K \$93.97
9' Post for 6'w x 6'h Privacy Fence - Corner	405022 \$78.31	405022K \$93.97
9' Post for 6'w x 6'h Privacy Fence - End	405023 \$78.31	405023K \$93.97

Privacy Fence Gate (Includes Two Hinges, One Latch & Screws)

Item Description	White	Khaki
43-1/4"w x 6'h Privacy Fence Gate	405197 \$526.69	405197K \$632.03

Fence Rail Wall Mount and Fence U-Channel

Item Description	White	Khaki
1-3/4" x 3-1/2" Rail Wall Mount <small>* Screws not included, order 904047 for white wall mounts, 904050 for khaki wall mounts.</small>	901210 \$3.61	905641 \$4.33
1-3/4" x 5-1/2" Rail Wall Mount <small>* Screws not included, order 904047 for white wall mounts, 904050 for khaki wall mounts.</small>	901216 \$5.67	901218 \$6.80
1" x 16' U Channel	900186 \$42.35	N/A
1" x 12' U Channel	N/A	900729 \$35.86

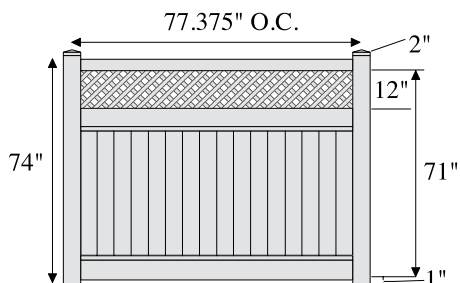

- 1-3/4" x 3-1/2" Pocket Rail
- 1-3/4" x 5-1/4" Pocket Rail
- 1-3/4" x 5-1/2" Double Pocket Rail
- 7/8" x 6" T&G Panels
- 1 Lattice Channel
- Posts & Caps Sold Separately

1 SCREW PACK IS REQUIRED FOR EVERY 2 RAIL MOUNTS

6'w x 6'h Privacy Fence w/Lattice

Item Description	White	Khaki
6' Privacy Fence with Lattice	405025 \$313.36	405025K \$376.03

5" x 5" Privacy Fence w/Lattice Posts

Item Description	White	Khaki
9' Post for 6' Privacy Fence with Lattice (Line)	405016 \$78.31	405016K \$93.97
9' Post for 6' Privacy Fence with Lattice (Corner)	405017 \$78.31	405017K \$93.97
9' Post for 6' Privacy Fence with Lattice (End)	405018 \$78.31	405018K \$93.97

Privacy Fence w/Lattice Gate (Includes Two Hinges, One Latch & Screws)

Item Description	White	Khaki
6' Privacy Fence with Lattice Gate (43-1/4" x 6' Height)	405198 \$582.13	405198K \$698.55

Fence Rail Wall Mount and Fence U-Channel

Item Description	White	Khaki
1-3/4" x 3-1/2" Rail Wall Mount - Used for Top Rail <small>* Screws not included, order 904047 for white wall mounts, 904050 for khaki wall mounts.</small>	901210 \$3.61	905641 \$4.33
1-3/4" x 5-1/2" Rail Wall Mount - Used for Mid & Bottom Rails <small>* Screws not included, order 904047 for white wall mounts, 904050 for khaki wall mounts.</small>	901216 \$5.67	901218 \$6.80
1" x 16' U Channel	900186 \$42.35	N/A
1" x 12' U Channel	N/A	900729 \$35.86

Rail Wall Mounts are optional and are offered for applications where routed fence posts cannot be used.

All dimensions are for reference and nominal.

Vinyl Fence - Pool

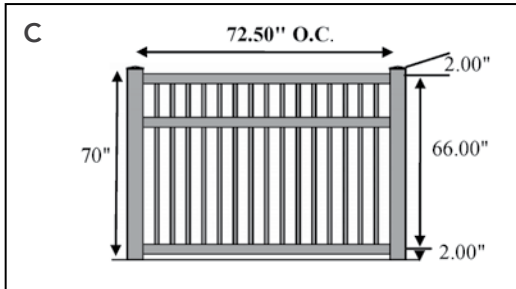
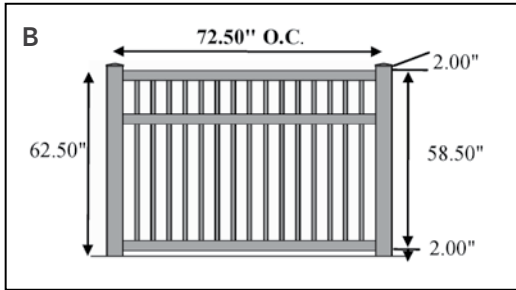
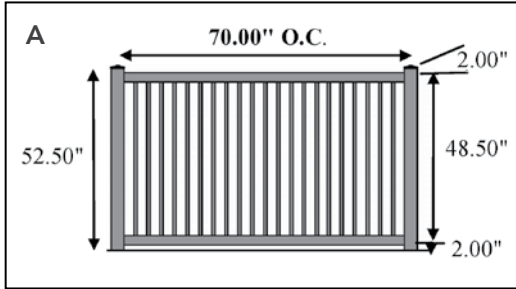

Routed Pool Fence

Item Description	Suggested Post Length	White	Khaki
A - 6'w x 4'h Routed Pool Fence 1-3/8" x 1-3/8" Picket / 1-3/4" Gap*	6' post	PLR46-W142 \$321.83	PLR46-K142 \$386.19
B - 6'w x 5'h Routed Pool Fence 1-3/8" x 1-3/8" Picket / 3" Gap*	7' post	PLR56-WF13 \$348.97	PLR56-KF13 \$418.76
C - 6'w x 6'h Routed Pool Fence 1-3/8" x 1-3/8" Picket / 3" Gap*	8' post	PLR66-WF14 \$387.36	PLR66-KF14 \$464.84

Fence Posts

Item Description	White	Khaki
4" x 4" x 7' Post NOTE: Indicate Line, Corner or End at time of order.	CW4X7POST \$51.73	CK4X7POST \$62.08
4" x 4" x 8' Post NOTE: Indicate Line, Corner or End at time of order.	CW4X8POST \$59.12	CK4X8POST \$70.94
4" x 4" x 9' Post NOTE: Indicate Line, Corner or End at time of order.	CW4X9POST \$66.51	CK4X9POST \$79.81

Fence to Wall Mounts

Item Description	White	Khaki
2" x 3-1/2" Rail Wall Mount <small>* Screws not included, order 904047 or 905050</small>	901209 \$3.49	905644 \$4.18

Rail wall mounts are optional and are offered for applications where routed fence posts cannot be used.

Secure, define and accent the area around your pool without being obtrusive.

- 1-3/8" Square Pickets
- Varying heights, widths and picket spacing available to accommodate your preference for privacy or accent
- Built to ICC code standards for security and compliance
- Matching gates available - call for gate pricing and specifications



White Vinyl Picket Fence

Custom order fence is made specifically to order - Custom order fence material can not be returned.

All dimensions are for reference and nominal.

Vinyl Fence - Post & Rail

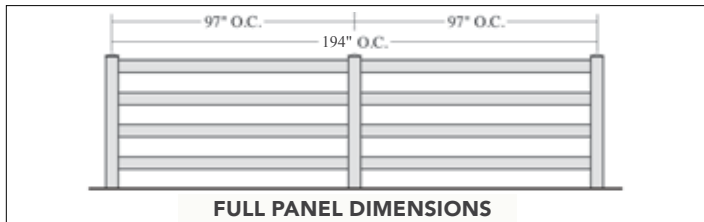
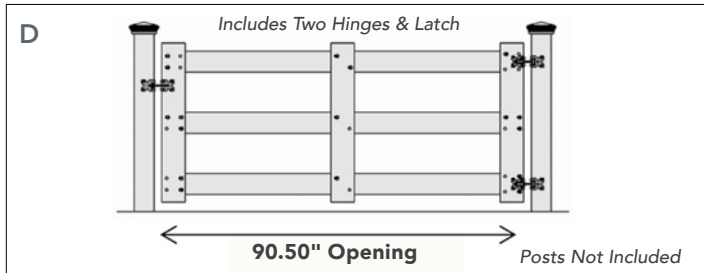
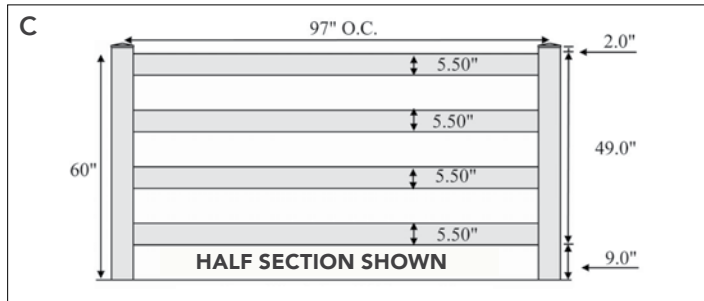
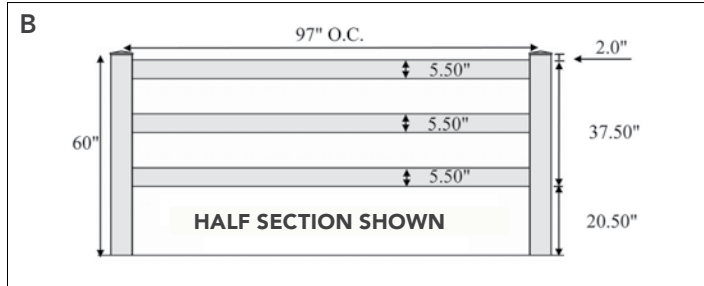
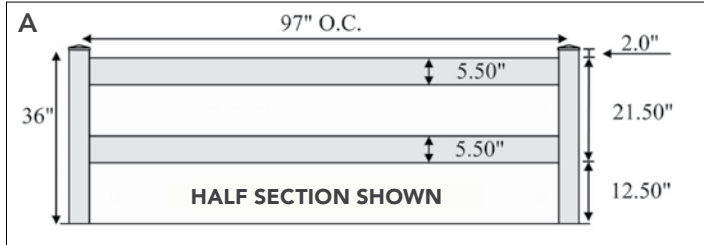

Great for accenting corners or defining an area around your field, ranch or farm.

- 2-Rail / 36" height
- 3-Rail / 60" height (Most Popular)
- 4-Rail / 60" height
- Durable webbed rail for toughness & added strength

When using for stock animal containment Post & Rail fence must be used in conjunction with an electric wire or ribbon fence.

Ask About Custom Options - 15% Up charge May Apply

2-Rail Posts

Item Description	White
A - 2-Rail Post - Line 5" x 5" x 5'	900142 \$29.04
A - 2-Rail Post - Corner 5" x 5" x 5'	900144 \$29.04
A - 2-Rail Post - End 5" x 5" x 5'	900146 \$29.04

3-Rail Posts

Item Description	White
B - 3-Rail Post - Line 5" x 5" x 7'	900154 \$37.67
B - 3-Rail Post - Corner 5" x 5" x 7'	900156 \$37.67
B - 3-Rail Post - End 5" x 5" x 7'	900158 \$37.67

4-Rail Posts

Item Description	White
C - 4-Rail Post - Line 5" x 5" x 7'	900160 \$40.86
C - 4-Rail Post - Corner 5" x 5" x 7'	900162 \$40.86
C - 4-Rail Post - End 5" x 5" x 7'	900164 \$40.86

Vinyl Ribbed Rails

Item Description	White
Vinyl Ribbed Rail 1-1/2" x 5-1/2" x 16'	900174 \$48.04

Fence to Wall Mounts

Item Description	White
1-1/2" x 5-1/2" Rail Wall Mount <small>* Screws not included, order 904047 or 905050</small>	901213 \$3.60

Gates

Includes Two Hinges, One Latch & Screws

Item Description	White
D - Vinyl Gate 89" call for availability	405185 \$793.58



Always Check Your Local Code Requirements.
Please call for 2,000 feet or more.

Custom Order Fence is made specifically to order, Custom Order Fence material can not be returned.

Vinyl Fence Components

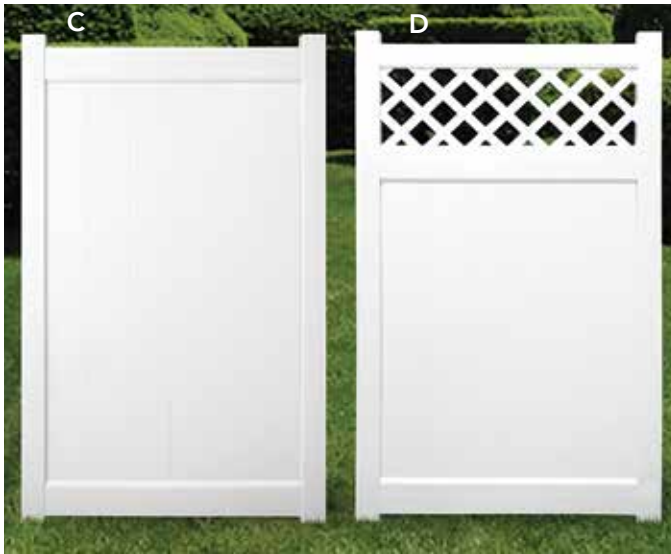
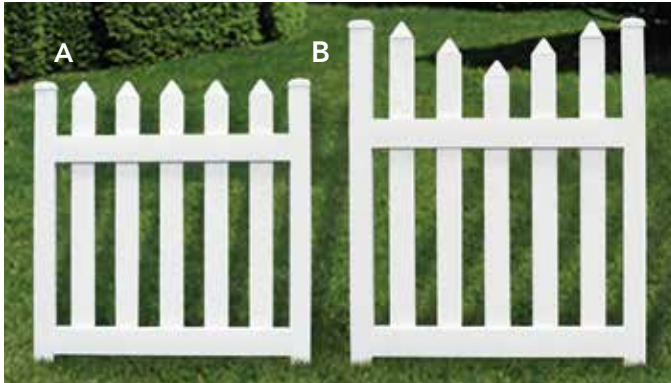

Fence Gates

Item Description	White	Khaki
A - 3' Level Picket Gate 34" w x 3' h / 3" Gap	405181 \$471.26	405181K \$565.51
B - 4' Scalloped Picket Gate 34" w x 4' h / 3" gap	405182 \$471.26	405182K \$565.51
C - 6' Privacy Gate 43-1/4" w x 6' h	405197 \$526.69	405197K \$632.03
D - 6' Privacy Gate with Lattice 43-1/4" w x 6' h	405198 \$582.13	405198K \$698.55

Gate Hardware

Item Description	Black
E - Magna Latch Top Pull Safety Gate Latch	905100 \$138.16
F - External Access Kit	905103 \$46.73
G - General Purpose Gate Latch Left or Right Hinge <i>*Item is included with gate purchase</i>	905102 \$61.93
H - Gate Handle	905104 \$12.86
I - 4" Gate Hinge (pair) - Includes 2 - Heavy Duty / Self Closing Gate Hinges and Snap-on Trim <i>*Item is included with gate purchase</i>	905105P \$59.43
J - Gate Drop Rod	901040 \$128.00
K - Screw Pack for Gates	401094 \$7.45

E
Top Pull
Model



Gate Tip:

Add 1-1/2" to the published gate width to obtain the vinyl post to vinyl post finished dimension.

Each gate includes two hinges and one latch with screws.

**Vertical Side Rails For Secure Hinge Attachment
No Diagonal Cross Brace**



G



H



I





CP310

SERIES

COMPOSITE RAILING

RAILING COLORS

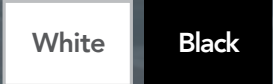

FEATURES & BENEFITS

- Engineered With A Proprietary Crosspolymer Material For Superior Core Properties
- Durable & Fade Resistant - Withstands Extreme Weather Conditions
- Distinct, Classic Profile - Won't Compromise Your View
- Low-Maintenance - No Painting, Sealing Or Staining
- Dimensionally Stable - Won't Twist, Rot Or Splinter
- Environmentally Friendly - Made From Recycled Materials
- Hidden Hardware With Concealed Fasteners
- Two-Piece Top Rail - Ideal For In-Rail LED Lighting

INFILL OPTIONS

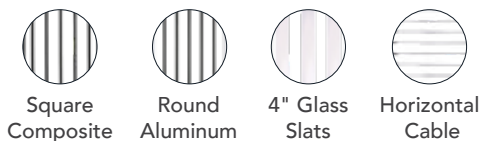

RAILING HEIGHTS

36" Residential • 42" Commercial
Meets IRC, IBC Standards

RAILING LENGTHS

6', 8', 10'* Level • 6', 8' Stair
**Length Not Available In Glass Slats*

KITS INCLUDE

Top Rail, Sub-Rail & Bottom Rails,
Balusters/Infill, Mounting Brackets
& Hardware

20-Year Limited Warranty

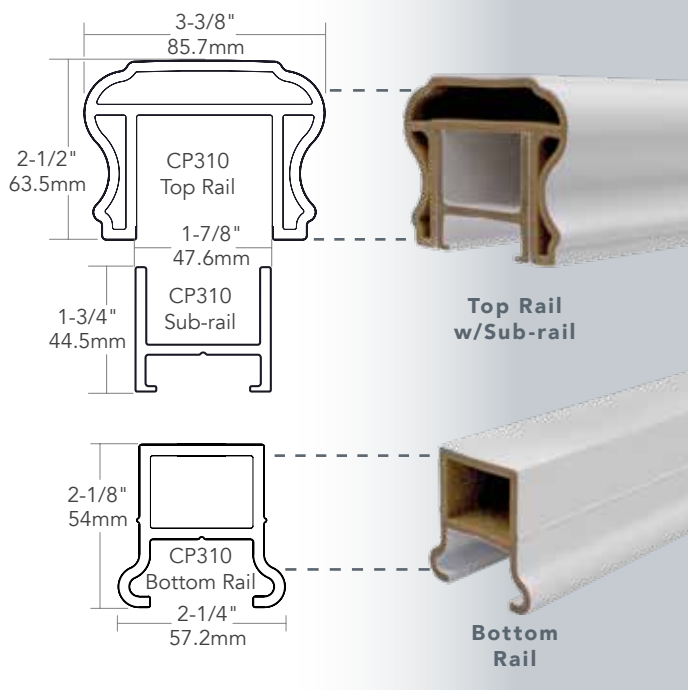

CP310 Composite Railing Kits



KIT INCLUDES:

- Top Rail
- Top Sub-Rail
- Bottom Rail
- Square Composite Balusters
- Rail Support
- Mounting Brackets w/Screws

Posts, Caps and Trim Sold Separately

Square Composite Baluster Kits - LEVEL

Height	Length	White	Black
36"	6'	400800 \$216.97	400801 \$238.67
36"	8'	400802 \$289.31	400803 \$318.23
36"	10'	400922 \$361.61	400923 \$397.78
42"	6'	400808 \$249.52	400809 \$274.48
42"	8'	400810 \$332.69	400811 \$365.97
42"	10'	400925 \$415.86	400926 \$457.46

Square Composite Baluster Kits - STAIR 29°- 41°

Height	Length	White	Black
36"	6'	400804 \$216.97	400805 \$238.67
36"	8'	400806 \$289.31	400807 \$318.23
42"	6'	400812 \$249.52	400813 \$274.48
42"	8'	400814 \$332.69	400815 \$365.97



KIT INCLUDES:

- Top Rail
- Top Sub-Rail
- Bottom Rail
- Round Aluminum Balusters
- Rail Support
- Mounting Brackets w/Screws

Posts, Caps and Trim Sold Separately

*** INSTALLATION HEIGHT FOR**
36" RAIL = 38 - 1/8"
42" RAIL = 42 - 1/8"

RECOMMENDED POST LENGTH PURCHASE

36" w/Aluminum Balusters = 48"
 42" w/Aluminum Balusters = 48"

Bottom of stair posts will require additional post length to cover riser - typical 7" - 8"

PLEASE NOTE: When mixing glass with aluminum balusters overall finish rail height will vary requiring the purchase of 42" square baluster kits.



Round Aluminum Baluster Kits - LEVEL

Height	Length	White	Black
36"	6'	400816(B) \$255.19	400817(B) \$280.72
36"	8'	400818(B) \$340.26	400819(B) \$374.29
36"	10'	400928(B) \$425.32	400929(B) \$467.87
42"	6'	400824(B) \$293.49	400825(B) \$322.83
42"	8'	400826(B) \$391.30	400827(B) \$430.44
42"	10'	400931(B) \$489.15	400932(B) \$538.05

Round Aluminum Baluster Kits - STAIR 30°- 37°

Height	Length	White	Black
36"*	6'	400820(B) \$255.19	400821(B) \$280.72
36"*	8'	400822(B) \$340.26	400823(B) \$374.29
42"*	6'	400828(B) \$293.49	400829(B) \$322.83
42"*	8'	400830(B) \$391.30	400831(B) \$430.44

Round Aluminum Baluster Kits ship with black balusters. To receive balusters in the color of your choice, replace (B) in item number with the color letter shown.

-  **Bronze (Z)**
-  **Hammered Bronze - (H)**
-  **Clay (C)**
-  **Rust (R)**
-  **Green (G)**
-  **White (W)**

CP310 Composite Railing Kits



KIT INCLUDES:

- Top Rail
- Top Sub-Rail
- Bottom Rail
- Rail Support
- Mounting Brackets w/Screws

Posts, Caps, Trim and Horizontal Cable Components Sold Separately

Cable Infill Rail Kits - LEVEL

Height	Length	White	Black
36" & 42"	6'	201800 \$150.01	201801 \$165.01
36" & 42"	8'	201803 \$221.65	201804 \$243.82

Cable Infill Rail Kits - STAIR

Height	Length	White	Black
36" & 42"	6'	201812 \$150.01	201813 \$165.01
36" & 42"	8'	201815 \$221.65	201816 \$243.82

SEE PAGES 143 & 144 FOR ALL HORIZONTAL CABLE COMPONENTS AND ACCESSORIES NOT INCLUDED IN KIT.



KIT INCLUDES:

- Top Rail
- Top Sub-Rail
- Bottom Rail
- 4" Tempered Glass Slats and Glass Baluster Shoes
- Rail Support
- Mounting Brackets w/Screws

Posts, Caps and Trim Sold Separately

*** INSTALLATION HEIGHT FOR
36" RAIL = 38 - 7/8"
42" RAIL = 42 - 7/8"**

4" Glass Slat Kits - LEVEL

Height	Length	White	Black
36"	6'	400832 \$447.85	400833 \$492.63
36"	8'	400834 \$597.14	400835 \$656.85
42"	6'	400840 \$515.03	400841 \$566.53
42"	8'	400842 \$686.71	400843 \$755.37

4" Glass Slat Kits - STAIR 30°- 34°

Height	Length	White	Black
36"*	6'	400836 \$447.85	400837 \$492.63
36"*	8'	400838 \$597.14	400839 \$656.85
42"*	6'	400844 \$515.03	400845 \$566.53
42"*	8'	400846 \$686.71	400847 \$755.37

RECOMMENDED POST LENGTH PURCHASE

36" w/Glass Balusters = 48"
42" w/Glass Balusters = 48"

Bottom of stair posts will require additional post length to cover riser - typical 7" - 8"

PLEASE NOTE: When mixing glass with aluminum balusters overall finish rail height will vary requiring the purchase of 42" square baluster kits.

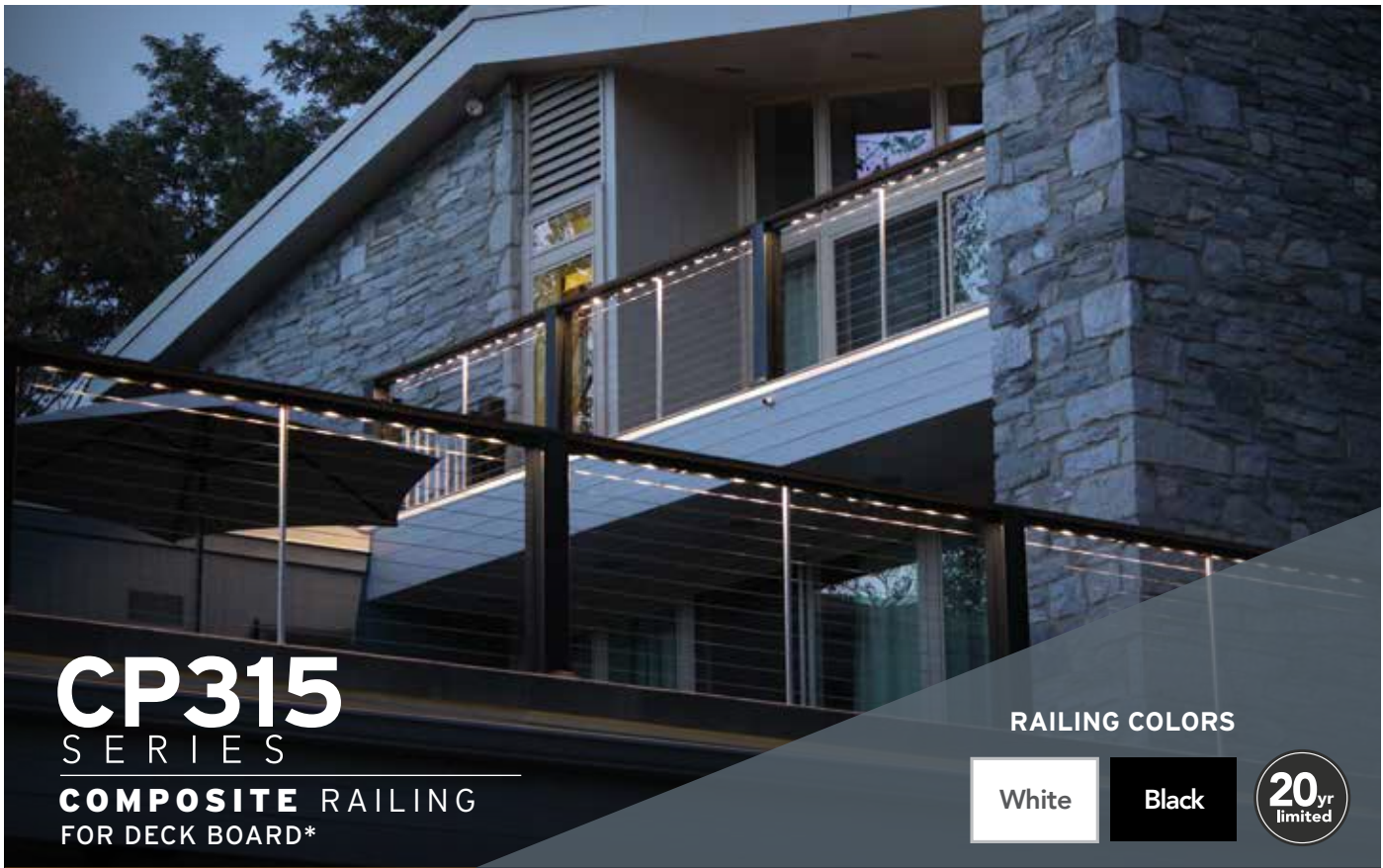

CP315 SERIES

**COMPOSITE RAILING
FOR DECK BOARD***

RAILING COLORS

White

Black



FEATURES & BENEFITS

- Engineered With A Proprietary Crosspolymer Material For Superior Core Properties
- Durable & Fade Resistant - Withstands Extreme Weather Conditions
- Distinct, Classic Profile - Won't Compromise Your View
- Low-Maintenance - No Painting, Sealing Or Staining
- Dimensionally Stable - Won't Twist, Rot Or Splinter
- Environmentally Friendly - Made From Recycled Materials
- Hidden Hardware With Concealed Fasteners
- Two-Piece Top Rail - Ideal For In-Rail LED Lighting
- Coordinate Your Design By Installing Your Preferred Deck Board As A Cap Rail

INFILL OPTIONS

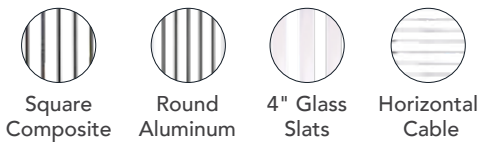

Square Composite

Round Aluminum

4" Glass Slats

Horizontal Cable

RAILING HEIGHTS

36" Residential • 42" Commercial
Meets IRC, IBC Standards

RAILING LENGTHS

6', 8', 10'* Level • 6', 8' Stair

**Length Not Available In Glass Slats*

KITS INCLUDE*

Top Rail, Sub-Rail & Bottom Rails,
Balusters/Infill, Mounting Brackets
& Hardware

**Deck Board Not Included In Kits*

20-Year Limited Warranty

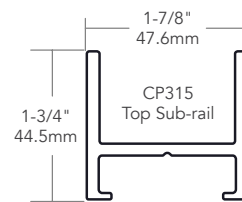

Top
Sub-rail

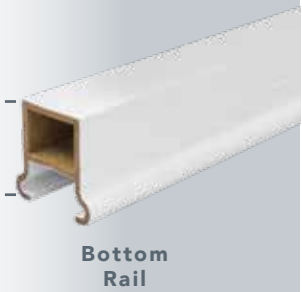
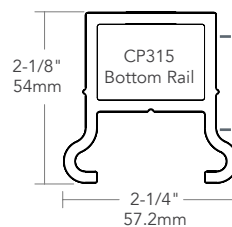

Bottom
Rail

CP315 Composite Railing Kits For Deck Board* Cap Rail



KIT INCLUDES*:

- Sub-Rail
- Bottom Rail
- Square Composite Balusters
- Rail Support
- Mounting Brackets w/Screws

*Deck Board Not Included

Posts, Caps and Trim Sold Separately

Square Composite Baluster Kits - LEVEL

Height	Length	White	Black
36"	6'	401500 \$214.90	401508 \$236.40
36"	8'	401501 \$286.55	401509 \$315.20
42"	6'	401512 \$247.14	401520 \$271.86
42"	8'	401513 \$329.53	401521 \$362.48

Square Composite Baluster Kits - STAIR 29°- 41°

Height	Length	White	Black
36"	6'	401502 \$214.90	401510 \$236.40
36"	8'	401503 \$286.55	401511 \$315.20
42"	6'	401514 \$247.14	401522 \$271.86
42"	8'	401515 \$329.53	401523 \$362.48



KIT INCLUDES*:

- Sub-Rail
- Bottom Rail
- Round Aluminum Balusters
- Rail Support
- Mounting Brackets w/Screws
- Deckboard Mounting Brackets w/Screws

*Deck Board Not Included

Post, Caps and Trim Sold Separately

RECOMMENDED POST LENGTH PURCHASE
 36" w/Aluminum Balusters = 48"
 42" w/Aluminum Balusters = 48"

Bottom of stair posts will require additional post length to cover riser - typical 7" - 8"

Round Aluminum Baluster Kits* - LEVEL

Height	Length	White	Black
36"	6'	401524(B) \$252.76	401532(B) \$278.05
36"	8'	401525(B) \$337.02	401533(B) \$370.73
42"	6'	401536(B) \$290.69	401544(B) \$319.75
42"	8'	401537(B) \$387.58	401545(B) \$426.34

Round Aluminum Baluster Kits* - STAIR 30°- 37°

Height	Length	White	Black
36"	6'	401526(B) \$252.76	401534(B) \$278.05
36"	8'	401527(B) \$337.02	401535(B) \$370.73
42"	6'	401538(B) \$290.69	401546(B) \$319.75
42"	8'	401539(B) \$387.58	401547(B) \$426.34

Round Aluminum Baluster Kits ship with black balusters. To receive balusters in the color of your choice, replace (B) in item number with the color letter shown.

 Bronze (Z)	 Hammered Bronze - (H)	 Clay (C)	 Rust (R)	 Green (G)	 White (W)
---	--	---	---	--	--

PLEASE NOTE: When mixing glass with aluminum balusters overall finish rail height will vary requiring the purchase of 42" square baluster kits.

CP315 Composite Railing Kits For Deck Board* Cap Rail



KIT INCLUDES*:

- Sub-Rail
- Bottom Rail
- 4" Tempered Glass Slats and Glass Baluster Shoes
- Rail Support
- Mounting Brackets w/Screws
- Deckboard Mounting Brackets w/Screws

*Deck Board Not Included

Post, Caps and Trim Sold Separately

RECOMMENDED POST LENGTH PURCHASE

36" w/Glass Balusters = 48"
 42" w/Glass Balusters = 48"

Bottom of stair posts will require additional post length to cover riser - typical 7" - 8"

PLEASE NOTE: When mixing glass with aluminum balusters overall finish rail height will vary requiring the purchase of 42" square baluster kits.

4" Glass Slats* - LEVEL

Height	Length	White	Black
36"	6'	401548 \$443.58	401556 \$487.94
36"	8'	401549 \$591.45	401557 \$650.59
42"	6'	401560 \$510.13	401568 \$561.14
42"	8'	401561 \$680.17	401569 \$748.18

4" Glass Slats Kits* - STAIR 30°- 34°

Height	Length	White	Black
36"	6'	401550 \$443.58	401558 \$487.94
36"	8'	401551 \$591.45	401559 \$650.59
42"	6'	401562 \$510.13	401570 \$561.14
42"	8'	401563 \$680.17	401571 \$748.18



KIT INCLUDES*:

- Sub-Rail
- Bottom Rail
- Rail Support
- Mounting Brackets w/Screws
- Deckboard Mounting Brackets w/Screws

*Deck Board Not Included

Posts, Caps, Trim and Horizontal Cable Infill Sold Separately

Cable Infill Rail Kits* - LEVEL

Height	Length	White	Black
36" & 42"	6'	201806 \$150.01	201807 \$165.01
36" & 42"	8'	201809 \$221.65	201810 \$243.82

Cable Infill Rail Kits* - STAIR

Height	Length	White	Black
36" & 42"	6'	201818 \$150.01	201819 \$165.01
36" & 42"	8'	201821 \$221.65	201822 \$243.82

SEE PAGES 143 & 144 FOR ALL HORIZONTAL CABLE COMPONENTS AND ACCESSORIES NOT INCLUDED IN KIT.

CP300 SERIES

COMPOSITE RAILING
RAILING ACCESSORIES

126 COMPOSITE GATES & ACCESSORIES

127 COMPOSITE POST SLEEVES & ACCESSORIES

128 STRUCTURAL POST MOUNTS

129 COMPOSITE POST CAPS, TRIM, & RAILING

130 COMPOSITE REPLACEMENT COMPONENTS



CP300 Composite Gates & Accessories



Square



Round

Railing Gates

Item Description	White	Black
34" w x 36" h Square Composite Balusters Railing Gate Fully Assembled & Includes: 2 - adjustable self-closing hinges & screws 1 - lockable latch	401194 \$548.22	401195 \$603.04
34" w x 36" h Round Aluminum Balusters Railing Gate Fully Assembled and Includes: 2 - adjustable self-closing hinge & screws 1 - lockable latch All balusters are black aluminum, other aluminum baluster colors are available as a "Special Order"	401197 \$548.22	401198 \$603.04

GATE TIP: Add 1-1/2" to the published gate width for a perfect fit. Custom gates available, maximum rough opening = 42"

A
Top Pull Model

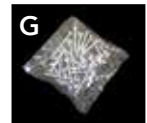

Gate Accessories

Item Description	Black
A - Magna Latch Top Pull Safety Gate Latch	905100 \$138.16
B - External Access Kit Lockable push button operates latch from outside the fence.	905103 \$46.73
C - General Purpose Gate Latch Left or Right Hinge	905102 \$61.93
D - Gate Handle	905104 \$12.86
E - Gate Hinge (pair) 4" Includes 2 - heavy duty / self closing gate hinges and snap-on trim	905105P \$59.43
F - Gate Drop Rod	901040 \$128.00
G - Screw Packs for Gates	401094 \$7.45

CP300 Composite Post Sleeves & Accessories

A



Composite Railing Accessories

Item Description	White	Black
A - Composite Post Sleeve* 4" x 4" x 39"	903194 \$55.80	903199 \$61.38
A - Composite Post Sleeve* 4" x 4" x 48"	903213 \$68.67	903214 \$75.54
A - Composite Post Sleeve* 4" x 4" x 108"	904017 \$153.97	904024 \$169.37
A - Composite Post Sleeve 5-1/4" x 5-1/4" x 39"	400848 \$62.07	400849 \$68.27
A - Composite Post Sleeve 5-1/4" x 5-1/4" x 48"	400850 \$82.75	400851 \$91.03
A - Composite Post Sleeve 5-1/4" x 5-1/4" x 108"	400852 \$157.75	400853 \$173.52

B



Composite Brackets

Item Description	White	Black
B - CP310 Composite Railing Bracket Pack - Level 4 Brackets and Hardware	903004 \$33.20	903005 \$33.20
C - CP310 Composite Railing Bracket Pack - Stair 4 Brackets and Hardware	903006 \$33.20	903007 \$33.20
D* - CP310 Composite Railing Bracket Pack - Angle 4 Brackets and Hardware	903008 \$33.20	903009 \$33.20
E - CP315 Composite Railing Top Brackets	400981 \$47.27	400982 \$47.27
F - CP315 Composite Railing Bracket Screw Pack	901058 \$7.03	901059 \$7.03

C

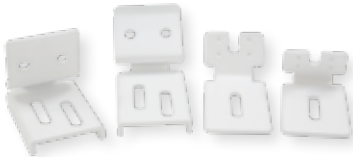

D

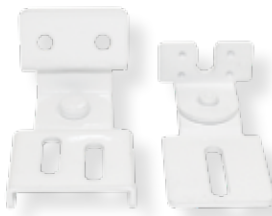

E



F



*When the angle cut of the rail exceeds 22° you will need to use a 5-1/4" post sleeve.

NOTE: Recommended Post Length Purchase

36" CP300 w/Aluminum Baluster = 48"
36" CP300 w/Glass Baluster = 48"

42" CP300 w/Aluminum Baluster = 48"
42" CP300 w/Glass Baluster = 48"

Bottom of stair posts will require additional post length to cover riser - Typical 7" - 8"

CP300 Structural Post Mounts



Installed View:
5-1/4" x 5-1/4" Post Sleeve,
Structural Post Spacer Blocks (2/pk),
Shims, 4" x 4" Structural Post
to fit 5-1/4" x 5-1/4" Post Sleeve

Structural Post Mounts

Description	ITEM
A - 4" x 4" HEAVY-DUTY Structural Post Mount* <ul style="list-style-type: none"> • 1.60" square steel post double welded for maximum strength. Includes leveling flange for all surfaces, four (4) 5/16" x 1 leveling screws and leveling shims for non-level surface mount • Residential/Commercial • Top block can be flipped for 42" railing applications. 	401021A \$134.72
B - 4" x 4" STANDARD Structural Post Mount* <ul style="list-style-type: none"> • 1.60" square steel post includes leveling shims for non-level surface mounting. • Top block can be flipped for 42" railing applications. 	401021 \$90.21

Structural Post Mounts Accessories

Description	ITEM
C - 5-1/4" Post Sleeve - Structural Post Mount Spacer Block Slides over structural post mounts - 2 blocks per kit with screws	903187 \$15.72
D - HEAVY-DUTY Structural Post Mount - Deck Mount Kit** <ul style="list-style-type: none"> • Kit Includes: One (1) 4-hole top mounting plate, one (1) 8-hole bottom mounting plate, four (4) 3/8" x 6" mounting bolts, eight (8) 3/8" washers, eight (8) 3/8" nuts and four (4) 5/16" x 1" leveling screws. • Requires the use of a post trim ring to cover top mounting plate. 	401053 \$30.32
E - Joist Bracket for Standard Structural Post Mounts	401002A \$57.00

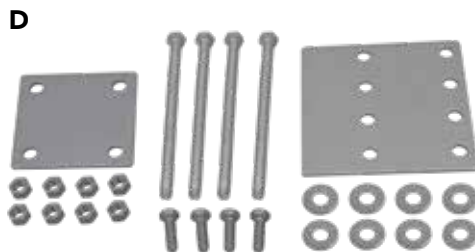

* (A) 4" x 4" HEAVY-DUTY Structural Post Mount and (B) 4" x 4" structural post mounts are coated with a heavy duty, two-layer protective textured finish designed and tested to resist corrosion in exterior applications.

** All components of the FAIRWAY® Structural Post Mount - Deck Mount Kit are coated with a three layer (metallic zinc layer, high-grade anti-corrosion chemical conversion film and baked ceramic surface coating), heavy-duty, high-grade metal surface processing technology that resists corrosion in exterior applications.

CP300 Composite Post Caps, Trim, & Railing

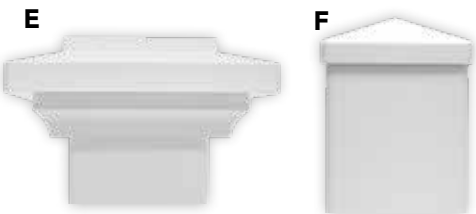
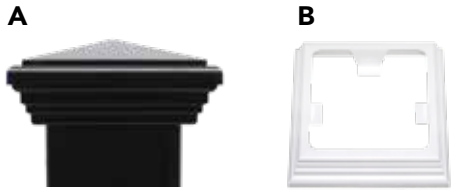

CP300 Composite Top Rail



CP300 Composite Top Sub-Rail



CP300 Composite Bottom Rail

Composite Railing Accessories - Caps & Trim

Item Description	White	Black
A - 4" Classic Post Cap	903200 \$11.04	903205 \$13.25
A - 5-1/4" Classic Post Cap	903000 \$14.24	903001 \$17.09
B - 4" Classic Post Trim	903206 \$7.26	903211 \$8.71
B - 5-1/4" Classic Post Trim	903002 \$7.92	903003 \$9.50
C - 4" Carriage Light Solar Post Cap	901268 \$65.89	901270 \$77.57
C - 5-1/4" Carriage Light Solar Post Cap	901269 \$71.11	901271 \$85.32
D - Universal Post Trim - Sleeve (4 pc.)	902016 \$11.54	903185 \$13.58
E - 4" Harbor Post Cap	901221 \$12.84	901223 \$15.40
E - 5-1/4" Harbor Post Cap	901228 \$15.92	901229 \$19.10
F - 4" External Pyramid Post Cap	901203 \$3.68	903280 \$4.42

Replacement Composite Rails

Item Description	White	Black
6' Composite Top Rail	903015 \$66.41	903016 \$73.05
6' Composite Top Sub-Rail - Composite Baluster	400854 \$33.20	400855 \$36.52
6' Composite Top Sub-Rail - Aluminum Baluster	400862 \$34.53	400863 \$37.98
6' Composite Top Sub-Rail - Glass Slat	400870 \$34.53	400871 \$37.98
6' Composite Bottom Rail - Composite Baluster	400856 \$50.19	400857 \$55.21
6' Composite Bottom Rail - Aluminum Baluster	400864 \$52.19	400865 \$57.42
6' Composite Bottom Rail - Glass Slat	400872 \$52.19	400873 \$57.42
8' Composite Top Rail	903019 \$88.55	903020 \$97.40
8' Composite Top Sub-Rail - Composite Baluster	400858 \$44.28	400859 \$48.69
8' Composite Top Sub-Rail - Aluminum Baluster	400866 \$46.05	400867 \$50.64
8' Composite Top Sub-Rail - Glass Slat	400874 \$46.05	400875 \$50.64
8' Composite Bottom Rail - Composite Baluster	400860 \$66.92	400861 \$73.61
8' Composite Bottom Rail - Aluminum Baluster	400868 \$69.60	400869 \$76.56
8' Composite Bottom Rail - Glass Slat	400876 \$69.60	400877 \$76.56

CP300 Composite Replacement Components



1-1/4" X 1-1/4" CP300 Composite Baluster



Clear Tempered Glass Slats

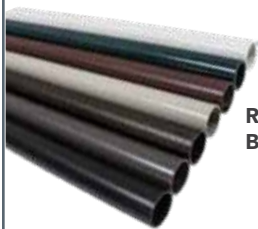

Round Aluminum Balusters

Baluster Colors



B Z H C R G W

Replacement Baluster Connectors & Shoes

Item Description	White	Black
A - Baluster Pin Grip Connector Level (14/pk.)	903260 \$7.43	N/A
A - Baluster Pin Grip Connector Level (19/pk.)	903261 \$10.12	N/A
B - Round Aluminum Baluster Connector Level (20/pk.)	N/A	301374 \$9.35
C - Round Aluminum Baluster Connector Stair (20/pk.)	N/A	301380 \$12.13
D - Glass Baluster Connector Shoe Level (2/pk.)	301381W \$13.80	301381 \$13.80
E - Glass Baluster Connector Shoe Stair (2/pk.)	301387W \$15.19	301387 \$15.19

Replacement Balusters

Item Description	White	Black
1-1/4" x 1-1/4" x 30" Composite Baluster (36" Railing)	903011 \$12.61	903012 \$13.87
1-1/4" x 1-1/4" x 36" Composite Baluster (42" Railing)	903013 \$15.77	903014 \$17.34

Replacement Rail Supports

Item Description	White	Black
5" Composite Rail Support - Level	903146 \$9.05	903150 \$9.96
7" Composite Rail Support - Stair	903300 \$9.05	903304 \$9.96

Replacement Glass Slats*

Item Description	Clear
4" x 5/16" x 32" Clear Tempered Glass Slats - Level	301372 \$15.86/ea.
4" x 5/16" x 38" Clear Tempered Glass Slats - Level	301373 \$18.59/ea.
4" x 5/16" x 32-1/4" Clear Tempered Glass Slats - Stair	301384 \$17.22/ea.
4" x 5/16" x 40" Clear Tempered Glass Slats - Stair	301386 \$19.74/ea.

Replacement Round Aluminum Balusters

Item Description	Black (B)	Bronze (Z)	Hammered Bronze (H)	Clay (C)	Rust (R)	Green (G)	White (W)
32" Round Aluminum Baluster (1pc.)	301416 \$3.40	301418 \$3.52	301427 \$3.52	301420 \$3.52	301424 \$3.52	301422 \$3.52	301426 \$3.52
36" Round Aluminum Baluster (1pc.)	301440 \$3.88	301442 \$4.01	301443 \$4.01	301444 \$4.01	301448 \$4.01	301446 \$4.01	301450 \$4.01

***PRICE SHOWN IS FOR ONE (1) GLASS SLAT, HOWEVER SLATS ARE ONLY SOLD IN PACKS OF FIVE (5). "EACH" PRICE X 5 = YOUR COST.**



HORIZONTAL CABLE RAILING SYSTEM

FAIRWAY HORIZONTAL CABLE SYSTEM - [Simplifies From Design To Installation](#)

- Proprietary structural post with pre-spaced riv-nuts to ensure even spacing and faster installation
- Pass-through post designed for level and stair applications
- Pre-drilled line, corner or end post sleeves for rapid and even installation
- Pre-drilled intermediate baluster designed for level and stair applications - available in black and anodized
- 100% right hand fitting operation
- No angle drilling for angle or stair installations



Termination Riv-Nut Post

FAIRWAY PROPRIETARY STRUCTURAL POST WITH RIV-NUTS

- Robust structure that supports proper tension to meet and exceed code requirements
- Pre-spaced and pre-drilled riv-nuts assures even spacing and faster installation
- Includes leveling flange kit for all surfaces, even concrete
- Post design accommodates either end, line or corner installations
- Deck mounting kit is available

Works with



Horizontal Cable Installation Pro Tips

A cable railing installation may seem complex to the inexperienced installer. However, when following a few tips and techniques, contractors can ensure a safe and secure installation with Fairway's cable railing system.

Below are a few highlights on how to prevent possible cable wire slippage and other matters of installation.

CUTTING CABLE WIRE

Avoid using tools that are not designed for cutting metal cable wire rope. Hand tools such as a lineman's side cutter will fray or unravel braided cable wire. This can inhibit the locking jaws within the fitting to securely engage the wire and result in cable slippage within the fittings.



Use a metal cable cutting tool to cut cable wire rope.

A metal cable cutter tool is recommended for cable rail installation. This tool is designed to create a round and compact wire cut pattern that will properly engage the locking jaws within the fitting, providing the installer with secure tension.

Metal cable cutting tool specifications:

Steel Wire Rope - up to 5/32"

Stainless Wire Rope - up to 1/8"

Mild Steel Rod - up to 1/8"



Use the "witness line" when cutting the cable wire rope.

At the tensioning fitting, use the witness line as a guide to cut the length of the cable wire.

Do **not** use the line where fittings connect. The length of the cable wire will be too long and you will not be able to secure proper tension.

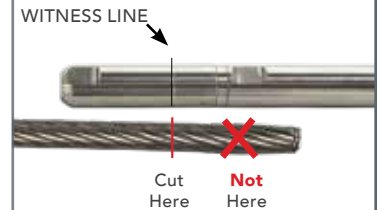

RIV-NUT POST - CABLE FITTING INSTALLATION

Refrain from using an impact drill to install cable fittings.

Do not use an impact drill when installing the machine studs into the riv-nut structural post. The use of an impact drill can cause the riv-nut to break loose and spin inside of the structural post. This will cause a failure in tension across the cable.

Two types of installation methods are recommended:

1. Screwdriver with a 3/16" hex head bit
2. By hand and hand-tighten

Using either method will adequately secure the machine studs allowing you to properly tension the cable.



Machine Stud Fittings - Insert "stop" side into riv-nut post.

Install the "stop" side of the machine stud fitting into the riv-nut post.



Horizontal Cable Installation Pro Tips

RIV-NUT POST - CABLE FITTING INSTALLATION (Continued)

Cable Rail Fittings - Cover only half of the machine stud threads.

When installing cable rail fittings, hand thread the fitting (3-4 turns) leaving half of the thread exposed on the machine stud. This will allow for travel between fittings resulting in proper tension.

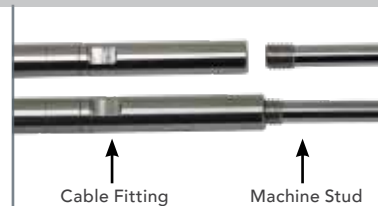

Stair Clevis Fittings - "Broad" end attaches to riv-nut post.

Install the "broad" end of the stair clevis fitting into the riv-nut to allow for proper tension.



WOOD POST - CABLE FITTING INSTALLATION

Pre-drill wood post

Pre-drill wood post using a 1/4" drill bit, before installing lag screws into posts.

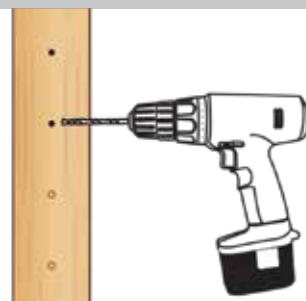

Refrain from using an impact drill to install lag screws.

Do not use an impact drill when installing the lag screws into the wood post.

Two types of installation methods are recommended:

1. Screwdriver with a 3/16" hex head bit
2. Non-Impact Drill with a 3/16" hex head bit

Using either method will adequately secure the lag screws and allow you to properly tension the cable.



Lag Screws - Insert until threads are no longer visible.

When installing lag screws into wood post, insert until screw threads are no longer visible.

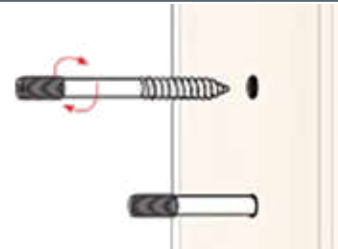

Cable Rail Fittings - Cover only half of the lag screw threads.

When installing cable rail fittings, hand thread the fitting (3-4 turns) leaving half of the thread exposed on the lag screw. This will allow for travel between fittings resulting in proper tension.



Horizontal Cable Installation Pro Tips

CABLE WIRE

Not all cable wire is created equal.

Where a 3/16" cable would appear to easily fit into the opening of the cable fittings, the locking jaws within the fittings are specially designed for 1/8" cable wire. Anything over 1/8" diameter will not allow the jaws to open or close properly, resulting in a bundled wire or cable slippage within the fittings.



Avoid using "right hand lay" cable wire.

Fairway's cable rail fittings are designed to respond to "left hand lay" wire. The use of "right hand lay" cable wire will cause fraying or unbraiding of the cable wire, resulting in a bundled wire or cable slippage within the fittings.



Avoid transfer of tool lubricant or cleaning solution onto cable wire.

Cleaning or lubricating tools is customary; however, it is extremely important to make sure to remove any remaining residue. Lubricants can transfer to the cable wire and create slippage within the fittings.



POST & RAIL INSTALLATION

RIV-NUT POST - Install a cable fitting in the top and bottom row of each post.

Once you've installed the structural posts and sleeves, install a cable wire fitting in the top and bottom row, **before** attaching your top and bottom rail brackets to each post.

This will allow you to align the post sleeve pre-routed holes with the structural post holes and accurately position the cable fittings to ensure proper tension.

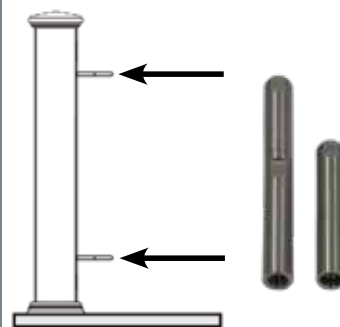

WOOD POST/ NO SLEEVE – Use a pre-drilled vinyl sleeve or intermediate baluster as a drill template.

When using a wood post without a sleeve, cable fitting patterns can be achieved by simply sliding a pre-drilled vinyl sleeve over the wood post or by using an intermediate baluster and marking the hole pattern. Either technique can be used to mark end, line or corner wood posts.

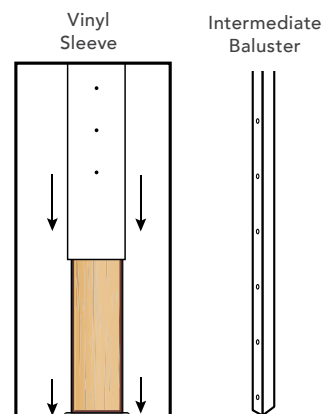

Horizontal Cable Installation Pro Tips

POST & RAIL INSTALLATION (Continued)

Rail installation should always include a bottom rail.

Our cable rail system is designed for a top and bottom rail with 9 rows of cable wire for a 36" high system. Bottom rails play an important part in the stability of the railing as they add support and allow for a foot rest when leaning against the railing.

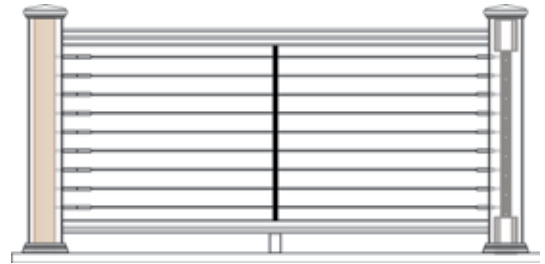

CABLE WIRE INSERTION

Avoid inserting cable wire at an angle.

Our fittings are designed with a spring-loaded jaw which automatically locks the cable into place when the wire is inserted on center. In the event the wire is installed at an angle, the braiding can get caught on the outside of the jaws and not lock into place.

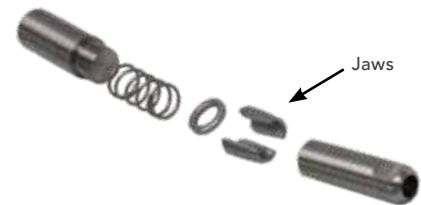

To easily insert the cable wire into the tensioning and non-tensioning fittings, use the cable install tool as part of the three-step process.

Step 1

Once the tensioning and non-tensioning cable fittings are installed, carefully insert the cable install tool into lockjaw fitting and push down until the tool bottoms out. If done correctly, you will feel resistance from the spring-loaded jaws.

Step 1



Step 2

Insert the cable wire into the fitting "on center" until you hear the cable "click" (lock) into place.

Step 2



Step 3

Once cable wire is inserted, remove the cable install tool from fitting and pull slightly on the cable wire to ensure proper wire engagement within the fitting. This final step will provide you with the resistance needed to secure proper tension.

Step 3



P300 Series Cellular PVC Horizontal Cable Kits



KIT INCLUDES:

- Top Rail w/Aluminum Insert
- Top Sub-Rail
- Bottom Rail w/ Aluminum Insert
- Rail Support
- Mounting Brackets w/Screws

P310 - Cable Infill Rail Kits - LEVEL

Height	Length	White
36" & 42"	6'	202000 \$144.24
36" & 42"	8'	202010 \$213.13

P310 - Cable Infill Rail Kits - STAIR

Height	Length	White
36" & 42"	6'	202005 \$144.24
36" & 42"	8'	202015 \$213.13

POSTS, CAPS, TRIM, AND HORIZONTAL CABLE COMPONENTS SOLD SEPARATELY. SEE PAGES 18, 143 & 144.



KIT INCLUDES*:

- Top Rail w/ Aluminum Insert
- Top Sub-Rail
- Bottom Rail w/ Aluminum Insert
- Rail Support
- Mounting Brackets w/Screws

*Deck Board Not Included

P315 - Cable Infill Rail Kits* - LEVEL

Height	Length	White
36" & 42"	6'	202025 \$144.24
36" & 42"	8'	202035 \$213.13

P315 - Cable Infill Rail Kits*- Stair

Height	Length	White
36" & 42"	6'	202030 \$144.24
36" & 42"	8'	202040 \$213.13

POSTS, CAPS, TRIM, AND HORIZONTAL CABLE COMPONENTS SOLD SEPARATELY. SEE PAGES 18, 143 & 144.

Pre-Drilled P300 Post Sleeves for Cable Railing - LEVEL

Item Description	White
P300 White 4-1/4" x 4-1/4" x 39" Cable Line Post Sleeve	201900 \$54.23
P300 White 4-1/4" x 4-1/4" x 39" Cable Corner Post Sleeve	201905 \$54.23
P300 White 4-1/4" x 4-1/4" x 39" Cable End Post Sleeve	201910 \$54.23
P300 White 4-1/4" x 4-1/4" x 48" Cable Line Post Sleeve	201915 \$66.62
P300 White 4-1/4" x 4-1/4" x 48" Cable Corner Post Sleeve	201920 \$66.62
P300 White 4-1/4" x 4-1/4" x 48" Cable End Post Sleeve	201925 \$66.62

Cellular PVC Railing Accessories - Cap & Trim

Item Description	White
A - 4.25" x 4.25" Classic Post Cap	500070 \$11.49
B - 4.25" x 4.25" Classic Post Trim	500071 \$9.65



For Additional Caps, Trim & Brackets, See page 18

A200 Series Aluminum Horizontal Cable Kits



A210 - Cable Infill Rail Kits - LEVEL

Height	Length	Matte White	Textured Bronze	Textured Black
36" & 42"	6'	201620 \$111.14	201621 \$111.14	201622 \$111.14
36" & 42"	8'	201623 \$136.83	201624 \$136.83	201625 \$136.83

A210 - Cable Infill Rail Kits - STAIR

Height	Length	Matte White	Textured Bronze	Textured Black
36" & 42"	6'	201626 \$121.70	201627 \$121.70	201628 \$121.70
36" & 42"	8'	201629 \$149.83	201630 \$149.83	201631 \$149.83

KIT INCLUDES:

- Top Rail
- Sub-rail
- Bottom Rail
- Mounting Brackets w/ Screws
- Rail Support

Installation template included in level kits.

POSTS, CAPS, TRIM, AND HORIZONTAL CABLE COMPONENTS SOLD SEPARATELY. SEE PAGES 37, 143 & 144.

A210 - Pre-Drilled Post Sleeves for Cable Railing - LEVEL

Item Description	Matte White	Textured Bronze	Textured Black
4" x 4" x 39" Cable Post Sleeve - Line	201520 \$58.00	201523 \$58.00	201526 \$58.00
4" x 4" x 39" Cable Post Sleeve - Corner	201521 \$58.00	201524 \$58.00	201527 \$58.00
4" x 4" x 39" Cable Post Sleeve - End	201522 \$58.00	201525 \$58.00	201528 \$58.00
4" x 4" x 44" Cable Post Sleeve - Line	201530 \$71.87	201533 \$71.87	201536 \$71.87
4" x 4" x 44" Cable Post Sleeve - Corner	201531 \$71.87	201534 \$71.87	201537 \$71.87
4" x 4" x 44" Cable Post Sleeve - End	201532 \$71.87	201535 \$71.87	201538 \$71.87



A210 Railing Accessories - Cap & Trim

Item Description	Matte White	Textured Bronze	Textured Black
4" Post Cap	306173 \$10.37	306176 \$10.37	306171 \$10.37
4" Post Base Trim - 2 pc	306163 \$12.56	306164 \$12.56	306161 \$12.56

A210 Railing Accessories - Brackets

PTP Top Rail Bracket - Multi-Angle Level (1/pk)	306142 \$33.93	306145 \$33.93	306140 \$33.93
Bottom Rail Bracket - Multi-Angle Level (1/pk)	306152 \$26.73	306155 \$26.73	306150 \$26.73

For Additional Caps, Trim & Brackets, See pages 37

A300 Series Aluminum Horizontal Cable Kits

KIT INCLUDES:

- Top Rail
- Bottom Rail
- Mounting Brackets w/Screws
- Rail Support - Surface Mount

A310 - Cable Infill Rail Kits - LEVEL

Height	Length	White	Bronze	Black
36" & 42"	6'	201600 \$111.14	201601 \$111.14	201602 \$111.14
36" & 42"	8'	201603 \$136.83	201604 \$136.83	201605 \$136.83

A310 - Cable Infill Rail Kits - STAIR

Height	Length	White	Bronze	Black
36" & 42"	6'	201610 \$121.70	201611 \$121.70	201612 \$121.70
36" & 42"	8'	201613 \$149.83	201614 \$149.83	201615 \$149.83

POSTS, CAPS, TRIM, AND HORIZONTAL CABLE COMPONENTS SOLD SEPARATELY. SEE PAGES 52, 53, 143 & 144.

A310 - Pre-Drilled Aluminum Post Sleeves for Cable Railing - LEVEL

Item Description	White	Bronze	Black
4" x 4" x 39" Aluminum Post Sleeve for Cable Rail - Line	201500 \$58.00	201506 \$58.00	201503 \$58.00
4" x 4" x 39" Aluminum Post Sleeve for Cable Rail - Corner	201501 \$58.00	201507 \$58.00	201504 \$58.00
4" x 4" x 39" Aluminum Post Sleeve for Cable Rail - End	201502 \$58.00	201508 \$58.00	201505 \$58.00
4" x 4" x 44" Aluminum Post Sleeve for Cable Rail - Line	201509 \$71.87	201515 \$71.87	201512 \$71.87
4" x 4" x 44" Aluminum Post Sleeve for Cable Rail - Corner	201510 \$71.87	201516 \$71.87	201513 \$71.87
4" x 4" x 44" Aluminum Post Sleeve for Cable Rail - End	201511 \$71.87	201517 \$71.87	201514 \$71.87

A310 Railing Accessories - Cap & Trim

Item Description	White	Bronze	Black
4" Post Cap	300641 \$9.85	300646 \$9.85	300636 \$9.85
4" Post Base Trim - 2 pc	300536 \$17.85	300541 \$17.85	300531 \$17.85

A310 Railing Accessories - Brackets

Bottom Rail Bracket (PTP/OTP) Multi-Angle Level (1/pk)	300565 \$26.73	300570 \$26.73	300560 \$26.73
Top Rail Bracket (PTP) Fixed-Pitch Stair 30°-34° (2pk)	300444 \$23.60	300446 \$23.60	300439 \$23.60

For Additional Caps, Trim & Brackets, See page 52-53



V100 & V200 Series Vinyl Horizontal Cable Kits



V110

V110 - Cable Infill Rail Kits - LEVEL

Height	Length	White	Almond	Khaki
36" & 42"	6'	201300 \$101.52	230006 \$116.75	201301 \$121.82
36" & 42"	8'	201302 \$129.96	230007 \$149.45	201303 \$155.95

V110 - Cable Infill Rail Kits - STAIR

Height	Length	White	Almond	Khaki
36" & 42"	6'	201310 \$111.16	230008 \$127.83	201311 \$133.40
36" & 42"	8'	201312 \$142.31	230009 \$163.66	201313 \$170.77

KIT INCLUDES:

- Vinyl Top Rail
- Vinyl Bottom Rail
- Rail Support (Level)
- Aluminum Inserts (Top, Bottom Rail)
- Mounting Brackets w/Screws

POSTS, CAPS, TRIM, AND HORIZONTAL CABLE COMPONENTS SOLD SEPARATELY. SEE PAGES 64, 97-101, 143 & 144.



V210

V210 - Cable Infill Rail Kits - LEVEL

Height	Length	White	Almond	Khaki
36" & 42"	6'	201400 \$137.00	230010 \$157.54	201402 \$164.39
36" & 42"	8'	201403 \$180.57	230011 \$207.66	201405 \$216.69

V210 - Cable Infill Rail Kits - STAIR

Height	Length	White	Almond	Khaki
36" & 42"	6'	201418 \$150.01	230016 \$172.51	201420 \$180.01
36" & 42"	8'	201421 \$197.73	230017 \$227.39	201423 \$237.27

KIT INCLUDES:

- Vinyl Top Rail
- Vinyl Bottom Rail
- Aluminum Inserts (Top, Bottom Rail)
- Mounting Brackets w/Screws

POSTS, CAPS, TRIM, AND HORIZONTAL CABLE COMPONENTS SOLD SEPARATELY. SEE PAGES 97-101, 143 & 144.



Black Carriage LED Light Post Cap

Vinyl Railing Accessories - Cap & Trim

Item Description	White	Almond	Khaki
Classic Post Cap 4"	401048 \$11.26	430201 \$12.94	406048 \$13.51
External Pyramid Post Cap 4"	901203 \$3.68	430203 \$4.23	406221 \$4.25
New England Post Cap 4"	901220 \$8.36	430206 \$10.03	904042 \$10.03
Classic Post Trim 4"	900350 \$7.26	430202 \$8.35	406210 \$8.71
New England Post Trim 4"	901225 \$7.49	430207 \$8.61	904046 \$8.99

For Additional Caps, Trim & Brackets, See page 64-65, 73, 98

V100 & V200 Series Vinyl Horizontal Cable Kits



V215

KIT INCLUDES*:

- Vinyl Top Rail
- Vinyl Bottom Rail
- Aluminum Inserts (Top, Bottom Rail)
- Mounting Brackets w/Screws
- Deck Board Mounting Plates w/Screws

*Deck Board not Included

V215 - Cable Rail Infill Kits* - LEVEL

Height	Length	White	Almond	Khaki
36" & 42"	6'	201412 \$137.00	230014 \$157.54	201414 \$164.39
36" & 42"	8'	201415 \$180.57	230015 \$207.66	201417 \$216.69

V215 - Cable Rail Infill Kits* - STAIR

Height	Length	White	Almond	Khaki
36" & 42"	6'	201430 \$150.01	230020 \$172.51	201432 \$180.01
36" & 42"	8'	201433 \$197.73	230021 \$227.39	201435 \$237.27

**POSTS, CAPS, TRIM, AND HORIZONTAL CABLE COMPONENTS
SOLD SEPARATELY. SEE PAGES 97-101, 143 & 144.**



V220

KIT INCLUDES:

- Vinyl Top Rail
- Vinyl Bottom Rail
- Aluminum Inserts (Top, Bottom Rail)
- Mounting Brackets w/Screws

V220 - Cable Rail Infill Kits - LEVEL

Height	Length	White	Almond	Khaki
36" & 42"	6'	201406 \$137.55	230012 \$158.18	201408 \$165.06
36" & 42"	8'	201409 \$184.60	230013 \$212.29	201411 \$221.52

V220 - Cable Rail Infill Kits - STAIR

Height	Length	White	Almond	Khaki
36" & 42"	6'	201424 \$150.61	230018 \$173.21	201426 \$180.74
36" & 42"	8'	201427 \$202.13	230019 \$232.45	201429 \$242.56

**POSTS, CAPS, TRIM, AND HORIZONTAL CABLE COMPONENTS
SOLD SEPARATELY. SEE PAGES 97-101, 143 & 144.**

Vinyl Post Sleeves 4"- Pre-Drilled for Cable Railing - LEVEL

Item Description	White	Almond	Khaki
Vinyl Post Sleeve for Cable Rail 4" x 4" x 39" - Line	201200 \$30.56	230000 \$34.52	201206 \$35.87
Vinyl Post Sleeve for Cable Rail 4" x 4" x 39" - Corner	201201 \$30.56	230001 \$34.52	201207 \$35.87
Vinyl Post Sleeve for Cable Rail 4" x 4" x 39" - End	201202 \$30.56	230002 \$34.52	201208 \$35.87
Vinyl Post Sleeve for Cable Rail 4" x 4" x 48" - Line	201209 \$33.24	230003 \$37.72	201215 \$39.22
Vinyl Post Sleeve for Cable Rail 4" x 4" x 48" - Corner	201210 \$33.24	230004 \$37.72	201216 \$39.22
Vinyl Post Sleeve for Cable Rail 4" x 4" x 48" - End	201211 \$33.24	230005 \$37.72	201217 \$39.22

CP300 Series Composite Horizontal Cable Kits



CP310

CP310 - Cable Infill Rail Kits - LEVEL

Height	Length	White	Black
36" & 42"	6'	201800 \$150.01	201801 \$165.01
36" & 42"	8'	201803 \$221.65	201804 \$243.82

CP310 - Cable Infill Rail Kits - STAIR

Height	Length	White	Black
36" & 42"	6'	201812 \$150.01	201813 \$165.01
36" & 42"	8'	201815 \$221.65	201816 \$243.82

KIT INCLUDES:

- Top Rail
- Top Sub-Rail
- Bottom Rail
- Rail Support
- Mounting Brackets w/Screws

POSTS, CAPS, TRIM, AND HORIZONTAL CABLE COMPONENTS SOLD SEPARATELY. SEE PAGES 127, 129, 143 & 144.



CP315

CP315 - Cable Infill Rail Kits* - LEVEL

Height	Length	White	Black
36" & 42"	6'	201806 \$150.01	201807 \$165.01
36" & 42"	8'	201809 \$221.65	201810 \$243.82

CP315 - Cable Infill Rail Kits* - STAIR

Height	Length	White	Black
36" & 42"	6'	201818 \$150.01	201819 \$165.01
36" & 42"	8'	201821 \$221.65	201822 \$243.82

KIT INCLUDES*:

- Top Sub-Rail
- Bottom Rail
- Rail Support
- Mounting Brackets w/Screws
- Deckboard Mounting Brackets w/Screws

*Deck Board Not Included

POSTS, CAPS, TRIM, AND HORIZONTAL CABLE COMPONENTS SOLD SEPARATELY. SEE PAGES 127, 129, 143 & 144.

Composite Railing Accessories - Cap & Trim

Item Description	White	Black
4" Classic Post Cap	903200 \$11.04	903205 \$13.25
4" External Pyramid Post Cap	901203 \$3.68	903280 \$4.42
4" Harbor Post Cap	901221 \$12.84	901223 \$15.40
Universal Post Trim - Sleeve (4 pc.)	902016 \$11.54	903185 \$13.58

For Additional Caps, Trim, & Brackets, See page 127, 129

White Carriage LED Light Post Cap

CP300 Series Composite Horizontal Cable Kits

Pre-Drilled CP300 Composite Post Sleeves for Cable Railing - LEVEL

Item Description	White	Black
Composite Post Sleeve for Cable Rail 4" x 4" x 39" - Line	201700 \$56.39	201703 \$61.71
Composite Post Sleeve for Cable Rail 4" x 4" x 39" - Corner	201701 \$56.39	201704 \$61.71
Composite Post Sleeve for Cable Rail 4" x 4" x 39" - End	201702 \$56.39	201705 \$61.71
Composite Post Sleeve for Cable Rail 4" x 4" x 48" - Line	201709 \$69.29	201712 \$75.82
Composite Post Sleeve for Cable Rail 4" x 4" x 48" - Corner	201710 \$69.29	201713 \$75.82
Composite Post Sleeve for Cable Rail 4" x 4" x 48" - End	201711 \$69.29	201714 \$75.82
Composite Post Sleeve for Cable Rail 5-1/4" x 5-1/4" x 39" - Line	201718 \$64.18	201721 \$70.33
Composite Post Sleeve for Cable Rail 5-1/4" x 5-1/4" x 39" - Corner	201719 \$64.18	201722 \$70.33
Composite Post Sleeve for Cable Rail 5-1/4" x 5-1/4" x 39" - End	201720 \$64.18	201723 \$70.33
Composite Post Sleeve for Cable Rail 5-1/4" x 5-1/4" x 48" - Line	201727 \$84.67	201730 \$92.87
Composite Post Sleeve for Cable Rail 5-1/4" x 5-1/4" x 48" - Corner	201728 \$84.67	201731 \$92.87
Composite Post Sleeve for Cable Rail 5-1/4" x 5-1/4" x 48" - End	201729 \$84.67	201732 \$92.87



CP315 Black with Deck Board and Horizontal Cable Infill

Cable Rail Components

A Cable Rail Fitting • Tensioning



Cable Rail Fitting • Non-Tensioning



B Machine Stud - Level
Use w/ Fairway® Cable Rail Structural Post Mount



C 4" Machine Stud Clevis - Angle or Stair



D 5-1/4" Machine Stud Clevis - Angle or Stair
Use w/ Fairway® Cable Rail Structural Post Mount



E 1-7/8" Machine Stud Clevis - Angle or Stair
Use w/ Fairway® Cable Rail Structural Post Mount



F Lag Screw - Level



G Lag Screw - Level or Stair



H Post Sleeve Protector



I Cable Install Tool



FAIRWAY® Cable rail fittings are conveniently packaged in recyclable jars.



Cable Rail Infill Fittings - Recyclable Jar (18 Fittings Per Jar)

Description	Item	
Post to Post	A - Post to Post Fittings Kit (18 fittings) 9 - Tensioning, 9 - Non-Tensioning Fittings & Cable Install Tool, Lacing Needle	201140 \$543.77
Structural Post	B - Machine Stud - Level Kit (18 fittings)	201122 \$235.81
Structural Post	C - 4" Machine Stud Clevis - Angle or Stair Kit (18 fittings)	201132 \$538.62
Structural Post	D - 5-1/4" Post Sleeve Machine Stud Clevis - Angle or Stair kit (18 fittings)	201134 \$573.41
Structural Post	E - 1-7/8" Post Sleeve Machine Stud Clevis - Angle or Stair kit (18 fittings)	201130 \$538.62
Wood Post	F - Lag Screw - Level Kit (18 fittings)	201102 \$291.86
Wood Post	G - 4" Post Sleeve Lag Screw Clevis - Angle or Stair Kit (18 Fittings)	201112 \$603.05
Wood Post	G - 5-1/4" Post Sleeve Lag Screw Clevis - Angle or Stair Kit (18 Fittings)	201114 \$637.84

Cable Rail Infill Fittings - Single Fittings

Description	Item	
Post to Post	A - Non-Tensioning Fitting	201030B \$27.06
Post to Post	A - Tensioning Fitting	201032B \$48.32
Structural Post	B - Machine Stud - Level	201062B \$20.62
Structural Post	C - 4" Machine Stud Clevis - Angle or Stair	201072B \$41.88
Structural Post	D - 5-1/4" Post Sleeve Machine Stud Clevis - Angle or Stair	201074B \$43.81
Structural Post	E - 1-7/8" Post Sleeve Machine Stud Clevis - Angle or Stair kit	201070B \$41.88
Wood Post	F - Lag Screw - Level	201042B \$20.62
Wood Post	G - 4" Post Sleeve Lag Screw Clevis - Angle or Stair	201052B \$41.88
Wood Post	G - 5-1/4" Post Sleeve Lag Screw Clevis - Angle or Stair	201054B \$43.81
Post Sleeve	H - Post Sleeve Protector (50pcs./pk)	201086 \$78.62
Cable	I - Cable Install Tool	201152 \$13.10

All FAIRWAY® cable rail fittings are 316 stainless steel and right hand thread.

Cable Rail Components

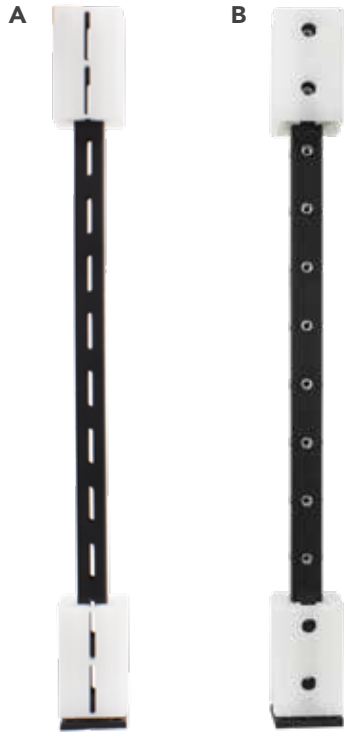

Cable Components

Description	Item
A - Cable Rail Structural Post Mount - Pass Through Post - Level/Stair (3 - 1/8" OC Cable Spacing)	201008 \$144.96
B - Cable Rail Structural Post Mount - Termination Post w/Riv-Nuts (3 - 1/8" OC Cable Spacing)	201003 \$186.47
C - 100' x 1/8" 316 Stainless Steel Cable Coil (Bagged)	201154 \$115.97
D - 500' x 1/8" 316 Stainless Steel Cable Spool (Boxed)	201150 \$579.85
E - Cable Cutting Tool	201084 \$89.98
F - Cable Cleaning Solution	201160 \$75.68

Intermediate Baluster for Level & Stair

Item Description	Black	Anodized
G - Intermediate Baluster for Level & Stair* Includes Baluster Connectors and Fasteners <i>* Intermediate Balusters must be installed no greater than ever 48" between posts.</i>	201145 \$54.53	201149 \$54.54



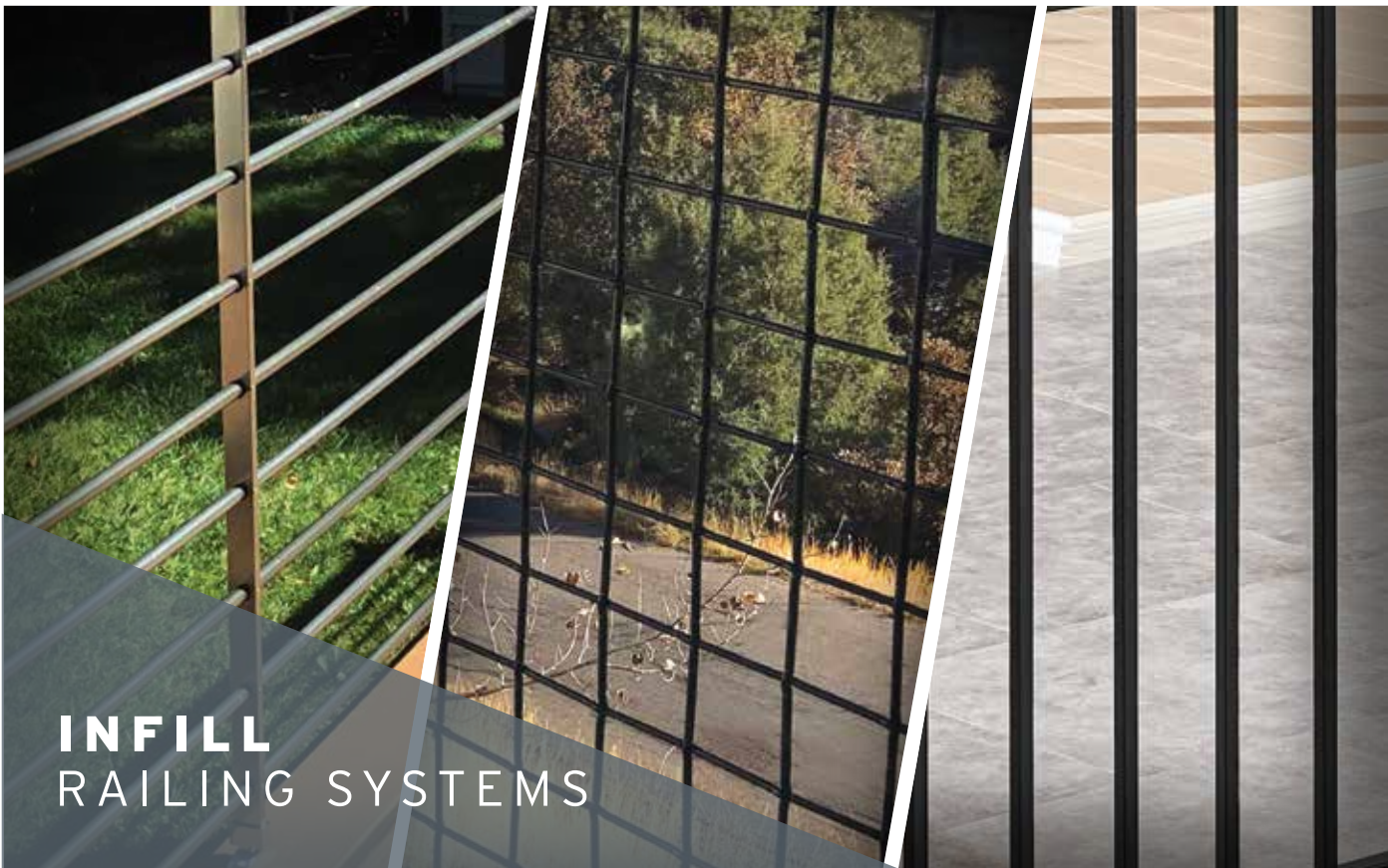

INFILL RAILING SYSTEMS



HORIZONTAL BALUSTER

- Packaged As A Kit - Can Be Used As Infill Between Aluminum, Vinyl, Composite Or Wood
- Balusters Can Be Field Modified To Fit Post Spacing
- Set Screws In Intermediate Baluster Prevent Baluster Rattle
- Line Of Sight Is Continuous From Level To Stair
- Full Post-To-Post Assembly

INFILL LENGTHS

6' & 8' Level • 6' & 8' Stair

INFILL RAILING HEIGHTS

36" • 42"

Meets IRC Standards

AAMA-2604 Compliant Powder Coating

INFILL COLOR



MESH INFILL

- Can Be Used As Infill Between Aluminum, Vinyl, Composite Or Wood
- 0.25" Wire Diameter In A 3" x 3" Woven Panel - Crimp- Locked
- Aluminum Mesh Panels Eliminate Unsightly Rust
- A Clean And Industrial Design Influenced By Leading Architectural Designers

INFILL LENGTHS

Nominal 6' & 8' Level

INFILL RAILING HEIGHTS

36" • 42"

Meets IRC Standards

AAMA-2604 Compliant Powder Coating

INFILL COLOR



STEEL INFILL

- Panel Can Be Used As Infill Between Vinyl, Composite Or Wood
- Safe, Strong And Durable
- Quick And Easy Installation
- Galvanized Steel Powder Coating For Superior Coating Performance

INFILL LENGTHS

70", 94" Level • 70", 94" Stair

INFILL RAILING HEIGHTS

36" • 42"

Meets IRC, IBC Standards

AAMA-2604 Compliant Powder Coating

INFILL COLOR



Horizontal Baluster & Mesh Infill Railing Systems

Horizontal Baluster



KIT INCLUDES:

- 7 Horizontal Balusters & 7 Pairs of Brackets
- 1 Intermediate Baluster & 1 Pair of Brackets
- 1 Horizontal Baluster Installation Tool

Number of Balusters Needed for a Typical Hardwood Installation

36" Rail	42" Rail
• With Bottom Rail - 6	• With Bottom Rail - 8
• W/out Bottom Rail - 7	• W/out Bottom Rail - 9

Horizontal Baluster Infill Kits - LEVEL

Height	Length	Textured Black	Anodized
36" & 42"	6'	203051 \$400.37	203050 \$400.37
36" & 42"	8'	203055 \$533.82	203054 \$533.82

Horizontal Baluster Infill Kits - STAIR

Height	Length	Textured Black	Anodized
36" & 42"	6'	203053 \$551.62	203052 \$551.62
36" & 42"	8'	203057 \$735.49	203056 \$735.49

ALSO AVAILABLE IN RAILING KITS: P300 CELLULAR PVC - SEE PAGES 7-8, 13-14; A210 ALUMINUM - SEE PAGES 32-33; A310 ALUMINUM - SEE PAGES 47-48

Mesh

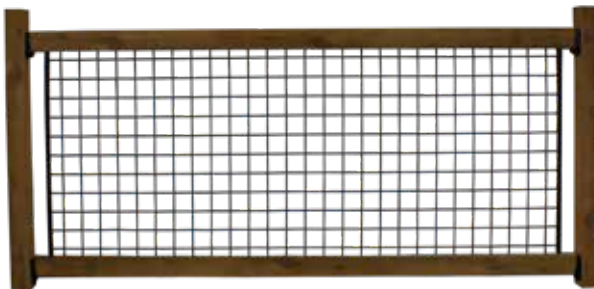

KIT INCLUDES:

- 1 Mesh Infill Panel
- 2 Side Stiles
- 4 Stile Connectors and Hardware

Mesh Panel Actual Dimensions

- 32.120" x 67.250"
- 32.120" x 90.00"

Rail Height Installation Tip

A 32.120" panel will achieve a 42" hardwood rail height. Field modification is required to achieve a 36" hardwood rail height.

Mesh Panel Infill Kits - LEVEL

Height	Length	Textured Black	Mill
36" & 42"	6'	209051 \$289.69	209050 \$289.69
36" & 42"	8'	209053 \$380.25	209052 \$380.25

ALSO AVAILABLE IN RAILING KITS: P300 CELLULAR PVC - SEE PAGES 9 & 15; A210 ALUMINUM - SEE PAGE 34; A310 ALUMINUM - SEE PAGE 49

Steel Infill Railing Systems

Steel



KIT INCLUDES:

- 1 Steel Infill Panel
- * Brackets sold separately

Steel Panel Infill Kits - LEVEL			
Height	Length	Antique Bronze	Black Sand
28"	70"	307030 \$117.99	307000 \$117.99
28"	94"	307090 \$147.55	307060 \$147.55
Steel Panel Infill Kits - STAIR			
Height	Length	Antique Bronze	Black Sand
28"	70"	307045 \$172.11	307015 \$172.11
28"	94"	307105 \$194.61	307075 \$194.61
Optional Hardware			
Item Description		Antique Bronze	Black Sand
F - Rail Bracket - Level PTP (4/pk)		307220 \$44.25	307200 \$44.25
G - Cup & Cover Bracket - Level PTP (4/pk)		307221 \$44.25	307201 \$44.25
H - Rail Multi-Pitch Bracket - Stair (4/pk)		307225 \$52.12	307205 \$52.12
I - Rail Multi-Angle Bracket - Level PTP (4/pk)		307230 \$54.09	307210 \$54.09

FOR STEEL POSTS, CAPS, TRIM, AND GATE COMPONENTS, SEE PAGES 25-26.

Image shown is a representation and may not reflect actual kit components.

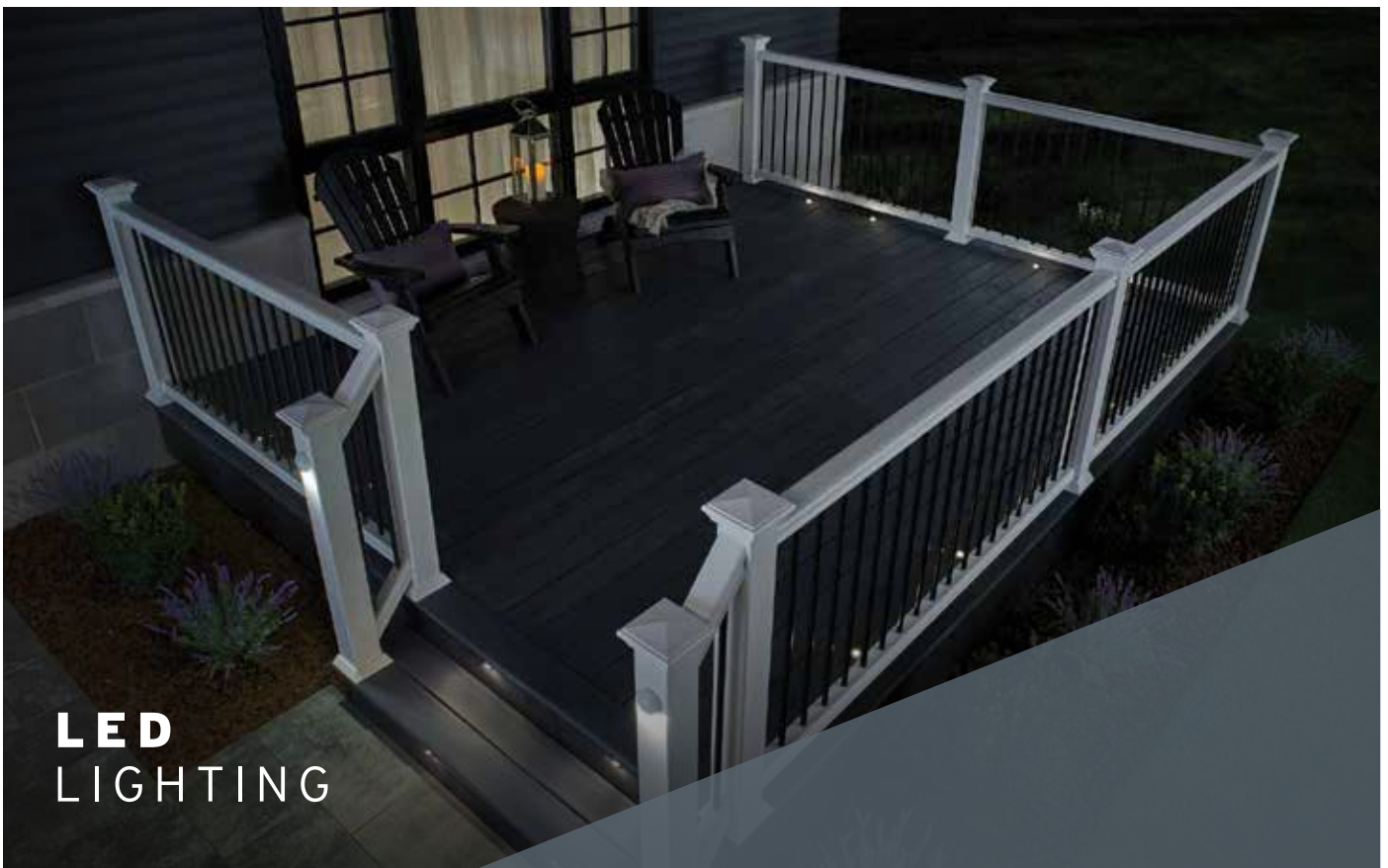

LED LIGHTING

EASY PLUG AND PLAY LED SYSTEM

Transformers simply plug into a receptacle - no need to run lengthy wire from transformer to end of project. System is constructed with male and female connectors - eliminating the hassle of cutting or splicing wires.

WEATHER RESISTANT

Self-sealing connectors are designed to resist harsh weather conditions.

DAISY CHAIN ENGINEERED

Each light has been engineered to connect to the next, allowing for effortless installation.

SOFT WARM LED LIGHT

Designed to match landscape industry standards.

CHOOSE FROM 5 LIGHTING STYLES

- Post Cap Lights
- Sconce Lights
- In-Deck Lights
- Pin Lights
- Riser Lights

OPTIONAL FEATURES

- Timer & Dimmer Switch
- Bluetooth Switch

Works with



CP310 Black with Horizontal Cable Infill and LED Lighting

LED LIGHTING FIXTURES



* Available in Aluminum Only - Matte White & Textured Black





12v LED Lighting					
Item Description	White	Khaki	Black	Aluminum ONLY	
				Matte-White	Textured Black*
A - 3", 3-1/2", 4" Post Cap Uses 1.73 Watts Dual Cord - 12" Length	N/A	N/A	N/A	901490 \$68.90	901492 \$68.90
B - 4" Post Cap Uses 1.73 Watts Dual Cord - 12" Length	901470 \$74.96	901471 \$89.96	N/A	N/A	N/A
C - 4" Carriage Light Post Cap Uses 1.73 Watts Dual Cord - 12" Length	901460 \$79.46	N/A	901461 \$79.46	N/A	N/A
D - 5-1/4" Carriage Light Post Cap Uses 1.73 Watts Dual Cord - 12" Length	901465 \$81.68	N/A	901466 \$81.68	N/A	N/A
E - Frosted Glass Inserts for Carriage Light 12v LED Post Cap (Set of 4)	901416 \$11.45	N/A	N/A	N/A	N/A
F - Post Sconce Uses 0.58 Watts Dual Cord - 36" Length	901455 \$37.39	N/A	901456 \$37.39	N/A	N/A
G - Oval Post Sconce Uses 0.36 Watts Dual Cord - 36" Length	N/A	N/A	901459 \$37.39	N/A	901458 \$37.39
H - Flush Pin Uses 0.30 Watts Dual Cord - 13" Length	N/A	N/A	901450 \$18.93	N/A	N/A
I - Strip Light** Uses 1.40 Watts Single Cord - 50" Length	901451 \$53.75	N/A	N/A	N/A	N/A
J - In Deck Light, Includes Both Black and Brushed Bronze Accent Collars Uses 0.24 Watts Dual Cord - 18" Length	N/A	N/A	901452 \$25.71	N/A	N/A
K - Stair Riser Light, Uses 0.26 Watts Dual Cord - 18" Length	N/A	N/A	901453 \$25.71	N/A	N/A

***To select the best transformer (page 150) for your installation, multiply the wattage usage of each fixture by the quantity of fixtures to be installed to calculate your total wattage requirement. The wattage rating of the transformer must be greater than the sum of the fixture wattage being installed.**

****All of these fixtures can be continuously daisy chained in any order with the exception of the Strip Light (I), which cannot be daisy chained and must be used with a 2 in 1 splitter (page 150) at the end of the chain.**

LED LIGHTING TRANSFORMERS & ACCESSORIES

 <p>A</p>	36 Watt Transformer & Accessories
 <p>B</p>	
 <p>C</p>	B - Photocell Switch for 36 Watt Transformer, On at Dusk, Off at Dawn 29" Length, End to End 901480 \$26.50
 <p>D</p>	C - 10' Extension Cable for 36 Watt Transformer, Used to Reach Direct Sunlight for the Photocell 901481 \$22.04
 <p>E</p>	D - 20' Direct Cable to Light for 36 Watt Transformer 901482 \$36.98
 <p>F</p>	E - 20' Extension Cable with Junction Box for 36 Watt Transformer - 12 Watt max per wire 901483 \$55.65
 <p>G, H</p>	F - *Bluetooth Switch for 36 Watt Transformer 29" Length, End to End (*App for Dimmer Switch: DimTek - Download from the App Store to set-up your account) 901484 \$74.20
 <p>H</p>	G - 36" Extension Cable 12v, Used to Reach Between Lights for Longer Distances 901475 \$14.02
 <p>I</p>	H - 9' Extension Cable 12v, Used to Reach Between Lights for Longer Distances 901476 \$21.62
 <p>J</p>	I - 2 in 1 Splitter 12v 29" Length, End to End 901477 \$16.36
 <p>K</p>	J - 12v LED Light Connector Box, 36 Watt Max - 12 Watt Max per Wire 10" Length, End to End 901478 \$28.05
 <p>L, M</p>	120 Watt Transformer & Accessories
 <p>M</p>	K - 12v LED Light 120 Watt Digital Timer/Photo Control Transformer 26" Plug-in Cable 901411-1 \$191.64
 <p>J</p>	L - 18/2 LED Wire 100' Spool 901413 \$44.64
 <p>K</p>	M - 18/2 LED Wire 250' Spool 901419 \$111.60
 <p>L, M</p>	J - 12v LED Light 36 Connector Box, 36 Watt Max - 12 Watt Max per Wire 10" Length, End to End 901478 \$28.05
 <p>In Deck 12v LED Light</p>	 <p>In Deck 12v LED Light</p>



ADA HANDRAILING



VINYL RAILING COLORS



2" only available in white.

ALUMINUM RAILING COLORS

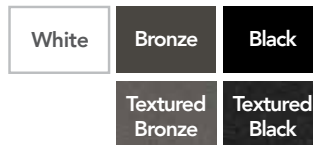

- Single Family, Multi-family Or Commercial Applications
- Low Maintenance & Easy Installation
- Ideal For ADA Accessibility Ramps & Stairs
- Vinyl ADA Components Are Aluminum Reinforced
- Meets The Requirements Of IRC Section R311, IBC Section 1011; 1012; 1014
- Handicap Compliant Per ADA Standard I/A/W DOJ 28 CFR Part 36-4

** Check Your Local Building Codes For Handrail Requirements*

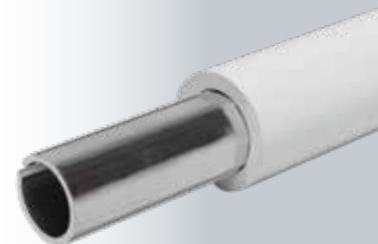

1-1/2" or 2" Vinyl Aluminum Reinforced ADA Handrailing Profile



1-1/2" Aluminum ADA Handrailing Profile

1-1/2" Vinyl ADA Secondary Handrailing

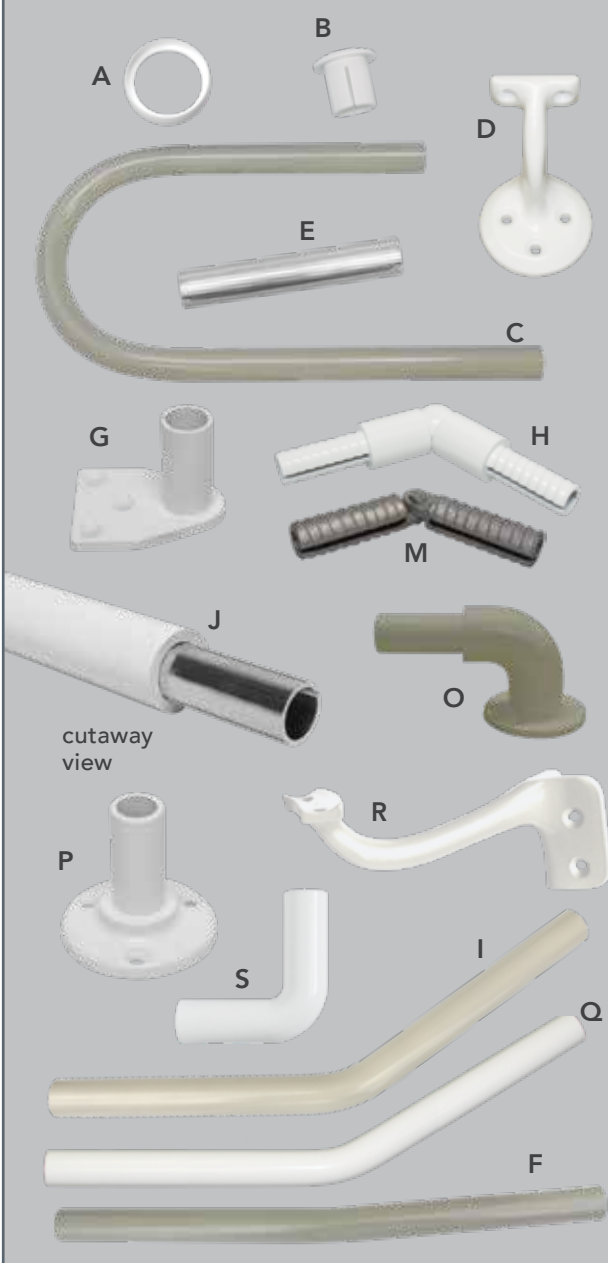

1 - 1/2" Vinyl ADA Handrailing (Hardware Included)

Components	White	Almond	Khaki
A - 1-1/2" Beauty Ring (6/plk)	401203-M \$6.95	430305-M \$7.99	401203K-M \$8.34
B - End Cap (1/plk)	401255A-M \$2.43	430313-M \$2.79	401257-M \$2.92
C - P-Loop Return	401250A-M \$35.63	430304-M \$40.98	401252-M \$42.76
D - 3" Mounting Bracket	401205-M \$13.97	430306-M \$16.07	401207-M \$16.76
E - Aluminum Connector	401260A-M \$5.65	401260TK-M \$6.50	401260TK-M \$6.50
F - 5° Radius	401220A-M \$21.47	430301-M \$24.70	401222-M \$25.77
G - Gate Return	401285-M \$41.57	430315-M \$47.81	401287-M \$49.88
H - External Adjustable Angle Swivel	401204-M \$21.69	430308-M \$24.94	401204K-M \$26.03
I - 32° Radius	401225A-M \$21.63	430302-M \$24.88	401227-M \$25.96
J - 1-1/2" x 8' 8" Handrail	401200A-M \$74.20	430300-M \$85.33	401202-M \$89.04
M - 0°-90° Universal Elbow	401246-M \$15.43	401246TK-M \$17.74	401246TK-M \$17.74
O - 90° Quick Return Bracket	401275A-M \$27.03	430307-M \$31.08	401277-M \$32.44
P - 1-1/2" Level Wall Bracket	401281-M \$31.46	430314-M \$36.18	401283-M \$37.75
Q - 38° Radius	401231A-M \$21.77	430303-M \$25.04	401233-M \$26.13
R - Inside Corner Mounting Bracket	401211-M \$29.76	430309-M \$34.22	401211K-M \$35.71
S - 90° Inside/Outside Corner Elbow	401243-M \$26.46	430310-M \$30.43	401243K-M \$31.75

ADA HANDRAILING ASSEMBLY

ADA HANDICAP COMPLIANT

1-1/2" Meets ADA Standards I/A/W
DOJ 28 CFR Part 36 Section 4

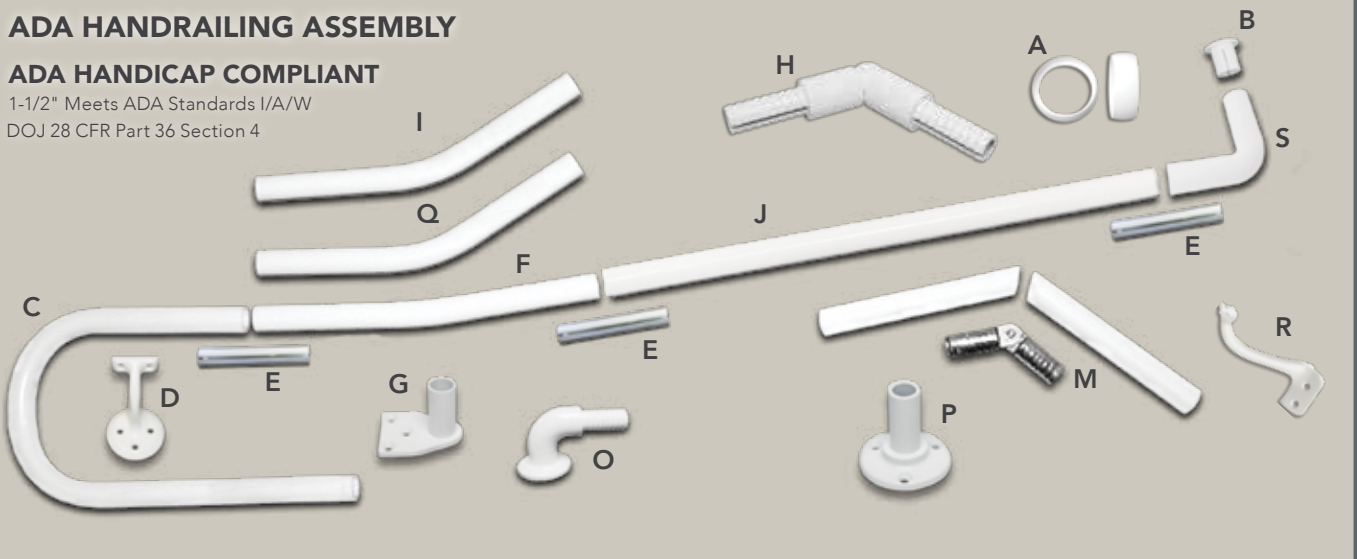

2" Vinyl ADA Secondary Handrailing

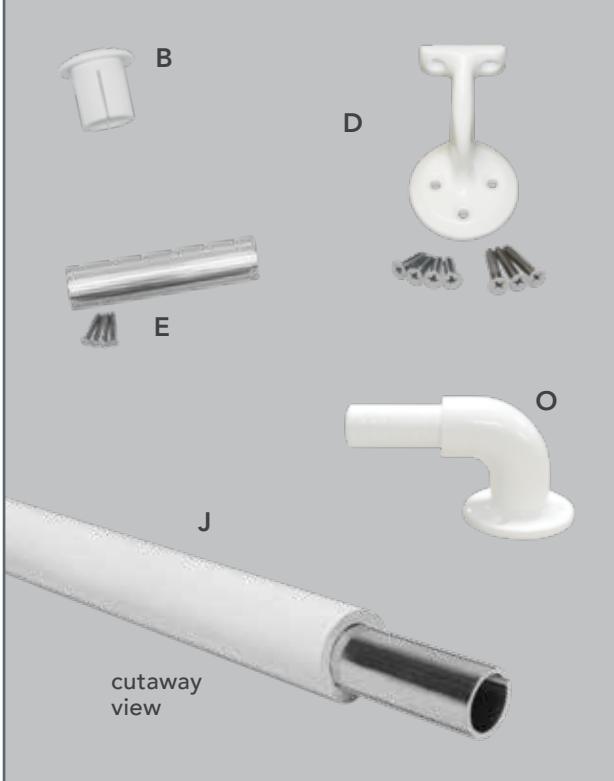

2" Vinyl ADA Handrailing (Hardware Included)	
2" Vinyl ADA Secondary Handrailing - Spans 8'	White
B - End Cap (1/pk)	401255-M \$2.88
D - 3" Mounting Bracket	401205-M \$13.97
E - Aluminum Connector	401260-M \$6.68
J - 2" x 8' 8" Handrail	401200-M \$96.38
O - 90° Quick Return Bracket	401275-M \$34.90



ADA HANDICAP COMPLIANT
 2" Meets ADA Standards I/A/W
 DOJ 28 CFR Part 36 Section 4

V110 Khaki shown with ADA Handrailing

1-1/2" Aluminum ADA Secondary Handrailing

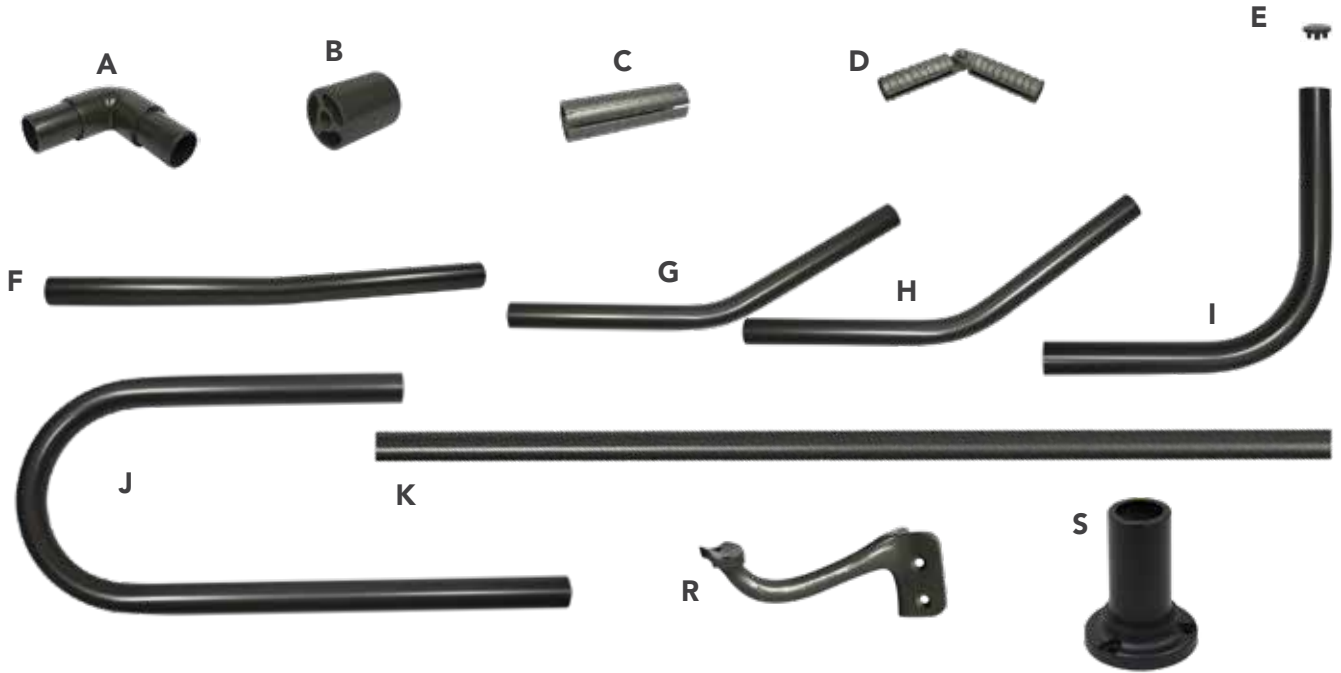

ADA HANDICAP COMPLIANT
 1-1/2" Meets ADA Standards I/A/W
 DOJ 28 CFR Part 36 Section 4

1-1/2" Aluminum ADA Secondary Handrailing

1 - 1/2" Aluminum ADA Handrailing (Hardware Included)

1.5" Handrail Components		White	Bronze	Black	Textured Bronze	Textured Black
A	90° Elbow	301086 \$17.54	301088 \$17.54	301084 \$17.54	306606 \$17.54	306604 \$17.54
B	Spacer Tube *Spacer tube bolt sold separately	301044 \$23.06	301046 \$23.06	301042 \$23.06	301046 \$23.06	301042 \$23.06
C	Straight Rail Connector	301032 \$6.08	301034 \$6.08	301030 \$6.08	Recommend using 301034	Recommend using 301030
D	Universal Angle Rail Connector	301038 \$21.02	301040 \$21.02	301036 \$21.02	Recommend using 301040	Recommend using 301036
E	End Cap	301074 \$5.09	301076 \$5.09	301072 \$5.09	301076 \$5.09	301072 \$5.09
F	5° Angle Rail	301050 \$31.23	301052 \$31.23	301048 \$31.23	306626 \$31.23	306624 \$31.23
G	32° Angle Rail	301056 \$31.23	301058 \$31.23	301054 \$31.23	306630 \$31.23	306628 \$31.23
H	38° Angle Rail	301062 \$31.23	301064 \$31.23	301060 \$31.23	306634 \$31.23	306632 \$31.23
I	90° Angle Rail	301068 \$31.23	301070 \$31.23	301066 \$31.23	306638 \$31.23	306636 \$31.23
J	P-Loop Return Angle	301026 \$47.17	301028 \$47.17	301024 \$47.17	306642 \$47.17	306640 \$47.17
K	8' Straight Handrail	301002 \$96.46	301004 \$96.46	301000 \$96.46	306602 \$96.46	306600 \$96.46
L	Quick Return Kit - 1-7/8" Post	301098 \$35.44	301100 \$35.44	301096 \$35.44	306646 \$35.44	306644 \$35.44
M	Quick Return Kit - 3-1/2" Post	301104 \$35.44	301106 \$35.44	301102 \$35.44	N/A	N/A
N	Quick Return Kit - Wall Mount	301110 \$32.43	301112 \$32.43	301108 \$32.43	306654 \$32.43	306652 \$32.43
O	Mid-rail Bracket Kit - 1-7/8" Post	301014 \$32.43	301016 \$32.43	301012 \$32.43	306658 \$32.43	306656 \$32.43
P	Mid-rail Bracket Kit - 3-1/2" Post	301020 \$32.43	301022 \$32.43	301018 \$32.43	N/A	N/A
Q	Mid-rail Bracket Kit - Wall Mount	301092 \$32.43	301094 \$32.43	301090 \$32.43	306666 \$32.43	306664 \$32.43
R	6" Inside Corner Mounting Bracket	301008 \$30.65	301010 \$30.65	301006 \$30.65	306670 \$30.65	306668 \$30.65
S	Straight Wall Mount Bracket	301122 \$41.87	301124 \$41.87	301120 \$41.87	306674 \$41.87	306672 \$41.87
T	Quick Return Kit - 3" Post	301116 \$35.44	N/A	301114 \$35.44	306678 \$35.44	306676 \$35.44
U	Mid-rail Bracket Kit - 3" Post	301117 \$32.43	N/A	301115 \$32.43	306682 \$32.43	306680 \$32.43



ITEM NUMBER - PAGE NUMBER INDEX

107300...73, 79, 87	201412...77, 140	201604...46, 138
201003...144	201414...77, 140	201605...46, 138
201008...144	201415...77, 140	201610...46, 138
201030B...143	201417...77, 140	201611...46, 138
201032B...143	201418...70, 139	201612...46, 138
201042B...143	201420...70, 139	201613...46, 138
201052B...143	201421...70, 139	201614...46, 138
201054B...143	201423...70, 139	201615...46, 138
201062B...143	201424...84, 140	201620...31, 137
201070B...143	201426...84, 140	201621...31, 137
201072B...143	201427...84, 140	201622...31, 137
201074B...143	201429...84, 140	201623...31, 137
201084...144	201430...77, 140	201624...31, 137
201086...143	201432...77, 140	201625...31, 137
201102...143	201433...77, 140	201626...31, 137
201112...143	201435...77, 140	201627...31, 137
201114...143	201500...138	201628...31, 137
201122...143	201501...138	201629...31, 137
201130...143	201502...138	201630...31, 137
201132...143	201503...138	201631...31, 137
201134...143	201504...138	201700...142
201140...143	201505...138	201701...142
201145...144	201506...138	201702...142
201149...144	201507...138	201703...142
201150...144	201508...138	201704...142
201152...143	201509...138	201705...142
201154...144	201510...138	201709...142
201160...144	201511...138	201710...142
201200...140	201512...138	201711...142
201201...140	201513...138	201712...142
201202...140	201514...138	201713...142
201206...140	201515...138	201714...142
201207...140	201516...138	201718...142
201208...140	201517...138	201719...142
201209...140	201520...137	201720...142
201210...140	201521...137	201721...142
201211...140	201522...137	201722...142
201215...140	201523...137	201723...142
201216...140	201524...137	201727...142
201217...140	201525...137	201728...142
201300...61, 139	201526...137	201729...142
201301...61, 139	201527...137	201730...142
201302...61, 139	201528...137	201731...142
201303...61, 139	201530...137	201732...142
201310...61, 139	201531...137	201800...121, 141
201311...61, 139	201532...137	201801...121, 141
201312...61, 139	201533...137	201803...121, 141
201313...61, 139	201534...137	201804...121, 141
201400...70, 139	201535...137	201806...124, 141
201402...70, 139	201536...137	201807...124, 141
201403...70, 139	201537...137	201809...124, 141
201405...70, 139	201538...137	201810...124, 141
201406...84, 140	201600...46, 138	201812...121, 141
201408...84, 140	201601...46, 138	201813...121, 141
201409...84, 140	201602...46, 138	201815...121, 141
201411...84, 140	201603...46, 138	201816...121, 141

201818...124, 141
201819...124, 141
201821...124, 141
201822...124, 141
201900...136
201905...136
201910...136
201915...136
201920...136
201925...136
202000...6, 136
202005...6, 136
202010...6, 136
202015...6, 136
202025...12, 136
202030...12, 136
202035...12, 136
202040...12, 136
203000...23, 42, 58
203001...23, 42, 58
203002...23, 42, 58
203003...23, 42, 58
203004...23, 42, 58
203005...23, 42, 58
203006...23, 42, 58
203007...23, 42, 58
203008...23, 42, 58
203009...23, 42, 58
203010...23, 42, 58
203011...23, 42, 58
203012...23, 42, 58
203013...23, 42, 58
203050...146
203051...146
203052...146
203053...146
203054...146
203055...146
203056...146
203057...146
203100A...32
203100B...32
203101A...32
203101B...32
203102A...32
203102B...32
203103A...32
203103B...32
203104A...33
203104B...33
203105A...33
203105B...33
203106A...33
203106B...33
203107A...33
203107B...33
203150A...32
203150B...32
203151A...32
203151B...32
203152A...32
203152B...32
203153A...32
203153B...32
203154A...33
203154B...33
203155A...33

203155B...33
203156A...33
203156B...33
203157A...33
203157B...33
203200A...32
203200B...32
203201A...32
203201B...32
203202A...32
203202B...32
203203A...32
203203B...32
203204A...33
203205A...33
203206A...33
203206B...33
203207A...33
203207B...33
203250A...32
203250B...32
203251A...32
203251B...32
203252A...32
203252B...32
203253A...32
203253B...32
203254A...33
203254B...33
203255A...33
203255B...33
203256A...33
203256B...33
203257A...33
203257B...33
203300A...32
203300B...32
203301A...32
203301B...32
203302A...32
203302B...32
203303A...32
203303B...32
203304A...33
203304B...33
203305A...33
203305B...33
203306A...33
203306B...33
203307A...33
203307B...33
203350A...32
203350B...32
203351A...32
203351B...32
203352A...32
203352B...32
203353A...32
203353B...32
203354A...33
203354B...33
203355A...33
203355B...33
203356A...33
203356B...33
203357A...33
203357B...33

204100A...47
204100B...47
204101A...47
204101B...47
204102A...47
204102B...47
204103A...47
204103B...47
204104A...48
204104B...48
204105A...48
204105B...48
204106A...48
204106B...48
204107A...48
204107B...48
204150A...47
204150B...47
204151A...47
204151B...47
204152A...47
204152B...47
204153A...47
204153B...47
204154A...48
204154B...48
204155A...48
204155B...48
204156A...48
204156B...48
204157A...48
204157B...48
204200A...47
204200B...47
204201A...47
204201B...47
204202A...47
204202B...47
204203A...47
204203B...47
204204A...48
204204B...48
204205A...48
204205B...48
204206A...48
204206B...48
204207A...48
204207B...48
204250A...47
204250B...47
204251A...47
204251B...47
204252A...47
204252B...47
204253A...47
204253B...47
204254A...48
204254B...48
204255A...48
204255B...48
204256A...48
204256B...48
204257A...48
204257B...48
204300A...47
204300B...47
204301B...47

204302A...47
204302B...47
204303A...47
204303B...47
204304A...48
204304B...48
204305A...48
204305B...48
204306A...48
204306B...48
204307A...48
204307B...48
204350A...47
204350B...47
204351A...47
204351B...47
204352A...47
204352B...47
204353A...47
204353B...47
204354A...48
204354B...48
204355A...48
204355B...48
204356A...48
204356B...48
204357A...48
204357B...48
207100A...7
207100B...7
207101A...7
207101B...7
207102A...7
207102B...7
207103A...7
207103B...7
207104A...8
207104B...8
207105A...8
207105B...8
207106A...8
207106B...8
207107A...8
207107B...8
207110A...13
207110B...13
207111A...13
207111B...13
207112A...13
207112B...13
207113A...13
207113B...13
207114A...14
207114B...14
207115A...14
207115B...14
207116A...14
207116B...14
207117A...14
207117B...14
207150A...7
207150B...7
207151A...7
207151B...7
207152A...7, 13
207152B...7, 13
207153A...7, 13

207153B...7, 13
207154A...8
207154B...8
207155A...8
207155B...8
207156A...8
207156B...8
207157A...8
207157B...8
207160A...13
207160B...13
207161A...13
207161B...13
207164A...14
207164B...14
207165A...14
207165B...14
207166A...14
207166B...14
207167A...14
207167B...14
209002...23, 42, 58
209003...23, 42, 58
209004...23, 42, 58
209005...23, 42, 58
209008...23, 42, 58
209009...23, 42, 58
209010...23, 42, 58
209011...23, 42, 58
209050...146
209051...146
209052...146
209053...146
209100...34
209101...34
209102...34
209103...34
209104...34
209105...34
209106...34
209107...34
209110...34
209111...34
209112...34
209113...34
209114...34
209115...34
209116...34
209117...34
209120...34
209121...34
209122...34
209123...34
209124...34
209125...34
209126...34
209127...34
209200...49
209201...49
209202...49
209203...49
209204...49
209205...49
209206...49
209207...49
209210...49
209211...49

209212...49
209213...49
209214...49
209215...49
209216...49
209217...49
209220...49
209221...49
209222...49
209223...49
209224...49
209225...49
209226...49
209227...49
209300...9, 15
209301...9, 15
209302...9, 15
209303...9, 15
209304...9, 15
209305...9, 15
209306...9, 15
209307...9, 15
230000...140
230001...140
230002...140
230003...140
230004...140
230005...140
230006...61, 139
230007...61, 139
230008...61, 139
230009...61, 139
230010...70, 139
230011...70, 139
230012...84, 140
230013...84, 140
230014...77, 140
230015...77, 140
230016...70, 139
230017...70, 139
230018...84, 140
230019...84, 140
230020...77, 140
230021...77, 140
300000...56
300000GL...56
300005...56
300005GL...56
300010...56
300010GL...56
300015...56
300015GL...56
300020...56
300020GL...56
300025...56
300025GL...56
300030...56
300030GL...56
300035...56
300035GL...56
300040...56
300040GL...56
300045...56
300045GL...56
300050...56
300050GL...56
300055...56

300055GL...56	300438...55	300685...55
300060...56	300439...55, 138	300690...55
300060GL...56	300440...55	300695...38, 54
300065...56	300443...55	300700...52, 54
300065GL...56	300444...55, 138	300705...54
300070...56	300445...55	300710...54
300070GL...56	300446...55, 138	300715...54
300075...56	300447...55	300720...54
300075GL...56	300450...55	300725...54
300080...56	300451...55	300746P...36, 51
300080GL...56	300452...55	300773...57
300085...56	300453...55	300774...57
300085GL...56	300455...55	300775...57
300255...57	300460...55	300836...45
300260...57	300465...55	300838...45
300265...57	300470...55	300840...45
300270...57	300475...55	300842...45
300275...57	300480...55	300844...45
300280...57	300485...55	300846...45
300290...52	300490...55	300848...45
300295...52	300495...55	300850...45
300300...52	300500...55	300852...45
300305...52	300505...55	300854...45
300310...52	300510...55	300856...45
300315...52	300515...53	300858...45
300320...52	300520...53	300860...45
300322...52	300525...53	300862...45
300324...52	300530...53	300864...45
300326...52	300531...53, 138	300866...45
300328...52	300535...53	300868...45
300330...52	300536...53, 138	300870...45
300332...52	300540...53	300909...45
300334...52	300541...53, 138	300911...45
300336...52	300545...55	300913...45
300338...53	300550...55	300915...45
300340...53	300555...55	300917...45
300342...53	300560...55, 138	300919...45
300344...53	300565...55, 138	300921...45
300346...53	300570...55, 138	300923...45
300348...53	300575...55	300925...45
300350...52	300580...55	300927...45
300351...52	300585...55	300929...45
300355...52	300590...55	300931...45
300356...52	300595...55	300933...45
300360...52	300600...55	300935...45
300361...52	300601...55	300937...45
300365...52	300602...55	300939...45
300366...52	300603...55	300941...45
300370...52	300605...53	300943...45
300371...52	300610...53	300964...51
300375...52	300615...53	300966...51
300376...52	300620...54	300968...51
300380...52	300625...54	300970...51
300385...52	300630...54	300972...51
300390...52	300635...53	300974...51
300391...52	300636...53, 138	301000...155
300392...52	300640...53	301002...155
300393...52	300641...53, 138	301004...155
300395...52	300645...53	301006...155
300400...52	300646...53, 138	301008...155
300405...52	300650...57	301010...155
300410...55	300655...57	301012...155
300415...55	300660...57	301014...155
300420...55	300665...54	301016...155
300425...55	300670...54	301018...155
300430...55	300675...54	301020...155
300435...55	300680...55	301022...155

301024...155
301026...155
301028...155
301030...155
301032...155
301034...155
301036...155
301038...155
301040...155
301042...155
301044...155
301046...155
301048...155
301050...155
301052...155
301054...155
301056...155
301058...155
301060...155
301062...155
301064...155
301066...155
301068...155
301070...155
301072...155
301074...155
301076...155
301084...155
301086...155
301088...155
301090...155
301092...155
301094...155
301096...155
301098...155
301100...155
301102...155
301104...155
301106...155
301108...155
301110...155
301112...155
301114...155
301115...155
301116...155
301117...155
301120...155
301122...155
301124...155
301372...22, 40, 57, 130
301373...22, 40, 57, 130
301374...22, 57, 130
301377...57
301377BZ...57
301377W...57
301380...22, 130
301381...22, 40, 57, 130
301381BZ...57
301381W...22, 40, 57, 130
301384...22, 40, 57, 130
301386...22, 40, 57, 130
301387...22, 40, 57, 130
301387BZ...57
301387W...22, 40, 57, 130
301416...22, 130
301418...22, 130
301420...22, 130

301422...22, 130
301424...22, 130
301426...22, 130
301427...22, 130
301440...22, 130
301442...22, 130
301443...22, 130
301444...22, 130
301446...22, 130
301448...22, 130
301450...22, 130
302000...46
302002...46
302004...46
302006...46
302008...46
302010...46
302012...46
302014...46
302016...46
302018...46
302020...46
302022...46
302024...46
302026...46
302028...46
302030...46
302032...46
302034...46
302036...46
302038...46
302040...46
302042...46
302044...46
302046...46
302048...46
302050...46
302052...46
302054...46
302056...46
302058...46
302060...46
302062...46
302064...46
302066...46
302068...46
302070...46
302136...45
302138...45
302140...45
302142...45
302144...45
302146...45
302148...45
302150...45
302152...45
302154...45
302156...45
302158...45
302160...45
302162...45
302164...45
302166...45
302168...45
302170...45
302175...51
302176...51

302177...51
302178...51
302179...51
302180...51
302181...51
302182...51
302183...51
302184...51
302185...51
302186...51
302187...51
302188...51
302189...51
302190...51
302191...51
302192...51
302193...51
302194...51
302195...51
302196...51
302197...51
302198...51
306000...28
306001...28
306005...28
306010...28
306011...28
306015...28
306016...28
306017...28
306018...28
306019...28
306020...28
306024...28
306025...28
306026...28
306030...28
306035...28
306036...28
306037...28
306039...28
306040...28
306045...28
306049...28
306050...28
306055...28
306056...28
306057...28
306058...28
306059...28
306060...28
306064...28
306065...28
306066...28
306067...28
306070...28
306075...28
306076...28
306080...36
306082...36
306083...36
306084...36
306086...36
306088...36
306100...39
306102...39
306105...39

306110...39
306112...39
306115...39
306120...39
306122...39
306125...39
306130...39
306132...39
306135...39
306140...39, 137
306142...39, 137
306145...39, 137
306150...39, 137
306152...39, 137
306155...39, 137
306160...37
306161...37, 137
306162...37
306163...37, 137
306164...37, 137
306165...37
306166...37
306167...37
306168...37
306170...37
306171...37, 137
306172...37
306173...37, 137
306175...37
306176...37, 137
306180K...37
306182K...37
306185K...37
306190K...37
306192K...37
306195K...37
306200K...37
306202K...37
306205K...37
306210...40
306212...40
306215...40
306220...40
306222...40
306225...40
306227...41
306228...41
306229...41
306230...41
306235...41
306236...41
306237...41
306238...41
306239...41
306240...41
306245...41
306246...41
306260...41
306265...41
306266...41
306270...41
306275...41
306276...41
306277...41
306278...41
306280...41
306281...41

306282...41
306285...41
306286...41
306287...41
306288...41
306289...37
306290...37
306292...37
306300...39
306301...39
306302...39
306310...39
306312...39
306314...39
306316...39
306318...39
306320...39
306322...39
306324...39
306326...39
306328...39
306330...39
306332...39
306335...37
306336...37
306337...37
306338...37
306339...37
306340...37
306341...37
306342...37
306343...37
306360...37
306361...37
306362...37
306363...37
306364...37
306365...37
306369...37
306370...37
306371...37
306390...41
306391...41
306392...41
306393...41
306394...41
306395...41
306396...41
306397...41
306398...41
306600...155
306602...155
306604...155
306606...155
306624...155
306626...155
306628...155
306630...155
306632...155
306634...155
306636...155
306638...155
306640...155
306642...155
306644...155
306646...155
306652...155

306654...155
306656...155
306658...155
306664...155
306666...155
306668...155
306670...155
306672...155
306674...155
306676...155
306678...155
306680...155
306682...155
306700...31
306702...31
306704...31
306706...31
306708...31
306710...31
306712...31
306714...31
306716...31
306718...31
306720...31
306722...31
306724...31
306726...31
306728...31
306730...31
306732...31
306734...31
306736...31
306738...31
306740...31
306742...31
306744...31
306746...31
306748...31
306750...31
306752...31
306754...31
306756...31
306758...31
306760...31
306762...31
306764...31
306766...31
306768...31
306770...31
306800...29
306801...29
306802...29
306803...29
306804...29
306805...29
306806...29
306807...29
306808...29
306809...29
306810...29
306811...29
306812...29
306813...29
306814...29
306815...29
306816...29
306817...29

306818...29
306819...29
306820...29
306821...29
306822...29
306823...29
306824...29
306825...29
306826...29
306827...29
306828...29
306829...29
306830...29
306831...29
306832...29
306833...29
306834...29
306835...29
306840...30
306842...30
306844...30
306850...30
306854...30
306858...30
306862...30
306866...30
306870...30
306872...30
306873...30
306874...30
306875...30
306876...30
306877...30
306878...30
306879...30
306880...30
306890...36
306891...36
306892...36
306893...36
306894...36
306895...36
306910...36
306912...36
306913...36
306914...36
306916...36
306917...36
306918...36
306919...36
306920...36
306921...36
306922...36
306923...36
306924...36
306925...36
306926...36
306927...36
306928...36
306929...36
306930...36
306931...36
306932...36
306933...36
306934...36
306935...36
307000...25, 147

307005...25
307010...25
307015...25, 147
307020...25
307025...25
307030...25, 147
307035...25
307040...25
307045...25, 147
307050...25
307055...25
307060...25, 147
307065...25
307070...25
307075...25, 147
307080...25
307085...25
307090...25, 147
307095...25
307100...25
307105...25, 147
307110...25
307115...25
307140...26
307145...26
307150...26
307155...26
307160...26
307165...26
307170...26
307175...26
307180...26
307185...26
307190...26
307195...26
307200...26, 147
307201...26, 147, 160
307205...26, 147
307210...26, 147
307215...26
307220...26, 147
307221...26, 147, 160
307225...26, 147
307230...26, 147
307235...26
307240...26
307241...26
307245...26
307246...26
307250...26
307255...26
307260...26
307261...26
307265...26
307266...26
307270...26
307275...26
307300...26
307305...26
307310...26
307315...26
307320...26, 37, 53
307322...37, 53
307324...37, 53
400120...107
400125...107
400130...107

400135...107	400526...94	400721...90
400140...107	400530...94	400724...90
400143...107	400532...94	400725...90
400150...108	400534...94	400726...91
400152...108	400536...94	400728...91
400153...108	400538...94	400729...91
400154...108	400600...60	400734...99
400170...103	400601...60	400736...99
400172...103	400604...60	400738...99
400174...103	400605...60	400740...99
400230...109	400610...65	400742...109
400231...109	400611...65	400743...109
400240...109	400615...65	400745...96
400242...109	400616...65	400750...104
400251...109	400620...65	400752...101
400251B...109	400620A...65	400754...101
400270...99	400620B...65	400756...91
400272...99	400620C...65	400758...91
400281...99	400621...65	400760...91
400282...99	400621A...65	400762...91
400288...109	400621B...65	400764...91
400288B...109	400621C...65	400766...91
400289...109	400625...60	400768...91
400289B...109	400626...60	400800...120
400295...103	400630...60	400801...120
400345...64	400631...60	400802...120
400345C...64	400632...60	400803...120
400345E...64	400633...60	400804...120
400345L...64	400635...60	400808...120
400346...97	400636...60	400809...120
400348...97	400640...60	400810...120
400350...64	400641...60	400811...120
400350C...64	400643...60	400816(B)...120
400350E...64	400644...60	400817(B)...120
400350L...64	400645...60	400818(B)...120
400351...64	400646...60	400819(B)...120
400370...109	400650...60	400820(B)...120
400372...109	400651...60	400821(B)...120
400374...109	400652...60	400822(B)...120
400376...109	400654...60	400823(B)...120
400378...109	400655...60	400824(B)...120
400380...109	400656...60	400825(B)...120
400394...109	400660...60	400826(B)...120
400396...109	400661...60	400827(B)...120
400398...109	400665...60	400828(B)...120
400400...109	400666...60	400829(B)...120
400402...109	400670...60	400830(B)...120
400404...109	400671...60	400831(B)...120
400430...93	400675...60	400832...121
400432...93	400676...60	400833...121
400434...93	400680...60	400834...121
400436...93	400681...60	400835...121
400438...93	400685...60	400836...121
400490...93	400686...60	400837...120, 121, 123
400494...93	400690...60	400838...120, 121, 123
400498...94	400691...60	400839...120, 121, 123
400500...94	400695...60	400840...121
400502...94	400696...60	400841...121
400504...97	400700...90	400842...121
400506...99	400702...90	400843...121
400508...97	400704...90	400844...120, 121, 123
400510...99	400706...90	400845...120, 121, 123
400512...97	400710...90	400846...120, 121, 123
400514...96	400712...90	400847...120, 121, 123
400520...101	400714...90	400848...127
400522...101	400716...90	400849...127
400525...104	400720...90	400850...127

400851...127
400852...127
400853...127
400854...129
400855...129
400856...129
400857...129
400858...129
400859...129
400860...129
400861...129
400862...129
400863...129
400864...129
400865...129
400866...129
400867...129
400868...129
400869...129
400870...129
400871...129
400872...129
400873...129
400874...129
400875...129
400876...129
400877...129
400901(B)...62
400902(B)...62
400903(B)...62
400904(B)...62
400905(B)...62
400906(B)...62
400907(B)...62
400908(B)...62
400909(B)...62
400910(B)...62
400911(B)...62
400912(B)...62
400913(B)...62
400914(B)...62
400915(B)...62
400916(B)...62
400917(B)...62
400918(B)...62
400919(B)...62
400920(B)...62
400922...120
400923...120
400925...120
400926...120
400928(B)...120
400929(B)...120
400931(B)...120
400932(B)...120
400981...127
400982...127
401000...68
401000A...68
401000B...68
401002A...19, 38, 54, 96, 128
401003...82
401003A...82
401003B...82
401004...69
401004A...69
401004B...69

401006...83
401006A...83
401006B...83
401007...83
401007A...69
401008...68
401009...82
401009A...68
401010A...97
401011...82
401012...69
401014...83
401015...82
401016...68
401017...69
401018A...97
401019...83
401020...64
401020A...97
401021...19, 38, 54, 96, 128
401021A...19, 23, 38, 42, 54, 58, 96, 128
401030...68
401031...82
401032...69
401033...83
401035A...88
401037A...88
401039A...88
401041A...74, 80
401043A...74, 80
401045A...74, 80
401047-1...73, 79, 87
401048...64, 100, 139
401049...101
401053...19, 38, 54, 96, 128
401054...19
401055...19
401061...96
401067...64, 97
401068...64, 97
401077...87
401078...73, 79, 87
401079...73, 79, 87
401080...73
401081...73
401082...87
401087...112
401088...74, 80
401089...88
401089A...88
401094...17, 63, 72, 78, 86, 118, 126
401099...88
401100...74, 80
401100A...74, 80
401101...74, 80
401102...74
401103...74
401105...74, 80
401106...74, 80
401107...74, 80
401110...88
401110A...88
401111...88
401112...88
401113...88
401115...88
401116...88

401117...88
401120...74, 80
401121...74, 80
401122...74
401125...74, 80
401126...74, 80
401130...88
401131...88
401132...88
401135...88
401136...88
401140...74, 80
401145...74, 80
401146...74
401150...88
401151...88
401155...88
401160...74, 80
401161...74
401165...74, 80
401170...88
401171...88
401175...88
401181...73, 79, 87
401190...72, 78, 86
401191...72, 78, 86
401192...63
401193...63
401194...126
401195...126
401197...126
401198...126
401200A-M...152
401200-M...153
401202-M...152
401203K-M...152
401203-M...152
401204K-M...152
401204-M...152
401205-M...152, 153
401207-M...152
401211K-M...152
401211-M...152
401220A-M...152
401222-M...152
401225A-M...152
401227-M...152
401231A-M...152
401233-M...152
401243K-M...152
401243-M...152
401246-M...152
401246TK-M...152
401250A-M...152
401252-M...152
401255A-M...152
401255-M...153
401257-M...152
401260A-M...152
401260-M...153
401260TK-M...152
401275A-M...152
401275-M...153
401277-M...152
401281-M...152
401283-M...152
401285-M...152

401287-M...152
401386(B)...77
401387(B)...77
401388(B)...77
401389(B)...77
401391(B)...77
401393(B)...77
401394(B)...77
401395(B)...77
401396(B)...77
401398(B)...77
401400...76
401401...76
401402...76
401403...76
401405...76
401407...76
401408...76
401409...76
401410...76
401412...76
401428...76
401429...76
401430...76
401431...76
401433...76
401435...76
401436...76
401437...76
401438...76
401440...76
401442...76
401443...76
401444...76
401445...76
401447...76
401449...76
401450...76
401451...76
401452...76
401454...76
401470...76
401471...76
401472...76
401473...76
401475...76
401477...76
401478...76
401479...76
401480...76
401482...76
401484(B)...77
401485(B)...77
401486(B)...77
401487(B)...77
401489(B)...77
401491(B)...77
401492(B)...77
401493(B)...77
401494(B)...77
401496(B)...77
401500...123
401501...123
401502...123
401508...123
401509...123
401512...123

401513...123
401520...123
401521...123
401524(B)...123
401525(B)...123
401526(B)...123
401527(B)...123
401532(B)...123
401533(B)...123
401534(B)...123
401535(B)...123
401536(B)...123
401537(B)...123
401538(B)...123
401539(B)...123
401544(B)...123
401545(B)...123
401546(B)...123
401547(B)...123
401548...124
401549...124
401550...124
401551...124
401556...124
401557...124
401558...124
401559...124
401560...124
401561...124
401562...124
401563...124
401568...124
401569...124
401570...124
401571...124
401602...85
401603...85
401606...85
401607...85
401609...85
401612...85
401613...85
401616...85
401617...85
401619...85
401630...87
401631...87
401632...87
401633...87
403000...68
403000A...68
403000B...68
403003...82
403003A...82
403003B...82
403004...69
403004A...69
403004B...69
403006...83
403006A...83
403006B...83
403007...83
403007A...69
403008...68
403009...82
403009A...68
403011...82

403012...69	406003B...83	406108...74, 80
403014...83	406003C...83	406109...74, 80
403015...82	406004...82	406110...74, 80
403016...68	406004A...82	406111...74, 80
403017...69	406004B...83	406112...88
403019...83	406004C...69	406113...88
403030...68	406005...69	406120...74, 80
403031...82	406005A...69	406121...74, 80
403032...69	406006...82	406124...88
403033...83	406006A...82	406125...88
403048...66	406007...83	406130...74
404048...66	406007A...83	406131...74
405010...115	406008...68	406132...74
405010K...115	406008A...68	406133...74
405016...115	406009...82	406134...74
405016K...115	406009A...68	406140...74, 80
405017...115	406010...97	406141...74, 80
405017K...115	406011...68	406142...74, 80
405018...115	406011A...68	406143...74, 80
405018K...115	406012...82	406144...88
405021...115	406012A...82	406145...88
405021K...115	406013...69	406146...88
405022...115	406013A...69	406147...88
405022K...115	406014...82	406150...74, 80
405023...115	406014A...82	406151...74, 80
405023K...115	406015...83	406154...88
405025...115	406015A...83	406155...88
405025K...115	406016...68	406160...88
405070...114	406016A...68	406161...88
405070K...114	406017...69	406162...88
405071...114	406017A...69	406163...88
405071K...114	406017B...69	406164...88
405072...114	406018A...97	406181...73, 79, 87
405072K...114	406019...83	406182...87
405073...114	406019A...83	406184...72, 78, 86
405073K...114	406019B...83	406186...72, 78, 86
405080...114	406020...64	406187...63
405080K...114	406020A...97	406188...63
405081...114	406030...68	406202...87
405081K...114	406030A...68	406203...87
405082...114	406031...69	406210...104, 139
405082K...114	406031A...69	406221...64, 100, 139
405083...114	406032...82	406225...100
405083K...114	406032A...82	406229...97
405181...114, 118	406033...83	406235...97
405181K...114, 118	406033A...83	406340...64
405182...114, 118	406040...97	407030...97
405182K...114, 118	406046...100	407040...97
405185...117	406047-1...73, 79, 87	408000...71
405197...115, 118	406048...64, 100, 139	408001...85
405197K...115, 118	406049...101	408002...71
405198...115, 118	406051...73, 79, 87	408003...85
405198K...115, 118	406077...87	408008...71
406000...68	406078...73, 79, 87	408009...85
406000A...68	406079...73, 79, 87	408010...71
406000B...68	406080...73	408011...85
406000C...68	406081...73	408012...71
406001...69	406085...73	408013...85
406001A...69	406086...73	408014...71
406001B...69	406087...87	408015...85
406001C...69	406088...87	408020...71
406002...82	406100...74, 80	408021...85
406002A...82	406101...74, 80	408022...71
406002B...82	406104...88	408023...85
406002C...68	406105...88	408030...71, 85
406003...83	406106...88	408040...71, 85
406003A...83	406107...88	408050...71, 85

408100(B)...70
408102(B)...70
408103(B)...70
408105(B)...70
408106(B)...70
408108(B)...70
408109(B)...70
408111(B)...70
408112(B)...70
408114(B)...70
408115(B)...70
408117(B)...70
408118(B)...70
408120(B)...70
408121(B)...70
408123(B)...70
408124(B)...70
408126(B)...70
408127(B)...70
408129(B)...70
408130(B)...84
408132(B)...84
408133(B)...84
408135(B)...84
408136(B)...84
408138(B)...84
408139(B)...84
408141(B)...84
408142(B)...84
408144(B)...84
408145(B)...84
408147(B)...84
408148(B)...84
408150(B)...84
408151(B)...84
408153(B)...84
408154(B)...84
408156(B)...84
408157(B)...84
408159(B)...84
412030...98, 110
412031...98, 110
412032...98, 110
412033...98, 110
412072...98, 110
412073...98, 110
412074...98, 110
412075...98, 110
412084...98, 110
412085...98, 110
412086...98, 110
412087...98, 110
412098...98, 110
412099...98, 110
420300...65
420320...65, 74, 80, 88
420340...65
420360...65
430000...65
430001...65
430002...65
430003...65
430004...65
430005...65
430050...65
430051...65
430100...73

430101...73
430102...79
430103...79
430104...87
430105...87
430108...73, 79, 87
430109...87
430110...87
430111...73, 79, 87
430112...73, 79, 87
430150...73
430151...73
430152...87
430153...87
430201...64, 100, 139
430202...104, 139
430203...64, 100, 139
430204...100
430205...100
430206...64, 139
430207...64, 139
430208...73, 79, 87
430209...101
430210...104
430211...101
430213...101
430214...73, 79, 87
430220...104
430221...64, 104
430223...71
430224...66
430225...73, 79, 87
430300-M...152
430301-M...152
430302-M...152
430303-M...152
430304-M...152
430305-M...152
430306-M...152
430307-M...152
430308-M...152
430309-M...152
430310-M...152
430311-M...152
430312-M...152
430313-M...152
430314-M...152
430315-M...152
430402...109
430403...109
430404...109
430408...99
430409...99
430413...109
430414...109
430415...109
430418...109
430419...109
430500...64
430501...64
430502...64, 97
430503...64
430510...97
430511...97
430512...97
430513...97
430520...97

430521...97
430540...98, 110
430541...98, 110
430542...98, 110
430543...98, 110
430544...98
430545...98
430546...98
430600...60
430601...60
430602...60
430603...60
430604(B)...62
430605(B)...62
430610...60
430611...60
430612...60
430613...60
430614(B)...62
430615(B)...62
430620...60
430621...60
430622...60
430623...60
430624(B)...62
430625(B)...62
430630...60
430631...60
430632...60
430633...60
430634(B)...62
430635(B)...62
430640...60
430641...60
430642(B)...62
430645...60
430646...60
430647(B)...62
430660...66
430661...66
430662...66
430663...66
430664...66
430670...66
430671...66
430672...66
430673...66
430674...66
430680...63
430681...63
430685...66
430686...66
430687...66
430688...66
430689...66
430690...66
430691...66
430692...66
430693...66
430694...66
430700...68
430701...68
430702...68
430703...69
430704...69
430705...69
430706(B)...70

430707(B)...70	430863...76	431003...88
430708...71	430864...76	431004...88
430710...68	430866(B)...77	431005...88
430711...68	430867(B)...77	431010...88
430712...68	430870...76	431011...88
430713...69	430871...76	431012...88
430714...69	430873...76	431013...88
430715...69	430874...76	431014...88
430716(B)...70	430876(B)...77	431015...88
430717(B)...70	430877(B)...77	431020...88
430718...71	430880...76	431021...88
430730...68	430881...76	431030...72, 78, 86
430731...68	430883...76	431031...72, 78, 86
430732...68	430884...76	435500...74, 80, 88
430733...69	430886(B)...77	435501...65
430734...69	430887(B)...77	435502...65, 74, 80, 88
430735...69	430890...76	435520...74, 80, 88
430736(B)...70	430891...76	435521...74, 80, 88
430737(B)...70	430892(B)...77	435522...65
430738...71	430895...76	435523...65
430740...68	430896...76	500000...20
430741...68	430897(B)...77	500010...21
430742...68	430900...82	500020...21
430743...69	430901...82	500030...18
430744...69	430902...82	500031...18
430745...69	430903...83	500033...22
430746(B)...70	430904...83	500034...22
430747(B)...70	430905...83	500050...18
430748...71	430906(B)...84	500051...18
430760...68	430907(B)...84	500052...18
430761...69	430908...85	500060...21
430762(B)...70	430910...82	500061...21
430770...68	430911...82	500062...21
430771...69	430912...82	500070...18, 136
430772(B)...70	430913...83	500071...18, 136
430800...74, 80	430914...83	500080...18
430801...74, 80	430915...83	500081...18
430802...74, 80	430916(B)...84	500082...18
430803...74, 80	430917(B)...84	500083...18
430804...74, 80	430918...85	500090...18
430805...74, 80	430930...82	500091...18
430806...74, 80	430931...82	500092...18
430807...74, 80	430932...82	500500...5
430808...74, 80	430933...83	500505...5
430809...74, 80	430934...83	500510...5
430810...74, 80	430935...83	500515...5
430811...74, 80	430936(B)...84	500520...5
430812...74, 80	430937(B)...84	500525...11
430813...74, 80	430938...85	500530...11
430820...74	430940...82	500535...11
430821...74	430941...82	500540...11
430822...74	430942...82	500545...11
430823...74	430943...83	500550...5
430824...74	430944...83	500555...5
430825...88	430945...83	500560...5
430826...88	430946(B)...84	500565...5
430827...88	430947(B)...84	500570...5
430828...88	430948...85	500575...11
430829...88	430960...82	500580...11
430850...76	430961...83	500585...11
430851...76	430962(B)...84	500590...11
430853...76	430965...82	500595...11
430854...76	430966...83	500600(B)...6
430856(B)...77	430967(B)...84	500605(B)...6
430857(B)...77	431000...88	500610(B)...6
430860...76	431001...88	500615(B)...6
430861...76	431002...88	500620(B)...6

500625(B)...12
500630(B)...12
500635(B)...12
500640(B)...12
500645(B)...12
500650(B)...6
500655(B)...6
500660(B)...6
500665(B)...6
500670(B)...6
500675(B)...12
500680(B)...12
500685(B)...12
500690(B)...12
500700...5
500705...5
500710...5
500715...5
500725...11
500730...11
500735...11
500740...11
500750...5
500755...5
500760...5
500765...5
500775...11
500780...11
500785...11
500790...11
500800...18
500805...18
500810...18
500830...20
500835...20
500840...20
500845...20
500860...21
500865...21
500870...21
500875...21
500890...21
500895...21
500905...20
500910...20
500915...20
500920...20
500935...21
500940...21
500945...21
500950...21
500965...21
500970...21
500980...20
500985...20
500990...20
500995...20
501010...21
501015...21
501020...21
501025...21
505000...17
505005...17
505010...17
505015...17
505020...17
505025...17

505030...17
505035...17
505100...17
900024A...97
900058...112
900062...112
900088...112
900133...74, 80, 88
900135...74, 80, 88
900142...117
900144...117
900146...117
900154...117
900156...117
900158...117
900160...117
900162...117
900164...117
900174...117
900186...115
900200...73, 79, 87
900204...73, 79, 87
900212...101
900225...101
900246...112
900247...73, 79, 87
900250...112
900256...112
900287...112
900290...112
900291...112
900293...112
900295...112
900296...112
900297...112
900298...112
900308...101
900313...101
900332...112
900333...74, 80, 88
900344...112
900345...73
900349...73
900350...104, 139
900354...104
900361...73, 79
900370...112
900371...112
900372...112
900385...87
900386...87
900387...87
900390...87
900391...79
900391K...79
900392...79
900392K...79
900404...78
900405...78
900729...115
900732...101
900734...104
900736...101
900738...101
901026...112
901040...17, 36, 51, 63, 72, 78, 86, 118, 126
901058...127

901059...127
901200...101
901201...101
901202...100
901203...64, 100, 129, 139, 141
901204...100
901209...73, 79, 87, 112, 114, 116
901210...115
901211...100
901213...117
901214...112
901216...115
901217...112
901218...115
901220...64, 100, 139
901221...100, 129, 141
901222...101
901223...129, 141
901225...64, 139
901228...129
901229...129
901268...100, 129
901269...129
901270...129
901271...129
901310...102
901311...102
901312...102
901320...102
901321...102
901322...102
901411-1...150
901413...150
901416...149
901419...150
901450...149
901451...149
901452...149
901453...149
901455...149
901456...149
901458...149
901459...149
901460...149
901461...149
901465...149
901466...149
901470...149
901471...149
901475...150
901476...150
901477...150
901478...150
901479...150
901480...150
901481...150
901482...150
901483...150
901484...150
901490...149
901492...149
902013...104
902015...104
902016...64, 104, 129, 141
902018...64, 104
902022...104
902022PW...104

902024...104
902024PW...104
903000...129
903001...129
903002...129
903003...129
903004...127
903005...127
903006...127
903007...127
903008...127
903009...127
903011...130
903015...129
903016...129
903019...129
903020...129
903146...130
903150...130
903185...129, 141
903187...128
903194...127
903199...127
903200...129, 141
903205...129, 141
903206...129
903211...129
903213...127
903214...127
903260...130
903261...130
903280...129, 141
903300...130
903304...130
904001...65
904002...65
904003...65
904004...65
904005...65
904006...65
904017...127
904024...127
904042...64, 100, 139
904044...65
904045...65
904046...64, 139
904048...65
904049...65
904068...66
904069...66
904070...66
904071...66
904072...66
904073...66
904074...66
904075...66
904076...66
904077...66
904078...66
904080...66
904081...66
904082...66
904083...66
904084...66
904085...66
904086...66
904087...66

904088...66
904089...66
904090...66
904091...66
904092...66
904093...66
904094...66
904095...66
904096...66
904097...66
904098...66
904099...66
904100...66
904101...66
904102...66
904103...66
904104...66
904105...66
904106...66
904107...66
904108...66
905100...17, 36, 51, 63, 72, 78, 86, 118, 126
905102...17, 36, 51, 63, 72, 78, 86, 118, 126
905103...17, 36, 51, 63, 72, 78, 86, 118, 126
905104...17, 36, 51, 63, 72, 78, 86, 118, 126
905105P...17, 63, 72, 78, 86, 118, 126
905611...74, 80, 88
905612...80, 88
905630...74, 80, 88
905631...74, 80, 88
905641...115
905644...73, 79, 87, 114, 116
CK4X7POST...116
CK4X8POST...116
CK4X9POST...116
CW4X7POST...116
CW4X8POST...116
CW4X9POST...116
PLR46-K142...116
PLR46-W142...116
PLR56-KF13...116
PLR56-WF13...116
PLR66-KF14...116
PLR66-WF14...116
T1303C...65
T1303W...65
T1304C...65
T1304W...65

VIEW THIS BOOK ONLINE AT WWW.FAIRWAYRAILING.COM/FAIRWAY-LIST-PRICE-BOOK

FAIRWAY ARCHITECTURAL RAILING SOLUTIONS ©2020

FairwayRailing.com

MLC001-08