

DELTANA

EXPLORE A LARGE SELECTION OF HIGH QUALITY DOOR AND ARCHITECTURAL HARDWARE IN STOCK AND READY TO SHIP

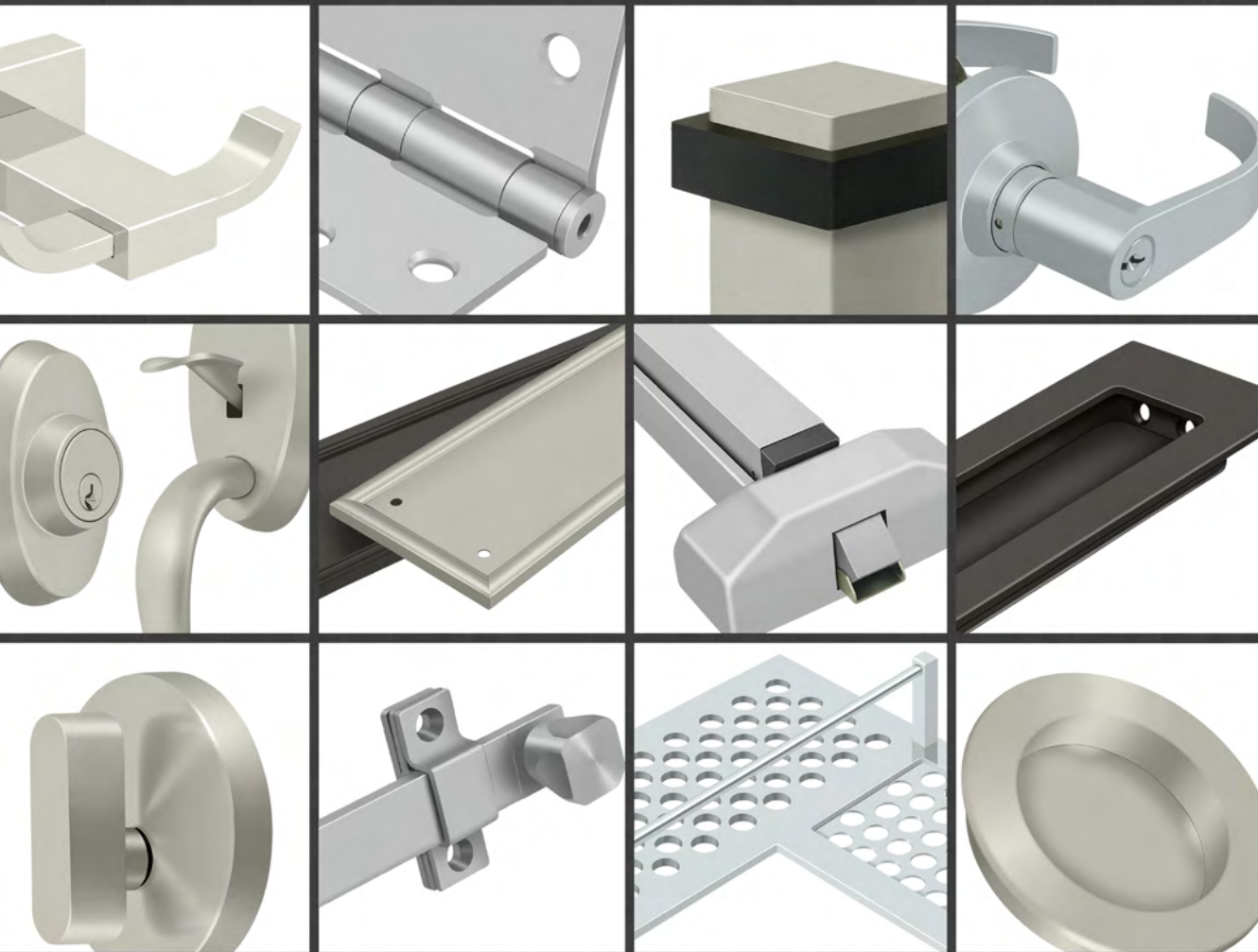

Index

Adjustable Pulls	7 - 10	Hinges, Concealed Invisible	2 - 10	Stainless Steel Hinges	3 - 2
Ball Catches	6 - 2	Hinges, HD Royal Series	2 - 4	Steel Hinges	3 - 5
Ball Tension Catches	6 - 3	Hinges, Ornate	2 - 2	Steel Hinges with Ball Tips	3 - 5
Bar Pulls, Stainless Steel	7 - 10	Hinges, Spring	3 - 11	Stops	5 - 2
Barrel Bolt, Solid Brass	4 - 7	Hinges, Stainless Steel	3 - 2	Storm Door Latches	8 - 2
Barrel Bolts, Stainless Steel	4 - 8	Hinges, Steel	3 - 5	Storm Door Latch Accessories	12 - 7
Barrel Pins, Steel Residential Hinges	12 - 8	Hinges, Steel w/ Ball Tips	3 - 5	Strikes & Miscellaneous, Commercial	14 - 9
Baseboard Door Bumpers & Spring Stop	5 - 2	Hinges, Solid Brass	1 - 4	Strike Plates, Adjustable Dust-Proof	12 - 3
Bathroom Accessories	11 - 2	Hinges, Wide Throw, Solid Brass	1 - 7	Strike Plates, Ball & Roller Catches	12 - 2
Bell Buttons	8 - 4	Hooks	9 - 3	Strike Plates, Catches	12 - 3
Bell Button Mechanism, Replacement	12 - 8	Jamb Bracket for Dbl. Action Spring Hinge	3 - 12	Strike Plates, Commercial Locks	12 - 3
Bolts	4 - 2	Kick Plates	7 - 4	Strike Plates, Deadbolt	12 - 4
Bumpers	5 - 2	Kickdown Holders	5 - 5	Strike Plates, Dust-Cup	12 - 4
Cabin Hooks	9 - 2	Knobs	7 - 7	Strike Plates, Extended	12 - 2
Cabinet Knobs	7 - 7	Knobs, Cone	7 - 8	Strike Plates, Flushbolt	12 - 4
Cabinet Hook Eye	12 - 3	Knobs, Residential Locks	15 - 12	Strike Plates, Latch	12 - 4
Cabinet Finials	2 - 7	Knockers	8 - 5	Surface Bolts, Accessories	12 - 8
Cabinet Hinges	2 - 7	Latches & Cylinders, Residential	15 - 15	Surface Bolts, Concealed Screws	4 - 6
Cabinet Locks	10 - 4	Latches, UL Listed, Commercial	14 - 9	Surface Bolts, Offset	4 - 4
Cabinet / Mirror Pulls	7 - 4	Letters 4", Solid Brass	9 - 7	Surface Bolts, Straight	4 - 5
Casement Stays	10 - 2	Levers, Solid Brass, Elite	15 - 4	Switch Plates	9 - 5
Catches	6 - 2	Levers, Traditional	15 - 8	Transom Catch	10 - 4
Chain Door Guard	8 - 4	Levers, Zinc, Elite	15 - 5	Transom Chain	5 - 8
Coat & Hat Hooks	9 - 3	Locks, Commercial Grade 1	14 - 3	Strikes for Roller	12 - 2
Concealed Screw Surface Bolts	4 - 6	Locks, Commercial Grade 2	14 - 4	Universal Floor Bumpers	5 - 4
Corner Chisels	12 - 4	Locks, Commercial Grade 2, Light Duty	14 - 7	Valet Hooks	9 - 3
Crash Chains	5 - 8	Magnetic Catches	6 - 3	Viewers	8 - 5
Deadbolt, Solid Brass, Elite	15 - 5	Magnetic Stops & Holders	5 - 2	Wall Mount Bumpers	5 - 5
Deadbolt, Traditional	15 - 14	Mail Slot Accessories	8 - 3	Wide Pull	7 - 8
Deadbolt, Zinc, Elite	15 - 5	Mail Slots and Sleeves	8 - 3	Window & Door Pin	10 - 4
Deltana Crown PVD Hinges	1 - 4	Modern Angle Pulls, Aluminum	7 - 12	Window & Utility Pulls	7 - 6
Distressed Finials	2 - 4	Modern Pulls, Stainless Steel	7 - 11	Window Hardware	10 - 2
Distressed Hinges	2 - 3	Mortise Bolts	4 - 3	Window Lift	10 - 3
Dome Stops, Magnetic & Standard	5 - 3	Numbers 4" & 6", Solid Brass	9 - 9	Window Locks	10 - 3
Door Closers	13 - 2	Numbers 4", Zinc Die-Cast	9 - 10	Window Sash Locks	10 - 3
Door Closer Accessories	13 - 7	Offset Handle Pulls, Solid Brass	7 - 4	Wire Baskets, Corner	11 - 13
Door Guards, Security	8 - 4	Offset Surface Bolts, Solid Brass	4 - 4	Wire Baskets, Rectangular	11 - 12
Door Knockers	8 - 5	Olive Knuckle Hinges, Solid Brass	2 - 5	Wire Basket Hooks	11 - 13
Door Pulls	7 - 2	Ornate Hinges, Solid Brass	2 - 2	Wire Pulls	7 - 9
Door Viewers	8 - 5	Overhead Door Holder	5 - 8		
Drop Latch	9 - 3	Parliament Hinges	2 - 10		
Dust-Proof Strikes	12 - 3	Pins for Steel Residential Hinges	12 - 8		
Dutch Bolts	4 - 7	Pivot Base	2 - 9		
Dutch Door Quadrant	4 - 7	Pivot Hinges	2 - 9		
Edge Pulls	7 - 7	Plates for Double Action Spring Hinge	3 - 12		
Exit Devices	14 - 8	Plates Pre-drilled For Pulls	7 - 2		
Exit Device Trim Kits	14 - 8	Plates with Pulls Installed	7 - 3		
Extra Extension Rods	12 - 4	Pocket Door Bolt	8 - 7		
Extension Flush Bolts	4 - 2	Pocket Locks	8 - 6		
Finials for Royal Series	2 - 4	Pocket Lock Receiver	8 - 6		
Finials, Solid Brass	1 - 7	Push Plates, Solid Brass	7 - 3		
Flag Pole Holders	9 - 6	Push Plates, Stainless Steel	7 - 3		
Floor Mount Bumpers	5 - 6	Replacement Door Knobs	15 - 14		
Flush Bolts	4 - 3	Robe Hooks	9 - 4		
Flush Mount Bumpers	5 - 6	Roller Catches	6 - 2		
Flush Pulls	7 - 5	Rosettes For Knobs & Pulls	7 - 7		
Flush Pulls, Victorian	7 - 5	Rubber Ring, Replacement	12 - 7		
Flush Ring Pulls	7 - 9	Screen Door Latches, Mortise	8 - 2		
Frames Push Plates	7 - 3	Screw Covers	12 - 8		
Friction Casement Stay	10 - 2	Screws, Solid Brass	12 - 6		
Gambit	12 - 8	Screws, Steel	12 - 5		
Garment Hooks	9 - 3	Security Bolts, HD Stainless Steel	4 - 8		
Grab Bars, 88 Series, Solid Brass	11 - 10	Security Pin	5 - 8		
Grab Bars, Stainless Steel	11 - 10	Shell Pulls	7 - 8		
Half Surface Hinges	2 - 8	Shower Shelves	11 - 11		
Hand Rail Brackets	9 - 2	Shutter Bar / Door Latches	10 - 3		
Handleset, Solid Brass, Elite	15 - 3	Shutter Door Holders, Solid Brass	10 - 4		
Handleset, Solid Brass, Traditional	15 - 8	Speciality Solid Brass Hinges & Finials	2 - 2		
Hinge Barrel Pins, Stainless Steel	12 - 8	Spring Bolt, Stainless Steel	4 - 7		
Hinge Pin Stops	5 - 7	Spring Hinges, Double Action	3 - 12		
Hinges, Double Action Spring	3 - 12	Spring Hinges, Single Action, UL Listed	3 - 11		

Table of Contents

1 Solid Brass Hinges & Finials

About Deltana Solid Brass Hinges	1-2
Solid Brass Hinges	1-4
Wide Throw Hinges	1-7
Solid Brass Finials	1-7

2 Speciality Solid Brass Hinges & Finials

Ornate Hinges & Finials	2-2
Distressed Hinges	2-3
Distressed Finials	2-4
Heavy Duty Hinges - Royal Series	2-4
Royal Finial: for DSB45RM Series	2-4
Olive Knuckle Hinges	2-5
Cabinet Hinges	2-7
Half Surface Hinges	2-8
Cabinet Finials	2-8
Pivot Hinges	2-9
Pivot Base	2-9
Parliament Hinges	2-10
Invisible, Concealed Hinges	2-10

3 Steel, Stainless Steel & Spring Hinges

Stainless Steel Hinges	3-2
Steel Hinges	3-5
Pins for Steel Residential Hinges	3-10
Spring Hinges, Single Action	3-11
Spring Hinges, Double Action	3-12
Jamb Bracket for Dbl. Action Spring Hinge	3-12
Plates for Double Action Spring Hinge	3-12

4 Bolts

Extension Flush Bolts	4-2
Flush Bolts	4-3
Mortise Bolt	4-3
Offset Surface Bolts	4-4
Surface Bolts	4-5
Concealed Screw Surface Bolts	4-6
Dutch Door Quadrant	4-7
Dutch Door Bolt	4-7
Barrel Bolts, Solid Brass	4-7
Spring Bolt, Stainless Steel	4-7
Barrel Bolts, Stainless Steel	4-8
Security Bolts, HD Stainless Steel	4-8

5 Bumpers & Stops

Magnetic Door Holders / Stop	5-2
Baseboard Door Bumpers	5-2
Dome Stop & Magnetic Dome Stop	5-3
Universal Floor Bumpers	5-4
Kickdown Holders	5-5
Floor Door Bumpers	5-5
Wall Mount Bumpers	5-5
Floor Mount Bumpers	5-6
Flush Mount Bumpers	5-6
Hinge Pin Stops	5-7
Extended Button Tip	5-8
Overhead Door Stop & Holder	5-8
Crash Chain	5-8
Transom Chain	5-8
Security Pin	5-8

6 Catches

Ball Catches	6-2
Roller Catches	6-2
Strikes for Catches	6-3
Adjustable Ball Tension Catches	6-3
Magnetic Catches	6-3

7 Knobs, Pulls & Plates

Door Pulls	7-2
Plates Pre-Drilled for Pulls	7-2
Plates with Pulls Installed	7-3
Framed Push Plates	7-3
Push Plates, Solid Brass	7-3
Push Plates, Stainless Steel	7-3
Offset Handle Pulls	7-4
Kick Plates, Stainless Steel	7-4
Drawer, Cabinet & Mirror Pulls	7-4
Flush Pulls	7-5
Victorian Flush Pulls	7-5
Window & Utility Pulls	7-6
Edge Pulls	7-7
Knobs	7-7
Cone Knobs	7-8
Shell Handle Pulls	7-8
Wide Pulls	7-8
Wire Pulls	7-9
Flush Ring Pulls	7-9
Adjustable Pulls	7-10
Bar Pulls Solid Stainless Steel	7-10
Modern Pulls Stainless Steel	7-11
Modern Angle Pulls, Aluminum	7-12

8 Door Accessories

Screen/Storm Door Latches	8-2
Mail Slots	8-3
Mail Slot Accessories	8-3
Security Door Guards	8-4
Chain Door Guard	8-4
Bell Buttons	8-4
Door Knockers	8-5
Door Viewer	8-5
Pocket Locks Receiver	8-6
Pocket Locks	8-6
Pocket Door Bolt	8-7

9 Home Accessories

Hand Rail Brackets	9-2
Cabin Hooks	9-2
Valet Hook	9-3
Drop Latch	9-3
Garment Hooks	9-3
Robe Hooks	9-4
Switch Plates	9-5
Flag Pole Holders	9-6
Solid Brass Letters 4"	9-7
Solid Brass House Numbers	9-9
Zinc Die-Cast House Numbers	9-10

10 Window Hardware

Casement Stay Adjusters	10-2
Shutter Bar, Door Latches	10-3
Window Locks	10-3
Window Lift	10-3
Window Sash Locks	10-3
Shutter Door Holders	10-4
Transom Catch	10-4
Cabinet Locks	10-4
Sliding Door & Window Pin	10-4

11 Bathroom Accessories

55D: Modern Series	11-2
BBS: Modern Series	11-3
88: Modern Series	11-4
R: Traditional Series	11-6
ZA: Modern Value Series	11-7
BBN: Modern Value Series	11-8
Stainless Steel Grab Bars	11-9
Grab Bars from 88 Series	11-10

11 Bathroom Accessories

HD Shower Shelves	11-11
Rectangular Wire Baskets	11-12
Corner Wire Baskets	11-13
Wire Basket Hook	11-13

12 Miscellaneous: Strikes, Screws & Accessories

Extended Strike Plates	12-2
Strike Plates for Ball and Roller catches	12-2
Strikes for Surface Bolts	12-3
Strikes for Catches	12-3
Strikes for Commercial Locks	12-3
Adjustable Dust-Proof Strikes	12-3
Cabin Hook Eye	12-3
Corner Chisels	12-4
Flush Bolt Strikes	12-4
Button Tip Finials	12-4
Dust Cup, Deadbolt & Latch Strikes	12-4
Extra Extension Rods	12-4
Steel Screws	12-5
Solid Brass Screws	12-6
Replacement Rubber Bumper Bands	12-7
Screen & Storm Door Latch Accessories	12-7
Surface Bolt Accessories	12-8
Pins for Steel Residential Hinges	12-8
Barrel Pins for Solid Brass Hinges	12-8
Screw Covers	12-8
Replacement Bell Button Mechanism	12-8
The Deltana Gambit	12-8

13 Door Closers & Accessories

DC50	13-2
DC70	13-3
DC10	13-4
DC90	13-5
DC40	13-6
Door Closer Accessories	13-7

14 Commercial Door Hardware

Grade 1 Clarendon Lever	14-3
Grade 1 Deadbolts	14-3
Grade 1 Clarendon Lever IC Core	14-3
Grade 2 Clarendon Lever	14-4
Grade 2 Deadbolts	14-4
Grade 2 Curved Lever	14-5
Grade 2 Round Knobs	14-5
Grade 2 Interconnected	14-6
Grade 2 Clarendon Lever IC Core	14-6
Grade 2 Light Duty Locks	14-7
Exit Devices	14-8
Exit Device Trim Kits	14-8
Latches, UL Listed	14-9
Strikes & Miscellaneous Items	14-9

15 Residential Door Hardware

Elite Collection	
Handlesets, Solid Brass	15-3
Levers, Solid Brass	15-4
Deadbolt, Solid Brass	15-5
Deadbolts, Zinc	15-5
Levers, Zinc	15-5

Traditional Collection

Handlesets, Solid Brass	15-8
Levers	15-8
Knobs	15-12
Replacement Door Knobs	15-14
Deadbolts	15-14
Latches & Cylinders	15-15

Finish Codes

BHMA	US NO.	US NO. DESCRIPTION OF FINISH
600	USP(W)	Prime Coat (White)
601	US1B	Paint Black
604	US2D	Zinc Dichromate
605	US3	Polished Brass
605	US3 – UNL	Unlacquered Brass
606	US4	Brushed Brass
609	US5	Antique Brass
613	US10B	Oil-rubbed Bronze
618	US14	Polished Nickel
619	US15	Brushed Nickel
620	US15A	Antique Nickel
622	US19	Paint Black
625	US26	Polished Chrome
626	US26D	Brushed Chrome
629	US32	Polished Stainless
630	US32D	Brushed Stainless
NA	H2H	Galvanized
PVD	CR003	PVD Polished Brass

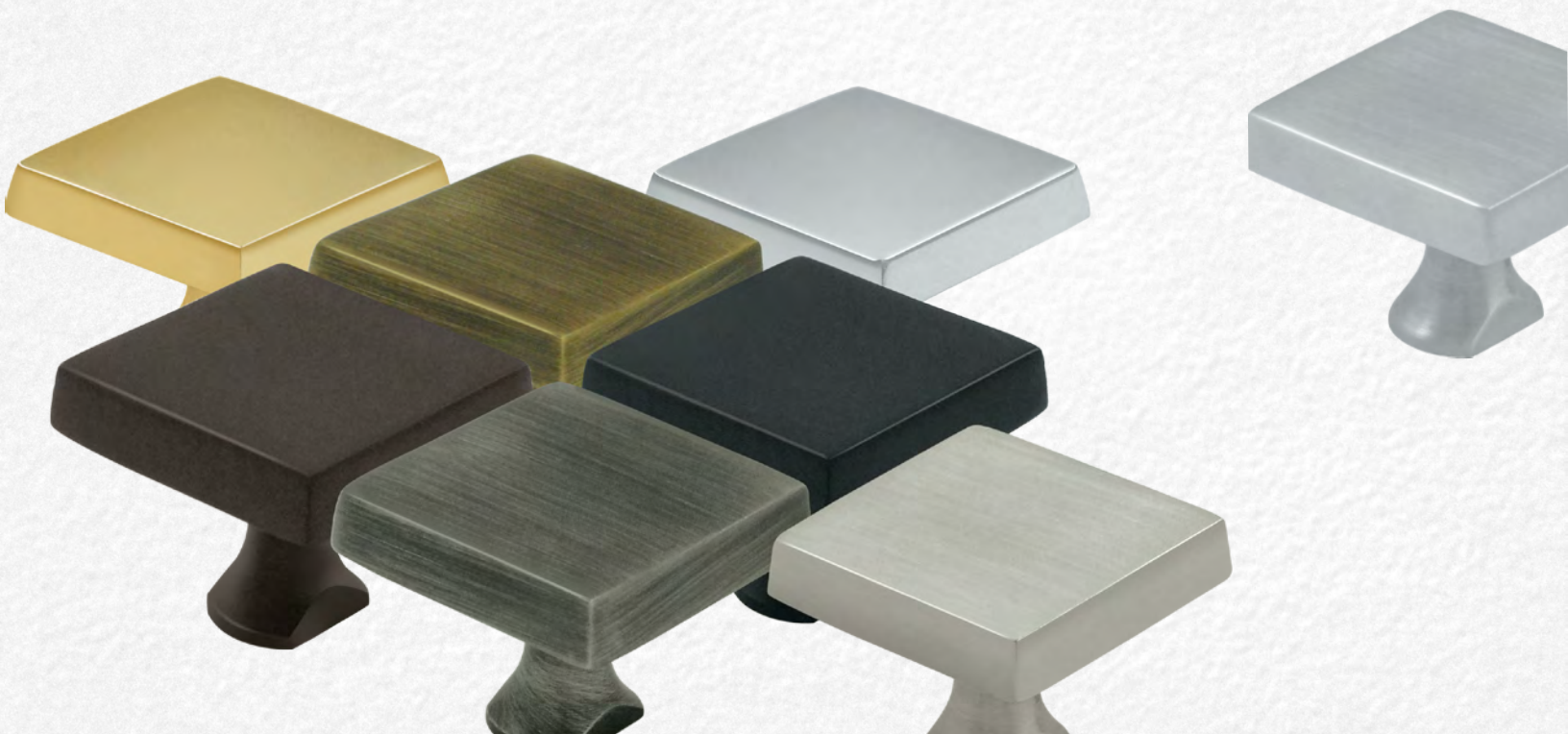

Standard Finishes



PVD



POLISHED BRASS



BRUSHED BRASS



ANTIQUE BRASS

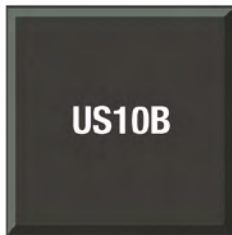

OIL RUBBED BRONZE

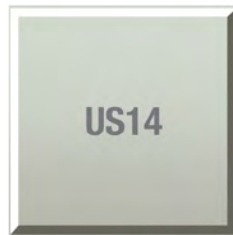

POLISHED NICKEL

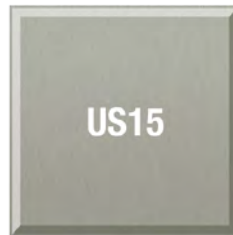

SATIN NICKEL



ANTIQUE NICKEL

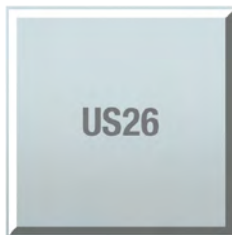

POLISHED CHROME

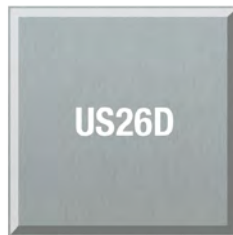

BRUSHED CHROME

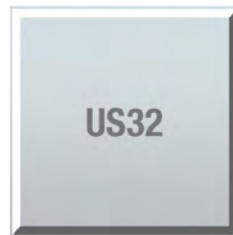

POLISHED STAINLESS STEEL



BRUSHED STAINLESS STEEL

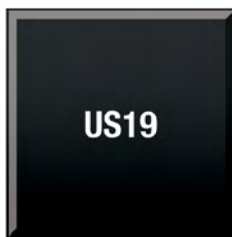

PAINT BLACK

Custom Finishes

Go beyond our large selection of standard finishes and let us help you match your imagination.



Display Program

Display Boards make a big impact on selling products to your customers. If your customer can touch it, he or she is more likely to buy it. Deltana offers a wide array of display boards that feature its full line of door, bathroom and kitchen hardware.

Display Program / Upright Boards - 22"x 14" / Hardware Boards

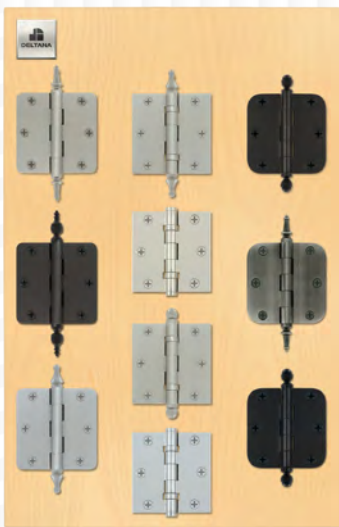

BOARD 1
Solid Brass Standard and Residential Hinges

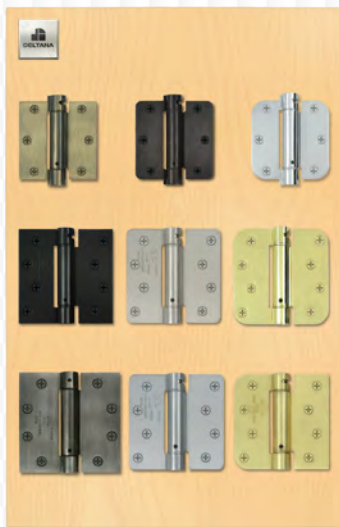

BOARD 2
Steel Single Action Spring Hinges

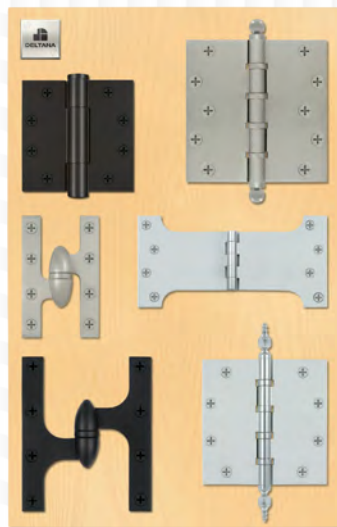

BOARD 3
Parliament & Olive Knuckle Hinges



BOARD 4
Pivot & Cabinet Hinges



BOARD 6
Overhead Door Closers



BOARD 7
Surface, Offset and Concealed Screw Bolts



BOARD 8
Bumpers & Catches

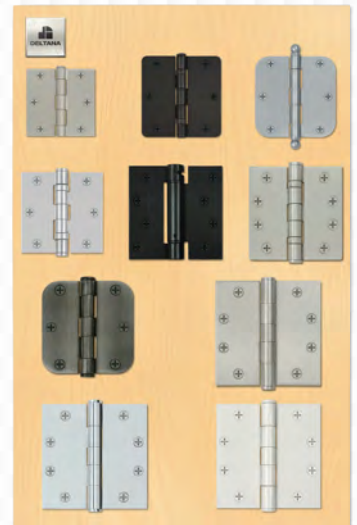

BOARD 9
Steel Radius, Square & Heavy Duty Hinges

Display Program

22"x 14" single board	\$75 net
22"x 29" double wide board	\$90 net
Tower spinner with no boards	\$250 net
Tower with boards to fit	\$1000 net
Lock stands	\$50 net

Display Program / Upright Boards - 22"x 14" / Hardware Boards

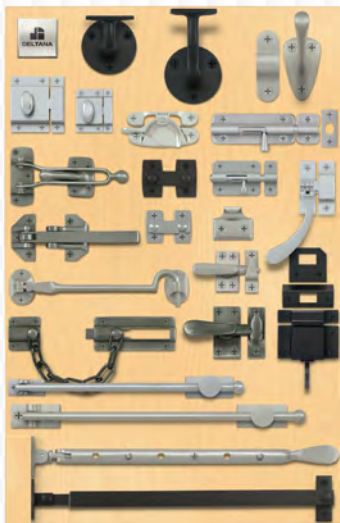

BOARD 10
Solid Brass Home Accessories



BOARD 11
Solid Brass Door Hardware

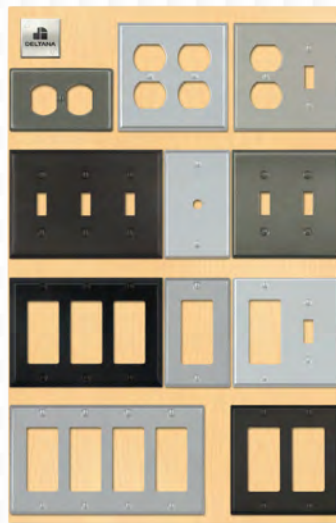

BOARD 15
Switch Plates



BOARD 16
Cabinet Knobs & Pulls



BOARD 17
Solid Brass Push Plates & Door Pulls



BOARD 18
Solid Brass Push Plates



BOARD 20
Distressed Hinges & Finials

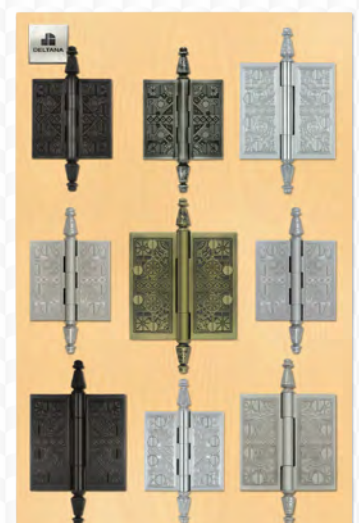

BOARD 22
Solid Brass Ornate Hinges

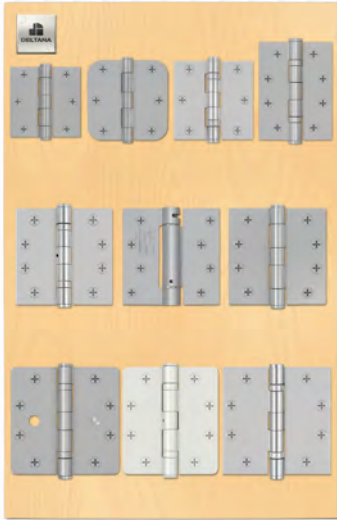

BOARD 29
 Square & Radius Corner
 Stainless Steel Hinges



BOARD 13
 Solid Brass Bathroom
 Wire Baskets



BOARD 30
 Heavy Duty Bathroom Baskets



BOARD 33
 Flush Pulls

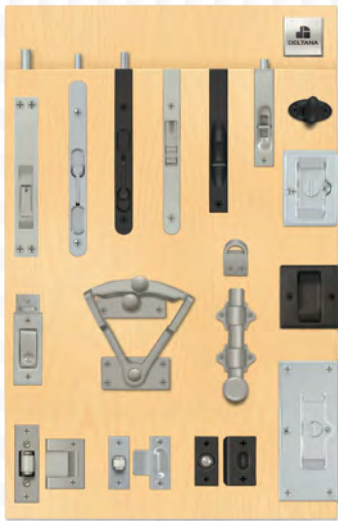

BOARD 34
 Pocket Locks, Flush Bolts
 & Ball Catches



BOARD 35
 Residential Hooks



BOARD 12 R Series Bathroom Accessories / Solid Brass

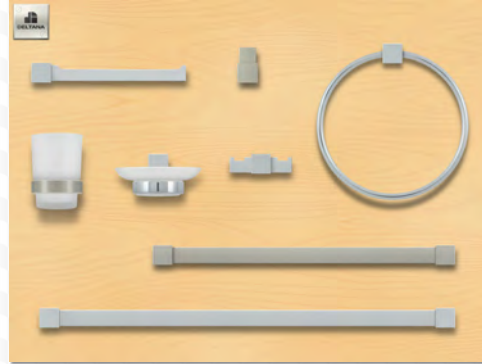

BOARD 31 ZA Series Bathroom Accessories / Zinc

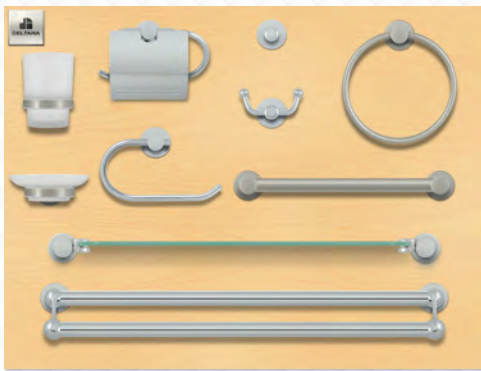

BOARD 24 BBN Series Bathroom Accessories / Zinc



BOARD 32 55D Series Bathroom Accessories / Solid Brass

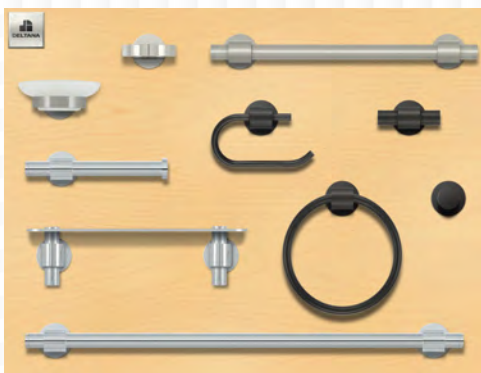

BOARD 25 BBS Series Bathroom Accessories / Solid Brass

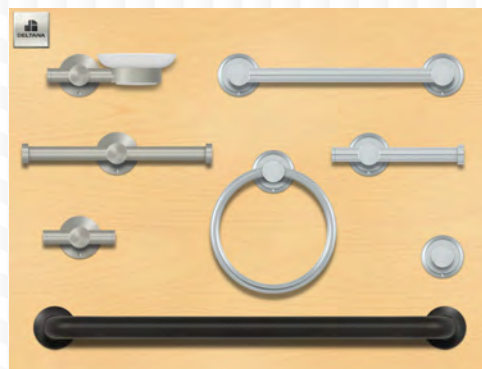

BOARD 27 88 Series Bathroom Accessories / Solid Brass

COMMERCIAL DOOR HARDWARE STANDS

STAND C1

Grade 1 Commercial Lock
Clarendon Lever

STAND C3

Grade 2 Commercial Lock
Curved Lever

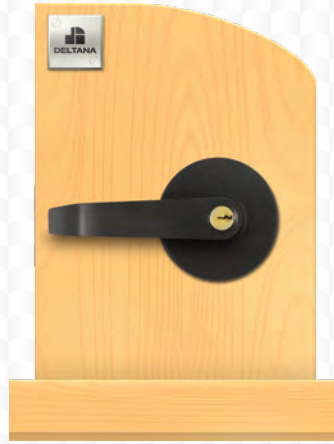
STAND C2

Grade 2 Commercial Lock
Clarendon Lever

STAND C4

Interconnected Locks

POCKET DOOR LOCKS STANDS

STAND PDL1

SDL980 - Storm Door Lock
Solid Brass

STAND PDL2

SDLS480 - Storm Door Lock
Solid Brass

STAND PDL3

SDML334 - Storm Door Mortis Lock
Solid Brass

STAND PDL4

SDL688 - Storm Door Mortis Lock
Solid Brass

ELITE RESIDENTIAL LOCKS STANDS

STAND E4
Highgate Handleset
Solid Brass



STAND E3
Riversdale Handleset
Solid Brass



STAND E1
Zinc Deadbolt
Solid Brass Lacovia Lever
Solid Brass Chapelton Lever

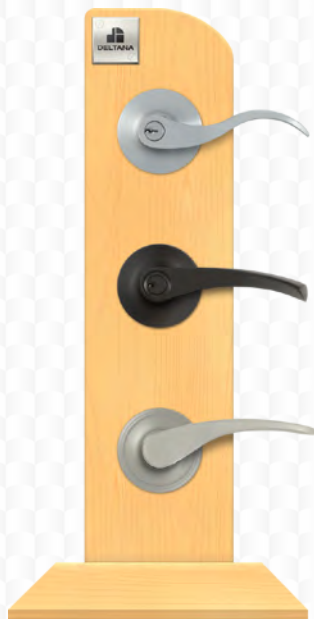

STAND E2
Zinc Mandeville Lever
Zinc Livingston Lever
Zinc Portmore

RESIDENTIAL LOCKS STANDS

STAND R1
Savanna Lever
Claremont Lever
Trelawny Lever



STAND R2
Manchester Lever
Linstead Lever
Morant Lever



STAND R3
Round Knob
Portland Knob
Egg Knob



STAND R4
Hanover Handleset
Montego Handleset

THE DELTANA SPINNING DISPLAY TOWER**Tower Specifications**

- 3 Sided, 32" Maximum diameter rotatable base. And 80" tall.
- Can hold up to 6 up-right boards (22"x 14") on each side (total of 18 up-right boards).
- Can hold up to 3 wide boards (22"x 29") on each side (total of 9 wide boards)
- Easy to assemble.
- All Deltana boards retrofit easily.
- Display Program

22"x 14" single board _____ **\$75 net**

22"x 29" double wide board _____ **\$90 net**

Tower spinner with no boards _____ **\$250 net**

Tower with boards to fit _____ **\$1000 net**

Lock stands _____ **\$50 net**

Terms and Conditions of Sale

TERMS:

Deltana agrees to sell to Buyer, on an open account, COD or prepaid basis at Deltana's sole discretion, such goods as Deltana has available at its then current sales price. Outstanding balances accrue interest from the date of the invoice at the highest rate permitted by law until paid in full. The risk of loss for all goods shifts to Buyer at the location of Deltana's warehouse. Buyer shall pay all of Deltana's costs, which shall include attorney's fees, associated in any way with enforcement of the Agreement, at all levels of proceedings, including appeals. Buyer waives trial by jury, consents unconditionally to jurisdiction in the State of Florida, agrees that all legal proceedings relating to any matter arising or related to the Agreement must be filed in Miami-Dade County, Florida, and agrees that any such proceeding shall be governed by Florida law.

PRICING:

List prices, customer discounts and net prices are subject to change without notice. All shipments will be invoiced according to current prices in effect at time of order. All prices shown in the price list are in U.S. Dollars. Deltana is not responsible for misprints or typographical errors. Deltana reserves the right to discontinue or change specifications on any item without notice and without incurring any obligation. Additional transaction costs to Deltana such as bank transaction and currency exchange fees from either the Buyer's bank and/or Deltana's bank, are the liability of the Buyer and will be applied as appropriate.

DELIVERY:

All goods are shipped "F.O.B. Miami: Deltana Warehouse." Full freight will be allowed on shipments with a minimum net invoice of \$500.00 to destinations within the contiguous United States. Full performance by Deltana shall be deemed to have occurred upon shipment from Deltana. Out-of-stock items will be back-ordered unless otherwise noted by customer. Deltana reserves the right to select the final carrier for any shipment. Shipments will be made to the common carrier in good condition. When delivered to the carrier, shipments become the property of the purchaser who assumes the risk of loss or damage in transit.

CLAIMS & RETURNS:

Authorization for the return of items is at the full discretion of Deltana. Buyers of record must make all claims for damages and shortages to Deltana within 5 days of delivery. Deltana will not accept returned goods without express authorization from Deltana's return department. All products returned must be in good and original condition according to Deltana standards and will be credited to the customer's account, less a 20% restocking charge. All returned goods must be shipped FREIGHT PREPAID.

PAST DUE ACCOUNTS:

Invoices not paid within our terms of 10 days will be subject to a service charge of 2% per month. A 24% per annum service charge will be added and compounded each month thereafter until said amount is collected. Buyer agrees to pay attorney's fees incurred by Deltana in collection of overdue accounts.

MAP Policy

To ensure the viability and profitability of our products for our customers, Deltana has a Minimum Advertised Price (MAP) policy to protect the market. Advertised prices for all Deltana products must not have a discounted price deeper than 25% off of Deltana's active list price. This policy applies to all advertised prices including, but not limited to, catalogs, printed advertisements, promotional mailers, catalogs, faxes, radio and all electronic media including websites.

Please note that customers are free to sell Deltana products at any price they wish above or below our list price as long as it is not publicly advertised below the discount limit. Specially tailored quotations and/or in-store advertising that are not distributed outside of the store will not be affected by this policy.

In the event that this policy should ever be breached, Deltana reserves the right to discontinue business with that company.

General Limited Warranties

These warranty policies supersede all previously published policies.

GENERAL PRODUCTS:

Deltana products come with a 1-year mechanical warranty that they are free from mechanical defects from date of original purchase when properly installed and used for the purpose specified by Deltana. Deltana does not assume any obligation other than replacement or repair of the defective part or parts upon inspection, along with proof of purchase during the warranty period. Deltana does not assume any responsibility for damage caused by accident, misuse, misapplication, temperature or weather conditions, improper storage, abuse, neglect, improper installation or maintenance. Deltana is also not liable for any labor charges, removal, reinstallation, freight, postage or any damages resulting from any product. Deltana is not liable for any damages caused by mis-preparation of hardware caused by print and/or website materials, line drawings and instruction errors.

STAINLESS STEEL AND PVD FINISHES:

Deltana's PVD (CR003) finish and stainless steel products are warranted for 1 year not to tarnish, discolor, flake, peel, pit, or corrode within normal environmental conditions such as dry environments and air-conditioned interiors. In high moisture and/or salty environments these finishes require maintenance by wiping the product with a clean, damp cloth periodically to remove build-up and sediments from the environment. Neglect of Deltana's recommended maintenance voids product finish warranty.

DOOR CLOSERS:

Deltana door closers come with a 5-year mechanical warranty.

DELTA COMMERCIAL DOOR HARDWARE:

Grade 1 & 2 Commercial Hardware come with a 5-year mechanical and 1-year finish warranty with exception to normal wear and tear.

DELTA RESIDENTIAL DOOR HARDWARE:

Deltana residential hardware comes with a 3-year mechanical and 1-year finish warranty with exception to normal wear and tear. Deltana residential hardware is designed for interior / indoor applications only except for handlesets and deadbolts.

Solid Brass Hinges & Finials

	Pages
About Deltana Solid Brass Hinges.....	1 - 2
Solid Brass Hinges.....	1 - 4
Wide Throw Hinges.....	1 - 7
Solid Brass Finials.....	1 - 7



- Hinges are sold in pairs. Finials are sold per each. 1 pair of hinges requires 4 finials.
- Custom NRP available.
- Custom finish plating available.

SPECIALTY HINGES & FINIALS

Deltana solid brass hinges are available in an array of finishes with superior luster and shine. They are resistant to oxidation and can also be custom-plated in any finish.

Deltana solid brass hinges come standard with button tip finials, stainless steel barrel pins, true solid brass screws and can be upgraded with our beautiful selection of decorative finials.



Hinge Option Codes

CODE	DEFINITION
HD	Heavy Duty Thickness, Architectural Grade
-R	Residential Grade
-RZ	Residential Grade, Zig Zag hole pattern (Non-Template)
STD	Standard Square Corners
NRP	Non-Removable Pin (Security for out-swinging doors)
BB	Ball Bearing
NRP/BB	Non-Removable Pin / Ball Bearing (N/B)
R4	Radius (1/4") Round corners
R5	Radius (5/8") Round corners
UNL	Unlacquered Finish (No clear coat)
FINIALS	Decorative Tips for brass hinges. Available in matching finishes.



Deltana Crown PVD Finish (CR003)

DELTA CROWN PVD finish has the appearance of polished brass but without the ordinary problems of easy tarnishing, discoloration, flaking or pitting commonly associated with a standard polished brass.

DELTA CROWN PVD finish is a titanium PVD process that does not utilize a clear coat.

DELTA CROWN PVD finish is warranted not to tarnish, discolor, flake, peel, pit, or corrode for 1 year.

For high-salt environments, finish must be maintained by wiping with a clean, damp cloth periodically.

Solid Brass Hinge Finishes

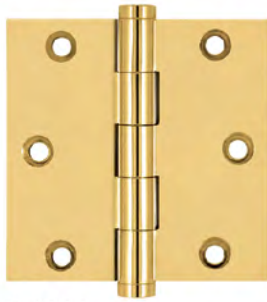

CR003
PVD Polished Brass

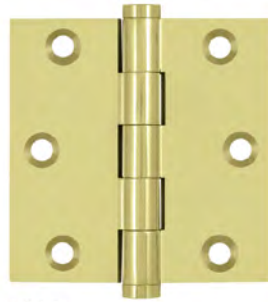

US3
Polished Brass

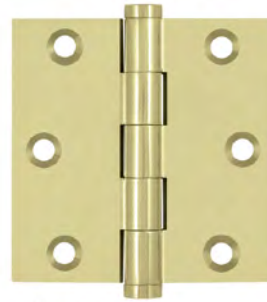

US3-UNL
Unlacquered Brass

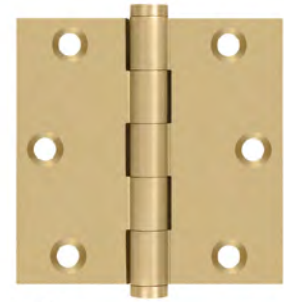

US4
Brushed Brass

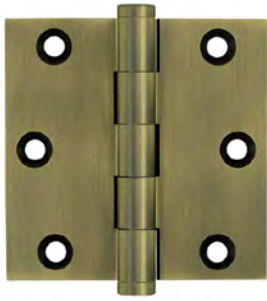

US5
Antique Brass



US10B
Oil-Rubbed Bronze



US14
Polished Nickel



US15
Brushed Nickel



US15A
Antique Nickel



US19
Flat Black



US26
Polished Chrome



US26D
Brushed Chrome

How to Determine the Radius of a Hinge

To determine if you have 1/4" or 5/8" radius corner hinge, measure the beginning of the curve to where the corner of the hinge would be if it were square.

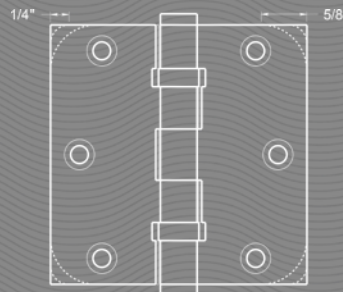

Location of Hinge on the Door

Upper hinge 5" from top jamb to top edge of barrel.

Bottom hinge 10" from bottom edge of barrel to finished floor.

Middle centered between top and bottom hinges.



Check out Deltana's corner chisel tool. See 12 - 4

How to Select the Proper Hinge Size

To choose the proper hinge size consider the following:

Thickness of Door	Width of Door	Height of Hinge
1-3/8" Door	To 32"	3-1/2"
1-3/8" Door	32" to 36"	4"
1-3/4" Door	To 36"	4-1/2"
1-3/4" Door	36" to 48"	5"
1-3/4" Door	Over 48"	6"
2", 2-1/4", 2-1/2" Door	To 42"	5" Commercial
2", 2-1/4", 2-1/2" Door	Over 42"	6" Commercial

Number of Hinges per Door

As a general rule you will want to use 1 hinge per every 30" of door or fraction thereof. Referring to door height:

Doors up to 60" need 2 hinges. Doors over 60" but not over 90" need 3 hinges. Doors over 90" but not over 120" need 4 hinges.

Hinges / Full Mortise / Extruded / Solid Brass

Case price eligibility based on orders of case quantities or more.

3" x 2-1/2" / Square Corner

Part Number	Finish	List Pair	WOOD SCREW #10 x 1"
DSB3025U3	US3	34.00	
DSB3025U3-UNL	US3-UNL	34.00	
DSB3025U10B	US10B	38.00	THICK 0.097"
DSB3025U15	US15	38.00	
DSB3025U19	US19	38.00	CASE QTY 30 PR

Recommended for screen doors.

3-1/2" x 3-1/2" / Square Corner / Ball Bearing

Part Number	Finish	List Pair	WOOD SCREW #10 x 1"
DSB35B3	US3	42.00	
DSB35B3-UNL	US3-UNL	42.00	
DSB35B4	US4	52.00	THICK 0.119"
DSB35B5	US5	52.00	
DSB35B10B	US10B	52.00	
DSB35B14	US14	52.00	CASE QTY 30 PR
DSB35B15	US15	52.00	
DSB35B15A	US15A	52.00	
DSB35B19	US19	52.00	
DSB35B26	US26	52.00	
DSB35B26D	US26D	52.00	
CSB35BB	CR003	64.00	

3" x 3" / Square Corner

Part Number	Finish	List Pair	WOOD SCREW #10 x 1"
DSB33	US3	34.00	
DSB33-UNL	US3-UNL	34.00	
DSB35	US5	43.00	THICK 0.097"
DSB310B	US10B	43.00	
DSB314	US14	43.00	CASE QTY 30 PR
DSB315	US15	43.00	
DSB315A	US15A	43.00	
DSB319	US19	43.00	
DSB326	US26	43.00	
DSB326D	US26D	43.00	
CSB33	CR003	52.00	

3-1/2" x 3-1/2" x 1/4" Radius Corner

Part Number	Finish	List Pair	WOOD SCREW #10 x 1"
DSB35R43	US3	40.00	
DSB35R44	US4	47.00	
DSB35R45	US5	47.00	THICK 0.119"
DSB35R415	US15	47.00	
DSB35R415A	US15A	47.00	
DSB35R426	US26	47.00	CASE QTY 30 PR

3-1/2" x 3-1/2" / Square Corner

Part Number	Finish	List Pair	WOOD SCREW #10 x 1"
DSB353	US3	40.00	
DSB353-UNL	US3-UNL	40.00	
DSB354	US4	47.00	THICK 0.119"
DSB355	US5	47.00	
DSB3510B	US10B	47.00	
DSB3514	US14	47.00	CASE QTY 30 PR
DSB3515	US15	47.00	
DSB3515A	US15A	47.00	
DSB3519	US19	47.00	
DSB3526	US26	47.00	
DSB3526D	US26D	47.00	
CSB35	CR003	61.00	

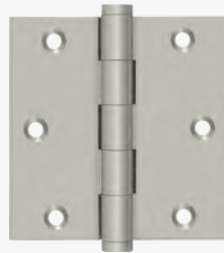
3-1/2" x 3-1/2" x 1/4" Radius Corner / Residential

Part Number	Finish	List Pair	WOOD SCREW #10 x 1"
DSB35R43-R	US3	37.00	
DSB35R45-R	US5	44.00	
DSB35R410B-R	US10B	44.00	THICK 0.085"
DSB35R415-R	US15	44.00	
DSB35R415A-R	US15A	44.00	
DSB35R419-R	US19	44.00	CASE QTY 30 PR
DSB35R426-R	US26	44.00	
DSB35R426D-R	US26D	44.00	
CSB35R4-R	CR003	59.00	

3-1/2" x 3-1/2" / Square Corner / Residential

Part Number	Finish	List Pair	WOOD SCREW #10 x 1"
DSB353-R	US3	37.00	
DSB353-UNL-R	US3-UNL	37.00	
DSB355-R	US5	44.00	THICK 0.085"
DSB3510B-R	US10B	44.00	
DSB3515-R	US15	44.00	
DSB3515A-R	US15A	44.00	CASE QTY 30 PR
DSB3519-R	US19	44.00	
DSB3526-R	US26	44.00	
DSB3526D-R	US26D	44.00	
CSB35-R	CR003	59.00	

3-1/2" x 3-1/2" x 5/8" Radius Corner

Part Number	Finish	List Pair	WOOD SCREW #10 x 1"
DSB35R53	US3	40.00	
DSB35R55	US5	47.00	
DSB35R510B	US10B	47.00	THICK 0.119"
DSB35R514	US14	47.00	
DSB35R515	US15	47.00	
DSB35R515A	US15A	47.00	CASE QTY 30 PR
DSB35R526	US26	47.00	
DSB35R526D	US26D	47.00	
CSB35R5	CR003	61.00	



Hinges / Full Mortise / Extruded / Solid Brass

Case price eligibility based on orders of case quantities or more.

3-1/2" x 3-1/2" x 5/8" Radius Corner / Residential

Part Number	Finish	List Pair	WOOD SCREW #10x1"
DSB35R53-R	US3	37.00	
DSB35R55-R	US5	44.00	
DSB35R510B-R	US10B	44.00	
DSB35R514-R	US14	44.00	
DSB35R515-R	US15	44.00	
DSB35R515A-R	US15A	44.00	
DSB35R519-R	US19	44.00	
DSB35R526-R	US26	44.00	
DSB35R526D-R	US26D	44.00	
CSB35R5-R	CR003	59.00	



4" x 4" / Square Corner / Ball Bearing / NRP

Part Number	Finish	List Pair	WOOD SCREW #12x1-1/4"
DSB4NB3	US3	57.00	
DSB4NB5	US5	73.00	
DSB4NB10B	US10B	73.00	
DSB4NB15	US15	73.00	
DSB4NB15A	US15A	73.00	
DSB4NB19	US19	73.00	
DSB4NB26	US26	73.00	
DSB4NB26D	US26D	73.00	
CSB44BN	CR003	88.00	



Non-Removable Pin

4" x 4" / Square Corner

Part Number	Finish	List Pair	WOOD SCREW #12x1-1/4"
DSB43	US3	43.00	
DSB43-UNL	US3-UNL	43.00	
DSB44	US4	56.00	
DSB45	US5	56.00	
DSB410B	US10B	56.00	
DSB414	US14	56.00	
DSB415	US15	56.00	
DSB415A	US15A	56.00	
DSB419	US19	56.00	
DSB426	US26	56.00	
DSB426D	US26D	56.00	
CSB44	CR003	77.00	

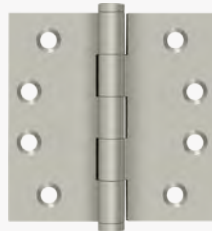

4" x 4" / Square Corner / Zig Zag / Residential

Part Number	Finish	List Pair	WOOD SCREW #10x1"
DSB43-RZ	US3	41.00	
DSB410B-RZ	US10B	52.00	
DSB415-RZ	US15	52.00	
DSB426-RZ	US26	52.00	



4" x 4" / Square Corner / NRP

Part Number	Finish	List Pair	WOOD SCREW #12x1-1/4"
DSB4N3	US3	46.00	
DSB4N5	US5	60.00	
DSB4N10B	US10B	60.00	
DSB4N26	US26	60.00	
DSB4N26D	US26D	60.00	
CSB44N	CR003	81.00	



Non-Removable Pin

4" x 4" x 1/4" Radius Corner / Zig Zag / Residential

Part Number	Finish	List Pair	WOOD SCREW #10x1"
DSB4R43-RZ	US3	41.00	
DSB4R45-RZ	US5	52.00	
DSB4R410B-RZ	US10B	52.00	
DSB4R415-RZ	US15	52.00	
DSB4R415A-RZ	US15A	52.00	
DSB4R419-RZ	US19	52.00	
DSB4R426-RZ	US26	52.00	
DSB4R426D-RZ	US26D	52.00	
CSB44R4-RZ	CR003	68.00	



4" x 4" / Square Corner / Ball Bearing

Part Number	Finish	List Pair	WOOD SCREW #12x1-1/4"
DSB4B3	US3	46.00	
DSB4B3-UNL	US3-UNL	46.00	
DSB4B4	US4	62.00	
DSB4B5	US5	62.00	
DSB4B10B	US10B	62.00	
DSB4B14	US14	62.00	
DSB4B15	US15	62.00	
DSB4B15A	US15A	62.00	
DSB4B19	US19	62.00	
DSB4B26	US26	62.00	
DSB4B26D	US26D	62.00	
CSB44BB	CR003	85.00	



4" x 4" x 5/8" Radius Corner

Part Number	Finish	List Pair	WOOD SCREW #10x1"
DSB4R53-R	US3	41.00	
DSB4R515-R	US15	52.00	
DSB4R5N10B	US10B	60.00	
DSB4R5N15	US15	60.00	

Residential



Hinges / Full Mortise / Extruded / Solid Brass

Case price eligibility based on orders of case quantities or more.

4"x 4" / 5/8" Radius Corner

Part Number	Finish	List Pair	WOOD SCREW #12x1-1/4"
DSB4R53	US3	43.00	
DSB4R55	US5	56.00	
DSB4R510B	US10B	56.00	THICK 0.129"
DSB4R515	US15	56.00	
DSB4R515A	US15A	56.00	
DSB4R526	US26	56.00	
DSB4R526D	US26D	56.00	
CSB44R5	CR003	77.00	CASE QTY 30 PR



4"x 4" / 5/8" Radius Corner / Zig Zag / Residential

Part Number	Finish	List Pair	WOOD SCREW #10x1"
DSB4R53-RZ	US3	41.00	
DSB4R55-RZ	US5	52.00	
DSB4R510B-RZ	US10B	52.00	THICK 0.085"
DSB4R514-RZ	US14	52.00	
DSB4R515-RZ	US15	52.00	
DSB4R515A-RZ	US15A	52.00	
DSB4R519-RZ	US19	52.00	
DSB4R526-RZ	US26	52.00	
DSB4R526D-RZ	US26D	52.00	
CSB44R5-RZ	CR003	68.00	CASE QTY 30 PR



4-1/2"x 4-1/2" / Square Corner

Part Number	Finish	List Pair	WOOD SCREW #12x1-1/4"
DSB453	US3	65.00	
DSB453-UNL	US3-UNL	65.00	
DSB455	US5	73.00	
DSB4510B	US10B	73.00	MACHINE SCREW #12x1/2"
DSB4514	US14	73.00	
DSB4515	US15	73.00	
DSB4515A	US15A	73.00	THICK 0.134"
DSB4519	US19	73.00	
DSB4526	US26	73.00	
DSB4526D	US26D	73.00	
CSB45	CR003	103.00	CASE QTY 20 PR



4-1/2"x 4-1/2" / Square Corner / Ball Bearing

Part Number	Finish	List Pair	WOOD SCREW #12x1-1/4"
DSB45B3	US3	69.00	
DSB45B3-UNL	US3-UNL	69.00	
DSB45B4	US4	88.00	
DSB45B5	US5	88.00	MACHINE SCREW #12x1/2"
DSB45B10B	US10B	88.00	
DSB45B14	US14	88.00	
DSB45B15	US15	88.00	THICK 0.134"
DSB45B15A	US15A	88.00	
DSB45B26	US26	88.00	
DSB45B26D	US26D	88.00	
CSB45BB	CR003	114.00	CASE QTY 20 PR

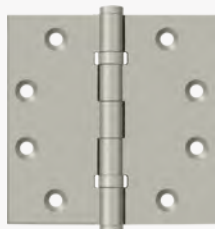

4 1/2"x 4 1/2" / Square Corner / Ball Bearing / NRP

Part Number	Finish	List Pair	WOOD SCREW #12x1-1/4"
DSB45NB3	US3	77.00	
DSB45NB3-UNL	US3-UNL	77.00	
DSB45NB5	US5	94.00	
DSB45NB10B	US10B	94.00	MACHINE SCREW #12x1-1/2"
DSB45NB14	US14	94.00	
DSB45NB15	US15	94.00	
DSB45NB15A	US15A	94.00	THICK 0.134"
DSB45NB19	US19	94.00	
DSB45NB26	US26	94.00	
DSB45NB26D	US26D	94.00	
CSB45BN	CR003	119.00	CASE QTY 20 PR



Non-Removable Pin

5"x 5" / Square Corner / Ball Bearing

Part Number	Finish	List Pair	WOOD SCREW #12x1-1/4"
DSB55B3	US3	118.00	
DSB55B3-UNL	US3-UNL	118.00	
DSB55B5	US5	126.00	
DSB55B10B	US10B	126.00	MACHINE SCREW #12x1/2"
DSB55B14	US14	126.00	
DSB55B15	US15	126.00	
DSB55B15A	US15A	126.00	THICK 0.145"
DSB55B26	US26	126.00	
DSB55B26D	US26D	126.00	
CSB55BB	CR003	150.00	CASE QTY 20 PR



5"x 5" / Square Corner / Ball Bearing / NRP

Part Number	Finish	List Pair	WOOD SCREW #12x1-1/4"
DSB55NB3	US3	130.00	
DSB55NB3-UNL	US3-UNL	130.00	
DSB55NB5	US5	142.00	
DSB55NB10B	US10B	142.00	MACHINE SCREW #12x1/2"
DSB55NB15	US15	142.00	
DSB55NB15A	US15A	142.00	THICK 0.145"
DSB55NB19	US19	142.00	
DSB55NB26	US26	142.00	
DSB55NB26D	US26D	142.00	
CSB55BN	CR003	160.00	CASE QTY 20 PR



Non-Removable Pin

5"x 5" / Square Corner

Part Number	Finish	List Pair	WOOD SCREW #12x1-1/4"
DSB553-UNL	US3-UNL	110.00	
DSB5510B	US10B	118.00	
DSB5514	US14	118.00	
DSB5515	US15	118.00	MACHINE SCREW #12x1/2"
			THICK 0.145"
			CASE QTY 20 PR



6"x 6" / Square Corner / Ball Bearing

Part Number	Finish	List Pair	WOOD SCREW #14x1-1/2"
DSB66BB3	US3	174.00	
DSB66BB3-UNL	US3-UNL	174.00	
DSB66BB5	US5	188.00	
DSB66BB10B	US10B	188.00	THICK 0.205"
DSB66BB15A	US15A	188.00	
DSB66BB26	US26	188.00	
DSB66BB26D	US26D	188.00	
CSB66BB	CR003	194.00	CASE QTY 8 PR



Optional extra large ball tip finials (DSBTL) are available for 6"x 6". See 1-7.

Hinges / Full Mortise / Extruded / Solid Brass

Case price eligibility based on orders of case quantities or more.

Wide Throw Hinges

Part Number	Finish	Open Size	Corners	Options	Thickness	M Screw	Case Weight	List Pair	WOOD SCREW #12x1-1/4"
DSB406010B	US10B	4"x 6"	Square	Standard	0.129"	#12 x 1/2"	52 LB	98.00	
DSB4560BB10B	US10B	4 1/2"x 6"	Square	4BB	0.137"	#12 x 1/2"	52 LB	120.00	
DSB4045U10B	US10B	4"x 4 1/2"	Square	Standard	0.134"	#12 x 1/2"	40 LB	88.00	
CSB4540SN	CR003	4 1/2"x 4"	Square	3 Knuckle/NRP	0.134"	#12 x 1/2"	46 LB	105.00	
CSB4560BB	CR003	4 1/2"x 6"	Square	4BB	0.137"	#12 x 1/2"	56 LB	150.00	
DSB4540NBW	White	4 1/2"x 4"	1/4"	NRP/2BB	0.118"	NA	42 LB	100.00	



Finials / Solid Brass

Acorn Tip

Part Number	Finish	List Each	HEIGHT
DSAT3	US3	3.90	7/8"
DSAT3-UNL	US3-UNL	3.90	
DSAT5	US5	3.90	1/2"
DSAT10B	US10B	3.90	
DSAT14	US14	3.90	
DSAT15	US15	3.90	THREAD 8 x 1.25 mm
DSAT15A	US15A	3.90	
DSAT19	US19	3.90	
DSAT26	US26	3.90	
DSAT26D	US26D	3.90	
CAT1	CR003	5.00	



Ball Tip

Part Number	Finish	List Each	HEIGHT
DSBT3	US3	3.90	9/16"
DSBT3-UNL	US3-UNL	3.90	
DSBT4	US4	3.90	1/2"
DSBT5	US5	3.90	
DSBT10B	US10B	3.90	
DSBT14	US14	3.90	THREAD 8 x 1.25 mm
DSBT15	US15	3.90	
DSBT15A	US15A	3.90	
DSBT19	US19	3.90	
DSBT26	US26	3.90	
DSBT26D	US26D	3.90	
CBT1	CR003	5.00	



Steeple Tip

Part Number	Finish	List Each	HEIGHT
DSST3	US3	3.90	1 3/16"
DSST3-UNL	US3-UNL	3.90	
DSST5	US5	3.90	
DSST10B	US10B	3.90	1/2"
DSST14	US14	3.90	
DSST15	US15	3.90	
DSST15A	US15A	3.90	THREAD 8 x 1.25 mm
DSST19	US19	3.90	
DSST26	US26	3.90	
DSST26D	US26D	3.90	
CST1	CR003	5.00	



Windsor Tip

Part Number	Finish	List Each	HEIGHT
DSWT3	US3	3.90	1 1/4"
DSWT3-UNL	US3-UNL	3.90	
DSWT4	US4	3.90	
DSWT5	US5	3.90	1/2"
DSWT10B	US10B	3.90	
DSWT15	US15	3.90	
DSWT15A	US15A	3.90	THREAD 8 x 1.25 mm
DSWT19	US19	3.90	
DSWT26	US26	3.90	
DSWT26D	US26D	3.90	
CWT1	CR003	5.00	



Urn Tip

Part Number	Finish	List Each	HEIGHT
DSUT3	US3	3.90	1 3/8"
DSUT3-UNL	US3-UNL	3.90	
DSUT4	US4	3.90	
DSUT5	US5	3.90	1/2"
DSUT10B	US10B	3.90	
DSUT14	US14	3.90	
DSUT15	US15	3.90	THREAD 8 x 1.25 mm
DSUT15A	US15A	3.90	
DSUT19	US19	3.90	
DSUT26	US26	3.90	
DSUT26D	US26D	3.90	
CUT1	CR003	5.00	



Ornate Pattern Tip

Part Number	Finish	List Each	HEIGHT
DSPUT3	US3	5.10	1 7/16"
DSPUT3-UNL	US3-UNL	5.10	
DSPUT5	US5	5.10	
DSPUT10B	US10B	5.10	5/8"
DSPUT15	US15	5.10	
DSPUT15A	US15A	5.10	THREAD 8 x 1.25 mm
DSPUT26	US26	5.10	
DSPUT26D	US26D	5.10	
CPUT	CR003	6.50	



Large Ball Tip for 6"x 6" Hinges

Part Number	Finish	List Each	HEIGHT
DSBTL3	US3	5.10	3/4"
DSBTL3-UNL	US3-UNL	5.10	
DSBTL5	US5	5.10	
DSBTL10B	US10B	5.10	5/8"
DSBTL15	US15	5.10	
DSBTL15A	US15A	5.10	THREAD 10 x 1 mm
DSBTL26	US26	5.10	
DSBTL26D	US26D	5.10	
DSBTL003	CR003	6.50	

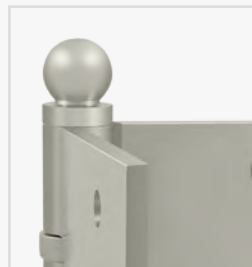

About our Finials

All Deltana standard decorative finials are available in matching finishes and fit best on our hinges sized 3-1/2"x 3-1/2" ~ 5"x 5". They can be installed interchangeably on all Deltana solid brass door hinges except for 6"x 6" hinges, which have their own part number "DSBTL"



DSBU

Note: You need 4 finials for every pair of hinges.

Additional button tips are available. See Section 12 - 4.

Specialty Solid Brass Hinges & Finials

	Pages
Ornate Hinges & Finials.....	2 - 2
Distressed Hinges.....	2 - 3
Distressed Finials.....	2 - 4
Heavy Duty Hinges - Royal Series.....	2 - 4
Royal Finials: for DSB45RM Series.....	2 - 4
Olive Knuckle Hinges.....	2 - 5
Cabinet Hinges.....	2 - 7
Half Surface Hinges.....	2 - 8
Cabinet Finials.....	2 - 8
Pivot Hinges.....	2 - 9
Pivot Base.....	2 - 9
Parliament Hinges.....	2 - 10
Invisible, Concealed Hinges.....	2 - 10

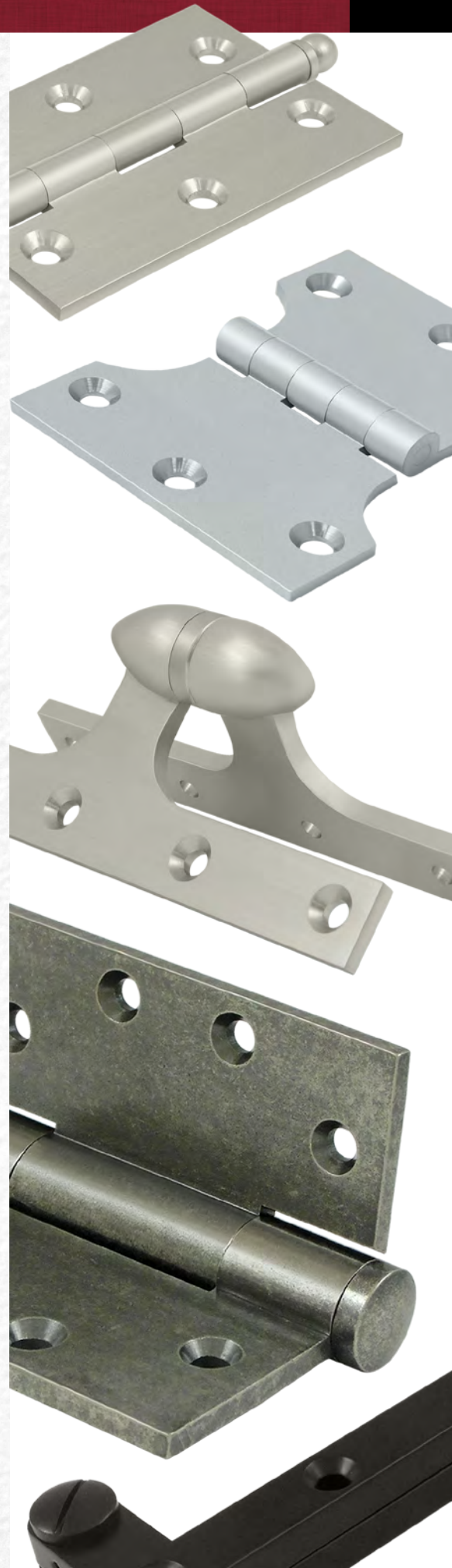

- ▣ Finials are sold per each. 1 pair of hinges requires 4 finials.
- ▣ Olive Knuckle Hinges are sold per each.
- ▣ Custom NRP available.
- ▣ Custom finish plating available.

SPECIALTY HINGES & FINIALS

ORNATE HINGES

4"x 4" and 4-1/2"x 4-1/2" designs come with ornamentation on the front and back as shown.

3-1/2" design comes with 5-knuckle and with ornamentation on the front as shown.

Slot-head screws and ornate finials are included.



Ornate Hinges / Solid Brass

3 1/2"x 3 1/2" Ornate

Part Number	Finish	List Price Pair	WOOD SCREW #10x1"
DSBP35U3	US3	74.00	THICK 0.150"
DSBP35U3-UNL	US3-UNL	74.00	
DSBP35U5	US5	80.00	CASE QTY 30 PR
DSBP35U10B	US10B	80.00	
DSBP35U15	US15	80.00	
DSBP35U15A	US15A	80.00	
DSBP35U26	US26	80.00	
DSBP35U26D	US26D	80.00	
CSBP35	CR003	92.00	

5-knuckles



4"x 4" Ornate

Part Number	Finish	List Price Pair	WOOD SCREW #12x1"
DSBP44U3	US3	85.00	THICK 0.168"
DSBP44U3-UNL	US3-UNL	85.00	
DSBP44U5	US5	92.00	CASE QTY 30 PR
DSBP44U10B	US10B	92.00	
DSBP44U15	US15	92.00	
DSBP44U15A	US15A	92.00	
DSBP44U26	US26	92.00	
DSBP44U26D	US26D	92.00	
CSBP44	CR003	104.00	

3-knuckles



4 1/2"x 4 1/2" Ornate

Part Number	Finish	List Price Pair	WOOD SCREW #12x1"
DSBP45U3	US3	116.00	THICK 0.168"
DSBP45U3-UNL	US3-UNL	116.00	
DSBP45U5	US5	124.00	CASE QTY 20 PR
DSBP45U10B	US10B	124.00	
DSBP45U15	US15	124.00	
DSBP45U15A	US15A	124.00	
DSBP45U19	US19	124.00	
DSBP45U26	US26	124.00	
DSBP45U26D	US26D	124.00	
CSBP45	CR003	142.00	

3-knuckles



Ornate Finial

Part Number	Finish	List Price Pair	HEIGHT 1 7/16"
DSPUT3	US3	5.10	5/8"
DSPUT3-UNL	US3-UNL	5.10	
DSPUT5	US5	5.10	THREAD 8 x 1.25 mm
DSPUT10B	US10B	5.10	
DSPUT15	US15	5.10	
DSPUT15A	US15A	5.10	
DSPUT26	US26	5.10	
DSPUT26D	US26D	5.10	
CPUT	CR003	6.50	

All ornate hinges already come with ornate finials installed.



Distressed Finish Hinges / Solid Brass

BD

BM

BR

WL

WM

RT

WD



3 1/2" x 3 1/2" x 1/4" Radius Corner Residential

Part Number	Finish	List Price Pair	WOOD SCREW #10x1"
DSB35R4RT-R	RT	48.00	THICK 0.085"
DSB35R410BM-R	BM	48.00	
DSB35R410BD-R	BD	48.00	CASE QTY 30 PR
DSB35R410BR-R	BR	48.00	
DSB35R410WL-R	WL	48.00	
DSB35R410WD-R	WD	48.00	



RT

4" x 4" / Square Corner / NRP

Part Number	Finish	List Price Pair	WOOD SCREW #12x1 1/4"
DSB4NRT	RT	75.00	THICK 0.129"
DSB4N10BM	BM	75.00	
DSB4N10BD	BD	75.00	CASE QTY 30 PR
DSB4N10BR	BR	75.00	
DSB4N10WM	WM	75.00	
DSB4N10WD	WD	75.00	



BM

Non removable pin.

3 1/2" x 3 1/2" x 5/8" Radius Corner Residential

Part Number	Finish	List Price Pair	WOOD SCREW #10x1"
DSB35R510BM-R	BM	48.00	THICK 0.085"
DSB35R510BD-R	BD	48.00	
DSB35R510BR-R	BR	48.00	CASE QTY 30 PR
DSB35R510WL-R	WL	48.00	
DSB35R510WM-R	WM	48.00	
DSB35R510WD-R	WD	48.00	



WM

4" x 4" / Square Corner / Ball Bearing / NRP

Part Number	Finish	List Price Pair	WOOD SCREW #12x1 1/4"
DSB4NB10BM	BM	85.00	THICK 0.129"
DSB4NB10BD	BD	85.00	
DSB4NB10WL	WL	85.00	CASE QTY 30 PR
DSB4NB10WM	WM	85.00	
DSB4NB10WD	WD	85.00	



WM

Non-removable pin.

3 1/2" x 3 1/2" / Square Corner

Part Number	Finish	List Price Pair	WOOD SCREW #10x1"
DSB35RT	RT	53.00	THICK 0.119"
DSB3510BM	BM	53.00	
DSB3510BD	BD	53.00	CASE QTY 30 PR
DSB3510BR	BR	53.00	
DSB3510WL	WL	53.00	
DSB3510WM	WM	53.00	
DSB3510WD	WD	53.00	



WD

4 1/2" x 4 1/2" / Square Corner

Part Number	Finish	List Price Pair	WOOD SCREW #12x1 1/4"
DSB45RT	RT	90.00	THICK 0.129"
DSB4510BM	BM	90.00	
DSB4510BD	BD	90.00	CASE QTY 20 PR
DSB4510BR	BR	90.00	
DSB4510WL	WL	90.00	
DSB4510WM	WM	90.00	
DSB4510WD	WD	90.00	



BR

4" x 4" / Square Corner

Part Number	Finish	List Price Pair	WOOD SCREW #12x1 1/4"
DSB410BM	BM	69.00	THICK 0.129"
DSB410BD	BD	69.00	
DSB410BR	BR	69.00	CASE QTY 30 PR
DSB410WL	WL	69.00	
DSB410WM	WM	69.00	
DSB410WD	WD	69.00	



WL

4 1/2" x 4 1/2" / Square Corner Ball Bearing / NRP

Part Number	Finish	List Price Pair	WOOD SCREW #12x1 1/4"
DSB45NBRT	RT	104.00	THICK 0.135"
DSB45NB10BM	BM	104.00	
DSB45NB10BD	BD	104.00	CASE QTY 20 PR
DSB45NB10BR	BR	104.00	
DSB45NB10WL	WL	104.00	
DSB45NB10WM	WM	104.00	
DSB45NB10WD	WD	104.00	



BD

Non-removable pin.

Distressed Finish Finials / Royal Series Hinges & Finials / Solid Brass

Ball Tip

Part Number	Finish	List Price Each	HEIGHT 9/16"
DSBTRT	RT	4.20	1/2"
DSBT10BM	BM	4.20	
DSBT10BD	BD	4.20	8 x 1.25 mm
DSBT10BR	BR	4.20	
DSBT10WL	WL	4.20	
DSBT10WM	WM	4.20	
DSBT10WD	WD	4.20	



DSBT10-WM

Steeple Tip

Part Number	Finish	List Price Each	HEIGHT 1 3/16"
DSSTRT	RT	4.20	1/2"
DSST10BM	BM	4.20	
DSST10BD	BD	4.20	8 x 1.25 mm
DSST10BR	BR	4.20	
DSST10WL	WL	4.20	
DSST10WM	WM	4.20	
DSST10WD	WD	4.20	



DSST10-BM

Urn Tip

Part Number	Finish	List Price Each	HEIGHT 1 3/8"
DSUTRT	RT	4.20	1/2"
DSUT10BM	BM	4.20	
DSUT10BD	BD	4.20	8 x 1.25 mm
DSUT10BR	BR	4.20	
DSUT10WL	WL	4.20	
DSUT10WM	WM	4.20	
DSUT10WD	WD	4.20	



DSUT10-BD

Royal Series Hinges & Finials / Solid Brass

4 1/2"x 4 1/2" / Extra Heavy Duty

Part Number	Finish	List Price Pair	WOOD SCREW #12x1 1/4"
DSB45RM5	US5	154.00	THICK 0.2"
DSB45RM10B	US10B	154.00	
DSB45RM10BM	BM	154.00	CASE QTY 20 PR
DSB45RM10BD	BD	154.00	
DSB45RM10BR	BR	154.00	
DSB45RM10WL	WL	154.00	
DSB45RM10WM	WM	154.00	
DSB45RM10WD	WD	154.00	



DSB45RM10WM

Royal Finial / For DSB45RM

Part Number	Finish	List Price Each	HEIGHT 3"
DSFRU5	US5	9.85	7/8"
DSFRU10B	US10B	9.85	
DSFRU10BD	BD	9.85	14 x 2 mm
DSFRU10BR	BR	9.85	
DSFRU10WL	WL	9.85	
DSFRU10WM	WM	9.85	
DSFRU15	US15	9.85	
DSFRU003	CR003	9.85	

Royal finials sold separately.



DSFRU15

Distressed Finishes

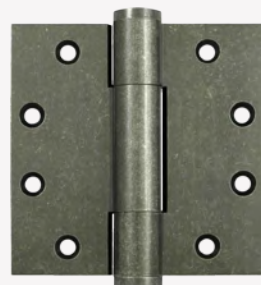
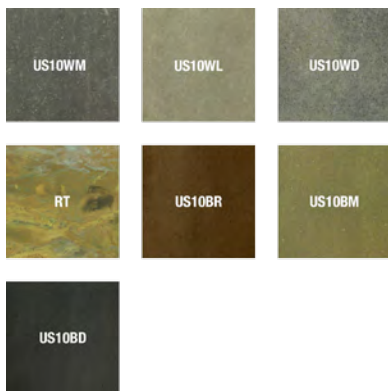

Olive Knuckle Hinges / Solid Brass / Full Mortise / Extruded

2"x 1 1/2" / Right Handed

Part Number	Finish	List Price Each	WOOD SCREW #7x3/4"
OK2015U3-R	US3	30.00	BOX QTY 4 EA
OK2015U3UNL-R	US3-UNL	30.00	
OK2015U5-R	US5	38.00	
OK2015U10B-R	US10B	38.00	
OK2015U15-R	US15	38.00	
OK2015U15A-R	US15A	38.00	
OK2015U19-R	US19	38.00	
OK2015U26-R	US26	38.00	
OK2015U26D-R	US26D	38.00	
OK2015CR003-R	CR003	48.00	



2"x 1 1/2" / Left Handed

Part Number	Finish	List Price Each	WOOD SCREW #7x3/4"
OK2015U3-L	US3	30.00	BOX QTY 4 EA
OK2015U3UNL-L	US3-UNL	30.00	
OK2015U5-L	US5	38.00	
OK2015U10B-L	US10B	38.00	
OK2015U15-L	US15	38.00	
OK2015U15A-L	US15A	38.00	
OK2015U19-L	US19	38.00	
OK2015U26-L	US26	38.00	
OK2015U26D-L	US26D	38.00	
OK2015CR003-L	CR003	48.00	



2 1/2"x 2" / Right Handed

Part Number	Finish	List Price Each	WOOD SCREW #7x3/4"
OK2520U3-R	US3	37.00	BOX QTY 4 EA
OK2520U3UNL-R	US3-UNL	37.00	
OK2520U5-R	US5	45.00	
OK2520U10B-R	US10B	45.00	
OK2520U14-R	US14	45.00	
OK2520U15-R	US15	45.00	
OK2520U15A-R	US15A	45.00	
OK2520U19-R	US19	45.00	
OK2520U26-R	US26	45.00	
OK2520U26D-R	US26D	45.00	
OK2520CR003-R	CR003	60.00	



2 1/2"x 2" / Left Handed

Part Number	Finish	List Price Each	WOOD SCREW #7x3/4"
OK2520U3-L	US3	37.00	BOX QTY 4 EA
OK2520U3UNL-L	US3-UNL	37.00	
OK2520U5-L	US5	45.00	
OK2520U10B-L	US10B	45.00	
OK2520U14-L	US14	45.00	
OK2520U15-L	US15	45.00	
OK2520U15A-L	US15A	45.00	
OK2520U19-L	US19	45.00	
OK2520U26-L	US26	45.00	
OK2520U26D-L	US26D	45.00	
OK2520CR003-L	CR003	60.00	



3"x 2 1/2" / Right Handed

Part Number	Finish	List Price Each	WOOD SCREW #10x1"
OK3025B3-R	US3	56.00	BOX QTY 2 EA
OK3025B3UNL-R	US3-UNL	56.00	
OK3025B5-R	US5	65.00	
OK3025B10B-R	US10B	65.00	
OK3025B14-R	US14	65.00	
OK3025B15-R	US15	65.00	
OK3025B15A-R	US15A	65.00	
OK3025B19-R	US19	65.00	
OK3025B26-R	US26	65.00	
OK3025B26D-R	US26D	65.00	
OK3025BCR003-R	CR003	82.00	



3"x 2 1/2" / Left Handed

Part Number	Finish	List Price Each	WOOD SCREW #10x1"
OK3025B3-L	US3	56.00	BOX QTY 2 EA
OK3025B3UNL-L	US3-UNL	56.00	
OK3025B5-L	US5	65.00	
OK3025B10B-L	US10B	65.00	
OK3025B14-L	US14	65.00	
OK3025B15-L	US15	65.00	
OK3025B15A-L	US15A	65.00	
OK3025B19-L	US19	65.00	
OK3025B26-L	US26	65.00	
OK3025B26D-L	US26D	65.00	
OK3025BCR003-L	CR003	82.00	

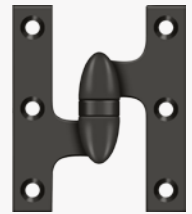

5"x 3 1/4" / Right Handed

Part Number	Finish	List Price Each	WOOD SCREW #10x1"
OK5032B3-R	US3	97.00	BOX QTY 2 EA
OK5032B3UNL-R	US3-UNL	97.00	
OK5032B5-R	US5	113.00	
OK5032B10B-R	US10B	113.00	
OK5032B14-R	US14	113.00	
OK5032B15-R	US15	113.00	
OK5032B15A-R	US15A	113.00	
OK5032B19-R	US19	113.00	
OK5032B26-R	US26	113.00	
OK5032B26D-R	US26D	113.00	
OK5032BCR003-R	CR003	146.00	



5"x 3 1/4" / Left Handed

Part Number	Finish	List Price Each	WOOD SCREW #10x1"
OK5032B3-L	US3	97.00	BOX QTY 2 EA
OK5032B3UNL-L	US3-UNL	97.00	
OK5032B5-L	US5	113.00	
OK5032B10B-L	US10B	113.00	
OK5032B14-L	US14	113.00	
OK5032B15-L	US15	113.00	
OK5032B15A-L	US15A	113.00	
OK5032B19-L	US19	113.00	
OK5032B26-L	US26	113.00	
OK5032B26D-L	US26D	113.00	
OK5032BCR003-L	CR003	146.00	



Olive Knuckle Hinges / Solid Brass / Full Mortise / Extruded

6"x 4" / Right Handed

Part Number	Finish	List Price Each	WOOD SCREW #12x1 1/4"
OK6040B3-R	US3	119.00	BOX QTY 1 EA
OK6040B3UNL-R	US3-UNL	119.00	
OK6040B5-R	US5	135.00	
OK6040B10B-R	US10B	135.00	
OK6040B14-R	US14	135.00	
OK6040B15-R	US15	135.00	
OK6040B15A-R	US15A	135.00	
OK6040B19-R	US19	135.00	
OK6040B26-R	US26	135.00	
OK6040B26D-R	US26D	135.00	
OK6040BCR003-R	CR003	178.00	

6"x 5" / Right Handed

Part Number	Finish	List Price Each	WOOD SCREW #12x1 1/4"
OK6050B3-R	US3	136.00	BOX QTY 1 EA
OK6050B3UNL-R	US3-UNL	136.00	
OK6050B5-R	US5	152.00	
OK6050B10B-R	US10B	152.00	
OK6050B15-R	US15	152.00	
OK6050B15A-R	US15A	152.00	
OK6050B19-R	US19	152.00	
OK6050B26-R	US26	152.00	
OK6050B26D-R	US26D	152.00	
OK6050BCR003-R	CR003	199.00	

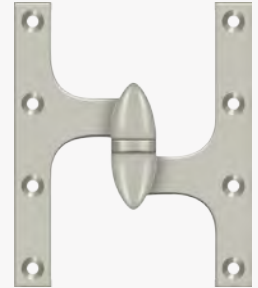
6"x 4" / Left Handed

Part Number	Finish	List Price Each	WOOD SCREW #12x1 1/4"
OK6040B3-L	US3	119.00	BOX QTY 1 EA
OK6040B3UNL-L	US3-UNL	119.00	
OK6040B5-L	US5	135.00	
OK6040B10B-L	US10B	135.00	
OK6040B14-L	US14	135.00	
OK6040B15-L	US15	135.00	
OK6040B15A-L	US15A	135.00	
OK6040B19-L	US19	135.00	
OK6040B26-L	US26	135.00	
OK6040B26D-L	US26D	135.00	
OK6040BCR003-L	CR003	178.00	

6"x 5" / Left Handed

Part Number	Finish	List Price Each	WOOD SCREW #12x1 1/4"
OK6050B3-L	US3	136.00	BOX QTY 1 EA
OK6050B3UNL-L	US3-UNL	136.00	
OK6050B5-L	US5	152.00	
OK6050B10B-L	US10B	152.00	
OK6050B15-L	US15	152.00	
OK6050B15A-L	US15A	152.00	
OK6050B19-L	US19	152.00	
OK6050B26-L	US26	152.00	
OK6050B26D-L	US26D	152.00	
OK6050BCR003-L	CR003	199.00	

6"x 4 1/2" / Right Handed

Part Number	Finish	List Price Each	WOOD SCREW #12x1 1/4"
OK6045B3-R	US3	130.00	BOX QTY 1 EA
OK6045B3UNL-R	US3-UNL	130.00	
OK6045B5-R	US5	147.00	
OK6045B10B-R	US10B	147.00	
OK6045B15-R	US15	147.00	
OK6045B15A-R	US15A	147.00	
OK6045B19-R	US19	147.00	
OK6045B26-R	US26	147.00	
OK6045B26D-R	US26D	147.00	
OK6045BCR003-R	CR003	190.00	

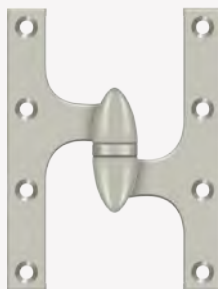
6"x 4 1/2" / Left Handed

Part Number	Finish	List Price Each	WOOD SCREW #12x1 1/4"
OK6045B3-L	US3	130.00	BOX QTY 1 EA
OK6045B3UNL-L	US3-UNL	130.00	
OK6045B5-L	US5	147.00	
OK6045B10B-L	US10B	147.00	
OK6045B15-L	US15	147.00	
OK6045B15A-L	US15A	147.00	
OK6045B19-L	US19	147.00	
OK6045B26-L	US26	147.00	
OK6045B26D-L	US26D	147.00	
OK6045BCR003-L	CR003	190.00	



Cabinet Hinges / Solid Brass / Full Mortise / Extruded

1 1/2" x 1 1/2"

Part Number	Finish	List Price Pair	THICK 0.093"
CH1515U3-UNL	US3-UNL	20.00	BOX QTY 6 PR
CH1515U3	US3	20.00	
CH1515U5	US5	24.00	
CH1515U10B	US10B	24.00	CASE QTY 210 PR
CH1515U14	US14	24.00	
CH1515U15	US15	24.00	
CH1515U15A	US15A	24.00	WOOD SCREW #7 x 3/4"
CH1515U26	US26	24.00	
CH1515U26D	US26D	24.00	
CH1515CR003	CR003	27.00	



2" x 1 1/2"

Part Number	Finish	List Price Pair	THICK 0.093"
CH2015U3-UNL	US3-UNL	20.00	BOX QTY 6 PR
CH2015U3	US3	20.00	
CH2015U5	US5	24.00	
CH2015U10B	US10B	24.00	CASE QTY 210 PR
CH2015U14	US14	24.00	
CH2015U15	US15	24.00	
CH2015U15A	US15A	24.00	WOOD SCREW #7 x 3/4"
CH2015U26	US26	24.00	
CH2015U26D	US26D	24.00	
CH2015CR003	CR003	28.00	



2" x 2"

Part Number	Finish	List Price Pair	THICK 0.093"
CH2020U3-UNL	US3-UNL	22.80	BOX QTY 3 PR
CH2020U3	US3	22.80	
CH2020U5	US5	26.00	
CH2020U10B	US10B	26.00	CASE QTY 100 PR
CH2020U14	US14	26.00	
CH2020U15	US15	26.00	
CH2020U15A	US15A	26.00	WOOD SCREW #7 x 3/4"
CH2020U26	US26	26.00	
CH2020U26D	US26D	26.00	
CH2020CR003	CR003	30.00	



2 1/2" x 1 11/16"

Part Number	Finish	List Price Pair	THICK 0.093"
CH2517U3-UNL	US3-UNL	24.00	BOX QTY 3 PR
CH2517U3	US3	24.00	
CH2517U5	US5	28.00	
CH2517U10B	US10B	28.00	CASE QTY 100 PR
CH2517U14	US14	28.00	
CH2517U15	US15	28.00	
CH2517U15A	US15A	28.00	WOOD SCREW #7 x 3/4"
CH2517U26	US26	28.00	
CH2517U26D	US26D	28.00	
CH2517CR003	CR003	32.00	



All Solid Brass Cabinet Hinges come standard with ball-tip finials.

2 1/2" x 1 11/16" / Adjustable

Part Number	Finish	List Price Pair	THICK 0.093"
CHA2517U3	US3	24.00	BOX QTY 3 PR
CHA2517U3-UNL	US3-UNL	24.00	
CHA2517U5	US5	28.00	
CHA2517U10B	US10B	28.00	CASE QTY 100 PR
CHA2517U14	US14	28.00	
CHA2517U15	US15	28.00	
CHA2517U26	US26	28.00	WOOD SCREW #7 x 3/4"



2 1/2" x 2"

Part Number	Finish	List Price Pair	THICK 0.093"
CH2520U3-UNL	US3-UNL	27.70	BOX QTY 3 PR
CH2520U3	US3	27.70	
CH2520U5	US5	30.00	
CH2520U10B	US10B	30.00	CASE QTY 100 PR
CH2520U14	US14	30.00	
CH2520U15	US15	30.00	
CH2520U15A	US15A	30.00	WOOD SCREW #7 x 3/4"
CH2520U26	US26	30.00	
CH2520U26D	US26D	30.00	
CH2520CR003	CR003	35.00	



2 1/2" x 2 1/2"

Part Number	Finish	List Price Pair	THICK 0.093"
CH2525U3-UNL	US3-UNL	28.50	BOX QTY 3 PR
CH2525U3	US3	28.50	
CH2525U5	US5	32.00	
CH2525U10B	US10B	32.00	CASE QTY 100 PR
CH2525U14	US14	32.00	
CH2525U15	US15	32.00	
CH2525U15A	US15A	32.00	WOOD SCREW #7 x 3/4"
CH2525U26	US26	32.00	
CH2525U26D	US26D	32.00	
CH2525CR003	CR003	40.00	



3" x 2"

Part Number	Finish	List Price Pair	THICK 0.125"
CH3020U3-UNL	US3-UNL	28.50	BOX QTY 2 PR
CH3020U3	US3	28.50	
CH3020U5	US5	32.00	
CH3020U10B	US10B	32.00	CASE QTY 70 PR
CH3020U14	US14	32.00	
CH3020U15	US15	32.00	
CH3020U15A	US15A	32.00	WOOD SCREW #7 x 3/4"
CH3020U26	US26	32.00	
CH3020U26D	US26D	32.00	
CH3020CR003	CR003	40.00	



All Solid Brass Cabinet Hinges come standard with ball-tip finials.

Cabinet Hinges / Solid Brass / Full Mortise / Extruded

Cabinet Hinges / Solid Brass / Full Mortise / Extruded

3"x 2 1/2"

Part Number	Finish	List Price Pair	THICK 0.125"
CH3025U3-UNL	US3-UNL	30.00	BOX QTY 2 PR
CH3025U3	US3	30.00	
CH3025U5	US5	35.00	
CH3025U10B	US10B	35.00	CASE QTY 70 PR
CH3025U14	US14	35.00	
CH3025U15	US15	35.00	
CH3025U15A	US15A	35.00	WOOD SCREW #7 x 3/4"
CH3025U26	US26	35.00	
CH3025U26D	US26D	35.00	
CH3025CR003	CR003	42.00	



All Solid Brass Cabinet Hinges come standard with ball-tip finials.

Half Surface Hinge / Solid Brass

Part Number	Finish	List Price Pair	WOOD SCREW #10X1"
DHS3035U3	US3	45.00	THICK 0.135"
DHS3035U5	US5	48.00	
DHS3035U10B	US10B	48.00	
DHS3035U15	US15	48.00	CASE QTY 30 PR
DHS3035U15A	US15A	48.00	
DHS3035U19	US19	48.00	
DHS3035U26	US26	48.00	
DHS3035U26D	US26D	48.00	
DHS3035CR003	CR003	56.00	



A half-surface hinge is used when installing a screen door into an existing frame. Accepts Deltana standard finials.

Cabinet Finials / Solid Brass

Acorn Tip

Part Number	Finish	List Price Each	HEIGHT 1/2"
CHAT3-UNL	US3-UNL	2.40	5/16"
CHAT3	US3	2.40	
CHAT5	US5	2.40	
CHAT10B	US10B	2.40	THREAD 5 x 0.8 mm
CHAT14	US14	2.40	
CHAT15	US15	2.40	
CHAT15A	US15A	2.40	
CHAT26	US26	2.40	
CHAT26D	US26D	2.40	
CHAT003	CR003	3.00	



Urn Tip

Part Number	Finish	List Price Each	HEIGHT 7/8"
CHUT3-UNL	US3-UNL	2.40	5/16"
CHUT3	US3	2.40	
CHUT5	US5	2.40	
CHUT10B	US10B	2.40	THREAD 5 x 0.8 mm
CHUT14	US14	2.40	
CHUT15	US15	2.40	
CHUT15A	US15A	2.40	
CHUT26	US26	2.40	
CHUT26D	US26D	2.40	
CHUT003	CR003	3.00	



Windsor Tip

Part Number	Finish	List Price Each	HEIGHT 5/8"
CHWT3-UNL	US3-UNL	2.40	5/16"
CHWT3	US3	2.40	
CHWT5	US5	2.40	
CHWT10B	US10B	2.40	THREAD 5 x 0.8 mm
CHWT14	US14	2.40	
CHWT15	US15	2.40	
CHWT15A	US15A	2.40	
CHWT26	US26	2.40	
CHWT26D	US26D	2.40	
CHWT003	CR003	3.00	



Button Tip

Part Number	Finish	List Price Each	HEIGHT 1/8"
CHBU3-UNL	US3-UNL	2.40	5/16"
CHBU3	US3	2.40	
CHBU5	US5	2.40	
CHBU10B	US10B	2.40	THREAD 5 x 0.8 mm
CHBU14	US14	2.40	
CHBU15	US15	2.40	
CHBU15A	US15A	2.40	
CHBU26	US26	2.40	
CHBU26D	US26D	2.40	
CHBU003	CR003	3.00	



Steeple Tip

Part Number	Finish	List Price Each	HEIGHT 5/8"
CHST3-UNL	US3-UNL	2.40	5/16"
CHST3	US3	2.40	
CHST5	US5	2.40	
CHST10B	US10B	2.40	THREAD 5 x 0.8 mm
CHST14	US14	2.40	
CHST15	US15	2.40	
CHST15A	US15A	2.40	
CHST26	US26	2.40	
CHST26D	US26D	2.40	
CHST003	CR003	3.00	



Ball Tip

Part Number	Finish	List Price Each	HEIGHT 3/8"
CHBT3-UNL	US3-UNL	2.40	5/16"
CHBT3	US3	2.40	
CHBT5	US5	2.40	
CHBT10B	US10B	2.40	THREAD 4 x 0.5 mm
CHBT14	US14	2.40	
CHBT15	US15	2.40	
CHBT15A	US15A	2.40	
CHBT26	US26	2.40	
CHBT26D	US26D	2.40	
CHBT003	CR003	3.00	



Additional Ball Tips are also available.

Deltana Cabinet Finials come installed with ball tips.

Pivot Hinges / Solid Brass

3 7/8" x 5/8" x 1 5/8"

Part Number	Finish	List Price Pair	MAX LOAD
PH35U3	US3	42.00	35 LB
PH35U5	US5	49.00	WOOD SCREW #10x1"
PH35U10B	US10B	49.00	
PH35U14	US14	49.00	THICK 0.250"
PH35U15	US15	49.00	
PH35U15A	US15A	49.00	BOX QTY 1 PR
PH35U19	US19	49.00	
PH35U26	US26	49.00	CASE QTY 30 PR
PH35U26D	US26D	49.00	
PH35CR003	CR003	52.00	



4 3/8" x 5/8" x 1 7/8"

Part Number	Finish	List Price Pair	MAX LOAD
PH40U3	US3	55.00	70 LB
PH40U5	US5	58.00	WOOD SCREW #10x1"
PH40U10B	US10B	58.00	
PH40U14	US14	58.00	THICK 0.250"
PH40U15	US15	58.00	
PH40U15A	US15A	58.00	BOX QTY 1 PR
PH40U19	US19	58.00	
PH40U26	US26	58.00	CASE QTY 30 PR
PH40U26D	US26D	58.00	
PH40CR003	CR003	64.00	



4 3/8" x 5/8" x 1 7/8"

Part Number	Finish	List Price Pair	MAX LOAD
PH60U3	US3	122.00	200 LB
PH60U5	US5	140.00	WOOD SCREW #12x1 1/4"
PH60U10B	US10B	140.00	
PH60U14	US14	140.00	THICK 0.375"
PH60U15	US15	140.00	
PH60U15A	US15A	140.00	BOX QTY 1 PR
PH60U19	US19	140.00	
PH60U26	US26	140.00	CASE QTY 20 PR
PH60U26D	US26D	140.00	
PH60CR003	CR003	155.00	



Built-in needle bearing for higher weight capacity.

PH60 Installation Instructions

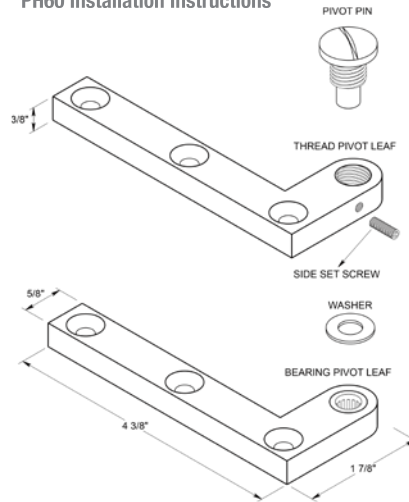

1. Disassemble the pivot as shown by unscrewing the side set screw.
2. Mortise the threaded pivot leaf at the bottom of the door.
3. Mortise the bearing pivot leaf into the floor.
4. Place the washer between the two leaves and thread the pivot pin down.
5. Secure installation by tightening the set screw.

All Pivot Hinges are sold in pairs. One pair contains one Left and one Right pivot hinge.

The PH60 design has universal / reversible handing.

Pivot Base / Solid Brass

Part Number	Finish	List Price Each	BOX QTY
PB985U3	US3	18.00	10 EA
PB985U5	US5	18.00	CASE QTY 300 EA
PB985U10B	US10B	18.00	
PB985U14	US14	18.00	THICK 0.306"
PB985U15	US15	18.00	
PB985U15A	US15A	18.00	BOX QTY 1 PR
PB985U19	US19	18.00	
PB985U26	US26	18.00	CASE QTY 30 PR
PB985U26D	US26D	18.00	
PB985CR003	CR003	21.00	



Pivot Base for use with PH60. Ideal for tile and stone floors.

Intermediate Pivot Hinge / Solid Brass

Part Number	Finish	List Price Pair	WOOD SCREW
SBIH2510U3	US3	108.00	#12x1 1/4"
SBIH2510U5	US5	108.00	THICK 0.306"
SBIH2510U10B	US10B	108.00	
SBIH2510U15	US15	108.00	BOX QTY 1 PR
SBIH2510U15A	US15A	108.00	
SBIH2510U19	US19	108.00	CASE QTY 30 PR
SBIH2510U26	US26	108.00	
SBIH2510U26D	US26D	108.00	
SBIH2510CR003	CR003	115.00	



Parliament Hinges / Solid Brass / Full Mortise / Extruded

3"x 4"

Part Number	Finish	List Price Pair	WOOD SCREW #10x1 1/4"
DSPA3040U3	US3	55.00	THICK 0.157"
DSPA3040U5	US5	55.00	
DSPA3040U10B	US10B	55.00	CASE QTY 30 PR
DSPA3040U15	US15	55.00	
DSPA3040U15A	US15A	55.00	
DSPA3040U26	US26	55.00	
DSPA3040U26D	US26D	55.00	
DSPA3040CR003	CR003	60.00	



4"x 6"

Part Number	Finish	List Price Pair	WOOD SCREW #10x1 1/4"
DSPA4060U3	US3	85.00	THICK 0.157"
DSPA4060U5	US5	85.00	
DSPA4060U10B	US10B	85.00	CASE QTY 20 PR
DSPA4060U15	US15	85.00	
DSPA4060U15A	US15A	85.00	
DSPA4060U26	US26	85.00	
DSPA4060U26D	US26D	85.00	
DSPA4060CR003	CR003	90.00	



4"x 4"

Part Number	Finish	List Price Pair	WOOD SCREW #10x1 1/4"
DSPA4040U3	US3	65.00	THICK 0.157"
DSPA4040U5	US5	65.00	
DSPA4040U10B	US10B	65.00	CASE QTY 30 PR
DSPA4040U15	US15	65.00	
DSPA4040U15A	US15A	65.00	
DSPA4040U26	US26	65.00	
DSPA4040U26D	US26D	65.00	
DSPA4040CR003	CR003	69.00	

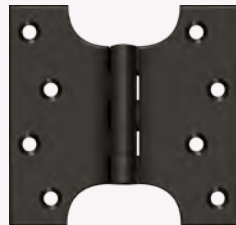

Note:

Interchangeable finial tips are not compatible with our Parliament Hinges.

Parliament hinges are measured Height x Width and are tooled for a tight knuckle action.

Invisible / Concealed Hinges / Solid Brass

2 3/4"x 5/8"

Part Number	Finish	List Price Pair	WOOD SCREW #9x1-1/2"
DCH208U15	US15	40.00	CASE QTY 50 PR
DCH208U26D	US26D	38.00	



4 5/8"x 1 1/8"

Part Number	Finish	List Price Pair	WOOD SCREW #10x1 3/8"
DCH218U4	US4	78.00	CASE QTY 10 PR
DCH218U15	US15	80.00	
DCH218U26D	US26D	78.00	



4 5/8"x 1"

Part Number	Finish	List Price Pair	WOOD SCREW #12x1 3/8"
DCH216U4	US4	68.00	CASE QTY 10 PR
DCH216U15	US15	70.00	
DCH216U26D	US26D	68.00	



Deltana concealed hinges are not visible when the door is in the closed position. Concealed hinges open up to 180 degrees.

Steel, Stainless Steel & Spring Hinges

	Pages
Stainless Steel Hinges.....	3 - 2
Steel Hinges.....	3 - 5
Pins for Steel Residential Hinges.....	3 - 10
Spring Hinges, Single Action, Steel, UL Listed.....	3 - 11
Spring Hinges, Double Action.....	3 - 12
Jamb Bracket for Double Action Spring Hinge.....	3 - 12
Plates for Double Action Spring Hinge.....	3 - 12



 Custom NRP available.

STAINLESS STEEL HINGES



Stainless Steel Hinges / US32D - Brushed Finish

3" x 3" / Residential

Part Number	Corners	List Price/Pair	WOOD SCREW #9x3/4"	CASE QTY 30 PR
SS33U32D-R	Square	17.00		

3" x 3" / Standard

Part Number	Corners	List Price/Pair	WOOD SCREW #9x3/4"	CASE QTY 30 PR
SS33U32D	Square	21.00		

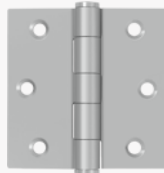

4" x 4" / Square Corners / Residential

Part Number	List Price/Pair	WOOD SCREW #10x1"	CASE QTY 30 PR
SS44U32D-R	32.00		
SS44BU32D-R	34.00		

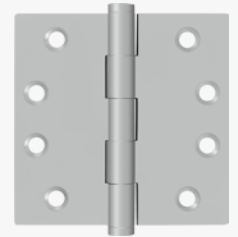

4" x 4" / 5/8" Radius Corners / Residential

Part Number	List Price/Pair	WOOD SCREW #10x1"	CASE QTY 30 PR
SS44R5U32D-R	32.00		
SS44R5U32D-RN	34.00		



3 1/2" x 3 1/2" / Residential

Part Number	Corners	Machine Screw	List Price/Pair	WOOD SCREW #10x1"	CASE QTY 30 PR
SS35U32D-R	Square	#10x1/2"	25.00		
SS35BU32D-R	Square	#10x1/2"	28.00		
SS35R5U32D-R	5/8" Rad	N/A	25.00		

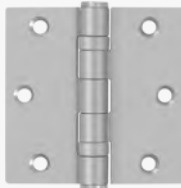

3 1/2" x 3 1/2" / Standard

Part Number	Corners	List Price/Pair	WOOD SCREW #10x1"	MACHINE SCREW #10x1/2"	CASE QTY 30 PR
SS35U32D	Square	30.00			
SS35BU32D	Square	34.00			

4" x 4" / Square Corners / Standard

Part Number	List Price/Pair	WOOD SCREW #12x1/4"	MACHINE SCREW #12x1/2"	CASE QTY 30 PR
SS44U32D	36.00			
SS44BU32D	40.00			
SS44NU32D	40.00			
SS44NBU32D	43.00			

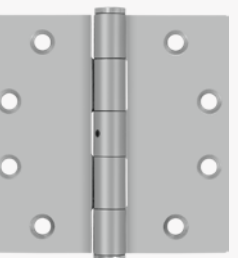

4" x 3" / Ball Bearing / Standard

Part Number	Corners	List Price/Pair	WOOD SCREW #10x1/4"	CASE QTY 30 PR
SS4030BU32D	Square	30.00		

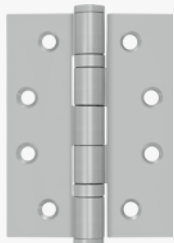

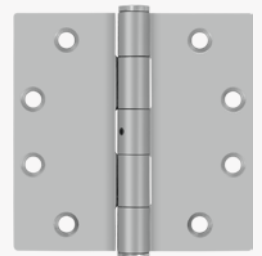

4 1/2" x 4 1/2" / Square Corners / Standard

Part Number	Options	List Price/Pair	WOOD SCREW #12x1/4"	CASE QTY 24 PR	MACHINE SCREW #12x1/2"
SS45U32D	Standard	44.50			
SS45BU32D	BB	47.50			
SS45NU32D	NRP	47.50			
SS45NBU32D	NRP/BB	50.00			



 Ball Bearing

 Ball Bearing
 NRP (Non-Removable Pin)
 Ball Bearing / NRP

Stainless Steel Hinges / Special Features / US32D - Brushed Finish

**4" x 4" / 5/8" Radius x Square Corners
Residential / Security**

Part Number	Options	List Price/ Pair	WOOD SCREW #10x3/4"
SS44058TA32D-LH	Sec	40.00	
SS44058TA32D-RH	Sec	40.00	
			CASE QTY 50 PR

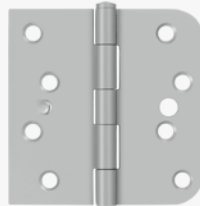

Right - Hand

**4" x 4" x 5/8" Radius x Square Corners
Residential / Ball Bearing / Security**

Part Number	Options	List Price/ Pair	WOOD SCREW #10x3/4"
SS44058B32DLH-S	BB/Sec	44.00	
SS44058B32DRH-S	BB/Sec	44.00	
			CASE QTY 30 PR

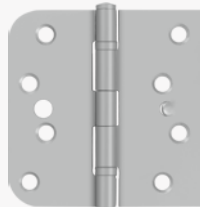

Left - Hand

**4" x 4" x 5/8" Radius Corners
Residential / Ball Bearing / Security**

Part Number	Options	List Price/ Pair	WOOD SCREW #10x3/4"
SS44R5BU32D-S	BB/Sec	44.00	
			CASE QTY 30 PR

4 1/2" x 4 1/2" x 1/4" Radius Corners

Part Number	Options	List Price/ Pair	WOOD SCREW #12x1-1/4"	MACHINE SCREW #12x1/2"	CASE QTY 24 PR
SS45R4SBU32D	BB/Sec	60.50			

4 1/2" x 4 1/2" x 1/4" Radius Corners

Part Number	Options	List Price/ Pair	WOOD SCREW #12x1-1/4"	MACHINE SCREW #12x1/2"	CASE QTY 24 PR
SS4540R4BNUSPW	NRP/BB	60.50			

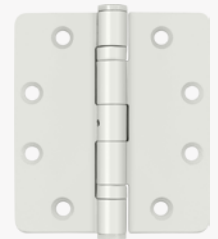
**5" x 5" Square Corners
Heavy Duty / Ball Bearing / Security**

Part Number	Options	List Price/ Pair	WOOD SCREW #10x1-1/4"	MACHINE SCREW #10x1/2"	CASE QTY 24 PR
SS55BBU10B-SEC	BB/Sec	88.00			
SS55BBU15-SEC	BB/Sec	88.00			
SS55BBU32D-SEC	BB/Sec	74.00			



Stainless Steel Hinges / US32 - Polished Finish

3" x 3" / Square Corners / Standard

Part Number	Options	List Price/ Pair	WOOD SCREW #9x3/4"
SS33U32	Standard	23.50	
			CASE QTY 30 PR

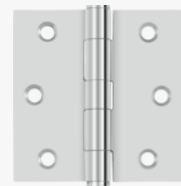
3 1/2" x 3 1/2" / Square Corners / Standard

Part Number	Options	List Price/ Pair	WOOD SCREW #10x1"
SS35U32	Standard	32.00	
SS35BU32	BB	41.50	
			CASE QTY 30 PR
			MACHINE SCREW #10x1/2"

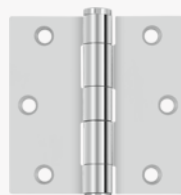
4" x 4" / Square Corners / Standard

Part Number	Options	List Price/ Pair	WOOD SCREW #12x1 1/4"
SS44U32	Standard	39.50	
SS44BU32	BB	42.00	
SS44NBU32	NRP/BB	49.50	
			CASE QTY 24 PR
			MACHINE SCREW #10x1/2"

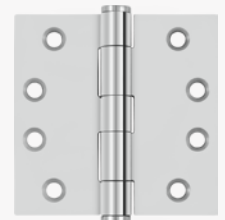

4 1/2" x 4 1/2" / Square Corners / Standard

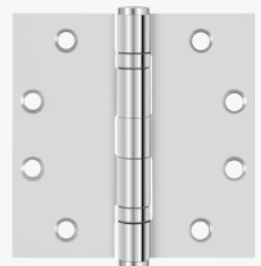
Part Number	Options	List Price/ Pair	WOOD SCREW #12x1/4"
SS45BU32	BB	54.00	
SS45NBU32	NRP/BB	60.00	
			CASE QTY 24 PR
			MACHINE SCREW #10x1/2"

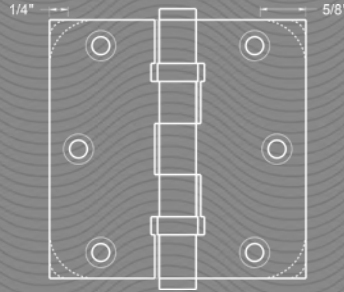

How to Determine the Radius of a Hinge

To determine if you have 1/4" or 5/8" radius corner hinge, measure the beginning of the curve to where the corner of the hinge would be if it were square.

Location of Hinge on the Door

Upper hinge 5" from top jamb to top edge of barrel.
 Bottom hinge 10" from bottom edge of barrel to finished floor.
 Middle centered between top and bottom hinges.



Check out Deltana's corner chisel tool. See 12 - 4.

How to Select the Proper Hinge Size

To choose the proper hinge size consider the following:

Thickness of Door	Width of Door	Height of Hinge
1-3/8" Door	To 32"	3-1/2"
1-3/8" Door	32" to 36"	4"
1-3/4" Door	To 36"	4-1/2"
1-3/4" Door	36" to 48"	5"
1-3/4" Door	Over 48"	6"
2", 2-1/4", 2-1/2" Door	To 42"	5" Commercial
2", 2-1/4", 2-1/2" Door	Over 42"	6" Commercial

Number of Hinges per Door

As a general rule, you will want to use 1 hinge per every 30" of door or fraction thereof. Referring to door height:

Doors up to 60" need 2 hinges, doors over 60" but not over 90" need 3 hinges and doors over 90" but not over 120" need 4 hinges.

NRP

A hinge equipped with a non-removable pin cannot be disassembled without first opening the hinge to reveal the set-screw embedded perpendicularly on its inside face.

These are commonly found on outswing exterior doors that require their pin barrels to be exposed on the outside of the installation.

If not available, the NRP feature can be added upon request.

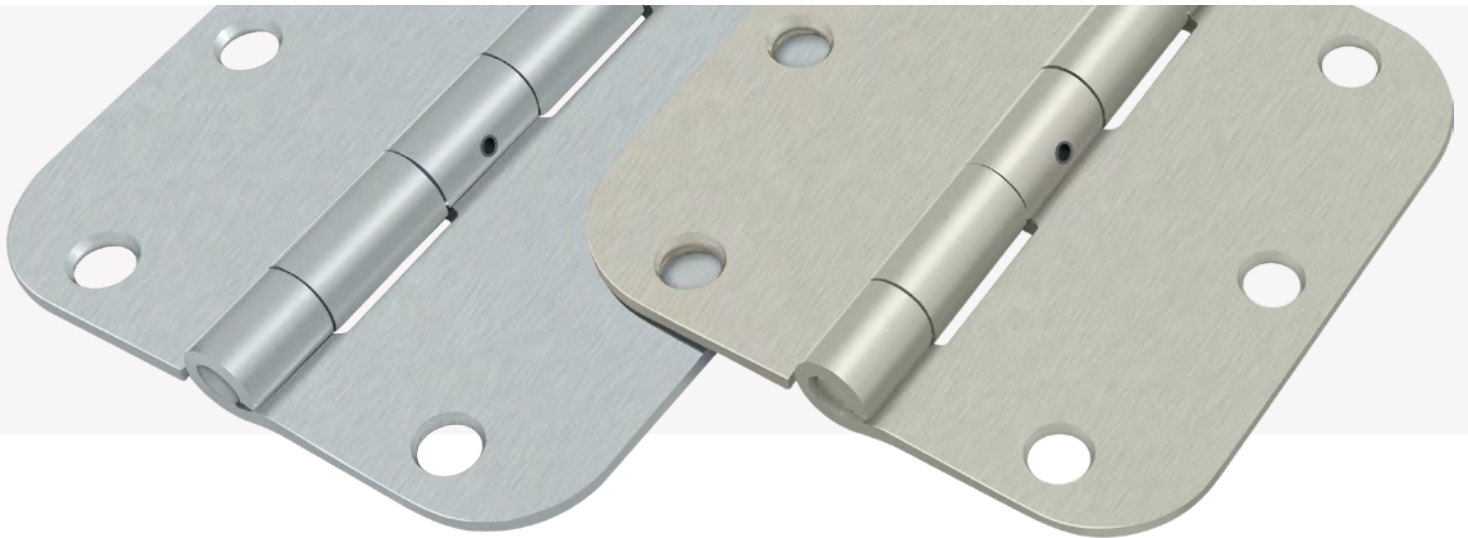

Steel Hinges

3" x 3" / Square Corner / Residential

Part Number	Finish	List Price Pair	WOOD SCREW #9x3/4"
S33U3-R	US3	6.50	THICK 0.085"
S33U4-R	US4	6.00	
S33U5-R	US5	8.00	
S33U10B-R	US10B	8.00	
S33U15-R	US15	8.00	
S33U26D-R	US26D	6.50	CASE QTY 50 PR

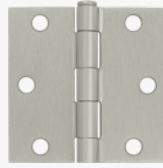

3" x 3" x 1/4" Radius Corner / Residential

Part Number	Finish	List Price Pair	WOOD SCREW #9x3/4"
S33R42D	US2D	6.00	THICK 0.085"
S33R4USPW	White	6.00	
			CASE QTY 50 PR



3 1/2" x 3 1/2" / Square Corner / Residential

Part Number	Finish	List Price Pair	WOOD SCREW #9x3/4"
S35U1B-R	US1B	9.80	THICK 0.085"
S35U3-R	US3	9.80	
S35U4-R	US4	8.00	
S35U5-R	US5	9.80	
S35U10B-R	US10B	9.80	
S35U14-R	US14	9.80	CASE QTY 50 PR
S35U15-R	US15	9.80	
S35U15A-R	US15A	9.80	
S35U26-R	US26	10.40	
S35U26D-R	US26D	9.80	

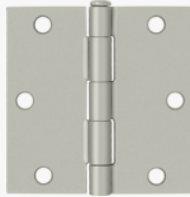

3 1/2" x 3 1/2" / Square Corner / Heavy Duty

Part Number	Finish	List Price Pair	WOOD SCREW #10x1"
S35HD1B	US1B	15.70	THICK 0.119"
S35HD3	US3	15.70	
S35HD5	US5	15.70	
S35HD10B	US10B	15.70	
S35HD15	US15	15.70	
S35HD15A	US15A	15.70	CASE QTY 50 PR
S35HD26	US26	16.20	
S35HD26D	US26D	15.70	
S35HDUSPW	White	11.10	



3 1/2" x 3 1/2" x 1/4" Radius Corner / Heavy Duty

Part Number	Finish	List Price Pair	WOOD SCREW #10x1"
S35R4HD3	US3	15.70	THICK 0.119"
S35R4HD5	US5	15.70	
S35R4HD10B	US10B	15.70	
S35R4HD15	US15	15.70	
S35R4HD15A	US15A	15.70	
S35R4HD26	US26	16.20	CASE QTY 50 PR
S35R4HD26D	US26D	15.70	



3 1/2" x 3 1/2" x 1/4" Radius Corner / Residential

Bulk Pack / Sold in Case Quantities Only			WOOD SCREW #9x3/4"
Part Number	Finish	List Price Pair	
S35R4BK1B	US1B	9.40	THICK 0.085"
S35R4BK2D-UN	US2D	7.00	
S35R4BK2D	US2D	7.00	
S35R4BK3	US3	9.40	
S35R4BK3/4	US3/4	7.00	
S35R4BK4	US4	7.00	CASE QTY 50 PR
S35R4BK5	US5	9.40	
S35R4BK10B	US10B	9.40	
S35R4BK15	US15	9.40	
S35R4BK15A	US15A	9.40	
S35R4BK26	US26	10.00	
S35R4BK26D	US26D	9.40	



3 1/2" x 3 1/2" x 1/4" Radius Corner / NRP

Part Number	Finish	List Price Pair	WOOD SCREW #10x1"
S35R4N3	US3	7.50	THICK 0.119"
S35R4N5	US5	9.50	
S35R4N10B	US10B	10.50	
S35R4N15	US15	10.50	
S35R4N15A	US15A	10.50	
S35R4N26	US26	9.50	CASE QTY 50 PR
S35R4N26D	US26D	7.50	
S35R4N1B	US1B	9.50	



Unassembled

3 1/2" x 3 1/2" x 1/4" Residential / Radius Corner / Ball Bearing

Part Number	Finish	List Price Pair	WOOD SCREW #9x3/4"
S35R4BB3	US3	11.00	THICK 0.085"
S35R4BB4	US4	9.00	
S35R4BB5	US5	11.00	
S35R4BB10B	US10B	11.00	
S35R4BB15	US15	11.00	
S35R4BB15A	US15A	11.00	CASE QTY 50 PR
S35R4BB26	US26	11.80	
S35R4BB26D	US26D	11.00	
S35R4BB26D	US26D	11.00	



3 1/2" x 3 1/2" x 1/4" Radius Corner Residential / Ball Tips

Part Number	Finish	List Price Pair	WOOD SCREW #9x3/4"
S35R43-BT	US3	13.20	THICK 0.085"
S35R45-BT	US5	13.20	
S35R410B-BT	US10B	13.20	
S35R415-BT	US15	13.20	
S35R415A-BT	US15A	13.20	
S35R426-BT	US26	14.00	CASE QTY 30 PR
S35R426D-BT	US26D	13.20	

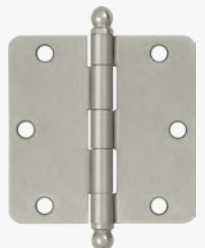

Steel Hinges

3 1/2" x 3 1/2" x 1/4" Radius Corner / Residential

Part Number	Finish	List Price Pair	WOOD SCREW #9x3/4"
S35R41B	US1B	9.80	
S35R43	US3	9.80	
S35R44	US4	8.00	THICK 0.085"
S35R45	US5	9.80	
S35R410B	US10B	9.80	
S35R414	US14	10.40	CASE QTY 50 PR
S35R415	US15	9.80	
S35R415A	US15A	9.80	
S35R426	US26	10.40	
S35R426D	US26D	9.80	

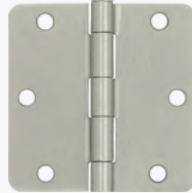
3 1/2" x 3 1/2" x 5/8" Radius Corner / Residential

Part Number	Finish	List Price Pair	WOOD SCREW #9x3/4"
S35R51B	US1B	9.80	
S35R53	US3	9.80	
S35R54	US4	8.00	THICK 0.085"
S35R55	US5	9.80	
S35R510B	US10B	9.80	
S35R514	US14	10.40	CASE QTY 50 PR
S35R515	US15	9.80	
S35R515A	US15A	9.80	
S35R526	US26	10.40	
S35R526D	US26D	9.80	

3 1/2" x 3 1/2" x 5/8" Radius Corner / Residential

Bulk Pack / Sold in Case Quantities Only			WOOD SCREW #9x3/4"
Part Number	Finish	List Price Pair	
S35R5BK1B	US1B	9.40	THICK 0.085"
S35R5BK2D-UN	US2D	7.00	
S35R5BK2D	US2D	7.00	
S35R5BK2G	US2G	5.00	CASE QTY 50 PR
S35R5BK3	US3	9.40	
S35R5BK3/4	US3/4	7.00	
S35R5BK4	US4	7.00	
S35R5BK5	US5	9.40	
S35R5BK10B	US10B	9.40	
S35R5BK15	US15	9.40	
S35R5BK15A	US15A	9.40	
S35R5BK26	US26	10.00	
S35R5BK26D	US26D	9.40	
S35R5BKUSPW	White	7.00	

3 1/2" x 3 1/2" x 5/8" Radius Corner Residential / NRP

Part Number	Finish	List Price Pair	WOOD SCREW #9x3/4"
S35R5N1B	US1B	13.00	
S35R5N3	US3	13.00	
S35R5N5	US5	13.00	THICK 0.085"
S35R5N10B	US10B	13.00	
S35R5N15	US15	13.00	CASE QTY 50 PR
S35R5N15A	US15A	13.00	
S35R5N26	US26	13.00	
S35R5N26D	US26D	13.00	



Non-Removable Pin

Unassembled

3 1/2" x 3 1/2" x 5/8" Radius Corner / Heavy Duty

Part Number	Finish	List Price Pair	WOOD SCREW #10x1"
S35R5HD1B	US1B	15.70	
S35R5HD3	US3	15.70	
S35R5HD5	US5	15.70	THICK 0.119"
S35R5HD10B	US10B	15.70	
S35R5HD15	US15	15.70	CASE QTY 50 PR
S35R5HD15A	US15A	15.70	
S35R5HD26	US26	16.20	
S35R5HD26D	US26D	15.70	

3 1/2" x 3 1/2" x 5/8" Radius Corner Residential / Ball Tip

Part Number	Finish	List Price Pair	WOOD SCREW #9x3/4"
S35R53-BT	US3	13.20	
S35R55-BT	US5	13.20	
S35R510B-BT	US10B	13.20	THICK 0.085"
S35R515-BT	US15	13.20	
S35R515A-BT	US15A	13.20	CASE QTY 50 PR
S35R526-BT	US26	14.00	
S35R526D-BT	US26D	13.20	

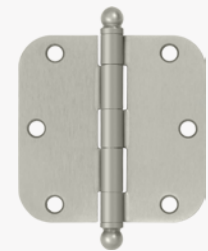
3 1/2" x 3 1/2" x 5/8" Radius Corner Residential / Ball Bearing

Part Number	Finish	List Price Pair	WOOD SCREW #9x3/4"
S35R5BB3	US3	11.00	
S35R5BB4	US4	9.00	
S35R5BB5	US5	11.00	THICK 0.085"
S35R5BB10B	US10B	11.00	
S35R5BB15	US15	11.00	CASE QTY 50 PR
S35R5BB15A	US15A	11.00	
S35R5BB26	US26	11.80	
S35R5BB26D	US26D	11.00	

4" x 4" / Square Corners / Residential

Part Number	Finish	List Price Pair	WOOD SCREW #9x1"
S44U1B-R	US1B	11.10	
S44U3-R	US3	11.10	
S44U4-R	US4	9.80	MACHINE SCREW #9x1"
S44U5-R	US5	11.10	
S44U10B-R	US10B	11.10	
S44U14-R	US14	12.50	THICK 0.085"
S44U15-R	US15	11.10	
S44U15A-R	US15A	11.10	CASE QTY 50 PR
S44U26-R	US26	12.50	
S44U26D-R	US26D	11.10	



Steel Hinges

4"x 4" / Square Corners / Heavy Duty

Part Number	Finish	List Price Pair	WOOD SCREW #12x1"
S44HD1B	US1B	16.75	MACHINE SCREW #12x1/2"
S44HD3	US3	16.75	
S44HD5	US5	16.75	THICK 0.129"
S44HD10B	US10B	16.75	
S44HD15	US15	16.75	CASE QTY 30 PR
S44HD15A	US15A	16.75	
S44HD26	US26	17.20	
S44HD26D	US26D	16.75	
S44HDUSPW	White	12.30	

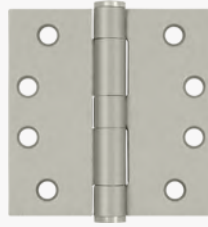

4"x 4" / Heavy Duty / Ball Bearing / Square Corners

Part Number	Finish	List Price Pair	WOOD SCREW #12x1"
S44HDBB1B	US1B	24.40	MACHINE SCREW #12x1/2"
S44HDBB3	US3	24.40	
S44HDBB4	US4	24.40	THICK 0.129"
S44HDBB5	US5	24.40	
S44HDBB10B	US10B	24.40	CASE QTY 30 PR
S44HDBB15	US15	24.40	
S44HDBB15A	US15A	24.40	
S44HDBB26	US26	24.40	
S44HDBB26D	US26D	24.40	
S44HDBBUSPW	White	23.50	

 4"x 4" / Square Corners
Special Features / Residential

Part Number	Finish	Wood Screw	List Price Pair
S44USPW-RS	White	#10x1"	10.00
S444BMS(Bulk)	US4	#9x3/4"	10.00

THICK 0.085" CASE QTY 50 PR



4"x 4" / Square Corners / NRP

Part Number	Finish	Wood Screw	List Price Pair
S44NRP/USP	USP	#12x1/4"	16.00
S44NRP/US3	US3	#12x1/4"	16.00

CASE QTY 50 PR THICK 0.129"



4"x 4"x 5/8" Radius Corners / Residential

Part Number	Finish	List Price Pair	WOOD SCREW #9x1"
S44R51B	US1B	11.10	THICK 0.085"
S44R53	US3	11.10	
S44R54BM	US4	9.80	CASE QTY 50 PR
S44R54BMS	US4	9.80	
S44R55	US5	11.10	
S44R510B	US10B	11.10	
S44R514	US14	12.50	
S44R515	US15	11.10	
S44R515A	US15A	11.10	
S44R526	US26	12.50	
S44R526D	US26D	11.10	
S44R5USPW	White	9.80	
S44R5USPW BMS	White	9.80	

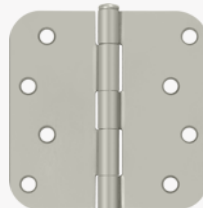

4"x 4"x 5/8" Radius Corners / Heavy Duty / BB

Part Number	Finish	List Price Pair	WOOD SCREW #12x1"
S44R5HDB1B	US1B	24.40	MACHINE SCREW #12x1/2"
S44R5HDB3	US3	24.40	
S44R5HDB4	US4	24.40	THICK 0.129"
S44R5HDB5	US5	24.40	
S44R5HDB10B	US10B	24.40	CASE QTY 30 PR
S44R5HDB15	US15	24.40	
S44R5HDB15A	US15A	24.40	
S44R5HDB26	US26	24.40	
S44R5HDB26D	US26D	24.40	

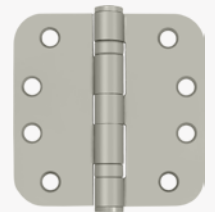

4"x 4"x 5/8" Radius Corner / NRP / Residential

Part Number	Finish	List Price Pair	WOOD SCREW #9x1"
S44R5N1B	US1B	16.00	THICK 0.085"
S44R5N3	US3	16.00	
S44R5N5	US5	16.00	CASE QTY 50 PR
S44R5N10B	US10B	16.00	
S44R5N15	US15	16.00	
S44R5N15A	US15A	16.00	
S44R5N26	US26	16.00	
S44R5N26D	US26D	16.00	



4"x 4"x 5/8" Radius Corners / BB / Residential

Part Number	Finish	List Price Pair	WOOD SCREW #9x1"
S44R5BB3	US3	13.50	THICK 0.085"
S44R5BB4	US4	13.50	
S44R5BB5	US5	13.50	CASE QTY 50 PR
S44R5BB10B	US10B	13.50	
S44R5BB15	US15	13.50	
S44R5BB15A	US15A	13.50	
S44R5BB26	US26	13.50	
S44R5BB26D	US26D	13.50	



- Benchmark
- Benchmark, Security Tab

Steel Hinges

4" x 4" x 5/8" Radius Corners / Residential

Bulk Pack / Sold in Case Quantities Only			WOOD SCREW #9X3/4"
Part Number	Finish	List Price Pair	
S44R5BK2D	US2D	8.50	THICK 0.085"
S44R5BK2D-S	US2D	9.00	
S44R5BK2D-UN	US2D	8.50	CASE QTY 50 PR
S44R5BK2G	US2G	8.50	
S44R5BK3	US3	12.00	
S44R5BK3/4	US3/4	8.50	
S44R5BK4	US4	8.50	
S44R5BK4S	US4	9.00	
S44R5BK5	US5	12.00	
S44R5BK5S	US5	13.00	
S44R5BK10B	US10B	12.00	
S44R5BK15	US15	12.00	
S44R5BK15-S	US15	13.00	
S44R5BK15A	US15A	12.00	
S44R5BK26	US26	12.00	
S44R5BK26D	US26D	12.00	
S44R5BKUSPW	White	8.50	
S44R5BKUSPW-S	White	9.00	



4" x 4" x 5/8" Radius Corner Residential / Security Stud

Part Number	Finish	List Price Pair	WOOD SCREW #9x1"
S44R53-SEC	US3	16.00	
S44R55-SEC	US5	16.00	THICK 0.085"
S44R510B-SEC	US10B	16.00	
S44R515-SEC	US15	16.00	CASE QTY 50 PR
S44R526-SEC	US26	16.00	
S44R526D-SEC	US26D	16.00	

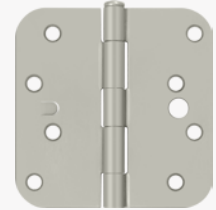

4" x 4" x 5/8" Radius Corners Residential / Ball Tips

Part Number	Finish	List Price Pair	WOOD SCREW #10x1"
S44R53-BT	US3	16.00	
S44R55-BT	US5	16.00	THICK 0.085"
S44R510B-BT	US10B	16.00	
S44R515-BT	US15	16.00	CASE QTY 50 PR
S44R515A-BT	US15A	16.00	
S44R526-BT	US26	16.00	
S44R526D-BT	US26D	16.00	

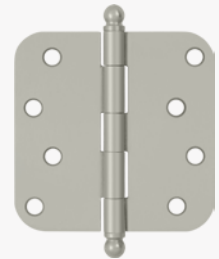

4" x 4" x 1/4" Radius Corner / Residential

Bulk Pack / Sold in Case Quantities Only			WOOD SCREW #9X3/4"
Part Number	Finish	List Price Pair	
S44R4BK2D	US2D	8.50	THICK 0.085"
S44R4BK2D-UN	US2D	8.50	
S44R4BK3	US3	12.00	CASE QTY 50 PR
S44R4BK3/4	US3/4	8.50	
S44R4BK3/4-UN	US3/4	8.50	
S44R4BK4	US4	8.50	
S44R4BK4S	US4	9.00	
S44R4BK10B	US10B	12.00	
S44R4BK15	US15	12.00	
S44R4BK15A	US15A	12.00	
S44R4BK26	US26	12.00	
S44R4BK26D	US26D	12.00	



4" x 4" x 1/4" Radius Corner / NRP / Residential

Part Number	Finish	List Price Pair	WOOD SCREW #9x1"
S44R4N1B	US1B	16.00	
S44R4N3	US3	16.00	THICK 0.085"
S44R4N5	US5	16.00	
S44R4N10B	US10B	16.00	CASE QTY 50 PR
S44R4N15	US15	16.00	
S44R4N15A	US15A	16.00	
S44R4N26	US26	16.00	
S44R4N26D	US26D	16.00	

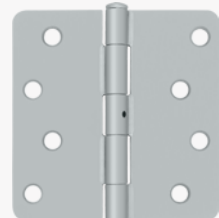

4" x 4" x 1/4" Radius Corner Residential / Box Pack

Part Number	Finish	List Price Pair	WOOD SCREW #9x1"
S44R41B	US1B	11.10	
S44R43	US3	11.10	THICK 0.085"
S44R44	US4	9.80	
S44R44S	US4	11.10	
S44R45	US5	11.10	CASE QTY 50 PR
S44R45SEC5	US5	13.00	
S44R410B	US10B	11.10	
S44R414	US14	12.50	
S44R415	US15	11.10	
S44R415A	US15A	11.10	
S44R426	US26	12.50	
S44R426D	US26D	11.10	



4" x 4" x 1/4" Radius Corner Residential / Ball Bearing

Part Number	Finish	List Price Pair	WOOD SCREW #9x1"
S44R4BB3	US3	13.50	
S44R4BB4	US4	13.50	THICK 0.085"
S44R4BB5	US5	13.50	
S44R4BB10B	US10B	13.50	CASE QTY 50 PR
S44R4BB15	US15	13.50	
S44R4BB15A	US15A	13.50	
S44R4BB26	US26	13.50	
S44R4BB26D	US26D	13.50	

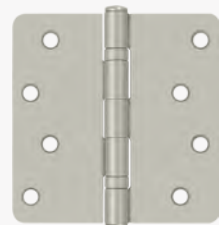

- Unassembled
- Security Tab

Steel Hinges

4" x 4" x 1/4" Radius Corner / Heavy Duty / NRP

Part Number	Finish	List Price Pair	WOOD SCREW #12x1"
S44R4HDN3	US3	24.40	
S44R4HDN5	US5	24.40	
S44R4HDN10B	US10B	24.40	
S44R4HDN15	US15	24.40	
S44R4HDN15A	US15A	24.40	
S44R4HDN26	US26	24.40	
S44R4HDN26D	US26D	24.40	

Non-Removable Pin

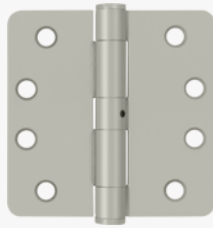

4" x 4" x 1/4" Radius Corner / Heavy Duty

Part Number	Finish	List Price Pair	WOOD SCREW #12x1"
S44R4HD1B	US1B	18.00	
S44R4HD3	US3	18.00	
S44R4HD5	US5	18.00	
S44R4HD10B	US10B	18.00	
S44R4HD15	US15	18.00	
S44R4HD15A	US15A	18.00	
S44R4HD26	US26	19.50	
S44R4HD26D	US26D	18.00	

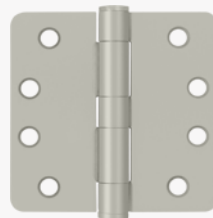

HD / Box Pack 4" x 4" x 1/4" Radius Corner / BB

Part Number	Finish	List Price Pair	WOOD SCREW #12x1"
S44R4HDB3	US3	24.40	
S44R4HDB5	US5	24.40	
S44R4HDB10B	US10B	24.40	
S44R4HDB15	US15	24.40	
S44R4HDB15A	US15A	24.40	
S44R4HDB26	US26	24.40	
S44R4HDB26D	US26D	24.40	



4" x 4" x 1/4" Radius x Square Corners

Part Number	Option	Finish	List Price Pair
EN4404USPW-UN	Sec+Loc. Tab	White	9.00
DE4404TTUSP	Sec+Loc. Tab	White	9.00



4" x 4" x 1/4" Radius Corner Residential / Ball Tip

Part Number	Finish	List Price Pair	WOOD SCREW #10x1"
S44R43-BT	US3	16.00	
S44R45-BT	US5	16.00	
S44R410B-BT	US10B	16.00	
S44R415-BT	US15	16.00	
S44R415A-BT	US15A	16.00	
S44R426-BT	US26	16.00	
S44R426D-BT	US26D	16.00	



4" x 4" x 5/8" Radius x Square Corners / Steel Residential / Security Stud / 2 Aligners / TT

Bulk Pack / Sold in Case Quantities Only			SEC+LOC TAB
Part Number	Finish	List Price Pair	
DE44058TT2D	US2D	9.00	THICK 0.085"
DE44058TA2D-LH	US2D	9.00	
DE44058TA2D-RH	US2D	9.00	
DE44058TT3	US3	12.00	CASE QTY 50 PR
DE44058TT3/4-LH	US3/4	9.00	
DE44058TT3/4-RH	US3/4	9.00	
DE44058TT4	US4	9.00	WOOD SCREW #9X1"
DE44058TT5	US5	12.00	
DE44058TT10B	US10B	12.00	
DE44058TT15	US15	12.00	
DE44058TT15A	US15A	12.00	
DE44058TT26	US26	12.00	
DE44058TT26D	US26D	12.00	
DE44058TTUSPW	White	9.00	
DE44058TAUSPWLH	White	8.00	
DE44058TAUSPWRH	White	8.00	



4" x 4" / 5/8" Radius x Square Corners / Steel Residential / Security Stud

Bulk Pack / Sold in Case Quantities Only			SECURITY TAB
Part Number	Finish	List Price Pair	
S44058TTUSPW-LH	White	9.00	
S44058TTUSPW-RH	White	9.00	
S44058TT2D-LH	US2D	9.00	THICK 0.085"
S44058TT2D-RH	US2D	9.00	
S44058TT3/4-LH	US3/4	9.00	CASE QTY 50 PR
S44058TT3/4-RH	US3/4	9.00	
S44058TT4-UN	US4	9.00	
S44058TT10B-LH	US10B	12.00	
S44058TT10B-RH	US10B	12.00	
S44058TT15-LH	US15	12.00	
S44058TT15-RH	US15	12.00	
S44058TT15A-LH	US15A	12.00	
S44058TT15A-RH	US15A	12.00	
S44058TT26-LH	US26	12.00	
S44058TT26-RH	US26	12.00	
S44058TT26D-LH	US26D	12.00	
S44058TT26D-RH	US26D	12.00	



S44058U3/4-RH	US3/4	8.00	NO SECURITY TAB
---------------	-------	------	-----------------

Unassembled

Steel Hinges

Special Hinge for Fiber Glass Doors
4"x 4 1/4"x 5/8" Radius x Square Corners

Part Number	Finish	List Price Pair	SECURITY TAB
S41/4058USPWL-S	White	9.00	THICK 0.092"
S41/4058USPWR-S	White	9.00	
S41/4058U2DL-S	US2D	9.00	CASE QTY 50 PR
S41/4058U2DR-S	US2D	9.00	
S41/4058U15L-S	US15	12.00	
S41/4058U15R-S	US15	12.00	



S41/4058U15R-S

Heavy Duty / Ball Bearing
4 1/2"x 4 1/2" / Square Corners / Steel

Part Number	Finish	List Price Pair	WOOD SCREW #12x1 1/4"
S45BBU3	US3	25.80	MACHINE SCREW #12x1/2"
S45BBU5	US5	25.80	
S45BBU10B	US10B	25.80	THICK 0.134"
S45BBU15	US15	25.80	
S45BBU15A	US15A	25.80	CASE QTY 30 PR
S45BBU26	US26	25.80	
S45BBU26D	US26D	25.80	
S45BBUSPW	White	21.00	

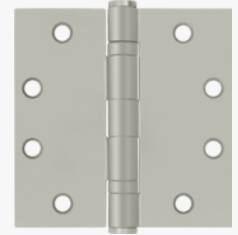
Special Hinge for Fiber Glass Doors / BB
4"x 4 1/4"x 5/8" Radius x Square Corners

Part Number	Finish	List Price Pair	SECURITY TAB
S41/4058BUSPR-S	White	10.00	THICK 0.092"
S41/4058BUSPL-S	White	10.00	
S41/4058BU2DR-S	US2D	10.00	CASE QTY 50 PR
S41/4058BU2DL-S	US2D	10.00	
S41/4058BU15R-S	US15	13.00	
S41/4058BU15L-S	US15	13.00	



S41/4058BU15R-L

Heavy Duty / Ball Bearing / NRP
4 1/2"x 4 1/2" / Square Corners / Steel

Part Number	Finish	List Price Pair	WOOD SCREW #12x1 1/4"
S45BBNU3	US3	28.00	MACHINE SCREW #12x1/2"
S45BBNU5	US5	28.00	
S45BBNU10B	US10B	28.00	THICK 0.134"
S45BBNU15	US15	28.00	
S45BBNU15A	US15A	28.00	CASE QTY 30 PR
S45BBNU26	US26	28.00	
S45BBNU26D	US26D	28.00	
S45BBNUSPW	White	24.00	



Non-Removable Pin

4 1/2"x 4 1/2" / Heavy Duty / Square Corners

Part Number	Finish	List Price Pair	WOOD SCREW #12x1 1/4"
S45U3	US3	21.00	MACHINE SCREW #12x1/2"
S45U5	US5	21.00	
S45U10B	US10B	21.00	THICK 0.134"
S45U15	US15	21.00	
S45U15A	US15A	21.00	CASE QTY 30 PR
S45U26	US26	21.00	
S45U26D	US26D	21.00	
S45USPW	White	18.00	

HD / 5"x 5" / Square Corners / BB

Part Number	Finish	List Price Pair	THICK 0.145"
S55BBUSPW	White	35.00	CASE QTY 24 PR



Pins For Residential Steel Hinges

Pin for 3 1/2"x 3 1/2"

Part Number	Finish	List Price /Each
PIN-ST35U1B	US1B	2.20
PIN-ST35U3	US3	2.20
PIN-ST35U4	US4	2.20
PIN-ST35U5	US5	2.20
PIN-ST35U10B	US10B	2.20
PIN-ST35U15	US15	2.20
PIN-ST35U15A	US15A	2.20
PIN-ST35U26	US26	2.20
PIN-ST35U26D	US26D	2.20

Pin for 4"x 4"

Part Number	Finish	List Price /Each
PIN-ST4U1B	US1B	2.75
PIN-ST4U3	US3	2.75
PIN-ST4U4	US4	2.75
PIN-ST4U5	US5	2.75
PIN-ST4U10B	US10B	2.75
PIN-ST4U15	US15	2.75
PIN-ST4U15A	US15A	2.75
PIN-ST4U26	US26	2.75
PIN-ST4U26D	US26D	2.75



Spring Hinges / Single Action / Steel

3 1/2" x 3 1/2" / Square Corner

Part Number	Finish	List Price Each	WOOD SCREW #9x3/4"
DSH35U1B	US1B	15.00	
DSH35U3	US3	15.00	
DSH35U4	US4	12.50	
DSH35U5	US5	15.00	
DSH35U10B	US10B	15.00	
DSH35U14	US14	15.00	
DSH35U15	US15	15.00	
DSH35U15A	US15A	15.00	
DSH35U26	US26	15.00	
DSH35U26D	US26D	15.00	
DSH35U32D	US32D	20.00	

3 1/2" x 3 1/2" x 1/4" Radius Corner

Part Number	Finish	List Price Each	WOOD SCREW #9x3/4"
DSH35R43	US3	15.00	
DSH35R43/4	US3/4	12.50	
DSH35R44	US4	12.50	
DSH35R45	US5	15.00	
DSH35R410B	US10B	15.00	
DSH35R414	US14	15.00	
DSH35R415	US15	15.00	
DSH35R415A	US15A	15.00	
DSH35R426	US26	15.00	
DSH35R426D	US26D	15.00	

3 1/2" x 3 1/2" x 5/8" Radius Corner

Part Number	Finish	List Price Each	WOOD SCREW #9x3/4"
DSH35R53	US3	15.00	
DSH35R53/4	US3/4	15.00	
DSH35R54	US4	12.50	
DSH35R55	US5	15.00	
DSH35R510B	US10B	15.00	
DSH35R514	US14	15.00	
DSH35R515	US15	15.00	
DSH35R515A	US15A	15.00	
DSH35R526	US26	15.00	
DSH35R526D	US26D	15.00	

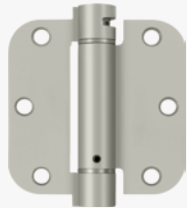
4" x 4" / Square Corner

Part Number	Finish	List Price Each	WOOD SCREW #10x1"
DSH44U1B	US1B	16.80	
DSH44U3	US3	16.80	
DSH44U4	US4	14.50	
DSH44U5	US5	16.80	
DSH44U10B	US10B	16.80	
DSH44U15	US15	16.80	
DSH44U15A	US15A	16.80	
DSH44U26	US26	16.80	
DSH44U26D	US26D	16.80	
DSH44U32D	US32D	24.00	

4" x 4" x 1/4" Radius Corner

Part Number	Finish	List Price Each	WOOD SCREW #10x1"
DSH4R41B	US1B	16.80	
DSH4R42D	US2D	14.50	
DSH4R43	US3	16.80	
DSH4R44	US4	14.50	
DSH4R43/4	US3/4	14.50	
DSH4R45	US5	16.80	
DSH4R410B	US10B	16.80	
DSH4R415	US15	16.80	
DSH4R415A	US15A	16.80	
DSH4R426	US26	16.80	
DSH4R426D	US26D	16.80	

4" x 4" x 5/8" Radius Corner / TT

Part Number	Finish	List Price Each	WOOD SCREW #10x1"
DSH4R52DT	US2D	14.50	
DSH4R53T	US3	16.80	
DSH4R54T	US4	14.50	
DSH4R55T	US5	16.80	
DSH4R510BT	US10B	16.80	
DSH4R515T	US15	16.80	
DSH4R515AT	US15A	16.80	
DSH4R526T	US26	16.80	
DSH4R526DT	US26D	16.80	

4" x 4" x 5/8" Radius x Square TT

Part Number	Finish	List Price Each	WOOD SCREW #10x1"
DSH4R5TT2D	US2D	14.50	
DSH4R5TT4	US4	14.50	
DSH4SR52DBM	US2D	14.50	
DSH4SR515-LH	US15	16.00	
DSH4SR515-RH	US15	16.00	
DSH4SR5USPW-LH	White	14.50	
DSH4SR5USPW-RH	White	14.50	

4" x 4" x 5/8" Radius Corner

Part Number	Finish	List Price Each	WOOD SCREW #10x1"
DSH4R51B	US1B	16.80	
DSH4R52D	US2D	14.50	
DSH4R52DBM	US2D	14.50	
DSH4R53/4	US3/4	14.50	
DSH4R53	US3	16.80	
DSH4R54-Z	US4	14.50	
DSH4R54BM	US4	14.50	
DSH4R55	US5	16.80	
DSH4R5USPW	White	14.50	
DSH4R5USPWBM	White	14.50	
DSH4R510B	US10B	16.80	
DSH4R515	US15	16.80	
DSH4R515BM	US15	16.80	
DSH4R515A	US15A	16.80	
DSH4R526	US26	16.80	
DSH4R526D	US26D	16.80	

4 1/2" x 4 1/2" / Square Corner

Part Number	Finish	List Price Each	WOOD SCREW #12x1 1/4"
DSH45U3	US3	22.00	
DSH45U4	US4	19.00	
DSH45U5	US5	22.00	
DSH45U10B	US10B	22.00	
DSH45U15	US15	22.00	
DSH45U15A	US15A	22.00	
DSH45U26	US26	22.00	
DSH45U26D	US26D	22.00	
DSH45USPW	White	19.00	
DSH45U32D	US32D	35.80	



Bench Mark
 Stainless Steel

Bench Mark
 Stainless Steel

Spring Hinge / Double Action / Steel

Floor Mounted / Solid Brass Cover Plates & Trim

Part Number	Finish	List Price Each	DOOR THICKS 1 3/8" 1 3/4"	LOAD CAPACITY 90 LBS	CASE QTY 10 PCS
DASH95USP	USP	120.00			
DASH95U3	US3	120.00			
DASH95U5	US5	120.00			
DASH95U10B	US10B	120.00			
DASH95U15	US15	120.00			
DASH95U15A	US15A	120.00			
DASH95U26	US26	120.00			
DASH95U26D	US26D	120.00			
DASH95CR003	CR003	130.00			

Note: Package includes hinge base, cover plates (2), back plate, pivot and screws

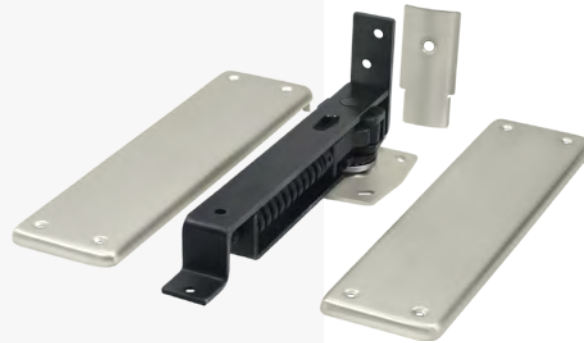

- Adjustable Tension
- Holds Open at 85 ~ 90 degrees
- Universal Handing
- Floor Mounted
- Maximum Door Weight 90 LBS
- Fits doors 1 3/8" ~ 1 3/4"

Top Pivot
For Double Action Spring Hinge / Steel

Part Number	List Price Each
DASH95TP	6.50



Jamb Bracket
For Double Action Spring Hinge / Solid Brass

Part Number	Finish	List Price Each
JB-DASH95USP	USP	15.00
JB-DASH95U3	US3	15.00
JB-DASH95U5	US5	15.00
JB-DASH95U10B	US10B	15.00
JB-DASH95U15	US15	15.00
JB-DASH95U15A	US15A	15.00
JB-DASH95U26	US26	15.00
JB-DASH95U26D	US26D	15.00
JB-DASH95CR003	CR003	15.00



Back Plate
For Double Action Spring Hinges / Steel

Part Number	Finish	List Price Each
DASHBPU3	US3	5.00
DASHBPU5	US5	5.00
DASHBPU10B	US10B	5.00
DASHBPU15	US15	5.00
DASHBPU15A	US15A	5.00
DASHBPU26	US26	5.00
DASHBPU26D	US26D	5.00



Cover Plate
For Double Action Spring Hinge / Solid Brass

Part Number	Finish	List Price Each
DASHCPUSP	USP	20.00
DASHCPU3	US3	20.00
DASHCPU5	US5	20.00
DASHCPU10B	US10B	20.00
DASHCPU15	US15	20.00
DASHCPU15A	US15A	20.00
DASHCPU26	US26	20.00
DASHCPU26D	US26D	20.00
DASHCP003	CR003	22.00



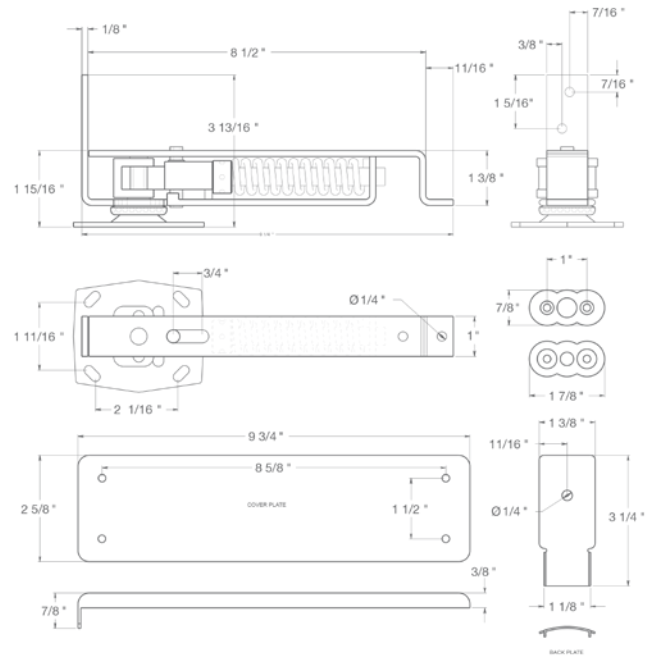

DASH95 Schematics

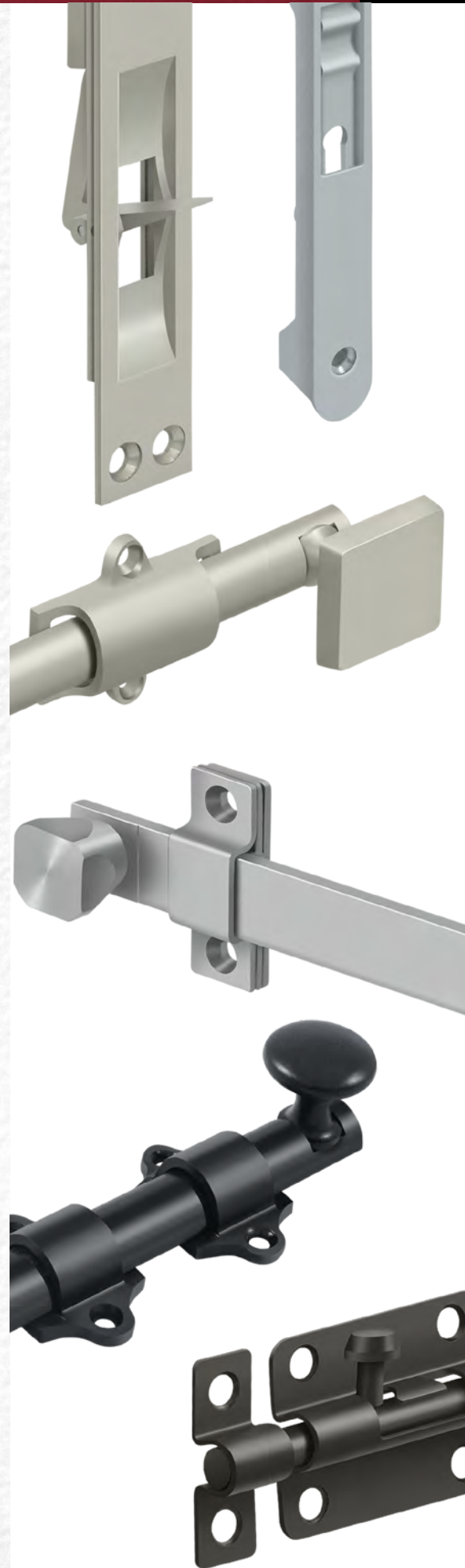

Bolts

	Pages
Extension Flush Bolts.....	4 - 2
Flush Bolts.....	4 - 3
Mortise Bolt.....	4 - 3
Offset Surface Bolts.....	4 - 4
Surface Bolts.....	4 - 5
Concealed Screw Surface Bolts.....	4 - 6
Dutch Door Quadrant.....	4 - 7
Dutch Door Bolt.....	4 - 7
Barrel Bolts, Solid Brass.....	4 - 7
Spring Bolt, Stainless Steel.....	4 - 7
Barrel Bolts, Stainless Steel.....	4 - 8
Security Bolts, HD Stainless Steel.....	4 - 8



 Custom finish plating available.

BOLTS

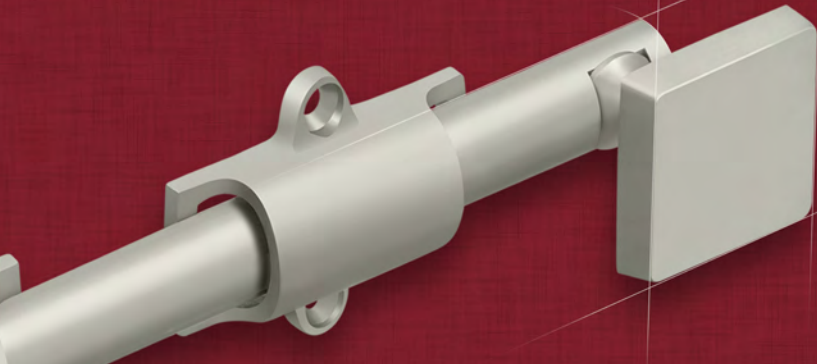

Extension Flush Bolts / Solid Brass

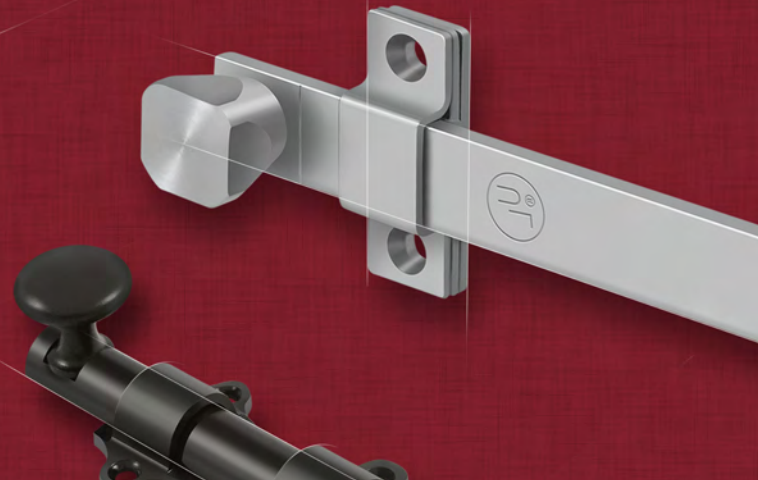

Extension Flush Bolts / Zinc

12" Extension Bolt / 6 3/4"x 1"

Part Number	Finish	List Price Each
12EFB3-UNL	US3-UNL	22.00
12EFB3	US3	22.00
12EFB5	US5	26.00
12EFB10B	US10B	26.00
12EFB15	US15	26.00
12EFB15A	US15A	26.00
12EFB19	US19	26.00
12EFB26	US26	26.00
12EFB26D	US26D	26.00
12EFBCR003	CR003	31.00

ROD EXTENSION	BOX QTY
12"	2 PC

18" Extension Bolt / 6 3/4"x 1"

Part Number	Finish	List Price Each
18EFB3-UNL	US3-UNL	22.00
18EFB3	US3	22.00
18EFB5	US5	26.00
18EFB10B	US10B	26.00
18EFB15	US15	26.00
18EFB15A	US15A	26.00
18EFB19	US19	26.00
18EFB26	US26	26.00
18EFB26D	US26D	26.00
18EFBCR003	CR003	31.00

ROD EXTENSION	BOX QTY
18"	2 PC

24" Extension Bolt / 6 3/4"x 1"

Part Number	Finish	List Price Each
24EFB3-UNL	US3-UNL	22.00
24EFB3	US3	22.00
24EFB5	US5	26.00
24EFB10B	US10B	26.00
24EFB15	US15	26.00
24EFB15A	US15A	26.00
24EFB19	US19	26.00
24EFB26	US26	26.00
24EFB26D	US26D	26.00
24EFBCR003	CR003	31.00

ROD EXTENSION	BOX QTY
24"	2 PC

39" Extension Bolt / 6 3/4"x 1"

Part Number	Finish	List Price Each
39EFB3-UNL	US3-UNL	22.00
39EFB3	US3	22.00
39EFB5	US5	26.00
39EFB10B	US10B	26.00
39EFB15	US15	26.00
39EFB15A	US15A	26.00
39EFB19	US19	26.00
39EFB26	US26	26.00
39EFB26D	US26D	26.00
39EFBCR003	CR003	31.00

ROD EXTENSION	BOX QTY
39"	2 PC

**18" Extension Flush Bolt
7"x 3/4" / Zinc**

Part Number	Finish	List Price Each
18EFBZ3	US3	13.75
18EFBZ5	US5	13.75
18EFBZ10B	US10B	13.75
18EFBZ15	US15	13.75
18EFBZ26D	US26D	13.75

ROUND EDGE	BOX QTY
	50 PC

Note: Fits most of the standard T-Astragal prepped for rounded Extension flush bolts.



Flush Bolts

Mortise Bolt / Dutch Door Quadrant / Dutch Door Bolt

4" Flush Bolt / 4"x 3/4"x 1/8" / Solid Brass

Part Number	Finish	List Price Each	SQUARE EDGE
4FBS3	US3	11.00	BOX QTY 10 PC
4FBS5	US5	13.00	
4FBS10B	US10B	13.00	
4FBS15	US15	13.00	THROW 3/4"
4FBS15A	US15A	13.00	
4FBS19	US19	13.00	
4FBS26	US26	13.00	
4FBS26D	US26D	13.00	
4FBSCR003	CR003	15.00	

6" Flush Bolt / 6"x 3/4"x 1/8" / Solid Brass

Part Number	Finish	List Price Each	SQUARE EDGE
6FBS3-UNL	US3-UNL	14.50	BOX QTY 15 PC
6FBS3	US3	14.50	
6FBS5	US5	18.40	
6FBS10B	US10B	18.40	THROW 1"
6FBS15	US15	18.40	
6FBS15A	US15A	18.40	
6FBS19	US19	18.40	
6FBS26	US26	18.40	
6FBS26D	US26D	18.40	
6FBSCR003	CR003	24.00	
6FBS32D	US32D	22.00	



Stainless Steel

6" Flush Bolt / 6"x 3/4"x 1/8" / Solid Brass

Part Number	Finish	List Price Each	ROUND EDGE
6FBR3	US3	14.50	BOX QTY 15 PC
6FBR5	US5	18.40	
6FBR10B	US10B	18.40	
6FBR15	US15	18.40	THROW 1"
6FBR15A	US15A	18.40	
6FBR19	US19	18.40	
6FBR26	US26	18.40	
6FBR26D	US26D	18.40	
6FBR003	CR003	24.00	

7" Flush Bolt / 7"x 3/4"x 1/8" / Solid Brass

Part Number	Finish	List Price Each	ROUND EDGE
7FBR3	US3	18.00	BOX QTY 15 PC
7FBR5	US5	22.00	
7FBR10B	US10B	22.00	
7FBR15	US15	22.00	THROW 1"
7FBR15A	US15A	22.00	
7FBR19	US19	22.00	
7FBR26	US26	22.00	
7FBR26D	US26D	22.00	
7FBR003	CR003	26.50	

7" Flush Bolt / 7"x 3/4"x 1/8" / Zinc

Part Number	Finish	List Price Each	ROUND EDGE
7FBZ3	US3	12.00	BOX QTY 50 PC
7FBZ5	US5	12.00	
7FBZ10B	US10B	12.00	
7FBZ15	US15	12.00	THROW 3/4"
7FBZ15A	US15A	12.00	
7FBZ26D	US26D	12.00	

2 1/2" Mortise Bolt / Solid Brass

Part Number	Finish	List Price Each	BOX QTY 15 PC
MB175U3	US3	9.40	CASE QTY 150 PC
MB175U5	US5	10.00	
MB175U10B	US10B	10.00	
MB175U15	US15	10.00	THROW 7/16"
MB175U15A	US15A	10.00	
MB175U19	US19	10.00	
MB175U26	US26	10.00	
MB175U26D	US26D	10.00	
MB175CR003	CR003	11.50	

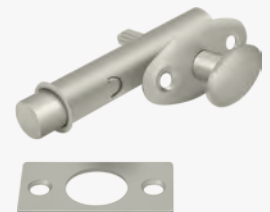

Offset Surface Bolts / Heavy Duty / Solid Brass

10" Offset Surface Bolt

Part Number	Finish	List Each	CASE QTY 30 PC
FPG103	US3	51.00	
FPG105	US5	61.00	
FPG1010B	US10B	61.00	
FPG1014	US14	61.00	
FPG1015	US15	61.00	
FPG1015A	US15A	61.00	
FPG1019	US19	61.00	
FPG1026	US26	61.00	
FPG1026D	US26D	61.00	
FPG10CR003	CR003	66.00	



Offset and Surface Bolts include 3 strikes: Universal, Mortise and Angle strikes with matching solid brass screws that are packaged in individual poly bags.

The surface bolt is designed with a unique ball bearing tension system that will hold the bolt in place in any position.

Width of Bolt: 5/8" diameter, half-round rod
 Width of Guide: 1 1/2"
 Diameter of Knob: 1 1/4"

18" Offset Surface Bolt

Part Number	Finish	List Each	CASE QTY 30 PC
FPG183	US3	80.00	
FPG185	US5	85.00	
FPG1810B	US10B	85.00	
FPG1815	US15	85.00	
FPG1815A	US15A	85.00	
FPG1819	US19	85.00	
FPG1826	US26	85.00	
FPG1826D	US26D	85.00	

26" Offset Surface Bolt

Part Number	Finish	List Each	CASE QTY 20 PC
FPG263	US3	101.00	
FPG265	US5	112.00	
FPG2610B	US10B	112.00	
FPG2615	US15	112.00	
FPG2615A	US15A	112.00	
FPG2619	US19	112.00	
FPG2626	US26	112.00	
FPG2626D	US26D	112.00	
FPG26CR003	CR003	126.00	

42" Offset Surface Bolt

Part Number	Finish	List Each	CASE QTY 10 PC
FPG423	US3	148.00	
FPG425	US5	166.00	
FPG4210B	US10B	166.00	
FPG4215	US15	166.00	
FPG4215A	US15A	166.00	
FPG4219	US19	166.00	
FPG4226	US26	166.00	
FPG4226D	US26D	166.00	
FPG42CR003	CR003	190.00	

Additional Sizes by Special Order

Part Number	Finish	Size	List Price Each	CASE QTY 30 PC
FPG610B	US10B	6"x 5/8"	54.00	
FPG1210B	US10B	12"x 5/8"	80.00	
FPG1226	US26	12"x 5/8"	80.00	
FPG2410B	US10B	24"x 5/8"	108.00	



Mortise Strike Angle Strike Universal Strike

All Strikes and mounting screws are included in the same finish as your bolt.

Surface Bolt Accessories, Sold Separately

Square Knob / Solid Brass

Part Number	Finish	List Each
KBSU3	US3	5.00
KBSU5	US5	6.00
KBSU10B	US10B	6.00
KBSU14	US14	6.00
KBSU15	US15	6.00
KBSU15A	US15A	6.00
KBSU19	US19	6.00
KBSU26	US26	6.00
KBSU26D	US26D	6.00
KBSCR003	CR003	8.00

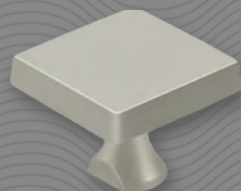

Square Knob Width: 1 1/8"

Offset Heavy Duty Strike / Solid Brass

Part Number	Finish	List Each
FPGHDBU5	US5	8.00
FPGHDBU10B	US10B	8.00
FPGHDBU14	US14	8.00
FPGHDBU15	US15	8.00
FPGHDBU15A	US15A	8.00
FPGHDBU26	US26	8.00
FPGHDBCR003	CR003	9.00

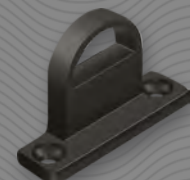

Surface Bolts / Heavy Duty / Solid Brass

6" Surface Bolt

Part Number	Finish	List Price Each	BOX QTY
6SB3-UNL	US3-UNL	35.00	4 PC
6SB3	US3	35.00	
6SB5	US5	40.00	CASE QTY 40 PC
6SB10B	US10B	40.00	
6SB14	US14	40.00	
6SB15	US15	40.00	
6SB15A	US15A	40.00	
6SB19	US19	40.00	
6SB26	US26	40.00	
6SB26D	US26D	40.00	
6SB003	CR003	46.00	

8" Surface Bolt

Part Number	Finish	List Price Each	BOX QTY
8SB3-UNL	US3-UNL	41.00	10 PC
8SB3	US3	41.00	
8SB5	US5	48.00	CASE QTY 30 PC
8SB10B	US10B	48.00	
8SB15	US15	48.00	
8SB15A	US15A	48.00	
8SB19	US19	48.00	
8SB26	US26	48.00	
8SB26D	US26D	48.00	
8SB003	CR003	54.00	

12" Surface Bolt

Part Number	Finish	List Price Each	BOX QTY
12SB3-UNL	US3-UNL	48.00	10 PC
12SB3	US3	48.00	
12SB5	US5	58.00	CASE QTY 30 PC
12SB10B	US10B	58.00	
12SB14	US14	58.00	
12SB15	US15	58.00	
12SB15A	US15A	58.00	
12SB19	US19	58.00	
12SB26	US26	58.00	
12SB26D	US26D	58.00	
12SB003	CR003	66.00	

18" Surface Bolt

Part Number	Finish	List Price Each	BOX QTY
18SB3-UNL	US3-UNL	68.00	10 PC
18SB3	US3	68.00	
18SB5	US5	76.00	CASE QTY 30 PC
18SB10B	US10B	76.00	
18SB15	US15	76.00	
18SB15A	US15A	76.00	
18SB19	US19	76.00	
18SB26	US26	76.00	
18SB26D	US26D	76.00	
18SB003	CR003	83.00	

24" Surface Bolt

Part Number	Finish	List Price Each	BOX QTY
24SB3-UNL	US3-UNL	79.00	10 PC
24SB3	US3	79.00	
24SB5	US5	89.00	CASE QTY 30 PC
24SB10B	US10B	89.00	
24SB15	US15	89.00	
24SB15A	US15A	89.00	
24SB19	US19	89.00	
24SB26	US26	89.00	
24SB26D	US26D	89.00	
24SB003	CR003	102.00	



Surface Bolt Accessories Sold Separately

Square Knob / Solid Brass

Part Number	Finish	List Each
KBSU3	US3	5.00
KBSU5	US5	6.00
KBSU10B	US10B	6.00
KBSU14	US14	6.00
KBSU15	US15	6.00
KBSU15A	US15A	6.00
KBSU19	US19	6.00
KBSU26	US26	6.00
KBSU26D	US26D	6.00
KBSCR003	CR003	8.00

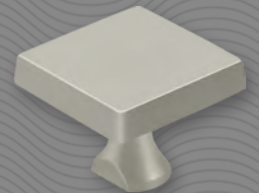

Square Knob Width: 1 1/8"



Mortise Strike Angle Strike Universal Strike

All Strikes and mounting screws are included in the same finish as your bolt.

Concealed Screw Surface Bolts / Solid Brass

2"

Part Number	Finish	List Price Each	BOX QTY 25 PC
2SBCS3	US3	10.20	CASE QTY 250
2SBCS5	US5	11.50	
2SBCS10B	US10B	11.50	
2SBCS15	US15	11.50	
2SBCS15A	US15A	11.50	
2SBCS19	US19	11.50	
2SBCS26	US26	11.50	
2SBCS26D	US26D	11.50	
2SBCS003	CR003	12.80	

4"

Part Number	Finish	List Price Each	BOX QTY 25 PC
4SBCS3	US3	12.80	CASE QTY 250 PC
4SBCS5	US5	14.90	
4SBCS10B	US10B	14.90	
4SBCS15	US15	14.90	
4SBCS15A	US15A	14.90	
4SBCS19	US19	14.90	
4SBCS26	US26	14.90	
4SBCS26D	US26D	14.90	
4SBCS003	CR003	16.00	

6"

Part Number	Finish	List Price Each	BOX QTY 15 PC
6SBCS3	US3	14.00	CASE QTY 150
6SBCS5	US5	17.90	
6SBCS10B	US10B	17.90	
6SBCS15	US15	17.90	
6SBCS15A	US15A	17.90	
6SBCS19	US19	17.90	
6SBCS26	US26	17.90	
6SBCS26D	US26D	17.90	
6SBCS003	CR003	20.20	

8"

Part Number	Finish	List Price Each	BOX QTY 10 PC
8SBCS3	US3	18.00	CASE QTY 100 PC
8SBCS5	US5	22.40	
8SBCS10B	US10B	22.40	
8SBCS15	US15	22.40	
8SBCS15A	US15A	22.40	
8SBCS19	US19	22.40	
8SBCS26	US26	22.40	
8SBCS26D	US26D	22.40	
8SBCS003	CR003	24.00	

12"

Part Number	Finish	List Price Each	BOX QTY 10 PC
12SBCS3	US3	22.80	CASE QTY 50 PC
12SBCS5	US5	26.30	
12SBCS10B	US10B	26.30	
12SBCS15	US15	26.30	
12SBCS15A	US15A	26.30	
12SBCS19	US19	26.30	
12SBCS26	US26	26.30	
12SBCS26D	US26D	26.30	
12SBCS003	CR003	27.50	



Concealed Screw Surface Bolts and matching hardware are packed in individual poly bags.

Each Concealed Screw Surface Bolt includes 3 strikes: Universal, Mortise and Angle strikes with matching solid brass Phillip's head screws.

Knob diameter: 5/8"

Fully concealed screw design improves security and appearance.

The surface bolt is designed with a unique ball bearing tension system that will hold the bolt in place in any position.



Barrel Bolts / Stainless Steel

Barrel Bolts / Stainless Steel / US32D

Part Number	Size	List Price Each	BOX QTY
4BB32D	4"	18.00	10 PC
6BB32D	6"	27.00	CASE QTY 100 PC
8BB32D	8"	37.00	
10BB32D	10"	46.00	
12BB32D	12"	49.00	

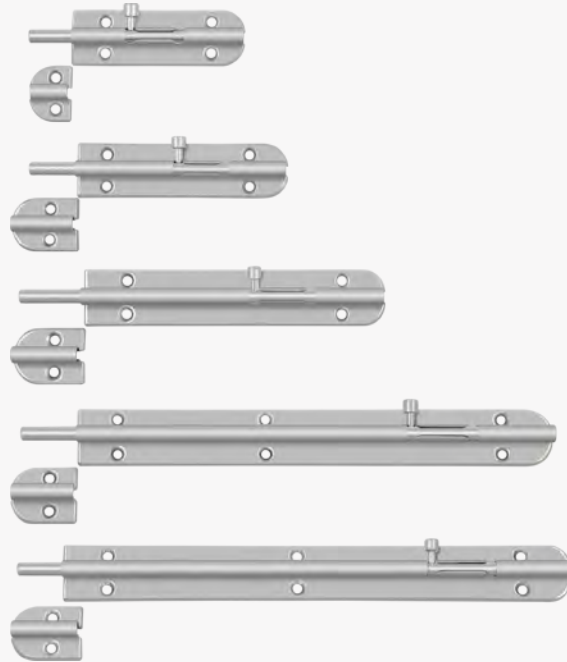

Security Bolts / Heavy Duty / Stainless Steel

Security Bolt / Heavy Duty / Stainless Steel

Part Number	Dimensions	List Price Each
6SSB32D	6"x 3/4"	42.00
8SSB32D	8"x 3/4"	51.00
10SSB32D	10"x 3/4"	60.00
12SSB32D	12"x 3/4"	65.00



Bumpers & Stops

	Pages
Magnetic Door Holder / Stop.....	5 - 2
Baseboard Door Bumpers.....	5 - 2
Dome Stops & Magnetic Dome Stop.....	5 - 3
Universal Floor Bumpers.....	5 - 4
Kickdown Holders.....	5 - 5
Floor Door Bumpers.....	5 - 5
Wall Mount Bumpers.....	5 - 5
Floor Mount Bumpers.....	5 - 6
Flush Mount Bumpers.....	5 - 6
Hinge Pin Stops.....	5 - 7
Extended Button Tip.....	5 - 8
Overhead Door Stop & Holder.....	5 - 8
Crash Chain.....	5 - 8
Transom Chain.....	5 - 8
Security Pin.....	5 - 8



▶ Custom finish plating available.

BUMPERS & STOPS



Magnetic Door Stop & Holders / Baseboard Door Bumpers / Solid Brass

3" Stop & Holder / Magnetic

Part Number	Finish	List Price Each	BOX QTY 10 PC
MDH30U3	US3	25.00	CASE QTY 100 PC
MDH30U5	US5	27.00	
MDH30U10B	US10B	27.00	
MDH30U15	US15	27.00	
MDH30U15A	US15A	27.00	
MDH30U19	US19	27.00	
MDH30U26	US26	27.00	
MDH30U26D	US26D	27.00	
MDH30CR003	CR003	29.00	



4 1/2" Extendable Baseboard Door Bumper

Part Number	Finish	List Price Each	BOX QTY 25 PC
BDS450U3	US3	16.80	CASE QTY 100 PC
BDS450U4	US4	18.50	
BDS450U5	US5	18.50	
BDS450U10B	US10B	18.50	
BDS450U14	US14	18.50	
BDS450U15	US15	18.50	
BDS450U15A	US15A	18.50	
BDS450U19	US19	18.50	
BDS450U26	US26	18.50	
BDS450U26D	US26D	18.50	
BDS450CR003	CR003	20.00	FULL LENGTH 4 1/2"



3 1/2" Stop & Holder / Magnetic

Part Number	Finish	List Price Each	BOX QTY 5 PC
MDH35U3	US3	36.00	CASE QTY 50 PC
MDH35U5	US5	41.00	
MDH35U10B	US10B	41.00	
MDH35U15	US15	41.00	
MDH35U15A	US15A	41.00	
MDH35U19	US19	41.00	
MDH35U26	US26	41.00	
MDH35U26D	US26D	41.00	
MDH35CR003	CR003	44.50	



3 1/2" Baseboard Door Bumper / Solid Brass

Part Number	Finish	List Price Each	BOX QTY 30 PC
BDH35U3	US3	25.50	CASE QTY 300 PC
BDH35U5	US5	27.50	
BDH35U10B	US10B	27.50	
BDH35U15	US15	27.50	
BDH35U15A	US15A	27.50	
BDH35U19	US19	27.50	
BDH35U26	US26	27.50	
BDH35U26D	US26D	27.50	
BDH35CR003	CR003	29.50	



2 1/2" Flush Stop & Holder / Magnetic

Part Number	Finish	List Price Each	BOX QTY 10 PC
MDHF25U3	US3	35.00	CASE QTY 100 PC
MDHF25U5	US5	37.00	
MDHF25U10B	US10B	37.00	
MDHF25U15	US15	37.00	
MDHF25U15A	US15A	37.00	
MDHF25U19	US19	37.00	
MDHF25U26	US26	37.00	
MDHF25U26D	US26D	37.00	
MDHF25CR003	CR003	40.00	



2 1/2" Flush Stop & Holder / Card Pack

Part Number	Finish	List Price Each
MDHF25BP3	US3	37.00
MDHF25BP5	US5	39.00
MDHF25BP10B	US10B	39.00
MDHF25BP15	US15	39.00
MDHF25BP26	US26	39.00



Baseboard Door Bumpers

4" Baseboard Door Bumper

Part Number	Finish	List Each	BOX QTY
BDS425U3-UNL	US3-UNL	10.30	10 PC
BDS425U3	US3	10.30	
BDS425U5	US5	11.20	
BDS425U10B	US10B	11.20	CASE QTY
BDS425U14	US14	11.20	200 PC
BDS425U15	US15	11.20	
BDS425U15A	US15A	11.20	
BDS425U19	US19	11.20	
BDS425U26	US26	11.20	
BDS425U26D	US26D	11.20	
BDS425CR003	CR003	13.50	



3 1/4" Baseboard Door Bumper

Part Number	Finish	List Price Each	BOX QTY
BDS30U3-UNL	US3-UNL	7.90	10 PC
BDS30U3	US3	7.90	
BDS30U4	US4	8.80	
BDS30U5	US5	8.80	CASE QTY
BDS30U10B	US10B	8.80	200 PC
BDS30U14	US14	8.80	
BDS30U15	US15	8.80	
BDS30U15A	US15A	8.80	
BDS30U19	US19	8.80	
BDS30U26	US26	8.80	
BDS30U26D	US26D	8.80	
BDS30CR003	CR003	9.80	



1 1/2" Baseboard Door Bumper

Part Number	Finish	List Each	BOX QTY
BDS125U3	US3	4.90	40 PC
BDS125U5	US5	6.20	
BDS125U10B	US10B	6.20	CASE QTY
BDS125U15	US15	6.20	400 PC
BDS125U15A	US15A	6.20	
BDS125U19	US19	6.20	
BDS125U26	US26	6.20	
BDS125U26D	US26D	6.20	
BDS125CR003	CR003	7.20	



3" Baseboard Door Bumper / Zinc Rigid

Part Number	Finish	List Price Each	BOX QTY
ZBDS30U3	US3	2.15	30 PC
ZBDS30U5	US5	2.15	
ZBDS30U10B	US10B	2.15	CASE QTY
ZBDS30U15	US15	2.15	300 PC
ZBDS30U15A	US15A	2.15	
ZBDS30U26	US26	2.15	
ZBDS30U26D	US26D	2.15	



3" Baseboard Door Bumper / Steel Spring

Part Number	Finish	List Each	BOX QTY
SDS3U3	US3	0.95	50 PC
SDS3U5	US5	0.95	
SDS3U26	US26	0.95	CASE QTY
			500 PC



Black Rubber Tip Available

 3 3/4" Baseboard Door Bumper
Steel Spring / Heavy Duty

Part Number	Finish	List Price Each	BOX QTY
SDS375U3	US3	1.18	50 PC
SDS375U5	US5	1.18	
SDS375U10B	US10B	1.18	CASE QTY
SDS375U14	US14	1.18	500 PC
SDS375U15	US15	1.18	
SDS375U15A	US15A	1.18	
SDS375U26	US26	1.18	



Dome Stops / Solid Brass

1" Low Profile Dome Stop

Part Number	Finish	List Price Each	BOX QTY
DSL316U3	US3	8.00	10 PC
DSL316U5	US5	8.80	
DSL316U10B	US10B	8.80	CASE QTY
DSL316U14	US14	8.80	200 LB
DSL316U15	US15	8.80	
DSL316U15A	US15A	8.80	CASE WEIGHT
DSL316U19	US19	8.80	38 LB
DSL316U26	US26	8.80	
DSL316U26D	US26D	8.80	
DSL316CR003	CR003	10.00	



1 3/8" High Profile Dome Stop

Part Number	Finish	List Price Each	BOX QTY
DSHP916U3	US3	10.80	10 PC
DSHP916U5	US5	11.50	
DSHP916U10B	US10B	11.50	CASE QTY
DSHP916U15	US15	11.50	200 PC
DSHP916U15A	US15A	11.50	
DSHP916U19	US19	11.50	
DSHP916U26	US26	11.50	CASE WEIGHT
DSHP916U26D	US26D	11.50	48 LB
DSHP916CR003	CR003	12.70	



1 3/8" Magnetic Dome Stop & Catch

Part Number	Finish	List Price Each	BOX QTY
DSM125U3	US3	28.50	10 PC
DSM125U5	US5	30.50	
DSM125U10B	US10B	30.50	CASE QTY
DSM125U15	US15	30.50	100 PC
DSM125U15A	US15A	30.50	
DSM125U19	US19	30.50	
DSM125U26	US26	30.50	CASE WEIGHT
DSM125U26D	US26D	30.50	31 LB
DSM125CR003	CR003	32.50	
SS DSM125U32	US32	33.00	
SS DSM125U32D	US32D	33.00	

SS Stainless Steel

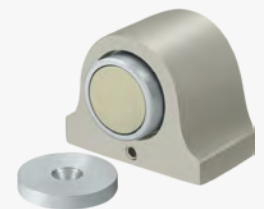

Universal Floor Bumpers / Solid Brass

1 3/8" Square Universal Floor Bumper

Part Number	Finish	List Each	BOX QTY
UFBS138U3-UNL	US3-UNL	20.00	20 PC
UFBS138U3	US3	20.00	CASE QTY 100 PC
UFBS138U4	US4	22.00	
UFBS138U5	US5	22.00	CASE WEIGHT 36 LB
UFBS138U10B	US10B	22.00	
UFBS138U14	US14	22.00	
UFBS138U15	US15	22.00	
UFBS138U15A	US15A	22.00	
UFBS138U19	US19	22.00	
UFBS138U26	US26	22.00	
UFBS138U26D	US26D	22.00	
UFBS138CR003	CR003	24.00	

2" Universal Floor Bumper / Card Pack

Part Number	Finish	List Each
UFB5000BP3	US3	23.00
UFB5000BP5	US5	25.00
UFB5000BP10B	US10B	25.00
UFB5000BP15	US15	25.00
UFB5000BP26	US26	25.00

1 1/2" Flat Universal Floor Bumper

Part Number	Finish	List Each	BOX QTY
UFB4505U3	US3	17.00	20 PC
UFB4505U3-UNL	US3-UNL	17.00	CASE QTY 100 PC
UFB4505U4	US4	19.00	
UFB4505U5	US5	19.00	CASE WEIGHT 40 LB
UFB4505U10B	US10B	19.00	
UFB4505U14	US14	19.00	
UFB4505U15	US15	19.00	
UFB4505U15A	US15A	19.00	
UFB4505U19	US19	19.00	
UFB4505U26	US26	19.00	
UFB4505U26D	US26D	19.00	
UFB4505CR003	CR003	21.50	

2" Flat Universal Floor Bumper

Part Number	Finish	List Each	BOX QTY
UFB5000U3-UNL	US3-UNL	20.00	15 PC
UFB5000U3	US3	20.00	CASE QTY 75 PC
UFB5000U4	US4	22.00	
UFB5000U5	US5	22.00	CASE WEIGHT 50 LB
UFB5000U10B	US10B	22.00	
UFB5000U14	US14	22.00	
UFB5000U15	US15	22.00	
UFB5000U15A	US15A	22.00	
UFB5000U19	US19	22.00	
UFB5000U26	US26	22.00	
UFB5000U26D	US26D	22.00	
UFB5000CR003	CR003	23.00	

1 5/8" Dome Universal Floor Bumper

Part Number	Finish	List Each	BOX QTY
UFBD4505U3	US3	19.50	15 PC
UFBD4505U5	US5	20.50	CASE QTY 90 PC
UFBD4505U10B	US10B	20.50	
UFBD4505U15	US15	20.50	CASE WEIGHT 40 LB
UFBD4505U15A	US15A	20.50	
UFBD4505U19	US19	20.50	
UFBD4505U26	US26	20.50	
UFBD4505U26D	US26D	20.50	
UFBD4505CR003	CR003	22.50	

2" Dome Universal Floor Bumper

Part Number	Finish	List Each	BOX QTY
UFBD5000U3	US3	21.50	15 PC
UFBD5000U5	US5	22.50	CASE QTY 90 PC
UFBD5000U10B	US10B	22.50	
UFBD5000U15	US15	22.50	CASE WEIGHT 50 LB
UFBD5000U15A	US15A	22.50	
UFBD5000U19	US19	22.50	
UFBD5000U26	US26	22.50	
UFBD5000U26D	US26D	22.50	
UFBD5000CR003	CR003	24.00	

1 5/8" Pattern Universal Floor Bumper

Part Number	Finish	List Each	BOX QTY
UFBP4505U3	US3	19.50	15 PC
UFBP4505U5	US5	20.50	CASE QTY 90 PC
UFBP4505U10B	US10B	20.50	
UFBP4505U15	US15	20.50	CASE WEIGHT 40 LB
UFBP4505U15A	US15A	20.50	
UFBP4505U19	US19	20.50	
UFBP4505U26	US26	20.50	
UFBP4505U26D	US26D	20.50	
UFBP4505CR003	CR003	22.50	

2" Pattern Universal Floor Bumper

Part Number	Finish	List Each	BOX QTY
UFBP5000U3	US3	21.50	15 PC
UFBP5000U5	US5	22.50	CASE QTY 90 PC
UFBP5000U10B	US10B	22.50	
UFBP5000U15	US15	22.50	CASE WEIGHT 50 LB
UFBP5000U15A	US15A	22.50	
UFBP5000U19	US19	22.50	
UFBP5000U26	US26	22.50	
UFBP5000U26D	US26D	22.50	
UFBP5000CR003	CR003	24.00	



Kickdown Holders / Solid Brass

Floor Door Bumpers / Solid Brass

5" Kickdown Holder

Part Number	Finish	List Price Each	BOX QTY 10 PC
DHK5U3	US3	23.50	CASE QTY 100 PC
DHK5U5	US5	24.80	
DHK5U10B	US10B	24.80	CASE WEIGHT 48 LB
DHK5U15	US15	24.80	
DHK5U15A	US15A	24.80	
DHK5U19	US19	24.80	
DHK5U26	US26	24.80	
DHK5U26D	US26D	24.80	
DHK5CR003	CR003	27.00	



1 3/8" Floor Door Bumper

Part Number	Finish	List Price Each	BOX QTY 30 PC
FDB138U3	US3	10.00	CASE QTY 300 PC
FDB138U3-UNL	US3-UNL	10.00	
FDB138U5	US5	11.00	CASE WEIGHT 46 LB
FDB138U10B	US10B	11.00	
FDB138U14	US14	11.00	
FDB138U15	US15	11.00	
FDB138U15A	US15A	11.00	
FDB138U19	US19	11.00	
FDB138U26	US26	11.00	
FDB138U26D	US26D	11.00	
FDB138CR003	CR003	12.00	



4" Kickdown Holder

Part Number	Finish	List Price Each	BOX QTY 10 PC
DHK4U3	US3	22.00	CASE QTY 100 PC
DHK4U5	US5	23.00	
DHK4U10B	US10B	23.00	CASE WEIGHT 56 LB
DHK4U15	US15	23.00	
DHK4U15A	US15A	23.00	
DHK4U19	US19	23.00	
DHK4U26	US26	23.00	
DHK4U26D	US26D	23.00	
DHK4CR003	CR003	25.50	



2 1/8" Floor Door Bumper

Part Number	Finish	List Price Each	BOX QTY 10 PC
FDB218U3	US3	20.00	CASE QTY 100 PC
FDB218U3-UNL	US3-UNL	20.00	
FDB218U5	US5	21.50	CASE WEIGHT 48 LB
FDB218U10B	US10B	21.50	
FDB218U15	US15	21.50	
FDB218U15A	US15A	21.50	
FDB218U19	US19	21.50	
FDB218U26	US26	21.50	
FDB218U26D	US26D	21.50	
FDB218CR003	CR003	23.50	



7" Heavy Duty Kickdown Holder

Part Number	Finish	List Price Each	BOX QTY 5 PC
DHK7U3	US3	42.00	CASE QTY 25 PC
DHK7U5	US5	45.00	
DHK7U10B	US10B	45.00	CASE WEIGHT 27 LB
DHK7U15	US15	45.00	
DHK7U26	US26	45.00	
DHK7U26D	US26D	45.00	



2 7/8" Floor Door Bumper

Part Number	Finish	List Price Each	BOX QTY 10 PC
FDB278U3	US3	21.00	CASE QTY 100 PC
FDB278U3-UNL	US3-UNL	21.00	
FDB278U5	US5	23.00	CASE WEIGHT 50 LB
FDB278U10B	US10B	23.00	
FDB278U14	US14	23.00	
FDB278U15	US15	23.00	
FDB278U15A	US15A	23.00	
FDB278U19	US19	23.00	
FDB278U26	US26	23.00	
FDB278U26D	US26D	23.00	
FDB278CR003	CR003	24.80	



3" Extension

Wall Mount Bumpers / Solid Brass

3 5/8" Projection

Part Number	Finish	List Price Each	BOX QTY 5 PC
DSW325U3	US3	39.00	CASE QTY 50 PC
DSW325U5	US5	40.00	
DSW325U10B	US10B	40.00	CASE WEIGHT 50 LB
DSW325U15	US15	40.00	
DSW325U15A	US15A	40.00	
DSW325U19	US19	40.00	
DSW325U26	US26	40.00	
DSW325U26D	US26D	40.00	
DSW325CR003	CR003	44.00	



3 5/8" Projection / With Holder

Part Number	Finish	List Price Each	BOX QTY 5 PC
SAHW325U3	US3	42.00	CASE QTY 50 PC
SAHW325U5	US5	44.00	
SAHW325U10B	US10B	44.00	CASE WEIGHT 62 LB
SAHW325U15	US15	44.00	
SAHW325U15A	US15A	44.00	
SAHW325U19	US19	44.00	
SAHW325U26	US26	44.00	
SAHW325U26D	US26D	44.00	
SAHW325CR003	CR003	47.00	

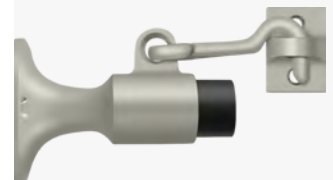

Floor Mount Bumpers / Solid Brass

8" Heavy Duty Floor Bumper / With Holder

Part Number	Finish	List Price Each	BOX QTY
DSF830U10B	US10B	109.00	1 PC
DSF830U15	US15	109.00	1 PC
			CASE QTY
			20 PC
			CASE WEIGHT
			48 LB



3" Heavy Duty Floor Bumper

Part Number	Finish	List Price Each	BOX QTY
DSF3225U3	US3	37.00	5 PC
DSF3225U5	US5	39.00	5 PC
DSF3225U10B	US10B	39.00	25 PC
DSF3225U15	US15	39.00	25 PC
DSF3225U15A	US15A	39.00	25 PC
DSF3225U19	US19	39.00	25 PC
DSF3225U26	US26	39.00	25 PC
DSF3225U26D	US26D	39.00	25 PC
DSF3225CR003	CR003	42.00	25 PC



6" Heavy Duty Floor Bumper

Part Number	Finish	List Price Each	BOX QTY
DSF600U3	US3	82.00	1 PC
DSF600U5	US5	85.00	1 PC
DSF600U10B	US10B	85.00	10 PC
DSF600U15	US15	85.00	10 PC
DSF600U15A	US15A	85.00	10 PC
DSF600U19	US19	85.00	10 PC
DSF600U26	US26	85.00	10 PC
DSF600U26D	US26D	85.00	10 PC
DSF600CR003	CR003	90.00	10 PC



3 3/4" Heavy Duty Floor Bumper / With Holder

Part Number	Finish	List Price Each	BOX QTY
SAHF358U3	US3	45.00	5 PC
SAHF358U5	US5	47.00	5 PC
SAHF358U10B	US10B	47.00	25 PC
SAHF358U15	US15	47.00	25 PC
SAHF358U15A	US15A	47.00	25 PC
SAHF358U19	US19	47.00	25 PC
SAHF358U26	US26	47.00	25 PC
SAHF358U26D	US26D	47.00	25 PC
SAHF358CR003	CR003	53.00	25 PC



6" Heavy Duty Floor Bumper / With Holder

Part Number	Finish	List Price Each	BOX QTY
DSF630U3	US3	86.00	1 PC
DSF630U5	US5	90.00	1 PC
DSF630U10B	US10B	90.00	10 PC
DSF630U15	US15	90.00	10 PC
DSF630U15A	US15A	90.00	10 PC
DSF630U19	US19	90.00	10 PC
DSF630U26	US26	90.00	10 PC
DSF630U26D	US26D	90.00	10 PC
DSF630CR003	CR003	95.00	10 PC



3 3/4" Cement Mount Heavy Duty Floor Bumper / With Holder

Part Number	Finish	List Price Each	CASE QTY
DSF444U3	US3	45.00	5 PC
DSF444U5	US5	47.00	5 PC
DSF444U10B	US10B	47.00	25 PC
DSF444U15	US15	47.00	25 PC
DSF444U15A	US15A	47.00	25 PC
DSF444U19	US19	47.00	25 PC
DSF444U26	US26	47.00	25 PC
DSF444U26D	US26D	47.00	25 PC
DSF444CR003	CR003	53.00	25 PC



Flush Bumpers / Wall Mount / Solid Brass

1" Diameter Flush Bumper

Part Number	Finish	List Price Each	BOX QTY
WB100U3	US3	4.00	50 PC
WB100U5	US5	5.00	50 PC
WB100U10B	US10B	5.00	500 PC
WB100U15	US15	5.00	500 PC
WB100U15A	US15A	5.00	500 PC
WB100U26	US26	5.00	500 PC
WB100U26D	US26D	5.00	500 PC
WB100CR003	CR003	7.10	500 PC



1 7/8" Diameter Flush Bumper

Part Number	Finish	List Price Each	BOX QTY
WB178U3	US3	7.40	20 PC
WB178U5	US5	8.00	20 PC
WB178U10B	US10B	8.00	200 PC
WB178U15	US15	8.00	200 PC
WB178U15A	US15A	8.00	200 PC
WB178U26	US26	8.00	200 PC
WB178U26D	US26D	8.00	200 PC
WB178CR003	CR003	9.00	200 PC



Flush Bumpers / Wall Mount

Hinge Pin Stops

Solid Brass
2 3/8" Diameter Concave Flush Bumper

Part Number	Finish	List Each	BOX QTY	CASE QTY	CASE WEIGHT
WB238U3	US3	11.00	50 PC		
WB238U5	US5	12.50			
WB238U10B	US10B	12.50		150 PC	
WB238U15	US15	12.50			
WB238U15A	US15A	12.50			40 LB
WB238U26	US26	12.50			
WB238U26D	US26D	12.50			
WB238CR003	CR003	14.00			

Solid Brass
2 3/8" Diameter Convex Flush Bumper

Part Number	Finish	List Each	CASE QTY	CASE WEIGHT
WBC238U3	US3	11.00	50 PC	
WBC238U5	US5	12.50		
WBC238U10B	US10B	12.50	150 PC	
WBC238U15	US15	12.50		
WBC238U15A	US15A	12.50		40 LB
WBC238U26	US26	12.50		
WBC238U26D	US26D	12.50		
WBC238CR003	CR003	14.00		

Solid Brass
2 1/2" Diameter Concave Flush Bumper

Part Number	Finish	List Each	BOX QTY	CASE QTY	CASE WEIGHT
WB250U3	US3	5.50	50 PC		
WB250U5	US5	6.00			
WB250U10B	US10B	6.00		200 PC	
WB250U15	US15	6.00			
WB250U15A	US15A	6.00			36 LB
WB250U26	US26	6.00			
WB250CR003	CR003	7.00			
SS WB250U32D	US32D	6.00			

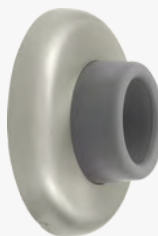
Solid Brass
2 1/2" Diameter Convex Flush Bumper

Part Number	Finish	List Each	BOX QTY	CASE QTY	CASE WEIGHT
WBC250U3	US3	5.50	50 PC		
WBC250U5	US5	6.00			
WBC250U10B	US10B	6.00		200 PC	
WBC250U15	US15	6.00			
WBC250U15A	US15A	6.00			36 LB
WBC250U26	US26	6.00			
WBC250CR003	CR003	7.00			
SS WBC250U32D	US32D	6.00			



SS Stainless Steel

Solid Brass for Solid Brass & Steel Hinges

Part Number	Finish	List Each	BOX QTY	CASE QTY	CASE WEIGHT
HP70U3-UNL	US3-UNL	6.00	30 PC		
HP70U3	US3	6.00			
HP70U4	US4	6.80		300 PC	
HP70U5	US5	6.80			
HP70U10B	US10B	6.80			25 LB
HP70U14	US14	6.80			
HP70U15	US15	6.80			
HP70U15A	US15A	6.80			
HP70U19	US19	6.80			
HP70U26	US26	6.80			
HP70U26D	US26D	6.80			
HP70CR003	CR003	7.50			

Solid Brass for Solid Brass & Steel Hinges

Part Number	Finish	List Each	BOX QTY	CASE QTY	CASE WEIGHT
HPA69U3	US3	8.50	30 PC		
HPA69U5	US5	9.00			
HPA69U10B	US10B	9.00		300 PC	
HPA69U14	US14	9.00			
HPA69U15	US15	9.00			25 LB
HPA69U15A	US15A	9.00			
HPA69U19	US19	9.00			
HPA69U26	US26	9.00			
HPA69U26D	US26D	9.00			
HPA69CR003	CR003	9.60			

Solid Brass for Steel Hinges

Part Number	Finish	List Each	BOX QTY	CASE QTY	CASE WEIGHT
HPS88U3	US3	8.00	40 PC		
HPS88U5	US5	8.40			
HPS88U10B	US10B	8.40		400 PC	
HPS88U15	US15	8.40			
HPS88U15A	US15A	8.40			33 LB
HPS88U19	US19	8.40			
HPS88U26	US26	8.40			
HPS88U26D	US26D	8.40			
HPS88CR003	CR003	9.00			

Solid Brass for Solid Brass Hinges

Part Number	Finish	List Each	BOX QTY	CASE QTY	CASE WEIGHT
HPH89U3	US3	8.00	40 PC		
HPH89U5	US5	8.40			
HPH89U10B	US10B	8.40		200 PC	
HPH89U15	US15	8.40			
HPH89U15A	US15A	8.40			25 LB
HPH89U19	US19	8.40			
HPH89U26	US26	8.40			
HPH89U26D	US26D	8.40			
HPH89CR003	CR003	9.00			



Hinge Pin Stop / Zinc

 Zinc Die-Cast
Hinge Pin Stop / Hinge Mounted

Part Number	Finish	List Each	CASE QTY
ZHP70U3	US3	2.65	50 PC
ZHP70U5	US5	2.65	
ZHP70U10B	US10B	2.65	CASE QTY
ZHP70U15	US15	2.65	500 PC
ZHP70U15A	US15A	2.65	
ZHP70U26	US26	2.65	CASE WEIGHT
ZHP70U26D	US26D	2.65	34 LB



Extended Button Tip / Solid Brass

For Solid Brass Hinges

Part Number	Finish	List Each
HPSS70U3-UNL	US3-UNL	2.70
HPSS70U3	US3	2.70
HPSS70U4	US4	2.70
HPSS70U5	US5	2.70
HPSS70U10B	US10B	2.70
HPSS70U14	US14	2.70
HPSS70U15	US15	2.70
HPSS70U15A	US15A	2.70
HPSS70U19	US19	2.70
HPSS70U26	US26	2.70
HPSS70U26D	US26D	2.70
HPSS70CR003	CR003	3.00



Overhead Door Stop & Holder / Solid Brass

Surface Mounted / Residential Duty

Part Number	Finish	List Price Each	BOX QTY
DCSM10U3	US3	105.00	1 PC
DCSM10U5	US5	110.00	
DCSM10U10B	US10B	110.00	CASE QTY
DCSM10U15	US15	110.00	20 PC
DCSM10U15A	US15A	110.00	
DCSM10U19	US19	110.00	CASE WEIGHT
DCSM10U26	US26	110.00	50 LB
DCSM10U26D	US26D	110.00	
DCSM10USPW	White	110.00	
DCSM10CR003	CR003	115.00	



Accessories

24" Crash Chain With Vinyl Cover

Part Number	Finish	List Price Each
DCCV607	Zinc Plated	6.00

BOX QTY	CASE QTY	CASE WEIGHT
25 PC	100 PC	40 LB



The vinyl cover on our chain door guard protects against scratching and also keeps the chain from rattling.

12" Transom Chain / Steel

Part Number	Finish	List Price Each
TC82U3	US3	5.90
TC82U15	US15	6.50

CASE QTY	CASE WEIGHT
100 PC	40 LB



Security Pin

Part Number	Finish	List Price Each	BOX QTY
44368US4	US4	3.50	24 PC
44368US26D	US26D	3.50	

CASE QTY	CASE WEIGHT
288 PC	24 LB



The Security Pin is an added security measure that holds the door in place if its hinges have been tampered with.

Packed with hinge pin and sleeve.

Catches

	Pages
Ball Catches	6 - 2
Roller Catches	6 - 2
Strikes for Catches	6 - 3
Adjustable Ball Tension Catches	6 - 3
Magnetic Catches	6 - 3



 Custom finish plating available.

CATCHES

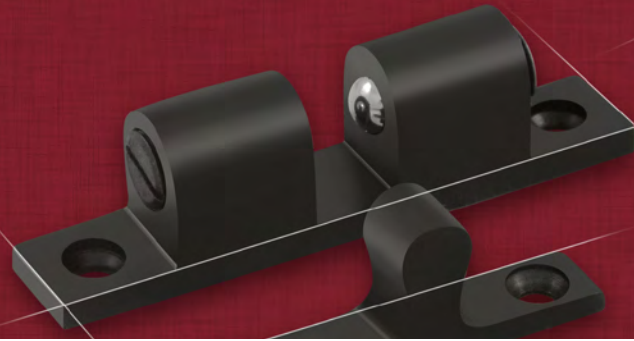

Ball Catches



Roller Catches

2 1/8" x 1" / Square Corners / Solid Brass

Part Number	Finish	List Price Each	BOX QTY	CASE QTY	CASE WEIGHT
BC218U3	US3	11.00	20 PC		
BC218U5	US5	12.80			
BC218U10B	US10B	12.80			
BC218U14	US14	12.80	200 PC		
BC218U15	US15	12.80			
BC218U15A	US15A	12.80			
BC218U19	US19	12.80			
BC218U26	US26	12.80			
BC218U26D	US26D	12.80			
BC218CR003	CR003	14.80			

2 1/4" x 7/8" / Solid Brass

Part Number	Finish	List Price Each	BOX QTY	CASE QTY	CASE WEIGHT
RCA336U3	US3	9.50	20 PC		
RCA336U5	US5	11.00			
RCA336U10B	US10B	11.00			
RCA336U15	US15	11.00			
RCA336U15A	US15A	11.00			
RCA336U19	US19	11.00			
RCA336U26	US26	11.00			
RCA336U26D	US26D	11.00			
RCA336CR003	CR003	12.50			

2 1/8" x 1" / Round Corners / Solid Brass

Part Number	Finish	List Price Each	BOX QTY	CASE QTY	CASE WEIGHT
BC218RU3	US3	11.00	20 PC		
BC218RU5	US5	12.80			
BC218RU10B	US10B	12.80			
BC218RU15	US15	12.80	200 PC		
BC218RU15A	US15A	12.80			
BC218RU19	US19	12.80			
BC218RU26	US26	12.80			
BC218RU26D	US26D	12.80			
BC218RCR003	CR003	14.80			

3 5/16" x 1" / Heavy Duty / Solid Brass

Part Number	Finish	List Price Each	BOX QTY	CASE QTY	CASE WEIGHT
RCA430U3-UNL	US3-UNL	30.00	10 PC		
RCA430U3	US3	30.00			
RCA430U5	US5	32.00	100 PC		
RCA430U10B	US10B	32.00			
RCA430U14	US14	32.00			
RCA430U15	US15	32.00			
RCA430U15A	US15A	32.00			
RCA430U19	US19	32.00			
RCA430U26	US26	32.00			
RCA430U26D	US26D	32.00			
RCA430CR003	CR003	37.00			

Drive-in / Adjustable / 1 1/8" x 1" / Steel

Part Number	List Price Each	BOX QTY	CASE QTY	CASE WEIGHT
DBC10	5.50	40 PC	200 PC	12 LB

Strike sold separately. See below.

Strike for Drive-in Ball Catch
2 1/8" x 1 3/8" / Solid Brass

Part Number	Finish	List Price Each	BOX QTY	CASE QTY	CASE WEIGHT
SPB349U3	US3	2.90	80 PC		
SPB349U5	US5	3.20			
SPB349U10B	US10B	3.20			
SPB349U15	US15	3.20	800 PC		
SPB349U15A	US15A	3.20			
SPB349U19	US19	3.20			
SPB349U26	US26	3.20			
SPB349U26D	US26D	3.20			
SPB349CR003	CR003	3.60			

1 7/8" x 1 1/2"
Surface Mounted / Steel

Part Number	Finish	List Price Each	BOX QTY	CASE QTY	CASE WEIGHT
RCS338U3	US3	3.75	50 PC		
RCS338U10B	US10B	3.90			
RCS338U15	US15	3.90	500 PC		



Strikes for Catches / Solid Brass

Adjustable Ball Tension Catches / Solid Brass

2 3/4" x 1 3/4" / Solid Brass

Part Number	Finish	List Price Each	BOX QTY 30 PC
TSRCA275U3	US3	6.40	
TSRCA275U5	US5	6.90	CASE QTY
TSRCA275U10B	US10B	6.90	300 PC
TSRCA275U15	US15	6.90	
TSRCA275U15A	US15A	6.90	
TSRCA275U26	US26	6.90	CASE WEIGHT 29 LB
TSRCA275U26D	US26D	6.90	
TSRCA275CR003	CR003	7.40	



1 7/8" x 5/16" / Solid Brass

Part Number	Finish	List Price Each	BOX QTY 80 PC
BTC10U3	US3	5.70	
BTC10U5	US5	6.90	CASE QTY
BTC10U10B	US10B	6.90	800 PC
BTC10U15	US15	6.90	
BTC10U15A	US15A	6.90	
BTC10U19	US19	6.90	CASE WEIGHT 53 LB
BTC10U26	US26	6.90	
BTC10U26D	US26D	6.90	
BTC10CR003	CR003	8.00	



4 7/8" x 1 7/8" / Solid Brass

Part Number	Finish	List Price Each	BOX QTY 20 PC
TSRCA4875U3	US3	10.20	
TSRCA4875U5	US5	11.00	CASE QTY
TSRCA4875U10B	US10B	11.00	200 PC
TSRCA4875U15	US15	11.00	
TSRCA4875U15A	US15A	11.00	
TSRCA4875U26	US26	11.00	CASE WEIGHT 27 LB
TSRCA4875U26D	US26D	11.00	
TSRCA4875CR003	CR003	11.60	



2 5/6" x 1/2" / Solid Brass

Part Number	Finish	List Price Each	BOX QTY 50 PC
BTC20U3	US3	8.20	
BTC20U5	US5	10.40	CASE QTY
BTC20U10B	US10B	10.40	500 PC
BTC20U15	US15	10.40	
BTC20U15A	US15A	10.40	CASE WEIGHT 53 LB
BTC20U19	US19	10.40	
BTC20U26	US26	10.40	
BTC20U26D	US26D	10.40	
BTC20CR003	CR003	11.70	

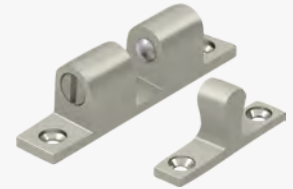

2 1/8" x 1 5/8" / Heavy Duty / Solid Brass

Part Number	Finish	List Price Each	BOX QTY 50 PC
SPRCA430U3	US3	8.80	
SPRCA430U5	US5	10.00	CASE QTY
SPRCA430U10B	US10B	10.00	250 PC
SPRCA430U15	US15	10.00	
SPRCA430U15A	US15A	10.00	
SPRCA430U19	US19	10.00	CASE WEIGHT 34 LB
SPRCA430U26	US26	10.00	
SPRCA430U26D	US26D	10.00	
SPRCA430CR003	CR003	10.50	



3" x 3/4" / Solid Brass

Part Number	Finish	List Price Each	BOX QTY 25 PC
BTC30U3	US3	17.00	
BTC30U5	US5	20.00	CASE QTY
BTC30U10B	US10B	20.00	150 PC
BTC30U15	US15	20.00	
BTC30U15A	US15A	20.00	CASE WEIGHT 63 LB
BTC30U19	US19	20.00	
BTC30U26	US26	20.00	
BTC30U26D	US26D	20.00	
BTC30CR003	CR003	22.80	



Magnetic Catches / Steel

2 1/6" x 1 3/8" x 5/8"

Part Number	List Price Each	BOX QTY 25 PC	CASE QTY 500 PC
MC325	2.30		
		CASE WEIGHT 40 LB	



3 1/8" x 1" x 3/4"

Part Number	List Price Each	BOX QTY 25 PC	CASE QTY 100 PC
MC327	6.00		
		CASE WEIGHT 20 LB	



3 1/8" x 1" x 9/16"

Part Number	List Price Each	BOX QTY 50 PC	CASE QTY 200 PC
MC326	4.40		
		CASE WEIGHT 15 LB	



Knobs, Pulls & Plates

	Pages
Door Pulls	7 - 2
Plates Pre-Drilled for Pulls	7 - 2
Plates with Pulls Installed	7 - 3
Framed Push Plates	7 - 3
Push Plates, Solid Brass	7 - 3
Push Plates, Stainless Steel	7 - 3
Offset Handle Pulls	7 - 4
Kick Plates, Stainless Steel	7 - 4
Drawer, Cabinet & Mirror Pulls	7 - 4
Flush Pulls	7 - 5
Victorian Flush Pulls	7 - 5
Window & Utility Pulls	7 - 6
Edge Pulls	7 - 7
Knobs	7 - 7
Cone Knobs	7 - 8
Shell Handle Pulls	7 - 8
Wide Pulls	7 - 8
Wire Pulls	7 - 9
Flush Ring Pulls	7 - 9
Adjustable Pulls	7 - 10
Bar Pulls 12mm Solid Stainless Steel	7 - 10
Modern Pulls, Stainless Steel	7 - 11
Modern Angle Pulls, Aluminum	7 - 12



 Custom-drilled pull plates available.

 Custom finish plating available.

KNOBS, PULLS & PLATES

Door Pulls / Solid Brass

6"

Part Number	Finish	List Price Each	BOX QTY 1 PC
DP675U3	US3	53.00	CASE QTY 50 PC
DP675U5	US5	56.00	
DP675U10B	US10B	56.00	
DP675U15	US15	56.00	
DP675U15A	US15A	56.00	
DP675U19	US19	56.00	
DP675U26	US26	56.00	
DP675U26D	US26D	56.00	
DP675CR003	CR003	60.00	

8"

Part Number	Finish	List Price Each	BOX QTY 1 PC
DP2574U3	US3	68.00	CASE QTY 25 PC
DP2574U5	US5	70.00	
DP2574U10B	US10B	70.00	
DP2574U15	US15	70.00	
DP2574U15A	US15A	70.00	
DP2574U26	US26	70.00	
DP2574CR003	CR003	82.00	



Back-to-back option available.

10"

Part Number	Finish	List Price Each	BOX QTY 1 PC
DP2575U3	US3	85.00	CASE QTY 25 PC
DP2575U5	US5	87.00	
DP2575U10B	US10B	87.00	
DP2575U15	US15	87.00	
DP2575U15A	US15A	87.00	
DP2575U26	US26	87.00	
DP2575CR003	CR003	94.00	



Back-to-back option available.

8" / With Rosettes

Part Number	Finish	List Price Each	CASE QTY 1 PC
DP2576U10B	US10B	78.00	CASE QTY 25 PC
DP2576U15	US15	78.00	
DP2576U15A	US15A	78.00	
DP2576U26	US26	78.00	CASE QTY 25 PC
DP2576CR003	CR003	90.00	



Back-to-back option available.

10" / With Rosettes

Part Number	Finish	List Price Each	BOX QTY 1 PC
DP2578U10B	US10B	94.00	CASE QTY 25 PC
DP2578U15	US15	94.00	
DP2578U15A	US15A	94.00	
DP2578U26	US26	94.00	
DP2578CR003	CR003	104.00	

Back-to-back option available.



Plates Pre-Drilled for Pulls / Solid Brass

3 1/2" x 15" / For 8" Pulls

Part Number	Finish	List Price Each	BOX QTY 10 PC
PPH3515U3	US3	32.00	CASE QTY 50 PC
PPH3515U5	US5	32.00	
PPH3515U10B	US10B	32.00	
PPH3515U15	US15	32.00	CASE WEIGHT 43 LB
PPH3515U15A	US15A	32.00	
PPH3515U26	US26	32.00	PLATE GAUGE 1.2 mm
PPH3515CR003	CR003	37.00	

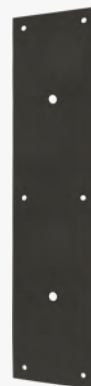
3 1/2" x 20" / For 10" Pulls

Part Number	Finish	List Price Each	BOX QTY 5 PC
PPH3520U3	US3	41.00	CASE QTY 25 PC
PPH3520U5	US5	41.00	
PPH3520U10B	US10B	41.00	
PPH3520U15	US15	41.00	CASE WEIGHT 21 LB
PPH3520U15A	US15A	41.00	
PPH3520U26	US26	41.00	PLATE GAUGE 1.2 mm
PPH3520CR003	CR003	46.00	



Plates with Pulls Installed

Framed Push Plates / Solid Brass

3 1/2"x 15" / 5 1/4" Handle / Solid Brass

Part Number	Finish	List Price Each	BOX QTY
PPH55U3	US3	56.00	5 PC
PPH55U5	US5	59.00	CASE QTY
PPH55U10B	US10B	59.00	25 PC
PPH55U15	US15	59.00	CASE WEIGHT
PPH55U15A	US15A	59.00	21 LB
PPH55U26	US26	59.00	PLATE GAUGE
PPH55U26D	US26D	59.00	1.2 mm
PPH55CR003	CR003	65.00	

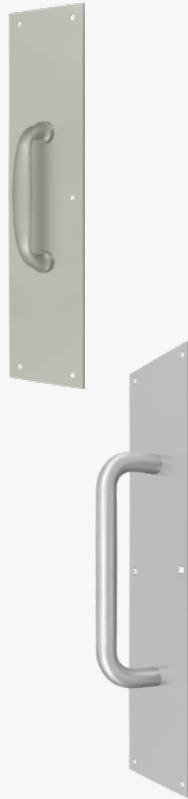

4"x 16" / 7 7/8" Handle / Stainless Steel

Part Number	Finish	List Price Each	BOX QTY
PPH4016U32D	US32D	54.00	5 PC
			CASE QTY
			25 PC
			CASE WEIGHT
			21 LB
			PLATE GAUGE
			1.2 mm

Pull Plates cannot be disassembled, pulls and plates are a single piece.

3 1/2"x 15" / Heavy Duty

Part Number	Finish	List Price Each	BOX QTY
PP2280U5	US5	90.00	1 PC
PP2280U10B	US10B	90.00	CASE QTY
PP2280U15	US15	90.00	20 PC
PP2280U15A	US15A	90.00	CASE WEIGHT
PP2280U26	US26	90.00	40 LB
PP2280CR003	CR003	106.00	PLATE GAUGE
			1.2 mm

Custom drilled holes to attach pulls are available upon request.



3 1/2"x 20" / Heavy Duty

Part Number	Finish	List Price Each	BOX QTY
PP2281U10B	US10B	118.00	1 PC
PP2281U15	US15	118.00	CASE QTY
PP2281U15A	US15A	118.00	10 PC
PP2281U26	US26	118.00	CASE WEIGHT
PP2281CR003	CR003	125.00	28 LB
			PLATE GAUGE
			1.2 mm

Custom drilled holes to attach pulls are available upon request.

Push Plates / Solid Brass

Push Plates / Stainless Steel

3 1/2"x 15"

Part Number	Finish	List Price Each	BOX QTY
PP3515U3	US3	31.00	10 PC
PP3515U5	US5	34.00	CASE QTY
PP3515U10B	US10B	34.00	50 PC
PP3515U15	US15	34.00	CASE WEIGHT
PP3515U15A	US15A	34.00	21 LB
PP3515U19	US19	34.00	PLATE GAUGE
PP3515U26	US26	34.00	1.2 mm
PP3515U26D	US26D	34.00	
PP3515CR003	CR003	39.00	

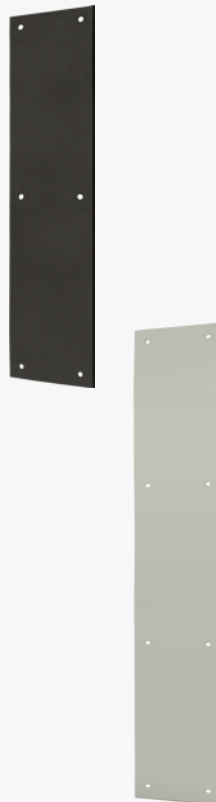

Push Plates / Stainless Steel / US32D

Part Number	Size	List Price Each	Case Qty.	PLATE GAUGE
PP3515U32D	3 1/2"x 15"	30.00	60 PC	1.10 mm
PP3520U32D	3 1/2"x 20"	38.00	40 PC	
PP4016U32D	4"x 16"	40.00	20 PC	

3 1/2"x 20"

Part Number	Finish	List Price Each	BOX QTY
PP3520U3	US3	41.00	5 PC
PP3520U5	US5	44.00	CASE QTY
PP3520U10B	US10B	44.00	25 PC
PP3520U15	US15	44.00	CASE WEIGHT
PP3520U15A	US15A	44.00	21 LB
PP3520U19	US19	44.00	PLATE GAUGE
PP3520U26	US26	44.00	1.2 mm
PP3520U26D	US26D	44.00	
PP3520CR003	CR003	51.00	

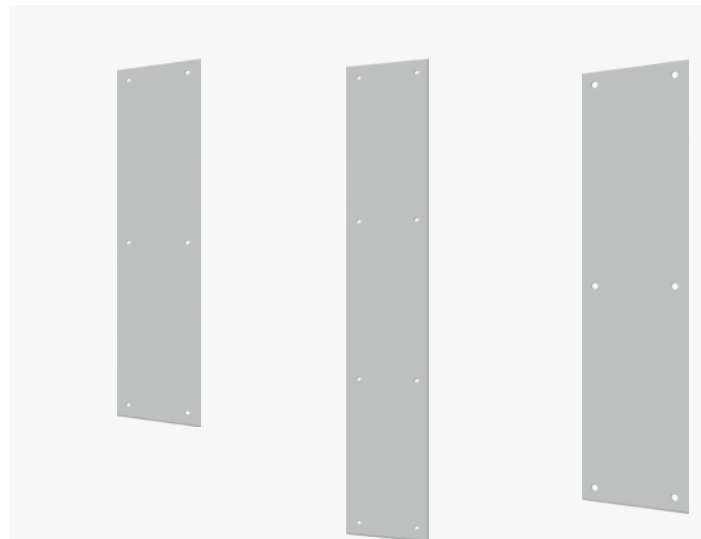

Offset Handle Pull / Solid Brass

6 1/8" / Back-to-Back Assembly

Part Number	Finish	List Price Each	CASE QTY
OHP620U3	US3	53.50	25 PC
OHP620U5	US5	57.00	
OHP620U10B	US10B	57.00	CASE WEIGHT
OHP620U15	US15	57.00	21 LB
OHP620U15A	US15A	57.00	DOORS
OHP620U19	US19	57.00	1 1/8"
OHP620U26	US26	57.00	1 3/8"
OHP620U26D	US26D	57.00	
OHP620CR003	CR003	62.00	

Back-to-back mounting hardware included.
Compatible Door Thickness: 1 1/8" ~ 1 3/8"



Kick Plates / Stainless Steel

Kick Plates / Stainless Steel / US32D

Part Number	Size	List Price Each	Case Qty.	PLATE GAUGE
KP634U32D	6"x 34"	45.00	10 PC	1.10 mm
KP834U32D	8"x 34"	57.00	10 PC	
KP1034U32D	10"x 34"	64.00	10 PC	

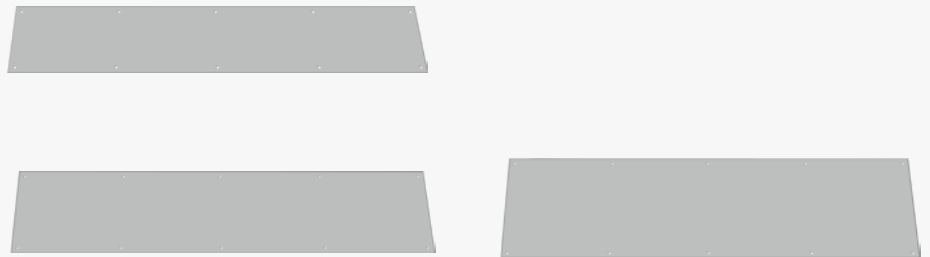

Drawer / Cabinet / Mirror Pulls / Solid Brass

1"x 1 1/2"

Part Number	Finish	List Each	BOX QTY
DCM115U3	US3	3.80	60 PC
DCM115U5	US5	4.95	
DCM115U10B	US10B	4.95	CASE QTY
DCM115U14	US14	4.95	600 PC
DCM115U15	US15	4.95	
DCM115U15A	US15A	4.95	
DCM115U19	US19	4.95	
DCM115U26	US26	4.95	
DCM115U26D	US26D	4.95	
DCM115CR003	CR003	5.50	



3"x 1 1/2"

Part Number	Finish	List Each	BOX QTY
DCM315U3	US3	8.20	45 PC
DCM315U5	US5	9.50	
DCM315U10B	US10B	9.50	CASE QTY
DCM315U14	US14	9.50	450 PC
DCM315U15	US15	9.50	
DCM315U15A	US15A	9.50	
DCM315U19	US19	9.50	
DCM315U26	US26	9.50	
DCM315U26D	US26D	9.50	
DCM315CR003	CR003	10.00	



2"x 1 1/2"

Part Number	Finish	List Each	BOX QTY
DCM215U3	US3	6.00	50 PC
DCM215U5	US5	7.50	
DCM215U10B	US10B	7.50	CASE QTY
DCM215U14	US14	7.50	500 PC
DCM215U15	US15	7.50	
DCM215U15A	US15A	7.50	
DCM215U19	US19	7.50	
DCM215U26	US26	7.50	
DCM215U26D	US26D	7.50	
DCM215CR003	CR003	8.30	

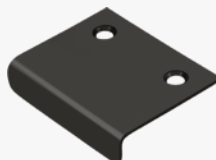

Flush Pulls

7" x 1 7/8" x 3/8" / Solid Brass

Part Number	Finish	List Each	BOX QTY
FP7178U3	US3	30.00	5 PC
FP7178U3-UNL	US3-UNL	30.00	
FP7178U4	US4	32.00	CASE QTY
FP7178U5	US5	32.00	90 PC
FP7178U10B	US10B	32.00	
FP7178U14	US14	32.00	CASE WEIGHT
FP7178U15	US15	32.00	47 LB
FP7178U15A	US15A	32.00	
FP7178U19	US19	32.00	
FP7178U26	US26	32.00	
FP7178U26D	US26D	32.00	
FP7178CR003	CR003	35.00	

3 7/8" x 1 5/8" x 3/8" / Solid Brass

Part Number	Finish	List Price Each	BOX QTY
FP4134U3	US3	19.00	20 PC
FP4134U3-UNL	US3-UNL	19.00	
FP4134U4	US4	20.00	CASE QTY
FP4134U5	US5	20.00	200 LB
FP4134U10B	US10B	20.00	
FP4134U14	US14	20.00	CASE WEIGHT
FP4134U15	US15	20.00	30 LB
FP4134U15A	US15A	20.00	
FP4134U19	US19	20.00	
FP4134U26	US26	20.00	
FP4134U26D	US26D	20.00	
FP4134CR003	CR003	22.00	

3 1/8" x 1 3/8" x 1/2" / Solid Brass

Part Number	Finish	List Price Each	BOX QTY
FP222U3-UNL	US3-UNL	12.00	20 PC
FP222U3	US3	12.00	
FP222U5	US5	13.20	CASE QTY
FP222U10B	US10B	13.20	200 PC
FP222U14	US14	13.20	CASE WEIGHT
FP222U15	US15	13.20	30 LB
FP222U15A	US15A	13.20	
FP222U19	US19	13.20	
FP222U26	US26	13.20	
FP222U26D	US26D	13.20	
FP222CR003	CR003	15.80	

7" x 1 7/8" x 3/4" / Victorian / Solid Brass

Part Number	Finish	List Price Each	BOX QTY
FPV7178U5	US5	49.00	5 PC
FPV7178U10B	US10B	49.00	
FPV7178U15	US15	49.00	CASE QTY
FPV7178U15A	US15A	49.00	75 PC
			CASE WEIGHT
			53 LB

10" x 2 1/4" x 3/4" / Solid Brass

Part Number	Finish	List Each	BOX QTY
FP10225U3	US3	52.00	5 PC
FP10225U3-UNL	US3-UNL	52.00	
FP10225U4	US4	58.00	CASE QTY
FP10225U5	US5	58.00	50 PC
FP10225U10B	US10B	58.00	
FP10225U14	US14	58.00	CASE WEIGHT
FP10225U15	US15	58.00	54 LB
FP10225U15A	US15A	58.00	
FP10225U19	US19	58.00	
FP10225U26	US26	58.00	
FP10225U26D	US26D	58.00	
FP10225CR003	CR003	64.00	

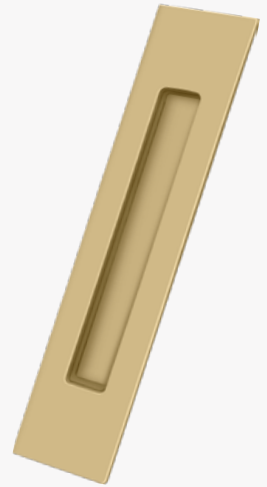
4" x 2" x 1/2" / Stainless Steel

Part Number	Finish	List Price Each	BOX QTY
FP155U32D	US32D	21.00	10 PC
			CASE QTY
			100 PC
			CASE WEIGHT
			15 LB

3 5/8" x 1 3/4" x 1/2" / Solid Brass

Part Number	Finish	List Price Each	BOX QTY
FP227U3	US3	9.20	20 PC
FP227U5	US5	9.80	
FP227U10B	US10B	9.80	CASE QTY
FP227U15	US15	9.80	200 PC
FP227U15A	US15A	9.80	
FP227U19	US19	9.80	CASE WEIGHT
FP227U26	US26	9.80	30 LB
FP227U26D	US26D	9.80	
FP227CR003	CR003	11.00	

10" x 2 1/4" x 3/4" / Victorian / Solid Brass

Part Number	Finish	List Price Each	BOX QTY
FPV10225U5	US5	78.00	5 PC
FPV10225U10B	US10B	78.00	
FPV10225U15	US15	78.00	CASE QTY
FPV10225U15A	US15A	78.00	50 PC
			CASE WEIGHT
			57 LB



Flush Pulls / Solid Brass

Round HD / 2 3/8" Diameter / Solid Brass

Part Number	Finish	List Each	BOX QTY
FP238U3	US3	11.00	50 PC
FP238U3-UNL	US3-UNL	11.00	
FP238U4	US4	12.00	CASE QTY
FP238U5	US5	12.00	150 PC
FP238U10B	US10B	12.00	
FP238U14	US14	12.00	CASE WEIGHT
FP238U15	US15	12.00	36 LB
FP238U15A	US15A	12.00	
FP238U19	US19	12.00	
FP238U26	US26	12.00	
FP238U26D	US26D	12.00	
FP238CR003	CR003	14.00	

Round HD / 1 7/8" Diameter / Solid Brass

Part Number	Finish	List Each	BOX QTY
FP178U3	US3	9.00	50 PC
FP178U3-UNL	US3-UNL	9.00	
FP178U4	US4	10.00	CASE QTY
FP178U5	US5	10.00	300 PC
FP178U10B	US10B	10.00	
FP178U14	US14	10.00	CASE WEIGHT
FP178U15	US15	10.00	40 LB
FP178U15A	US15A	10.00	
FP178U19	US19	10.00	
FP178U26	US26	10.00	
FP178U26D	US26D	10.00	
FP178CR003	CR003	12.00	

2 1/8" Diameter / Solid Brass

Part Number	Finish	List Each	BOX QTY
FP221RU3	US3	3.20	50 PC
FP221RU5	US5	3.50	
FP221RU10B	US10B	3.50	CASE QTY
FP221RU15	US15	3.50	500 PC
FP221RU15A	US15A	3.50	
FP221RU19	US19	3.50	CASE WEIGHT
FP221RU26	US26	3.50	21 LB
FP221RU26D	US26D	3.50	
FP221RCR003	CR003	4.30	

Square HD
2 3/4" x 2 3/4" x 1/2" / Solid Brass

Part Number	Finish	List Each	BOX QTY
FPS234U3	US3	24.00	25 PC
FPS234U3-UNL	US3-UNL	24.00	
FPS234U4	US4	26.00	CASE QTY
FPS234U5	US5	26.00	100 PC
FPS234U10B	US10B	26.00	
FPS234U15	US15	26.00	
FPS234U15A	US15A	26.00	
FPS234U19	US19	26.00	
FPS234U26	US26	26.00	
FPS234U26D	US26D	26.00	
FPS234CR003	CR003	28.00	

3 1/2" x 1 1/4" x 3/8" / Solid Brass

Part Number	Finish	List Each	BOX QTY
FP223U3	US3	5.00	40 PC
FP223U5	US5	5.70	
FP223U10B	US10B	5.70	CASE QTY
FP223U15	US15	5.70	400 PC
FP223U15A	US15A	5.70	
FP223U19	US19	5.70	CASE WEIGHT
FP223U26	US26	5.70	21 LB
FP223U26D	US26D	5.70	
FP223CR003	CR003	6.40	

4" x 1" x 1/2" / Solid Brass

Part Number	Finish	List Each	BOX QTY
FP828U3	US3	4.80	50 PC
FP828U5	US5	5.20	
FP828U10B	US10B	5.20	CASE QTY
FP828U15	US15	5.20	500 PC
FP828U15A	US15A	5.20	
FP828U19	US19	5.20	CASE WEIGHT
FP828U26	US26	5.20	21 LB
FP828U26D	US26D	5.20	
FP828CR003	CR003	5.90	



Window / Utility Pulls / Solid Brass

6" Overall

Part Number	Finish	List Price Each	BOX QTY
WP27U3	U3	27.80	5 PC
WP27U5	US5	29.00	
WP27U10B	US10B	29.00	CASE QTY
WP27U15	US15	29.00	50 PC
WP27U15A	US15A	29.00	
WP27U19	US19	29.00	
WP27U26	US26	29.00	
WP27U26D	US26D	29.00	
WP27CR003	CR003	32.00	

4" Overall

Part Number	Finish	List Price Each	BOX QTY
WP026U3-UNL	US3-UNL	8.00	10 PC
WP026U3	US3	8.00	
WP026U5	US5	8.50	CASE QTY
WP026U10B	US10B	8.50	200 PC
WP026U14	US14	8.50	
WP026U15	US15	8.50	
WP026U15A	US15A	8.50	
WP026U19	US19	8.50	
WP026U26	US26	8.50	
WP026U26D	US26D	8.50	



Edge Pulls / Solid Brass

4"x 3/4"

Part Number	Finish	List Price Each	BOX QTY
EP475U3	US3	10.00	20 PC
EP475U3-UNL	US3-UNL	10.00	
EP475U4	US4	11.00	
EP475U5	US5	11.00	
EP475U10B	US10B	11.00	
EP475U14	US14	11.00	
EP475U15	US15	11.00	
EP475U15A	US15A	11.00	
EP475U19	US19	11.00	
EP475U26	US26	11.00	
EP475U26D	US26D	11.00	
EP475CR003	CR003	13.00	



6 1/4"x 1 1/4"

Part Number	Finish	List Price Each	BOX QTY
EP6125U3	U3	28.80	5 PC
EP6125U4	US4	29.50	
EP6125U5	US5	29.50	
EP6125U10B	US10B	29.50	
EP6125U14	US14	29.50	
EP6125U15	US15	29.50	
EP6125U15A	US15A	29.50	
EP6125U19	US19	29.50	
EP6125U26	US26	29.50	
EP6125U26D	US26D	29.50	
EP6125CR003	CR003	32.50	



4 1/2"x 1"x 3/8" / Thin

Part Number	Finish	List Price Each	BOX QTY
EPT425U3	U3	16.70	20 PC
EPT425U5	US5	19.00	
EPT425U10B	US10B	19.00	
EPT425U15	US15	19.00	
EPT425U15A	US15A	19.00	
EPT425U26	US26	19.00	
EPT425U26D	US26D	19.00	
EPT425CR003	CR003	20.50	



1 1/4" Diameter

Part Number	Finish	List Price Each	BOX QTY
BPRK125U3	US3	2.20	100 PC
BPRK125U5	US5	2.80	
BPRK125U10B	US10B	2.80	
BPRK125U15	US15	2.80	
BPRK125U15A	US15A	2.80	
BPRK125U26	US26	2.80	
BPRK125U26D	US26D	2.80	
BPRK125CR003	CR003	3.00	



1" Diameter

Part Number	Finish	List Price Each	BOX QTY
BPRC100U3	US3	4.20	100 PC
BPRC100U5	US5	4.50	
BPRC100U10B	US10B	4.50	
BPRC100U15	US15	4.50	
BPRC100U15A	US15A	4.50	
BPRC100U26	US26	4.50	
BPRC100U26D	US26D	4.50	
BPRC100CR003	CR003	5.30	



1 1/2" Diameter

Part Number	Finish	List Price Each	BOX QTY
BPRC150U3	US3	5.00	50 PC
BPRC150U5	US5	5.50	
BPRC150U10B	US10B	5.50	
BPRC150U15	US15	5.50	
BPRC150U15A	US15A	5.50	
BPRC150U26	US26	5.50	
BPRC150U26D	US26D	5.50	
BPRC150CR003	CR003	6.10	



Knobs / Solid Brass

1 1/4" / Solid Round knob

Part Number	Finish	List Each	BOX QTY
KR114U3	US3	9.00	10 PC
KR114U5	US5	10.00	
KR114U10B	US10B	10.00	
KR114U14	US14	10.00	
KR114U15	US15	10.00	
KR114U15A	US15A	10.00	
KR114U19	US19	10.00	
KR114U26	US26	10.00	
KR114U26D	US26D	10.00	
KR114CR003	CR003	10.80	



1 1/4" / Hollow Round Knob

Part Number	Finish	List Each	BOX QTY
KRH114U3	US3	6.20	20 PC
KRH114U5	US5	6.90	
KRH114U10B	US10B	6.90	
KRH114U15	US15	6.90	
KRH114U15A	US15A	6.90	
KRH114U26	US26	6.90	
KRH114U26D	US26D	6.90	

1 1/4" Diameter / Oval

Part Number	Finish	List Price Each	BOX QTY
KE125U3	US3	9.00	20 PC
KE125U5	US5	10.00	
KE125U10B	US10B	10.00	
KE125U15	US15	10.00	
KE125U15A	US15A	10.00	
KE125U26	US26	10.00	
KE125U26D	US26D	10.00	
KE125CR003	CR003	10.80	

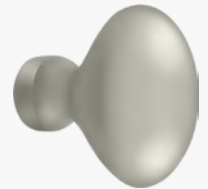

Knobs / Solid Brass

1 3/4" Diameter / Round / Heavy Duty / w/Groove

Part Number	Finish	List Price Each	BOX QTY
KRB175U3	US3	16.50	10 PC
KRB175U5	US5	18.50	
KRB175U10B	US10B	18.50	
KRB175U15	US15	18.50	CASE QTY 200 PC
KRB175U15A	US15A	18.50	
KRB175U19	US19	18.50	
KRB175U26	US26	18.50	
KRB175U26D	US26D	18.50	
KRB175CR003	CR003	22.00	



1 1/4" Diameter / Round / w/ Groove

Part Number	Finish	List Price Each	BOX QTY
KR119U3	US3	11.00	10 PC
KR119U5	US5	11.80	
KR119U10B	US10B	11.80	
KR119U15	US15	11.80	CASE QTY 200 PC
KR119U15A	US15A	11.80	
KR119U19	US19	11.80	
KR119U26	US26	11.80	
KR119U26D	US26D	11.80	
KR119CR003	CR003	13.00	



Cone Knobs / Solid Brass

3/8" Base / 3/4" Diameter

Part Number	Finish	List Price Each	BOX QTY
KC20U3	US3	6.20	25 PC
KC20U5	US5	6.50	
KC20U10B	US10B	6.50	CASE QTY 250 PC
KC20U15	US15	6.50	
KC20U15A	US15A	6.50	
KC20U19	US19	6.50	PROJECTS 1"
KC20U26	US26	6.50	
KC20U26D	US26D	6.50	
KC20CR003	CR003	8.50	
KC20U32D	US32D	8.50	



SS

1/2" Base / 7/8" Diameter

Part Number	Finish	List Price Each	BOX QTY
KC24U3	US3	7.80	20 PC
KC24U5	US5	8.80	
KC24U10B	US10B	8.80	CASE QTY 250 PC
KC24U15	US15	8.80	
KC24U15A	US15A	8.80	
KC24U19	US19	8.80	PROJECTS 1 1/8"
KC24U26	US26	8.80	
KC24U26D	US26D	8.80	
KC24CR003	CR003	11.00	
KC24 U32D	US32D	11.00	

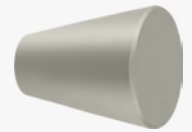

SS

Stainless Steel

Shell Handle Pulls / Solid Brass

3 1/2"

Part Number	Finish	List Price Each	BOX QTY
K43U3	US3	17.10	10 PC
K43U5	US5	18.00	
K43U10B	US10B	18.00	CASE QTY 100 PC
K43U15	US15	18.00	
K43U15A	US15A	18.00	
K43U19	US19	18.00	
K43U26	US26	18.00	
K43U26D	US26D	18.00	
K43CR003	CR003	19.50	



4 1/2"

Part Number	Finish	List Price Each	BOX QTY
K407U3	US3	19.10	10 PC
K407U5	US5	20.00	
K407U10B	US10B	20.00	CASE QTY 100 PC
K407U15	US15	20.00	
K407U15A	US15A	20.00	
K407U19	US19	20.00	
K407U26	US26	20.00	
K407U26D	US26D	20.00	
K407CR003	CR003	21.50	



4"

Part Number	Finish	List Price Each	BOX QTY
SHP29U3	US3	10.00	30 PC
SHP29U5	US5	11.80	
SHP29U10B	US10B	11.80	CASE QTY 300 PC
SHP29U15	US15	11.80	
SHP29U15A	US15A	11.80	
SHP29U19	US19	11.80	
SHP29U26	US26	11.80	
SHP29U26D	US26D	11.80	
SHP29CR003	CR003	13.00	



Flush Ring Pulls / Solid Brass

3" / Wide Pull

Part Number	Finish	List Price Each	BOX QTY
K136U3	US3	9.90	15 PC
K136U5	US5	11.00	CASE QTY 150 PC
K136U10B	US10B	11.00	
K136U15	US15	11.00	
K136U15A	US15A	11.00	
K136U19	US19	11.00	
K136U26	US26	11.00	
K136U26D	US26D	11.00	
K136CR003	CR003	12.40	



Wire Pulls / Solid Brass

3" / Wire Pull

Part Number	Finish	List Price Each	BOX QTY 20 PC
PW300U3	US3	6.30	CASE QTY 200 PC
PW300U5	US5	6.80	
PW300U10B	US10B	6.80	
PW300U15	US15	6.80	
PW300U15A	US15A	6.80	
PW300U19	US19	6.80	
PW300U26	US26	6.80	
PW300U26D	US26D	6.80	
PW300CR003	CR003	7.20	



3 1/2" / Wire Pull

Part Number	Finish	List Price Each	BOX QTY 20 PC
PW350U3	US3	7.10	CASE QTY 200 PC
PW350U5	US5	7.70	
PW350U10B	US10B	7.70	
PW350U15	US15	7.70	
PW350U15A	US15A	7.70	
PW350U19	US19	7.70	
PW350U26	US26	7.70	
PW350U26D	US26D	7.70	
PW350CR003	CR003	8.00	



4" / Wire Pull

Part Number	Finish	List Price Each	BOX QTY 20 PC
PW400U3	US3	8.00	CASE QTY 200 PC
PW400U5	US5	8.80	
PW400U10B	US10B	8.80	
PW400U15	US15	8.80	
PW400U15A	US15A	8.80	
PW400U19	US19	8.80	
PW400U26	US26	8.80	
PW400U26D	US26D	8.80	
PW400CR003	CR003	9.20	



3" / Colonial Wire Pull

Part Number	Finish	List Price Each	BOX QTY 20 PC
K4473U3	US3	7.50	CASE QTY 200 PC
K4473U5	US5	8.00	
K4473U10B	US10B	8.00	
K4473U15	US15	8.00	
K4473U15A	US15A	8.00	
K4473U19	US19	8.00	
K4473U26	US26	8.00	
K4473U26D	US26D	8.00	
K4473CR003	CR003	9.10	



4" / Colonial Wire Pull

Part Number	Finish	List Price Each	BOX QTY 20 PC
K4474U3	US3	8.50	CASE QTY 200 PC
K4474U5	US5	9.00	
K4474U10B	US10B	9.00	
K4474U15	US15	9.00	
K4474U15A	US15A	9.00	
K4474U19	US19	9.00	
K4474U26	US26	9.00	
K4474U26D	US26D	9.00	
K4474CR003	CR003	10.10	



3" / Traditional Wire Pull

Part Number	Finish	List Price Each	BOX QTY 20 PC
PCT300U3	US3	5.50	CASE QTY 200 PC
PCT300U5	US5	6.00	
PCT300U10B	US10B	6.00	
PCT300U15	US15	6.00	
PCT300U15A	US15A	6.00	
PCT300U19	US19	6.00	
PCT300U26	US26	6.00	
PCT300U26D	US26D	6.00	
PCT300CR003	CR003	7.00	



3 1/2" / Traditional Wire Pull

Part Number	Finish	List Price Each	BOX QTY 20 PC
PCT350U3	US3	6.40	CASE QTY 200 PC
PCT350U5	US5	7.00	
PCT350U10B	US10B	7.00	
PCT350U15	US15	7.00	
PCT350U15A	US15A	7.00	
PCT350U19	US19	7.00	
PCT350U26	US26	7.00	
PCT350U26D	US26D	7.00	
PCT350CR003	CR003	8.00	



4" / Traditional Wire Pull

Part Number	Finish	List Price Each	BOX QTY 20 PC
PCT400U3	US3	7.10	CASE QTY 200 PC
PCT400U5	US5	7.80	
PCT400U10B	US10B	7.80	
PCT400U15	US15	7.80	
PCT400U15A	US15A	7.80	
PCT400U19	US19	7.80	
PCT400U26	US26	7.80	
PCT400U26D	US26D	7.80	
PCT400CR003	CR003	8.90	



Flush Ring Pulls / Solid Brass

2 1/2"x 1 7/8"

Part Number	Finish	List Price Each	BOX QTY 20 PC
FRP25U3	US3	16.20	CASE QTY 200 PC
FRP25U5	US5	20.00	
FRP25U10B	US10B	20.00	
FRP25U15	US15	20.00	
FRP25U15A	US15A	20.00	
FRP25U19	US19	20.00	
FRP25U26	US26	20.00	
FRP25U26D	US26D	20.00	
FRP25CR003	CR003	22.60	



1 3/4"x 1 3/8"

Part Number	Finish	List Price Each	BOX QTY 50 PC
FRP175U3	US3	10.20	CASE QTY 500 PC
FRP175U5	US5	12.40	
FRP175U10B	US10B	12.40	
FRP175U15	US15	12.40	
FRP175U15A	US15A	12.40	
FRP175U19	US19	12.40	
FRP175U26	US26	12.40	
FRP175U26D	US26D	12.40	
FRP175CR003	CR003	15.00	



Adjustable Pulls / Solid Brass

4 3/4"

Part Number	Finish	List Price Each	BOX QTY
P310U3	US3	13.00	25 PC
P310U5	US5	14.20	
P310U10B	US10B	14.20	CASE QTY
P310U15	US15	14.20	250 PC
P310U15A	US15A	14.20	
P310U19	US19	14.20	
P310U26	US26	14.20	
P310U26D	US26D	14.20	
P310CR003	CR003	16.00	

Adjustable out to 4 1/4" center-to-center.



6 1/2"

Part Number	Finish	List Price Each	BOX QTY
P311U3	US3	14.40	25 PC
P311U5	US5	16.80	
P311U10B	US10B	16.80	CASE QTY
P311U15	US15	16.80	250 PC
P311U15A	US15A	16.80	
P311U19	US19	16.80	
P311U26	US26	16.80	
P311U26D	US26D	16.80	
P311CR003	CR003	19.30	

Adjustable to 6" center-to-center.



Instructions to adjust width of pull during installation and avoid scratching.

1. Unscrew the legs completely.
2. Remove set screw to loosen round ring/clamp.
3. Adjust ring/clamp to required width position.
4. Replace and tighten set screw.
5. Reattach legs.



Bar Pulls / 12mm Diameter / Solid Core Stainless Steel

Part Number	Center-Center	Length	Case Qty	List Price Each
BP3000SS	3"	5 1/4"	100 PC	8.50
BP3750SS	3 3/4"	6"	100 PC	9.70
BP3500SS	3 3/4"	6 1/8"	100 PC	10.00
BP5000SS	5"	7 1/4"	100 PC	10.40
BP7500SS	7 9/16"	9 3/4"	100 PC	11.60
BP1000SS	10"	13 1/4"	60 PC	13.80
BP1138SS	11 5/16"	13 5/8"	50 PC	14.50
BP1250SS	12 9/16"	15 3/4"	30 PC	15.00
BP1378SS	13 7/8"	16 1/2"	50 PC	15.80
BP1637SS	16 3/8"	19 1/2"	30 PC	18.50
BP1900SS	18 7/8"	22"	40 PC	20.00
BP1878SS	19"	21 1/2"	40 PC	19.50
BP2138SS	21 3/8"	24 5/8"	40 PC	22.00
BP2500SS	25 1/4"	28 3/8"	30 PC	23.80
BP2650SS	26 1/2"	28 7/16"	25 PC	24.80
BP2775SS	27 3/4"	31"	30 PC	28.00
BP3675SS	18 1/2" - 3 legs	40"	25 PC	36.00

Bar pulls are solid stainless steel, not hollow.

PROJECT
1 1/4"

12 mm

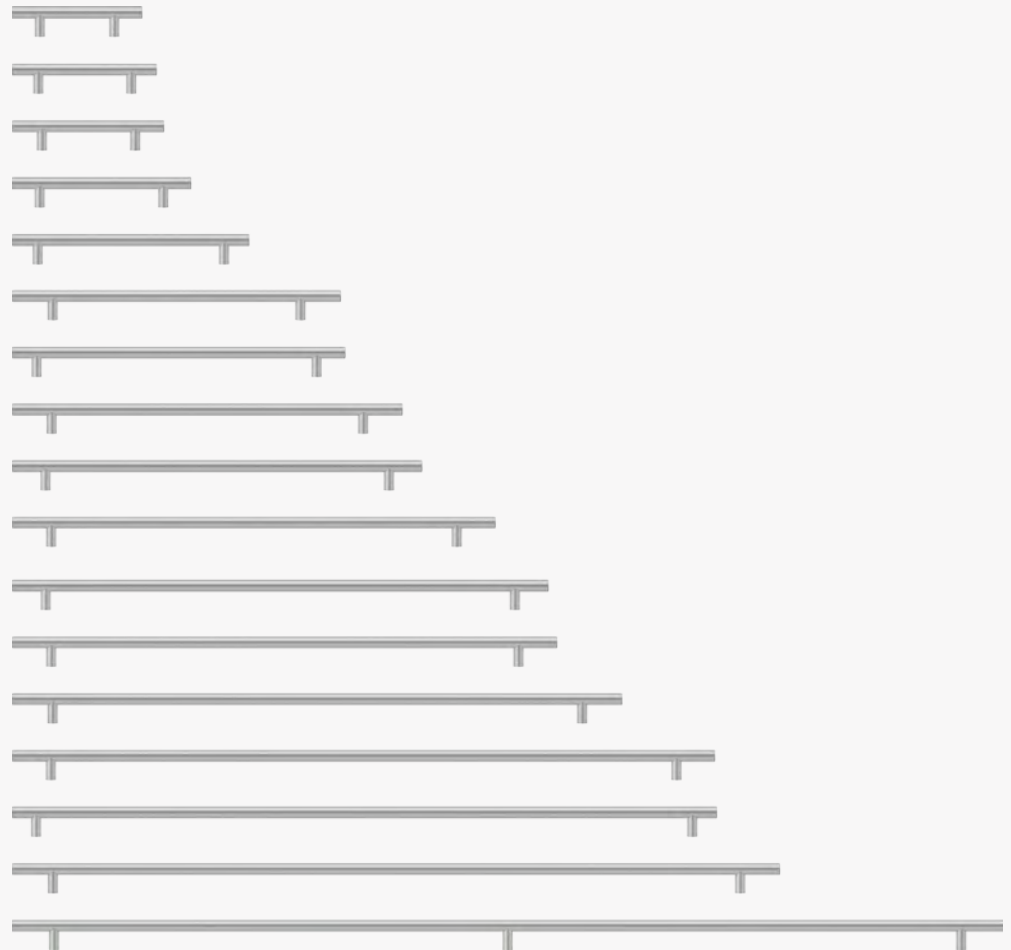

12" Long x 1" Thick / Single Side

Part Number	Finish	List Price Each	CASE QTY 10 PCS
SSP1210U19	US19	57.00	
SSP1210U32	US32	49.00	
SSP1210U32D	US32D	43.00	

12" Long x 1" Thick / Back-To-Back

Part Number	Finish	List Price Each	CASE QTY 10 PCS
SSPB1210U19	US19	91.00	
SSPB1210U32	US32	75.00	
SSPB1210U32D	US32D	64.00	

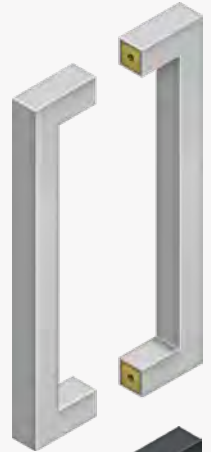
18" Long x 1" Thick / Single Side

Part Number	Finish	List Price Each	CASE QTY 10 PCS
SSP1810U19	US19	66.00	
SSP1810U32	US32	56.00	
SSP1810U32D	US32D	48.00	

18" Long x 1" Thick / Back-To-Back

Part Number	Finish	List Price Each	CASE QTY 10 PCS
SSPB1810U19	US19	105.00	
SSPB1810U32	US32	87.00	
SSPB1810U32D	US32D	74.00	

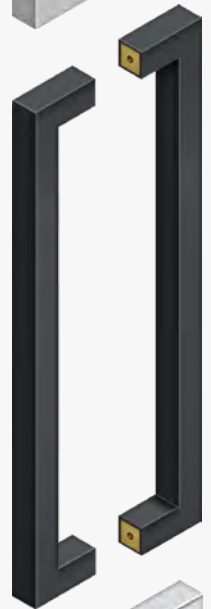
24" Long x 1" Thick / Single Side

Part Number	Finish	List Price Each	CASE QTY 10 PCS
SSP2410U19	US19	78.00	
SSP2410U32	US32	65.00	
SSP2410U32D	US32D	54.00	

24" Long x 1" Thick / Back-To-Back

Part Number	Finish	List Price Each	CASE QTY 10 PCS
SSPB2410U19	US19	122.00	
SSPB2410U32	US32	100.00	
SSPB2410U32D	US32D	86.00	

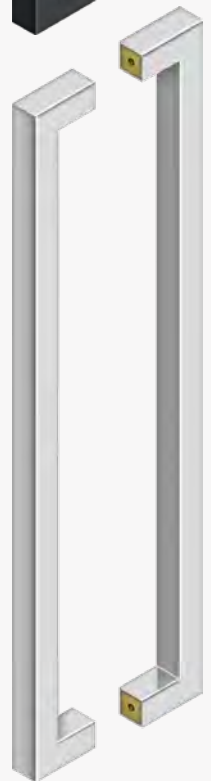

Modern Angle Pull / 2 15/16"

Part Number	Finish	List Price Each	BOX QTY
MP21516U10B	US10B	4.90	100 PC
MP21516U15	US15	4.90	CASE QTY 400 PC
MP21516U26	US26	4.90	

Modern Angle Pull / 5 7/8"

Part Number	Finish	List Price Each	BOX QTY
MP578U10B	US10B	6.40	50 PC
MP578U15	US15	6.40	CASE QTY 200 PC
MP578U26	US26	6.40	

Modern Angle Pull / 9 1/16"

Part Number	Finish	List Price Each	BOX QTY
MP9116U10B	US10B	8.80	50 PC
MP9116U15	US15	8.80	CASE QTY 200 PC
MP9116U26	US26	8.80	

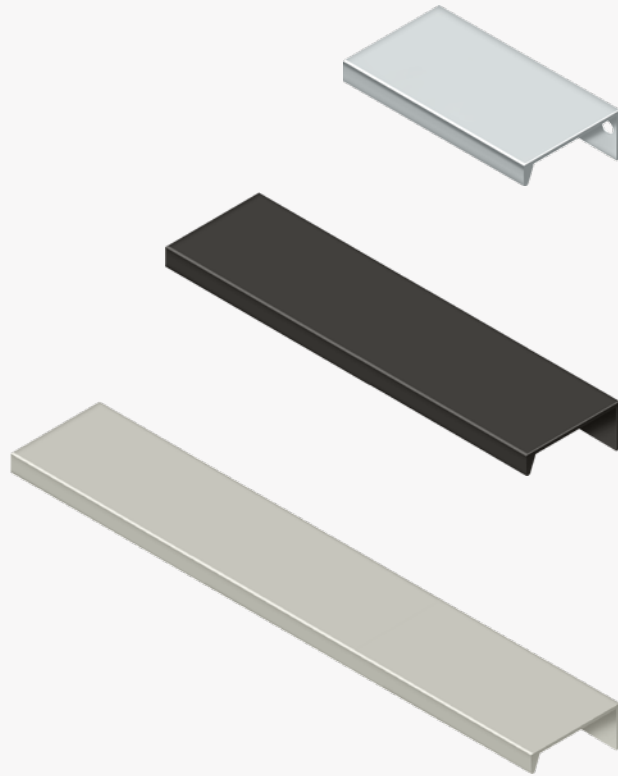

Door Accessories

	Pages
Screen / Storm Door Locks	8 - 2
Mail Slots	8 - 3
Mail Slot Accessories	8 - 3
Security Door Guards	8 - 4
Chain Door Guard	8 - 4
Bell Buttons	8 - 4
Door Knockers	8 - 5
Door Viewer	8 - 5
Pocket Lock Receiver	8 - 6
Pocket Locks	8 - 6
Pocket Door Bolt	8 - 7



 Custom finish plating available.

DOOR ACCESSORIES



Screen and Storm Door Locks & Accessories / Solid Brass

Rectangular / Mortise Lock

Part Number	Finish	List Price Each
SDML334U3	US3	110.00
SDML334U5	US5	114.00
SDML334U10B	US10B	114.00
SDML334U15	US15	114.00
SDML334U15A	US15A	114.00
SDML334U19	US19	114.00
SDML334U26	US26	114.00
SDML334U26D	US26D	114.00
SDML334CR003	CR003	118.00

BACKSET	DOOR	KNOB PROJECTS	LEVER PROJECTS
1 1/2"	7/8" ~ 2"	2"	1 1/8"
PLATES	FACE	EXTRUDED BRASS	PRIVACY FUNCTION
4 1/4" x 1 1/4"	3 3/4" x 3/4"		



*Packaged as shown. Free swap for Lever-Lever or Knob-Knob configuration upon request.

Classic / Mortise Lock / 2"x 2"x 1/2"

Part Number	Finish	List Price Each
SDL688U3	US3	104.00
SDL688U5	US5	110.00
SDL688U10B	US10B	110.00
SDL688U15	US15	110.00
SDL688U15A	US15A	110.00
SDL688U19	US19	110.00
SDL688U26	US26	110.00
SDL688U26D	US26D	110.00
SDL688CR003	CR003	120.00

BACKSET	DOOR	KNOB PROJECTS	LEVER PROJECTS
1 1/2"	7/8" ~ 2"	1 3/4"	2"
PLATES	FACE	EXTRUDED BRASS	PRIVACY FUNCTION
6" x 1 1/2"	3 1/4" x 3/4"		



*Packaged as shown. Free swap for Lever-Lever or Knob-Knob configuration upon request.

Rectangular / Tubular Lock

Part Number	Finish	List Price Each
SDLS480U3-UNL	US3-UNL	41.50
SDLS480U3	US3	41.50
SDLS480U10B	US10B	48.00
SDLS480U15	US15	48.00
SDLS480U19	US19	41.50

BACKSET	DOOR	KNOB PROJECTS	LEVER PROJECTS
1 3/4"	7/8" ~ 1 3/4"	2 1/8"	2 1/8"
PLATES	PRIVACY FUNCTION		
4" x 1 3/8"			



*Packaged as shown. Free swap for Lever-Lever or Knob-Knob configuration upon request.

Round / Tubular Lock

Part Number	Finish	List Price Each
SDL980U3-UNL	US3-UNL	36.60
SDL980U3	US3	36.60
SDL980U5	US5	37.50
SDL980U10B	US10B	37.50
SDL980U15	US15	37.50
SDL980U19	US19	36.60

BACKSET	DOOR	KNOB PROJECTS	LEVER PROJECTS
1 3/4"	7/8" ~ 1 3/8"	2 1/8"	2"
PRIVACY FUNCTION			



*Packaged as shown. Free swap for Lever-Lever or Knob-Knob configuration upon request.

*Lever and Knob Accessories also available for Stock. See page 12 - 7

Mail Slots / Solid Brass

13"x 3 1/8" / Heavy Duty

Part Number	Finish	List Price Each	BOX QTY 1 PC
MS0030U3	US3	135.00	CASE QTY 20 PC
MS0030U5	US5	135.00	
MS0030U10B	US10B	135.00	CASE WEIGHT 65 LB
MS0030U15	US15	135.00	
MS0030U15A	US15A	135.00	
MS0030U19	US19	135.00	
MS0030U26	US26	135.00	
MS0030U26D	US26D	135.00	
MS0030CR003	CR003	145.00	

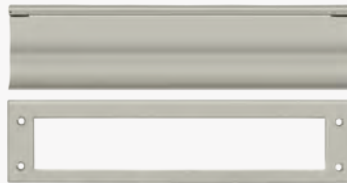

8 7/8"x 2 7/8" / Standard

Part Number	Finish	List Price Each	BOX QTY 1 PC
MS626U3	US3	55.00	CASE QTY 50 PC
MS626U5	US5	55.00	
MS626U10B	US10B	55.00	CASE WEIGHT 35 LB
MS626U15	US15	55.00	
MS626U15A	US15A	55.00	
MS626U19	US19	55.00	
MS626U26	US26	55.00	
MS626U26D	US26D	55.00	
MS626CR003	CR003	63.00	



13 1/8"x 3 5/8" / Standard

Part Number	Finish	List Price Each	BOX QTY 1 PC
MS211U3	US3	62.00	CASE QTY 25 PC
MS211U5	US5	62.00	
MS211U10B	US10B	62.00	CASE WEIGHT 29 LB
MS211U15	US15	62.00	
MS211U15A	US15A	62.00	
MS211U19	US19	62.00	
MS211U26	US26	62.00	
MS211U26D	US26D	62.00	
MS211CR003	CR003	68.00	



8 7/8"x 2 7/8" / With Interior Flap

Part Number	Finish	List Price Each	BOX QTY 1 PC
MS627U3	US3	69.00	CASE QTY 50 PC
MS627U5	US5	69.00	
MS627U10B	US10B	69.00	CASE WEIGHT 46 LB
MS627U15	US15	69.00	
MS627U15A	US15A	69.00	
MS627U19	US19	69.00	
MS627U26	US26	69.00	
MS627U26D	US26D	69.00	
MS627CR003	CR003	79.00	



13 1/8"x 3 5/8" / With Interior Flap

Part Number	Finish	List Price Each	BOX QTY 1 PC
MS212U3	US3	88.00	CASE QTY 25 PC
MS212U5	US5	88.00	
MS212U10B	US10B	88.00	CASE WEIGHT 49 LB
MS212U15	US15	88.00	
MS212U15A	US15A	88.00	
MS212U19	US19	88.00	
MS212U26	US26	88.00	
MS212U26D	US26D	88.00	
MS212CR003	CR003	96.00	



Mail Slot Accessories

 Letter Box Sleeve / Stainless Steel
For MS0030 / MS211 / MS212

Part Number	Finish	List Price Each	BOX QTY 5 PC	CASE QTY 10 PC
MSS005	US32D	25.00		

 Letter Box Hood / Solid Brass
For MS0030 / MS211

Part Number	Finish	List Price Each	BOX QTY 10 PC	CASE QTY 60 PC	CASE WEIGHT 29 LB
MSH158U3	US3	37.00			
MSH158U5	US5	40.00			
MSH158U10B	US10B	40.00			
MSH158U15	US15	40.00			
MSH158U15A	US15A	40.00			
MSH158U19	US19	40.00			
MSH158U26	US26	40.00			
MSH158U26D	US26D	40.00			
MSH158CR003	CR003	43.00			



Security Door Guards / Solid Brass

Bell Buttons / Solid Brass

**6 5/8" x 2 1/2" / Contemporary / Heavy Duty
With Ball Tension Action**

Part Number	Finish	List Price Each	BOX QTY 10 PC
DGSB675U3	US3	26.00	CASE QTY 100 PC
DGSB675U5	US5	29.00	
DGSB675U10B	US10B	29.00	CASE WEIGHT 40 LB
DGSB675U15	US15	29.00	
DGSB675U15A	US15A	29.00	
DGSB675U19	US19	29.00	
DGSB675U26	US26	29.00	
DGSB675U26D	US26D	29.00	
DGSB675CR003	CR003	32.00	

4" x 2 1/2"

Part Number	Finish	List Price Each	BOX QTY 10 PC
DG425U3	US3	26.00	CASE QTY 100 LB
DG425U5	US5	27.50	
DG425U10B	US10B	27.50	CASE WEIGHT 38 LB
DG425U15	US15	27.50	
DG425U15A	US15A	27.50	
DG425U19	US19	27.50	
DG425U26	US26	27.50	
DG425U26D	US26D	27.50	
DG425CR003	CR003	30.00	

5" x 2 1/2"

Part Number	Finish	List Price Each	BOX QTY 10 PC
DG525U3	US3	26.00	CASE QTY 100 PC
DG525U5	US5	29.00	
DG525U10B	US10B	29.00	CASE WEIGHT 40 LB
DG525U15	US15	29.00	
DG525U15A	US15A	29.00	
DG525U19	US19	29.00	
DG525U26	US26	29.00	
DG525U26D	US26D	29.00	
DG525CR003	CR003	32.00	

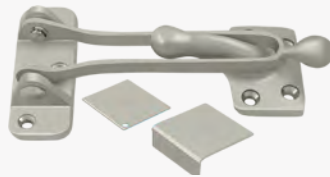
Chain Door Guard / Doorbolt

Part Number	Finish	List Price Each	BOX QTY 15 PC
CDG35U3	US3	17.00	CASE WEIGHT 27 PC
CDG35U5	US5	18.00	
CDG35U10B	US10B	18.00	
CDG35U15	US15	18.00	
CDG35U15A	US15A	18.00	
CDG35U19	US19	18.00	
CDG35U26	US26	18.00	
CDG35U26D	US26D	18.00	
CDG35CR003	CR003	20.00	

2 1/4" Diameter / Round With Rope Pattern

Part Number	Finish	List Price Each	BOX QTY 2 PC
BBRR213U3	US3	29.80	CASE QTY 60 PC
BBRR213U5	US5	32.80	
BBRR213U10B	US10B	32.80	
BBRR213U15	US15	32.80	
BBRR213U15A	US15A	32.80	
BBRR213U19	US19	32.80	
BBRR213U26	US26	32.80	
BBRR213U26D	US26D	32.80	
BBRR213CR003	CR003	34.80	

2 1/4" Diameter / Round

Part Number	Finish	List Price Each	BOX QTY 2 PC
BBR213U3	US3	29.80	CASE QTY 60 PC
BBR213U5	US5	32.80	
BBR213U10B	US10B	32.80	
BBR213U15	US15	32.80	
BBR213U15A	US15A	32.80	
BBR213U19	US19	32.80	
BBR213U26	US26	32.80	
BBR213U26D	US26D	32.80	
BBR213CR003	CR003	34.80	

2 3/8" x 1 5/8" / Oblong Plastic Button

Part Number	Finish	List Price Each	BOX QTY 25 PC
BBC20U3	US3	19.00	CASE QTY 250 PC
BBC20U5	US5	22.00	
BBC20U10B	US10B	22.00	
BBC20U15	US15	22.00	
BBC20U15A	US15A	22.00	
BBC20U19	US19	22.00	
BBC20U26	US26	22.00	
BBC20U26D	US26D	22.00	
BBC20CR003	CR003	24.00	

BBC20 Replacement Bell Button

Part Number	Finish	List Price Each
BBC20-REPLU3	US3	6.00
BBC20-REPLU5	US5	6.50
BBC20-REPLU10B	US10B	6.50
BBC20-REPLU15	US15	6.50
BBC20-REPLU15A	US15A	6.50
BBC20-REPLU19	US19	6.50
BBC20-REPLU26	US26	6.50
BBC20-REPLU26D	US26D	6.50
BBC20-REPL003	CR003	7.00



Bell Buttons / Solid Brass

3 1/4"x 1 1/4" / Rectangular

Part Number	Finish	List Price Each	BOX QTY 2 PC
BBS333U3	US3	29.80	CASE QTY 60 PC
BBS333U5	US5	32.80	
BBS333U10B	US10B	32.80	
BBS333U15	US15	32.80	
BBS333U15A	US15A	32.80	
BBS333U19	US19	32.80	
BBS333U26	US26	32.80	
BBS333U26D	US26D	32.80	
BBS333CR003	CR003	34.80	



3 1/4"x 1 1/4" / Rectangular With Rope Pattern

Part Number	Finish	List Price Each	BOX QTY 2 PC
BBSR333U3	US3	29.80	CASE QTY 60 PC
BBSR333U5	US5	32.80	
BBSR333U10B	US10B	32.80	
BBSR333U15	US15	32.80	
BBSR333U15A	US15A	32.80	
BBSR333U19	US19	32.80	
BBSR333U26	US26	32.80	
BBSR333U26D	US26D	32.80	
BBSR333CR003	CR003	34.80	



Door Knockers with Viewers / Solid Brass

8 1/2"x 4 1/8" / Imperial

Part Number	Finish	List Price Each	BOX QTY 1 PC
DK854U3	US3	62.00	CASE QTY 20 PC
DK854U5	US5	68.00	
DK854U10B	US10B	68.00	
DK854U15	US15	68.00	
DK854U15A	US15A	68.00	
DK854U19	US19	68.00	
DK854U26	US26	68.00	
DK854U26D	US26D	68.00	
DK854CR003	CR003	72.00	



7"x 3 1/2" / Victorian

Part Number	Finish	List Price Each	BOX QTY 1 PC
DK7356U3	US3	52.00	CASE QTY 50 PC
DK7356U5	US5	55.00	
DK7356U10B	US10B	55.00	
DK7356U15	US15	55.00	
DK7356U15A	US15A	55.00	
DK7356U19	US19	55.00	
DK7356U26	US26	55.00	
DK7356U26D	US26D	55.00	
DK7356CR003	CR003	60.00	



6"x 3" / Victorian Rope With Viewer

Part Number	Finish	List Price Each	BOX QTY 1 PC
DKV6RU3	US3	40.00	CASE QTY 20 PC
DKV6RU5	US5	43.00	
DKV6RU10B	US10B	43.00	
DKV6RU15	US15	43.00	
DKV6RU15A	US15A	43.00	
DKV6RU19	US19	43.00	
DKV6RU26	US26	43.00	
DKV6RU26D	US26D	43.00	
DKV6RCR003	CR003	46.00	



7 1/2"x 4" / Victorian Rope

Part Number	Finish	List Price Each	BOX QTY 1 PC
DKR75U3	US3	37.00	CASE QTY 20 PC
DKR75U5	US5	40.00	
DKR75U10B	US10B	40.00	
DKR75U15	US15	40.00	
DKR75U15A	US15A	40.00	
DKR75U19	US19	40.00	
DKR75U26	US26	40.00	
DKR75U26D	US26D	40.00	
DKR75CR003	CR003	44.00	



6"x 3" / With Viewer

Part Number	Finish	List Price Each	BOX QTY 20 PC
DKV630U3	US3	31.00	CASE QTY 100 PC
DKV630U5	US5	34.00	
DKV630U10B	US10B	34.00	
DKV630U15	US15	34.00	
DKV630U15A	US15A	34.00	
DKV630U19	US19	34.00	
DKV630U26	US26	34.00	
DKV630U26D	US26D	34.00	
DKV630CR003	CR003	36.00	



Door Viewer / Glass Lens / Solid Brass

Part Number	Finish	List Price Each	BOX QTY 12 PC
55211U3-UL	US3	7.00	CASE QTY 600 PC
55211U5-UL	US5	7.50	
55211U10B-UL	US10B	7.50	
55211U15-UL	US15	7.50	
55211U15A-UL	US15A	7.50	
55211U19-UL	US19	7.50	
55211U26-UL	US26	7.50	
55211U26D-UL	US26D	7.50	
55211CR003-UL	CR003	8.00	



Pocket Locks / Solid Brass

Adjustable
3 1/4" x 2 1/4" / Heavy Duty / Receiver

Part Number	Finish	List Price Each	BOX QTY
SDAR325U3	US3	21.50	10 PC
SDAR325U5	US5	23.00	
SDAR325U10B	US10B	23.00	CASE QTY
SDAR325U14	US14	23.00	50 PC
SDAR325U15	US15	23.00	
SDAR325U15A	US15A	23.00	CASE WEIGHT
SDAR325U19	US19	23.00	34 LB
SDAR325U26	US26	23.00	
SDAR325U26D	US26D	23.00	



Receiver Function

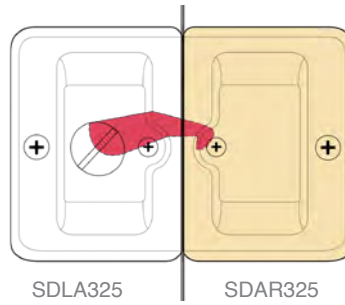

SDLA325 SDAR325

Locks two pocket doors together

Adjustable
3 1/4" x 2 1/4" / Heavy Duty / Privacy

Part Number	Finish	List Price Each	BOX QTY
SDLA325U3	US3	30.00	10 PC
SDLA325U3-UNL	US3-UNL	30.00	
SDLA325U5	US5	32.00	CASE QTY
SDLA325U10B	US10B	32.00	50 PC
SDLA325U14	US14	32.00	
SDLA325U15	US15	32.00	CASE WEIGHT
SDLA325U15A	US15A	32.00	30 LB
SDLA325U19	US19	32.00	
SDLA325U26	US26	32.00	
SDLA325U3/26	US3/26	32.00	
SDLA325U26D	US26D	34.00	
SDLA325CR003	CR003	37.50	



2 1/2" x 2 3/4" / Privacy

Part Number	Finish	List Price Each	BOX QTY
SDL25U3	US3	16.50	10 PC
SDL25U5	US5	18.00	
SDL25U10B	US10B	18.00	CASE QTY
SDL25U14	US14	18.00	50 PC
SDL25U15	US15	18.00	
SDL25U15A	US15A	18.00	CASE WEIGHT
SDL25U19	US19	18.00	21 LB
SDL25U26	US26	18.00	
SDL25U3/26	US3/26	19.00	
SDL25U26D	US26D	18.00	
SDL25CR003	CR003	20.50	



2 1/2" x 2 3/4" / Passage

Part Number	Finish	List Price Each	BOX QTY
SDP25U3	US3	13.50	10 PC
SDP25U5	US5	15.00	
SDP25U10B	US10B	15.00	CASE QTY
SDP25U14	US14	15.00	50 PC
SDP25U15	US15	15.00	
SDP25U15A	US15A	15.00	CASE WEIGHT
SDP25U19	US19	15.00	21 LB
SDP25U26	US26	15.00	
SDP25U3/26	US3/26	16.20	
SDP25U26D	US26D	15.00	
SDP25CR003	CR003	18.50	



US3 Exterior / US26 Interior

Adjustable
3 1/4" x 2 1/4" / Heavy Duty / Passage

Part Number	Finish	List Price Each	BOX QTY
SDPA325U3	US3	25.60	10 PC
SDPA325U3-UNL	US3-UNL	25.60	
SDPA325U5	US5	26.50	CASE QTY
SDPA325U10B	US10B	26.50	50 PC
SDPA325U14	US14	26.50	
SDPA325U15	US15	26.50	CASE WEIGHT
SDPA325U15A	US15A	26.50	30 LB
SDPA325U19	US19	26.50	
SDPA325U26	US26	26.50	
SDPA325U3/26	US3/26	28.00	
SDPA325U26D	US26D	26.50	
SDPA325CR003	CR003	33.80	



US3 Exterior / US26 Interior

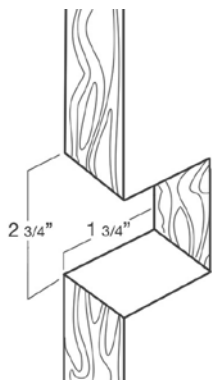

Fits Door Thickness: 1 3/8" ~ 1 3/4"

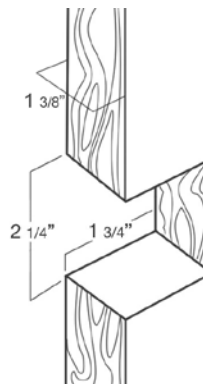

Fits Door Thickness: 1 3/8"

Decorative Pocket Locks / Solid Brass

Pocket Door Bolt / Solid Brass

6"x 2 1/2" / Privacy

Part Number	Finish	List Price Each	BOX QTY 5 PC
SDL60U3	US3	40.00	CASE QTY 50 PC
SDL60U5	US5	42.00	
SDL60U10B	US10B	42.00	CASE WEIGHT 27 LB
SDL60U14	US14	42.00	
SDL60U15	US15	42.00	
SDL60U26	US26	42.00	



3"x 1 1/4" / Jamb Bolt

Part Number	Finish	List Price Each	BOX QTY 40 PC
PDB42U3	US3	8.80	CASE QTY 400 PC
PDB42U3-UNL	US3-UNL	8.80	
PDB42U5	US5	11.00	CASE WEIGHT 27 LB
PDB42U10B	US10B	11.00	
PDB42U14	US14	11.00	
PDB42U15	US15	11.00	
PDB42U15A	US15A	11.00	
PDB42U19	US19	11.00	
PDB42U26	US26	11.00	
PDB42U26D	US26D	11.00	
PDB42CR003	CR003	13.00	



6"x 2 1/2" / Passage

Part Number	Finish	List Price Each	BOX QTY 5 PC
SDP60U3	US3	37.00	CASE QTY 50 PC
SDP60U5	US5	39.00	
SDP60U10B	US10B	39.00	CASE WEIGHT 27 LB
SDP60U14	US14	39.00	
SDP60U15	US15	39.00	
SDP60U26	US26	39.00	

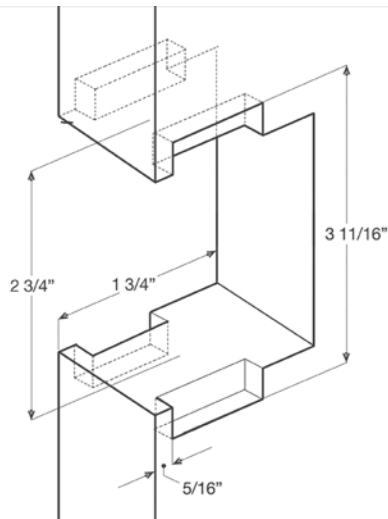
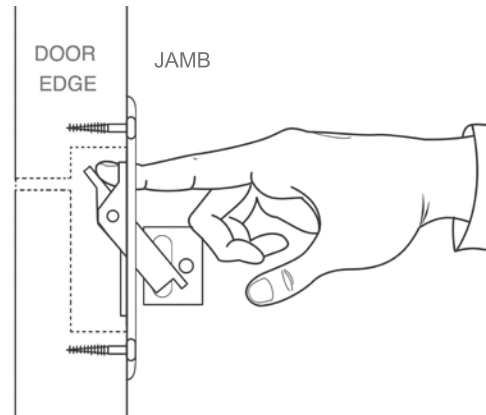

Fits Door Thickness: 1 3/8" ~ 1 5/8"

This is an unfamiliar but useful piece of hardware to lock pocket doors. It is mounted on interior side of a pocket door near the jamb face. When the top half is pushed in the bottom half pops out preventing the door from returning into its pocket.

A strike is provided to protect the jamb. Emergency release is accomplished by drilling a small hole on the exterior face of the door. Insert a thin object into this hole to push the rocker back into the unlocked position.

Home Accessories

	Pages
Hand Rail Brackets.....	9 - 2
Cabin Hooks.....	9 - 2
Valet Hook.....	9 - 3
Drop Latch.....	9 - 3
Garment Hooks.....	9 - 3
Robe Hooks.....	9 - 4
Switch Plates.....	9 - 5
Flag Pole Holders.....	9 - 6
Solid Brass Letters 4".....	9 - 7
Solid Brass House Numbers 4" & 6".....	9 - 9
Zinc Die-Cast House Numbers 4".....	9 - 10

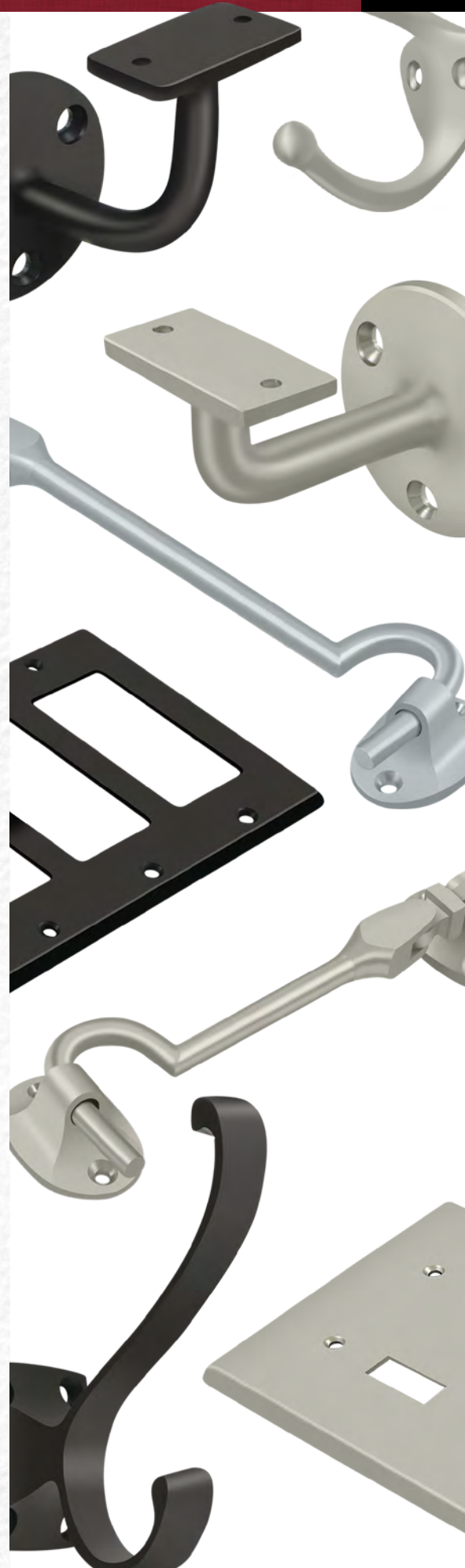

 Custom finish plating available.

HOME ACCESSORIES

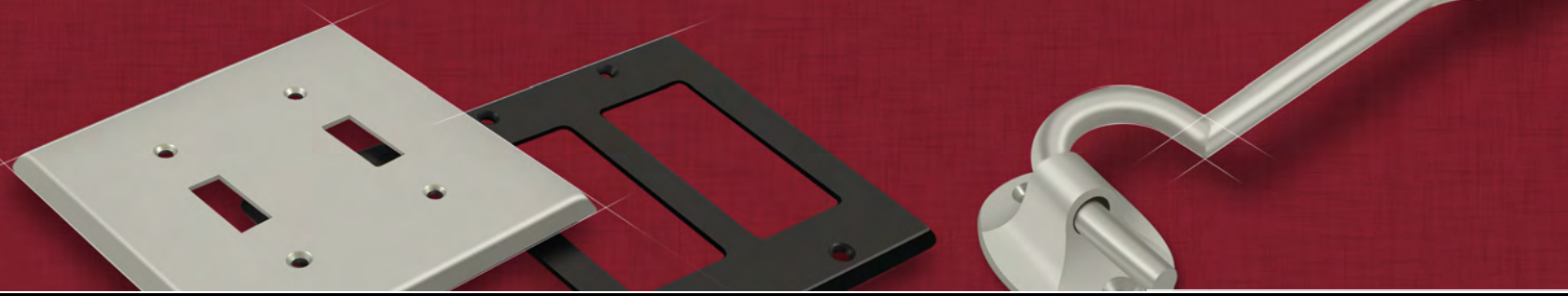

Hand Rail Brackets / Solid Brass

Hand Rail Brackets

3" Projection / Solid Brass

Part Number	Finish	List Price Each	BASE DIAMETER
HRC253U3	US3	25.00	2 1/4"
HRC253U5	US5	28.00	
HRC253U10B	US10B	28.00	BOX QTY 5 PC
HRC253U15	US15	28.00	
HRC253U15A	US15A	28.00	CASE QTY 50 PC
HRC253U19	US19	28.00	
HRC253U26	US26	28.00	CASE WEIGHT 30 LB
HRC253U26D	US26D	28.00	
HRC253CR003	CR003	30.00	



3 3/8" Projection / Solid Brass

Part Number	Finish	List Price Each	BASE DIAMETER
HRB325U3	US3	18.20	2 1/4" x 2 1/2"
HRB325U5	US5	20.90	
HRB325U10B	US10B	20.90	BOX QTY 10 PC
HRB325U15	US15	20.90	
HRB325U15A	US15A	20.90	CASE QTY 100 PC
HRB325U19	US19	20.90	
HRB325U26	US26	20.90	CASE WEIGHT 35 LB
HRB325U26D	US26D	20.90	
HRB325CR003	CR003	24.00	



3 1/4" Projection / Solid Brass

Part Number	Finish	List Price Each	BASE DIAMETER
HRC175U3	US3	21.50	2 1/4"
HRC175U5	US5	23.50	
HRC175U10B	US10B	23.50	BOX QTY 5 PC
HRC175U15	US15	23.50	
HRC175U15A	US15A	23.50	CASE QTY 50 PC
HRC175U19	US19	23.50	
HRC175U26	US26	23.50	CASE WEIGHT 30 LB
HRC175U26D	US26D	23.50	
HRC175CR003	CR003	27.00	



3 1/4" Projection / Zinc Die Cast

Part Number	Finish	List Each	BASE DIAMETER
ZHRBB325U3	US3	7.50	1 1/4" x 2 1/4"
ZHRBB325U5	US5	7.50	
ZHRBB325U10B	US10B	7.50	BOX QTY 50 PC
ZHRBB325U15	US15	7.50	
ZHRBB325U15A	US15A	7.50	CASE QTY 150 PC
ZHRBB325U26	US26	7.50	
ZHRBB325U26D	US26D	7.50	CASE WEIGHT 28 LB



Cabin Hooks / Solid Brass

4" / British Style

Part Number	Finish	List Price Each	BOX QTY
CHB4U3	US3	20.00	5 PC
CHB4U5	US5	21.50	
CHB4U10B	US10B	21.50	CASE QTY 100 PC
CHB4U15	US15	21.50	
CHB4U15A	US15A	21.50	CASE QTY 200 PC
CHB4U19	US19	21.50	
CHB4U26	US26	21.50	CASE QTY 200 PC
CHB4U26D	US26D	21.50	
CHB4CR003	CR003	24.50	



6" / British Style

Part Number	Finish	List Each	BOX QTY
CHB6U3	US3	24.80	5 PC
CHB6U5	US5	27.00	
CHB6U10B	US10B	27.00	CASE QTY 100 PC
CHB6U15	US15	27.00	
CHB6U15A	US15A	27.00	CASE QTY 200 PC
CHB6U19	US19	27.00	
CHB6U26	US26	27.00	CASE QTY 200 PC
CHB6U26D	US26D	27.00	
CHB6CR003	CR003	29.00	



4" / Contemporary

Part Number	Finish	List Price Each	BOX QTY
CHK4U3	US3	16.50	20 PC
CHK4U5	US5	18.00	
CHK4U10B	US10B	18.00	CASE QTY 200 PC
CHK4U15	US15	18.00	
CHK4U15A	US15A	18.00	CASE QTY 200 PC
CHK4U19	US19	18.00	
CHK4U26	US26	18.00	CASE QTY 200 PC
CHK4U26D	US26D	18.00	
CHK4CR003	CR003	21.00	



Additional Cabin Hook Eye Available. See 12 - 3.

6" / Contemporary

Part Number	Finish	List Price Each	BOX QTY
CHK6U3	US3	21.00	15 PC
CHK6U5	US5	23.00	
CHK6U10B	US10B	23.00	CASE QTY 150 PC
CHK6U15	US15	23.00	
CHK6U15A	US15A	23.00	CASE QTY 150 PC
CHK6U19	US19	23.00	
CHK6U26	US26	23.00	CASE QTY 150 PC
CHK6U26D	US26D	23.00	
CHK6CR003	CR003	25.00	



Additional Cabin Hook Eye Available. See 12 - 3.

Valet Hook / Solid Brass

7" Projection

Part Number	Finish	List Price Each	BASE 3 1/4" x 1 5/8"
VH65U3	US3	25.80	BOX QTY 20 PC
VH65U5	US5	27.50	
VH65U10B	US10B	27.50	CASE QTY 100 PC
VH65U15	US15	27.50	
VH65U15A	US15A	27.50	CASE WEIGHT 40 LB
VH65U19	US19	27.50	
VH65U26	US26	27.50	
VH65U26D	US26D	27.50	
VH65CR003	CR003	29.00	

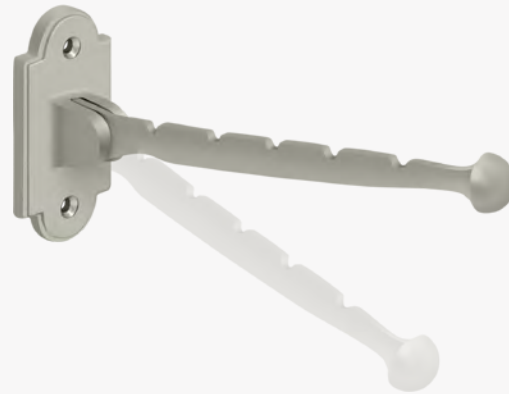

Hook extends 90°

Drop Latch / Solid Brass

3 1/2" Drop Latch

Part Number	Finish	List Price Each	BOX QTY 20 PC
DL35U3	US3	24.00	
DL35U5	US5	26.50	
DL35U10B	US10B	26.50	
DL35U15	US15	26.50	
DL35U15A	US15A	26.50	
DL35U26	US26	26.50	
DL35U26D	US26D	26.50	
DL35CR003	CR003	29.00	



Garment Hooks / Solid Brass

2 3/4" x 1 5/8" Double Hook

Part Number	Finish	List Price Each	BOX QTY 30 PC
WDH15U3	US3	7.50	CASE QTY 300 PC
WDH15U5	US5	8.50	
WDH15U10B	US10B	8.50	CASE WEIGHT 33 LB
WDH15U14	US14	8.50	
WDH15U15	US15	8.50	
WDH15U15A	US15A	8.50	
WDH15U19	US19	8.50	
WDH15U26	US26	8.50	
WDH15U26D	US26D	8.50	
WDH15CR003	CR003	10.50	



3 1/2" Projection Coat & Hat Hook / Heavy Duty

Part Number	Finish	List Price Each	BASE 1 5/8" x 1 1/4"
CAHH35U3	US3	14.00	BOX QTY 20 PC
CAHH35U3-UNL	US3-UNL	14.00	
CAHH35U5	US5	15.50	CASE QTY 200 PC
CAHH35U10B	US10B	15.50	
CAHH35U14	US14	15.50	CASE WEIGHT 40 LB
CAHH35U15	US15	15.50	
CAHH35U15A	US15A	15.50	
CAHH35U19	US19	15.50	
CAHH35U26	US26	15.50	
CAHH35U26D	US26D	15.50	
CAHH35CR003	CR003	17.50	



3 1/4" Projection Coat & Hat Hook

Part Number	Finish	List Price Each	BASE 1 3/8" x 1 1/8"
CAHH3U3	US3	9.20	BOX QTY 20 PC
CAHH3U3-UNL	US3-UNL	9.20	
CAHH3U5	US5	10.20	CASE QTY 200 PC
CAHH3U10B	US10B	10.20	
CAHH3U14	US14	10.20	CASE WEIGHT 40 LB
CAHH3U15	US15	10.20	
CAHH3U15A	US15A	10.20	
CAHH3U19	US19	10.20	
CAHH3U26	US26	10.20	
CAHH3U26D	US26D	10.20	
CAHH3CR003	CR003	11.80	



4" Projection Triple Swivel Hook

Part Number	Finish	List Price Each	BASE 3 1/8" x 1 1/2"
TSH40U3	US3	28.80	BOX QTY 5 PC
TSH40U5	US5	31.00	
TSH40U10B	US10B	31.00	CASE QTY 50 PC
TSH40U15	US15	31.00	
TSH40U15A	US15A	31.00	CASE WEIGHT 30 LB
TSH40U19	US19	31.00	
TSH40U26	US26	31.00	
TSH40U26D	US26D	31.00	
TSH40CR003	CR003	33.00	



Robe Hooks

55D-Series Double Robe Hook

Part Number	Finish	List Each	BASE SIZE
55D2010-4	US4	38.00	1 7/8" x 1 1/4"
55D2010-14	US14	38.00	PROJECTS 2 1/2"
55D2010-15	US15	38.00	
55D2010-26	US26	38.00	

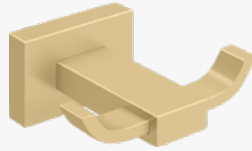
BBS-Series Double Robe Hook / Solid Brass

Part Number	Finish	List Each	BASE DIAMETER
BBS2010-10B	US10B	45.00	2"
BBS2010-15	US15	45.00	PROJECTS 3 1/4"
BBS2010-14	US14	45.00	
BBS2010-26	US26	45.00	

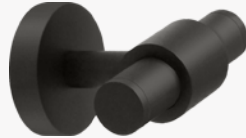
BBN-Series Single Robe Hook / Zinc

Part Number	Finish	List Each	BASE DIAMETER
BBN2009-15	US15	17.00	1 3/4"
BBN2009-26	US26	17.00	PROJECTS 3 1/8"

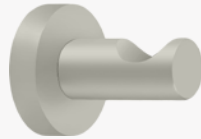
BBN-Series Double Robe Hook / Zinc

Part Number	Finish	List Each	BASE DIAMETER
BBN2010-15	US15	20.00	1 3/4"
BBN2010-26	US26	20.00	PROJECTS 3 1/8"

88-Series Single Robe Hook / Solid Brass

Part Number	Finish	List Each	BASE DIAMETER
88SRH-15	US15	46.00	2 5/8"
88SRH-26	US26	46.00	PROJECTS 3 1/8"

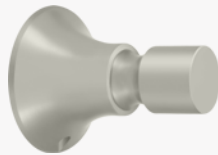
88-Series Double Robe Hook / Solid Brass

Part Number	Finish	List Each	BASE DIAMETER
88DRH-15	US15	53.00	2 5/8"
88DRH-26	US26	53.00	PROJECTS 3 1/8"

**Zinc & Aluminum
ZA-Series Double Robe Hook**

Part Number	Finish	List Each	BASE SIZE
ZA2010-15	US15	17.00	1 1/8"
ZA2010-26	US26	17.00	PROJECTS 1 3/4"

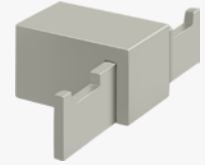
**Zinc & Aluminum
ZA-Series Single Robe Hook**

Part Number	Finish	List Each	BASE SIZE
ZA2009-15	US15	14.00	1 1/8"
ZA2009-26	US26	14.00	PROJECTS 1 3/4"

BBS-Series Single Robe Hook / Solid Brass

Part Number	Finish	List Each	BASE DIAMETER
BBS2009-10B	US10B	28.00	2"
BBS2009-14	US14	28.00	PROJECTS 1 1/2"
BBS2009-15	US15	28.00	
BBS2009-26	US26	28.00	

R-Series Single Robe Hook / Solid Brass

Part Number	Finish	List Each	BASE DIAMETER
R2009-U10B	US10B	30.00	2 5/8"
R2009-U14	US14	30.00	PROJECTS 3 1/2"
R2009-U15	US15	30.00	
R2009-U15A	US15A	30.00	
R2009-U19	US19	30.00	
R2009-U26	US26	30.00	
R2009-U26/3	US26/3	30.00	
R2009-CR003	CR003	34.00	

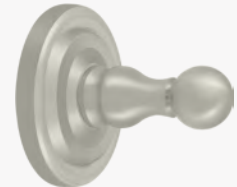
R-Series Double Robe Hook / Solid Brass

Part Number	Finish	List Each	BASE DIAMETER
R2010-U10B	US10B	44.00	2 5/8"
R2010-U14	US14	44.00	PROJECTS 3 1/2"
R2010-U15	US15	44.00	
R2010-U15A	US15A	44.00	
R2010-U19	US19	44.00	
R2010-U26	US26	44.00	
R2010-U26/3	US26/3	44.00	
R2010-CR003	CR003	48.00	



Switch Plates / Solid Brass

4 1/2" x 2 3/4" Single Standard

Part Number	Finish	List Price Each	BOX QTY 40 PC
SWP4751U3	US3	13.20	CASE QTY 160 PC
SWP4751U5	US5	14.50	
SWP4751U10B	US10B	14.50	
SWP4751U15	US15	14.50	
SWP4751U15A	US15A	14.50	
SWP4751U26	US26	14.50	
SWP4751U26D	US26D	14.50	
SWP4751CR003	CR003	16.90	

4 1/2" x 4 1/2" Double Standard

Part Number	Finish	List Price Each	BOX QTY 20 PC
SWP4761U3	US3	20.00	CASE QTY 120 PC
SWP4761U5	US5	21.20	
SWP4761U10B	US10B	21.20	
SWP4761U15	US15	21.20	
SWP4761U15A	US15A	21.20	
SWP4761U26	US26	21.20	
SWP4761U26D	US26D	21.20	
SWP4761CR003	CR003	23.30	

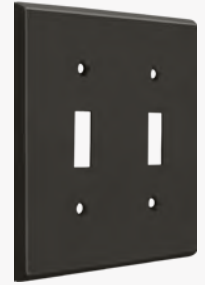
4 1/2" x 6 1/2" Triple Standard

Part Number	Finish	List Price Each	BOX QTY 20 PC
SWP4763U3	US3	26.00	CASE QTY 120 PC
SWP4763U5	US5	27.10	
SWP4763U10B	US10B	27.10	
SWP4763U15	US15	27.10	
SWP4763U15A	US15A	27.10	
SWP4763U19	US19	27.10	
SWP4763U26	US26	27.10	
SWP4763U26D	US26D	27.10	
SWP4763CR003	CR003	29.40	

4 1/2" x 4 1/2" Single Standard & Rocker

Part Number	Finish	List Price Each	BOX QTY 20 PC
SWP4743U3	US3	17.70	CASE QTY 120 PC
SWP4743U5	US5	18.70	
SWP4743U10B	US10B	18.70	
SWP4743U15	US15	18.70	
SWP4743U15A	US15A	18.70	
SWP4743U19	US19	18.70	
SWP4743U26	US26	18.70	
SWP4743U26D	US26D	18.70	
SWP4743CR003	CR003	20.70	

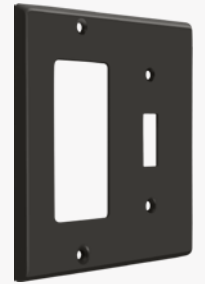
4 1/2" x 2 3/4" Single Rocker

Part Number	Finish	List Price Each	BOX QTY 40 PC
SWP4754U3	US3	12.60	CASE QTY 160 PC
SWP4754U5	US5	13.90	
SWP4754U10B	US10B	13.90	
SWP4754U15	US15	13.90	
SWP4754U15A	US15A	13.90	
SWP4754U19	US19	13.90	
SWP4754U26	US26	13.90	
SWP4754U26D	US26D	13.90	
SWP4754CR003	CR003	16.00	

4 1/2" x 2 3/4" Double Outlet

Part Number	Finish	List Price Each	BOX QTY 40 PC
SWP4752U3	US3	13.20	CASE QTY 160
SWP4752U5	US5	14.50	
SWP4752U10B	US10B	14.50	
SWP4752U15	US15	14.50	
SWP4752U15A	US15A	14.50	
SWP4752U26	US26	14.50	
SWP4752U26D	US26D	14.50	
SWP4752CR003	CR003	16.90	

4 1/2" x 4 1/2" Double Rocker

Part Number	Finish	List Price Each	BOX QTY 20 PC
SWP4741U3	US3	20.00	CASE QTY 120 PC
SWP4741U5	US5	21.20	
SWP4741U10B	US10B	21.20	
SWP4741U15	US15	21.20	
SWP4741U15A	US15A	21.20	
SWP4741U19	US19	21.20	
SWP4741U26	US26	21.20	
SWP4741U26D	US26D	21.20	
SWP4741CR003	CR003	23.30	

4 1/2" x 4 1/2" Quadruple Outlet

Part Number	Finish	List Price Each	BOX QTY 20 PC
SWP4771U3	US3	20.00	CASE QTY 120 PC
SWP4771U5	US5	21.20	
SWP4771U10B	US10B	21.20	
SWP4771U15	US15	21.20	
SWP4771U15A	US15A	21.20	
SWP4771U26	US26	21.20	
SWP4771U26D	US26D	21.20	
SWP4771CR003	CR003	23.30	

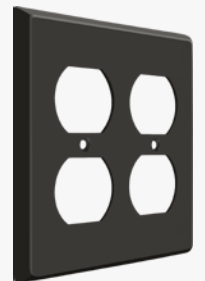

Switch Plates / Solid Brass

4 5/8" x 6 3/8" Triple Rocker

Part Number	Finish	List Price Each	BOX QTY 20 PC
SWP4740U3	US3	26.00	CASE QTY 120 PC
SWP4740U5	US5	27.10	
SWP4740U10B	US10B	27.10	
SWP4740U15	US15	27.10	
SWP4740U15A	US15A	27.10	
SWP4740U19	US19	27.10	
SWP4740U26	US26	27.10	
SWP4740U26D	US26D	27.10	
SWP4740CR003	CR003	29.40	

4 1/2" x 4 1/2"
Single Standard & Double Outlet

Part Number	Finish	List Price Each	BOX QTY 20 PC
SWP4762U3	US3	17.70	CASE QTY 120 PC
SWP4762U5	US5	18.70	
SWP4762U10B	US10B	18.70	
SWP4762U15	US15	18.70	
SWP4762U15A	US15A	18.70	
SWP4762U19	US19	18.70	
SWP4762U26	US26	18.70	
SWP4762U26D	US26D	18.70	
SWP4762CR003	CR003	20.80	

4 5/8" x 8 1/8" Quadruple Rocker

Part Number	Finish	List Price Each	BOX QTY 20 PC
SWP4744U3	US3	31.60	CASE QTY 120 PC
SWP4744U5	US5	33.00	
SWP4744U10B	US10B	33.00	
SWP4744U15	US15	33.00	
SWP4744U15A	US15A	33.00	
SWP4744U19	US19	33.00	
SWP4744U26	US26	33.00	
SWP4744U26D	US26D	33.00	
SWP4744CR003	CR003	35.70	

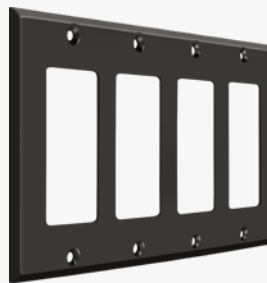
4 1/2" x 2 3/4" Cable Cover Plate

Part Number	Finish	List Price Each	BOX QTY 40 PC
CPC4764U3	US3	13.20	CASE QTY 160 PC
CPC4764U5	US5	14.50	
CPC4764U10B	US10B	14.50	
CPC4764U15	US15	14.50	
CPC4764U15A	US15A	14.50	
CPC4764U19	US19	14.50	
CPC4764U26	US26	14.50	
CPC4764U26D	US26D	14.50	
CPC4764CR003	CR003	16.90	



Flag Pole Holders / Solid Brass

1" Diameter Capacity Flag Pole Holder

Part Number	Finish	List Price Each	HEIGHT 5 1/4"	
FPH10U5	US5	26.80	BOX QTY 1 PC	
FPH10U15	US15	26.80		
FPH10U15A	US15A	26.80		
FPH10U19	US19	26.80		
FPH10U26	US26	26.80		
FPH10U26D	US26D	26.80		
				CASE QTY 50 PC
				CASE WEIGHT 45 LB

3/4" Diameter Capacity Flag Pole Holder

Part Number	Finish	List Price Each	HEIGHT 4"
FPH75U3	US3	21.00	BOX QTY 1 PC
FPH75U5	US5	24.00	
FPH75U10B	US10B	24.00	
FPH75U15	US15	24.00	
FPH75U15A	US15A	24.00	
FPH75U19	US19	24.00	
FPH75U26	US26	24.00	
FPH75U26D	US26D	24.00	
FPH75CR003	CR003	25.80	
			CASE QTY 50 PC
			CASE WEIGHT 30 LB



4" Letters / Solid Brass

Letter A

Part Number	Finish	List Price Each	BOX QTY 10 PC
RL4A-10B	US10B	15.50	
RL4A-15	US15	15.50	
RL4A-15A	US15A	15.50	
RL4A-CR003	CR003	19.80	

Letter G

Part Number	Finish	List Price Each	BOX QTY 10 PC
RL4G-10B	US10B	15.50	
RL4G-15	US15	15.50	
RL4G-15A	US15A	15.50	
RL4G-CR003	CR003	19.80	

Letter B

Part Number	Finish	List Price Each	CASE QTY 10 PC
RL4B-10B	US10B	15.50	
RL4B-15	US15	15.50	
RL4B-15A	US15A	15.50	
RL4B-CR003	CR003	19.80	

Letter H

Part Number	Finish	List Price Each	BOX QTY 10 PC
RL4H-10B	US10B	15.50	
RL4H-15	US15	15.50	
RL4H-15A	US15A	15.50	
RL4H-CR003	CR003	19.80	

Letter C

Part Number	Finish	List Price Each	BOX QTY 10 PC
RL4C-10B	US10B	15.50	
RL4C-15	US15	15.50	
RL4C-15A	US15A	15.50	
RL4C-CR003	CR003	19.80	

Letter I

Part Number	Finish	List Price Each	BOX QTY 10 PC
RL4I-10B	US10B	15.50	
RL4I-15	US15	15.50	
RL4I-15A	US15A	15.50	
RL4I-CR003	CR003	19.80	

Letter D

Part Number	Finish	List Price Each	BOX QTY 10 PC
RL4D-10B	US10B	15.50	
RL4D-15	US15	15.50	
RL4D-15A	US15A	15.50	
RL4D-CR003	CR003	19.80	

Letter J

Part Number	Finish	List Price Each	BOX QTY 10 PC
RL4J-10B	US10B	15.50	
RL4J-15	US15	15.50	
RL4J-15A	US15A	15.50	
RL4J-CR003	CR003	19.80	

Letter E

Part Number	Finish	List Price Each	BOX QTY 10 PC
RL4E-10B	US10B	15.50	
RL4E-15	US15	15.50	
RL4E-15A	US15A	15.50	
RL4E-CR003	CR003	19.80	

Letter K

Part Number	Finish	List Price Each	BOX QTY 10 PC
RL4K-10B	US10B	15.50	
RL4K-15	US15	15.50	
RL4K-15A	US15A	15.50	
RL4K-CR003	CR003	19.80	

Letter F

Part Number	Finish	List Price Each	BOX QTY 10 PC
RL4F-10B	US10B	15.50	
RL4F-15	US15	15.50	
RL4F-15A	US15A	15.50	
RL4F-CR003	CR003	19.80	

Letter L

Part Number	Finish	List Price Each	BOX QTY 10 PC
RL4L-10B	US10B	15.50	
RL4L-15	US15	15.50	
RL4L-15A	US15A	15.50	
RL4L-CR003	CR003	19.80	



4" Letters / Solid Brass

Letter M

Part Number	Finish	List Price Each	BOX QTY 10 PC
RL4M-10B	US10B	15.50	
RL4M-15	US15	15.50	
RL4M-15A	US15A	15.50	
RL4M-CR003	CR003	19.80	

Letter S

Part Number	Finish	List Price Each	BOX QTY 10 PC
RL4S-10B	US10B	15.50	
RL4S-15	US15	15.50	
RL4S-15A	US15A	15.50	
RL4S-CR003	CR003	19.80	

Letter N

Part Number	Finish	List Price Each	BOX QTY 10 PC
RL4N-10B	US10B	15.50	
RL4N-15	US15	15.50	
RL4N-15A	US15A	15.50	
RL4N-CR003	CR003	19.80	

Letter T

Part Number	Finish	List Price Each	BOX QTY 10 PC
RL4T-10B	US10B	15.50	
RL4T-15	US15	15.50	
RL4T-15A	US15A	15.50	
RL4T-CR003	CR003	19.80	

Letter O

Part Number	Finish	List Price Each	BOX QTY 10 PC
RL4O-10B	US10B	15.50	
RL4O-15	US15	15.50	
RL4O-15A	US15A	15.50	
RL4O-CR003	CR003	19.80	

Letter U

Part Number	Finish	List Price Each	BOX QTY 10 PC
RL4U-10B	US10B	15.50	
RL4U-15	US15	15.50	
RL4U-15A	US15A	15.50	
RL4U-CR003	CR003	19.80	

Letter P

Part Number	Finish	List Price Each	BOX QTY 10 PC
RL4P-10B	US10B	15.50	
RL4P-15	US15	15.50	
RL4P-15A	US15A	15.50	
RL4P-CR003	CR003	19.80	

Letter V

Part Number	Finish	List Price Each	BOX QTY 10 PC
RL4V-10B	US10B	15.50	
RL4V-15	US15	15.50	
RL4V-15A	US15A	15.50	
RL4V-CR003	CR003	19.80	

Letter Q

Part Number	Finish	List Price Each	CASE QTY 10 PC
RL4Q-10B	US10B	15.50	
RL4Q-15	US15	15.50	
RL4Q-15A	US15A	15.50	
RL4Q-CR003	CR003	19.80	

Letter W

Part Number	Finish	List Price Each	BOX QTY 10 PC
RL4W-10B	US10B	15.50	
RL4W-15	US15	15.50	
RL4W-15A	US15A	15.50	
RL4W-CR003	CR003	19.80	

Letter R

Part Number	Finish	List Price Each	BOX QTY 10 PC
RL4R-10B	US10B	15.50	
RL4R-15	US15	15.50	
RL4R-15A	US15A	15.50	
RL4R-CR003	CR003	19.80	

Letter X

Part Number	Finish	List Price Each	BOX QTY 10 PC
RL4X-10B	US10B	15.50	
RL4X-15	US15	15.50	
RL4X-15A	US15A	15.50	
RL4X-CR003	CR003	19.80	



4" Letters / Solid Brass

Letter Y

Part Number	Finish	List Price Each	BOX QTY 10 PC
RL4Y-10B	US10B	15.50	
RL4Y-15	US15	15.50	
RL4Y-15A	US15A	15.50	
RL4Y-CR003	CR003	19.80	

Letter Z

Part Number	Finish	List Price Each	BOX QTY 10 PC
RL4Z-10B	US10B	15.50	
RL4Z-15	US15	15.50	
RL4Z-15A	US15A	15.50	
RL4Z-CR003	CR003	19.80	



4" & 6" House Numbers / Solid Brass

4" Number 1

Part Number	Finish	List Price Each	BOX QTY 10 PC
RN4-1U10B	US10B	12.40	
RN4-1U15	US15	12.40	
RN4-1U15A	US15A	12.40	
RN4-1	CR003	17.50	

6" Number 1

Part Number	Finish	List Price Each	BOX QTY 10 PC
RN6-1U10B	US10B	20.50	
RN6-1U15	US15	20.50	
RN6-1U15A	US15A	20.50	
RN6-1	CR003	22.10	

4" Number 2

Part Number	Finish	List Price Each	BOX QTY 10 PC
RN4-2U10B	US10B	12.40	
RN4-2U15	US15	12.40	
RN4-2U15A	US15A	12.40	
RN4-2	CR003	17.50	

6" Number 2

Part Number	Finish	List Price Each	BOX QTY 10 PC
RN6-2U10B	US10B	20.50	
RN6-2U15	US15	20.50	
RN6-2U15A	US15A	20.50	
RN6-2	CR003	22.10	

4" Number 3

Part Number	Finish	List Price Each	BOX QTY 10 PC
RN4-3U10B	US10B	12.40	
RN4-3U15	US15	12.40	
RN4-3U15A	US15A	12.40	
RN4-3	CR003	17.50	

6" Number 3

Part Number	Finish	List Price Each	BOX QTY 10 PC
RN6-3U10B	US10B	20.50	
RN6-3U15	US15	20.50	
RN6-3U15A	US15A	20.50	
RN6-3	CR003	22.10	

4" Number 4

Part Number	Finish	List Price Each	BOX QTY 10 PC
RN4-4U10B	US10B	12.40	
RN4-4U15	US15	12.40	
RN4-4U15A	US15A	12.40	
RN4-4	CR003	17.50	

6" Number 4

Part Number	Finish	List Price Each	BOX QTY 10 PC
RN6-4U10B	US10B	20.50	
RN6-4U15	US15	20.50	
RN6-4U15A	US15A	20.50	
RN6-4	CR003	22.10	

4" Number 5

Part Number	Finish	List Price Each	BOX QTY 10 PC
RN4-5U10B	US10B	12.40	
RN4-5U15	US15	12.40	
RN4-5U15A	US15A	12.40	
RN4-5	CR003	17.50	

6" Number 5

Part Number	Finish	List Price Each	BOX QTY 10 PC
RN6-5U10B	US10B	20.50	
RN6-5U15	US15	20.50	
RN6-5U15A	US15A	20.50	
RN6-5	CR003	22.10	



4" & 6" House Numbers / Solid Brass

4" Number 6

Part Number	Finish	List Price Each	BOX QTY 10 PC
RN4-6U10B	US10B	12.40	
RN4-6U15	US15	12.40	
RN4-6U15A	US15A	12.40	
RN4-6	CR003	17.50	

6" Number 6

Part Number	Finish	List Price Each	BOX QTY 10 PC
RN6-6U10B	US10B	20.50	
RN6-6U15	US15	20.50	
RN6-6U15A	US15A	20.50	
RN6-6	CR003	22.10	

4" Number 7

Part Number	Finish	List Price Each	BOX QTY 10 PC
RN4-7U10B	US10B	12.40	
RN4-7U15	US15	12.40	
RN4-7U15A	US15A	12.40	
RN4-7	CR003	17.50	

6" Number 7

Part Number	Finish	List Price Each	BOX QTY 10 PC
RN6-7U10B	US10B	20.50	
RN6-7U15	US15	20.50	
RN6-7U15A	US15A	20.50	
RN6-7	CR003	22.10	

4" Number 8

Part Number	Finish	List Price Each	BOX QTY 10 PC
RN4-8U10B	US10B	12.40	
RN4-8U15	US15	12.40	
RN4-8U15A	US15A	12.40	
RN4-8	CR003	17.50	

6" Number 8

Part Number	Finish	List Price Each	BOX QTY 10 PC
RN6-8U10B	US10B	20.50	
RN6-8U15	US15	20.50	
RN6-8U15A	US15A	20.50	
RN6-8	CR003	22.10	

4" Number 9

Part Number	Finish	List Price Each	BOX QTY 10 PC
RN4-9U10B	US10B	12.40	
RN4-9U15	US15	12.40	
RN4-9U15A	US15A	12.40	
RN4-9	CR003	17.50	

6" Number 9

Part Number	Finish	List Price Each	BOX QTY 10 PC
RN6-9U10B	US10B	20.50	
RN6-9U15	US15	20.50	
RN6-9U15A	US15A	20.50	
RN6-9	CR003	22.10	

4" Number 0

Part Number	Finish	List Price Each	BOX QTY 10 PC
RN4-0U10B	US10B	12.40	
RN4-0U15	US15	12.40	
RN4-0U15A	US15A	12.40	
RN4-0	CR003	17.50	

6" Number 0

Part Number	Finish	List Price Each	BOX QTY 10 PC
RN6-0U10B	US10B	20.50	
RN6-0U15	US15	20.50	
RN6-0U15A	US15A	20.50	
RN6-0	CR003	22.10	



4" House Numbers / Zinc Die Cast

4" House Numbers

Part Number	Finish	List Price Each	BOX QTY 100 PC
RNZ4-0	Black	2.40	
RNZ4-1	Black	2.40	
RNZ4-2	Black	2.40	
RNZ4-3	Black	2.40	
RNZ4-4	Black	2.40	
RNZ4-5	Black	2.40	
RNZ4-6	Black	2.40	
RNZ4-7	Black	2.40	
RNZ4-8	Black	2.40	
RNZ4-9	Black	2.40	

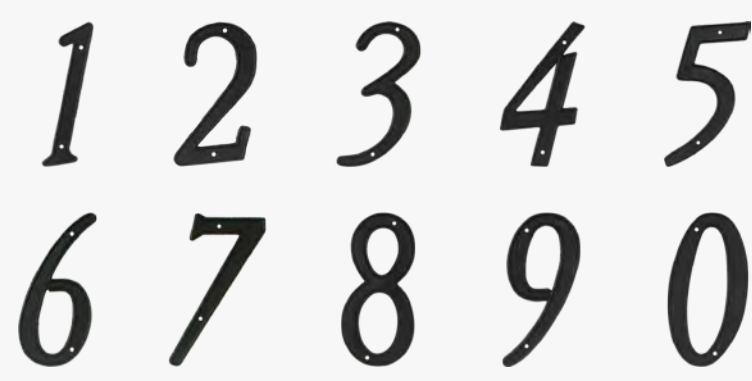

Window Hardware

	Pages
Casement Stay Adjusters.....	10 - 2
Shutter Bar, Door Latches.....	10 - 3
Window Locks / Casement Fasteners.....	10 - 3
Window Lift.....	10 - 3
Window Sash Locks.....	10 - 3
Shutter Door Holders.....	10 - 4
Transom Catch.....	10 - 4
Cabinet Locks.....	10 - 4
Sliding Door & Window Pin.....	10 - 4



➤ Custom finish plating available.

WINDOW HARDWARE



Casement Stay Adjusters / Solid Brass

13" Colonial

Part Number	Finish	List Price Each	BOX QTY 10 PC
CSA13U3	US3	46.70	CASE QTY 50 PC
CSA13U5	US5	48.00	
CSA13U10B	US10B	48.00	CASE WEIGHT 38 LB
CSA13U15	US15	48.00	
CSA13U15A	US15A	48.00	
CSA13U19	US19	48.00	
CSA13U26	US26	48.00	
CSA13U26D	US26D	48.00	
CSA13CR003	CR003	49.80	

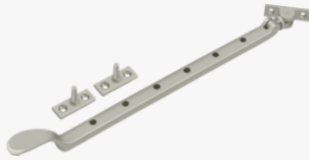

12" Heavy Duty

Part Number	Finish	List Price Each	BOX QTY 10 PC
CSA12HD3	US3	55.00	CASE QTY 50 LB
CSA12HD5	US5	57.00	
CSA12HD10B	US10B	57.00	CASE WEIGHT 55 LB
CSA12HD15	US15	57.00	
CSA12HD15A	US15A	57.00	
CSA12HD19	US19	57.00	
CSA12HD26	US26	57.00	
CSA12HD26D	US26D	57.00	
CSA12HDCR003	CR003	61.00	

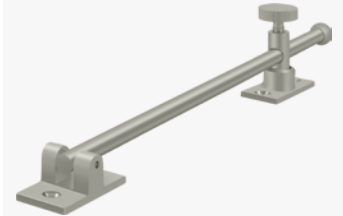

10" Standard

Part Number	Finish	List Price Each	BOX QTY 10 PC
CSA10U3	US3	41.50	CASE QTY 50 PC
CSA10U5	US5	44.20	
CSA10U10B	US10B	44.20	CASE WEIGHT 48 LB
CSA10U15	US15	44.20	
CSA10U15A	US15A	44.20	
CSA10U19	US19	44.20	
CSA10U26	US26	44.20	
CSA10U26D	US26D	44.20	
CSA10CR003	CR003	46.00	



12" Standard

Part Number	Finish	List Price Each	BOX QTY 10 PC
CSA12U3	US3	50.00	CASE QTY 50 PC
CSA12U5	US5	52.50	
CSA12U10B	US10B	52.50	CASE WEIGHT 50 LB
CSA12U15	US15	52.50	
CSA12U15A	US15A	52.50	
CSA12U19	US19	52.50	
CSA12U26	US26	52.50	
CSA12U26D	US26D	52.50	
CSA12CR003	CR003	54.50	



12" Friction Casement Stay

Part Number	Finish	List Price Each	BOX QTY 1 PC
FCA12U3	US3	47.80	CASE QTY 50 PC
FCA12U5	US5	49.00	
FCA12U10B	US10B	49.00	CASE WEIGHT 41 LB
FCA12U15	US15	49.00	
FCA12U15A	US15A	49.00	
FCA12U19	US19	49.00	
FCA12U26	US26	49.00	
FCA12U26D	US26D	49.00	
FCA12CR003	CR003	51.00	

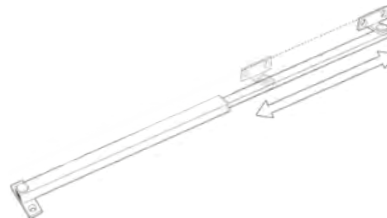

FCA12 fastener arm extends to the required position and holds open without the need to tighten a knob.

Shutter Bar Door Latches / Solid Brass

1 1/8" Latch

Part Number	Finish	List Price Each	BOX QTY 50 PC
SB3058U3	US3	7.70	
SB3058U5	US5	8.90	
SB3058U10B	US10B	8.90	
SB3058U15	US15	8.90	
SB3058U15A	US15A	8.90	
SB3058U26	US26	8.90	
SB3058U26D	US26D	8.90	
SB3058CR003	CR003	10.00	



1 3/8" Latch

Part Number	Finish	List Price Each	BOX QTY 40 PC
SB3178U3	US3	10.80	
SB3178U5	US5	11.70	
SB3178U10B	US10B	11.70	
SB3178U15	US15	11.70	
SB3178U15A	US15A	11.70	
SB3178U26	US26	11.70	
SB3178U26D	US26D	11.70	
SB3178CR003	CR003	13.90	



Window Locks / Casement Fasteners / Window Lift

4 1/2" Window Lock / Casement Fastener Solid Brass

Part Number	Finish	List Price Each	BOX QTY 10 PC	CASE QTY 100 PC	CASE WEIGHT 40 LB
CF450U3	US3	32.00			
CF450U5	US5	36.00			
CF450U10B	US10B	36.00			
CF450U15	US15	36.00			
CF450U15A	US15A	36.00			
CF450U19	US19	36.00			
CF450U26	US26	36.00			
CF450U26D	US26D	36.00			
CF450CR003	CR003	40.00			



Mortise Strike

Rim Strike

Window Lock / Casement Fastener / Small Solid Brass

Part Number	Finish	List Price Each	SIZE 1 5/8" x 7/8"	CASE QTY 200 PC
CF066U3	US3	17.00		
CF066U5	US5	18.80		
CF066U10B	US10B	18.80	PROJECTS 1 3/8"	CASE WEIGHT 38 LB
CF066U14	US14	18.80		
CF066U15	US15	18.80	BOX QTY 20 PC	
CF066U15A	US15A	18.80		
CF066U19	US19	18.80		
CF066U26	US26	18.80		
CF066U26D	US26D	18.80		
CF066CR003	CR003	22.00		

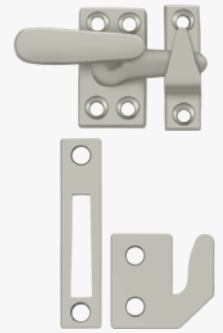

Window Lock / Casement Fastener / Medium Solid Brass

Part Number	Finish	List Price Each	SIZE 2 1/8" x 1 1/8"	CASE QTY 100 PC
CF66U3	US3	22.50		
CF66U5	US5	24.50		
CF66U10B	US10B	24.50	PROJECTS 1 7/8"	CASE WEIGHT 40 LB
CF66U14	US14	24.50		
CF66U15	US15	24.50	BOX QTY 10 PC	
CF66U15A	US15A	24.50		
CF66U19	US19	24.50		
CF66U26	US26	24.50		
CF66U26D	US26D	24.50		
CF66CR003	CR003	26.80		



1 1/2" x 1 5/8" Window Lift / Steel

Part Number	Finish	List Price Each	BOX QTY 20 PC	CASE QTY 360 PC
WL14U3	US3	3.90		
WL14U10B	US10B	4.80		
WL14U15	US15	4.80		
WL14U26	US26	4.80		



Window Sash Locks / Solid Brass

1" x 2 5/8"

Part Number	Finish	List Price Each	BOX QTY 25 PC	CASE QTY 250 PC
WL07U3	US3	14.60		
WL07U5	US5	16.00		
WL07U10B	US10B	16.00		
WL07U14	US14	16.00		
WL07U15	US15	16.00		
WL07U15A	US15A	16.00		
WL07U19	US19	16.00		
WL07U26	US26	16.00		
WL07U26D	US26D	16.00		
WL07CR003	CR003	17.80		



1 1/8" x 3"

Part Number	Finish	List Price Each	BOX QTY 15 PC	CASE QTY 150 PC
WLS9U3	US3	19.00		
WLS9U5	US5	21.10		
WLS9U10B	US10B	21.10		
WLS9U14	US14	21.10		
WLS9U15	US15	21.10		
WLS9U15A	US15A	21.10		
WLS9U19	US19	21.10		
WLS9U26	US26	21.10		
WLS9U26D	US26D	21.10		
WLS9CR003	CR003	24.00		

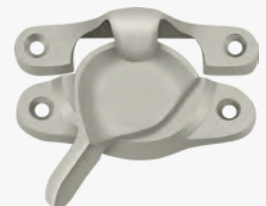

Shutter Door Holders

Transom Catch & Cabinet Locks

1 1/4" / Solid Brass

Part Number	Finish	List Price Each	BOX QTY 35 PC
SDH101U3	US3	6.50	CASE QTY 350 PC
SDH101U5	US5	7.90	
SDH101U10B	US10B	7.90	CASE WEIGHT 42 LB
SDH101U15	US15	7.90	
SDH101U15A	US15A	7.90	
SDH101U19	US19	7.90	
SDH101U26	US26	7.90	
SDH101U26D	US26D	7.90	
SDH101CR003	CR003	9.00	

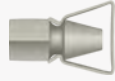

3 1/4" / Solid Brass

Part Number	Finish	List Price Each	BOX QTY 25 PC
SDH103U3	US3	10.00	CASE QTY 240 PC
SDH103U5	US5	12.50	
SDH103U10B	US10B	12.50	CASE WEIGHT 72 LB
SDH103U15	US15	12.50	
SDH103U15A	US15A	12.50	
SDH103U19	US19	12.50	
SDH103U26	US26	12.50	
SDH103U26D	US26D	12.50	
SDH103CR003	CR003	14.40	



2 3/4" / Solid Brass

Part Number	Finish	List Price Each	BOX QTY 10 PC
SDH193U3	US3	11.70	CASE QTY 100 PC
SDH193U5	US5	13.00	
SDH193U10B	US10B	13.00	CASE WEIGHT 32 LB
SDH193U15	US15	13.00	
SDH193U15A	US15A	13.00	
SDH193U19	US19	13.00	
SDH193U26	US26	13.00	
SDH193U26D	US26D	13.00	
SDH193CR003	CR003	16.00	

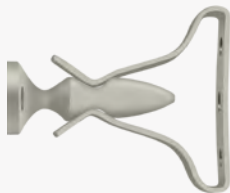

Transom Catch / Solid Brass

Part Number	Finish	List Price Each	BOX QTY 10 PC
TC80U3	US3	40.00	CASE QTY 100 PC
TC80U5	US5	48.00	
TC80U10B	US10B	48.00	
TC80U15	US15	48.00	
TC80U15A	US15A	48.00	
TC80U19	US19	48.00	
TC80U26	US26	48.00	
TC80U26D	US26D	48.00	



1 1/2"x 1 3/4" / Cabinet Lock / Solid Brass

Part Number	Finish	List Price Each	BOX QTY 20 PC
CL1532U3	US3	19.50	CASE QTY 200 PC
CL1532U5	US5	21.80	
CL1532U10B	US10B	21.80	
CL1532U14	US14	21.80	
CL1532U15	US15	21.80	
CL1532U15A	US15A	21.80	
CL1532U26	US26	21.80	
CL1532U26D	US26D	21.80	
CL1532CR003	CR003	25.00	



1 5/8"x 2 1/4" / Cabinet Lock / Solid Brass

Part Number	Finish	List Price Each	BOX QTY 10 PC
CL1580U3	US3	28.00	CASE QTY 100 PC
CL1580U5	US5	32.00	
CL1580U10B	US10B	32.00	
CL1580U14	US14	32.00	
CL1580U15	US15	32.00	
CL1580U15A	US15A	32.00	
CL1580U26	US26	32.00	
CL1580U26D	US26D	32.00	
CL1580CR003	CR003	35.00	



Sliding Door & Window Pin / Steel

Window / Sliding Glass Door Pin

Part Number	Finish	List Price Each	BOX QTY 20 PC
WDP30U10B	US10B	5.00	CASE QTY 360 PC
WDP30U15	US15	5.00	
WDP30CR003	CR003	5.00	

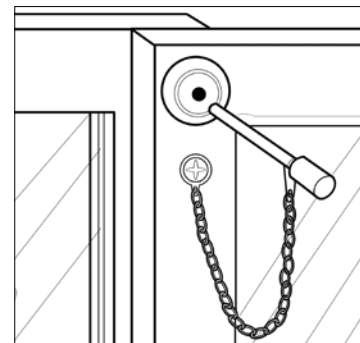

Bathroom Accessories

	Pages
55D: Modern Series	11 - 2
BBS: Modern Series	11 - 3
88: Contemporary Series	11 - 4
R: Traditional Series	11 - 6
ZA: Modern Value Series	11 - 7
BBN: Modern Value Series	11 - 8
Stainless Steel Grab Bars	11 - 9
Grab Bars From 88 Series	11 - 10
HD Shower Shelves	11 - 11
Rectangular Wire Baskets	11 - 12
Corner Wire Baskets	11 - 13
Wire Basket Hook	11 - 13

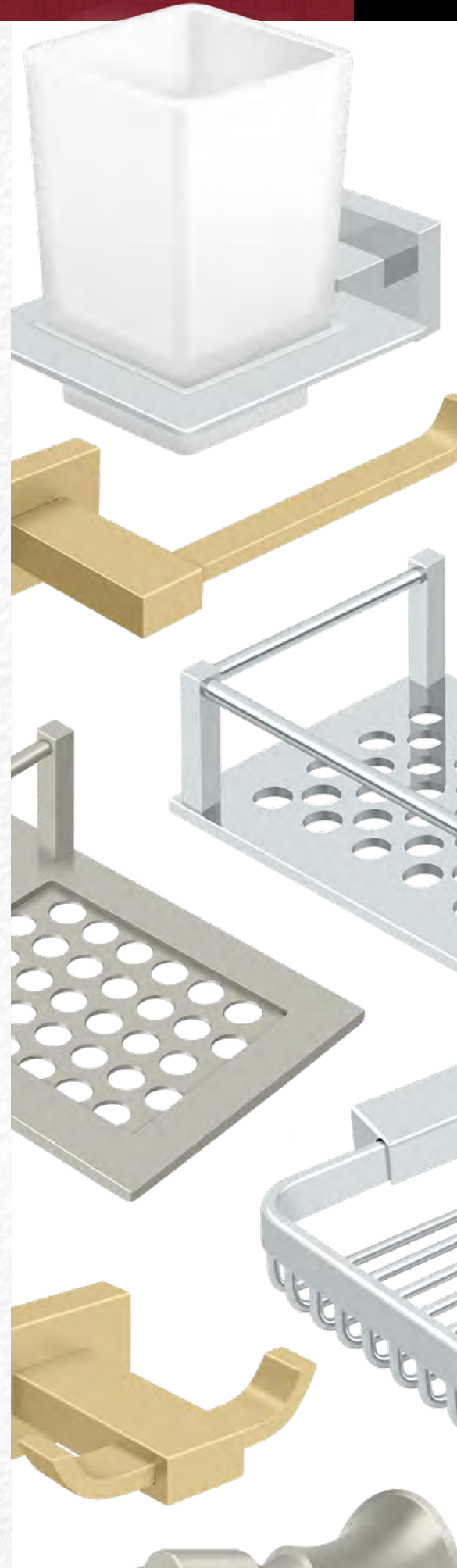

 Custom finish plating available.

BATHROOM ACCESSORIES



55D: Modern Series / Solid Brass

Toilet Paper Holder Single Post

Part Number	Finish	List Each
55D2001-4	US4	55.00
55D2001-14	US14	55.00
55D2001-15	US15	55.00
55D2001-26	US26	55.00

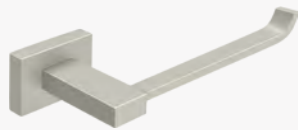
18" Towel Bar

Part Number	Finish	List Each
55D2002/18-4	US4	78.00
55D2002/18-14	US14	78.00
55D2002/18-15	US15	78.00
55D2002/18-26	US26	78.00

24" Towel Bar

Part Number	Finish	List Each
55D2003/24-4	US4	85.00
55D2003/24-14	US14	85.00
55D2003/24-15	US15	85.00
55D2003/24-26	US26	85.00

24" Double Towel Bar

Part Number	Finish	List Each
55D2006-4	US4	125.00
55D2006-14	US14	125.00
55D2006-15	US15	125.00
55D2006-26	US26	125.00

22" Glass Shelf

Part Number	Finish	List Each
55D2015-4	US4	95.00
55D2015-14	US14	95.00
55D2015-15	US15	95.00
55D2015-26	US26	95.00

6" Towel Bar

Part Number	Finish	List Each
55D2008-4	US4	50.00
55D2008-14	US14	50.00
55D2008-15	US15	50.00
55D2008-26	US26	50.00

Double Robe Hook

Part Number	Finish	List Each
55D2010-4	US4	38.00
55D2010-14	US14	38.00
55D2010-15	US15	38.00
55D2010-26	US26	38.00

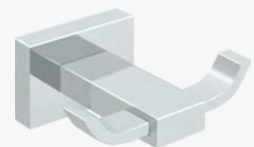
Frosted Glass Soap Dish

Part Number	Finish	List Each
55D2012-4	US4	59.00
55D2012-14	US14	59.00
55D2012-15	US15	59.00
55D2012-26	US26	59.00

Frosted Glass Tumbler Set

Part Number	Finish	List Each
55D2014-4	US4	59.00
55D2014-14	US14	59.00
55D2014-15	US15	59.00
55D2014-26	US26	59.00

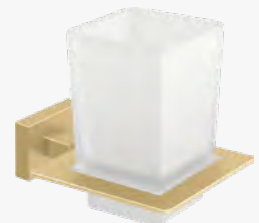

BBS: Modern Series / Solid Brass
Toilet Paper Holder Single Post

Part Number	Finish	List Each
BBS2001-10B	US10B	57.00
BBS2001-14	US14	57.00
BBS2001-15	US15	57.00
BBS2001-26	US26	57.00

Toilet Paper Holder Single Post "L"

Part Number	Finish	List Each
BBS2001L-10B	US10B	74.00
BBS2001L-14	US14	74.00
BBS2001L-15	US15	74.00
BBS2001L-26	US26	74.00

12" Towel Bar

Part Number	Finish	List Each
BBS2003/12-10B	US10B	85.00
BBS2003/12-14	US14	85.00
BBS2003/12-15	US15	85.00
BBS2003/12-26	US26	85.00

18" Towel Bar

Part Number	Finish	List Each
BBS2002/18-10B	US10B	102.00
BBS2002/18-14	US14	102.00
BBS2002/18-15	US15	102.00
BBS2002/18-26	US26	102.00

24" Towel Bar

Part Number	Finish	List Each
BBS2003/24-10B	US10B	112.00
BBS2003/24-14	US14	112.00
BBS2003/24-15	US15	112.00
BBS2003/24-26	US26	112.00

30" Towel Bar

Part Number	Finish	List Each
BBS2004/30-10B	US10B	129.00
BBS2004/30-14	US14	129.00
BBS2004/30-15	US15	129.00
BBS2004/30-26	US26	129.00

24" Double Towel Bar

Part Number	Finish	List Each
BBS2006/24-10B	US10B	142.00
BBS2006/24-14	US14	142.00
BBS2006/24-15	US15	142.00
BBS2006/24-26	US26	142.00

6" Towel Ring

Part Number	Finish	List Each
BBS2008-10B	US10B	68.00
BBS2008-14	US14	68.00
BBS2008-15	US15	68.00
BBS2008-26	US26	68.00

Frosted Glass Soap Dish

Part Number	Finish	List Each
BBS2012-10B	US10B	52.00
BBS2012-14	US14	52.00
BBS2012-15	US15	52.00
BBS2012-26	US26	52.00

Tumbler Holder

Part Number	Finish	List Each
BBS2014-10B	US10B	52.00
BBS2014-14	US14	52.00
BBS2014-15	US15	52.00
BBS2014-26	US26	52.00

Single Robe Hook

Part Number	Finish	List Each
BBS2009-10B	US10B	28.00
BBS2009-14	US14	28.00
BBS2009-15	US15	28.00
BBS2009-26	US26	28.00

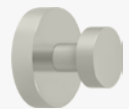
Double Robe Hook

Part Number	Finish	List Each
BBS2010-10B	US10B	45.00
BBS2010-14	US14	45.00
BBS2010-15	US15	45.00
BBS2010-26	US26	45.00



BBS: Modern Series / Solid Brass
12" Shelf

Part Number	Finish	List Each
BBS2018-10B	US10B	173.00
BBS2018-14	US14	173.00
BBS2018-15	US15	173.00
BBS2018-26	US26	173.00

15 3/4" Frosted Glass Shelf

Part Number	Finish	List Each
BBS1575-10B	US10B	102.00
BBS1575-14	US14	102.00
BBS1575-15	US15	102.00
BBS1575-26	US26	102.00

18" Shelf

Part Number	Finish	List Each
BBS2019-10B	US10B	208.00
BBS2019-15	US15	208.00
BBS2019-26	US26	208.00

27 1/2" Frosted Glass Shelf

Part Number	Finish	List Each
BBS2750-10B	US10B	113.00
BBS2750-15	US15	113.00
BBS2750-26	US26	113.00

88: Contemporary Series / Solid Brass
Toilet Paper Holder Single Post

Part Number	Finish	List Each
88STPH-15	US15	68.00
88STPH-26	US26	68.00

12" Towel Bar

Part Number	Finish	List Each
88TB12-15	US15	104.00
88TB12-26	US26	104.00

Toilet Paper Holder Double Post

Part Number	Finish	List Each
88DTPH-15	US15	77.00
88DTPH-26	US26	77.00

18" Towel Bar

Part Number	Finish	List Each
88TB18-15	US15	112.00
88TB18-26	US26	112.00

Single Robe Hook

Part Number	Finish	List Each
88SRH-15	US15	46.00
88SRH-26	US26	46.00

24" Towel Bar

Part Number	Finish	List Each
88TB24-15	US15	127.00
88TB24-26	US26	127.00

Double Robe Hook

Part Number	Finish	List Each
88DRH-15	US15	53.00
88DRH-26	US26	53.00

6" Towel Ring

Part Number	Finish	List Each
88TR6-15	US15	74.00
88TR6-26	US26	74.00



88: Contemporary Series / Solid Brass
Frosted Glass Soap Dish

Part Number	Finish	List Price Each
88SD-15	US15	74.00
88SD-26	US26	74.00

13"x 9" Magazine Rack

Part Number	Finish	List Price Each
88MR-15	US15	162.00
88MR-26	US26	162.00

18" Grab Bar

Part Number	Finish	List Price Each
88GB18-10B	US10B	165.00
88GB18-15	US15	158.00
88GB18-26	US26	158.00

24" Grab Bar

Part Number	Finish	List Price Each
88GB24-10B	US10B	186.00
88GB24-15	US15	176.00
88GB24-26	US26	176.00

20" Hotel Shelf

Part Number	Finish	List Price Each
88HS20-15	US15	236.00
88HS20-26	US26	236.00

24" Hotel Shelf

Part Number	Finish	List Price Each
88HS24-15	US15	276.00
88HS24-26	US26	276.00

32" Grab Bar

Part Number	Finish	List Price Each
88GB32-15	US15	204.00
88GB32-26	US26	204.00

36" Grab Bar with Center Post

Part Number	Finish	List Price Each
88GB36-10B	US10B	289.00
88GB36-15	US15	270.00
88GB36-26	US26	270.00

42" Grab Bar with Center Post

Part Number	Finish	List Price Each
88GB42-15	US15	285.00
88GB42-26	US26	285.00



R: Traditional Series / Solid Brass
Toilet Paper Holder Double Post

Part Number	Finish	List Price Each
R2000-U10B	US10B	76.00
R2000-U14	US14	76.00
R2000-U15	US15	76.00
R2000-U15A	US15A	76.00
R2000-U19	US19	76.00
R2000-U26	US26	76.00
R2000-U26/3	US26/3	76.00
R2000-CR003	CR003	81.00

Toilet Paper Holder Single Post

Part Number	Finish	List Price Each
R2001-U10B	US10B	48.00
R2001-U14	US14	48.00
R2001-U15	US15	48.00
R2001-U15A	US15A	48.00
R2001-U19	US19	48.00
R2001-U26	US26	48.00
R2001-U26/3	US26/3	48.00
R2001-CR003	CR003	53.00

18" Towel Bar

Part Number	Finish	List Price Each
R2002-U10B	US10B	84.00
R2002-U14	US14	84.00
R2002-U15	US15	84.00
R2002-U15A	US15A	84.00
R2002-U19	US19	84.00
R2002-U26	US26	84.00
R2002-U26/3	US26/3	84.00
R2002-CR003	CR003	89.00

24" Towel Bar

Part Number	Finish	List Price Each
R2003-U10B	US10B	94.00
R2003-U14	US14	94.00
R2003-U15	US15	94.00
R2003-U15A	US15A	94.00
R2003-U19	US19	94.00
R2003-U26	US26	94.00
R2003-U26/3	US26/3	94.00
R2003-CR003	CR003	99.00

30" Towel Bar

Part Number	Finish	List Price Each
R2004-U10B	US10B	105.00
R2004-U14	US14	105.00
R2004-U15	US15	105.00
R2004-U15A	US15A	105.00
R2004-U19	US19	105.00
R2004-U26	US26	105.00
R2004-U26/3	US26/3	105.00
R2004-CR003	CR003	111.00

24" Double Towel Bar

Part Number	Finish	List Price Each
R2006-U10B	US10B	170.00
R2006-U14	US14	170.00
R2006-U15	US15	170.00
R2006-U15A	US15A	170.00
R2006-U19	US19	170.00
R2006-U26	US26	170.00
R2006-U26/3	US26/3	170.00
R2006-CR003	CR003	176.00

6" Towel Ring

Part Number	Finish	List Price Each
R2008-U10B	US10B	58.00
R2008-U14	US14	58.00
R2008-U15	US15	58.00
R2008-U15A	US15A	58.00
R2008-U19	US19	58.00
R2008-U26	US26	58.00
R2008-U26/3	US26/3	58.00
R2008-CR003	CR003	62.00

Glass Soap Dish

Part Number	Finish	List Price Each
R2012-U10B	US10B	54.00
R2012-U14	US14	54.00
R2012-U15	US15	54.00
R2012-U15A	US15A	54.00
R2012-U19	US19	54.00
R2012-U26	US26	54.00
R2012-U26/3	US26/3	54.00
R2012 -CR003	CR003	59.00

Frosted Glass Tumbler Set

Part Number	Finish	List Price Each
R2013-U10B	US10B	54.00
R2013-U14	US14	54.00
R2013-U15	US15	54.00
R2013-U15A	US15A	54.00
R2013-U19	US19	54.00
R2013-U26	US26	54.00
R2013-U26/3	US26/3	54.00
R2013 -CR003	CR003	59.00

Clear Glass 18" Shelf

Part Number	Finish	List Price Each
R2015-U10B	US10B	82.00
R2015-U14	US14	82.00
R2015-U15	US15	82.00
R2015-U15A	US15A	82.00
R2015-U19	US19	82.00
R2015-U26	US26	82.00
R2015-U26/3	US26/3	82.00
R2015 -CR003	CR003	88.00



R: Traditional Series / Solid Brass
Single Robe Hook

Part Number	Finish	List Price Each
R2009-U10B	US10B	30.00
R2009-U14	US14	30.00
R2009-U15	US15	30.00
R2009-U15A	US15A	30.00
R2009-U19	US19	30.00
R2009-U26	US26	30.00
R2009-U26/3	US26/3	30.00
R2009-CR003	CR003	34.00

Double Robe Hook

Part Number	Finish	List Price Each
R2010-U10B	US10B	44.00
R2010-U14	US14	44.00
R2010-U15	US15	44.00
R2010-U15A	US15A	44.00
R2010-U19	US19	44.00
R2010-U26	US26	44.00
R2010-U26/3	US26/3	44.00
R2010-CR003	CR003	48.00

ZA: Modern Value Series / Zinc & Aluminum
Toilet Paper Holder Single Post

Part Number	Finish	List Price Each
ZA2001-15	US15	22.00
ZA2001-26	US26	22.00

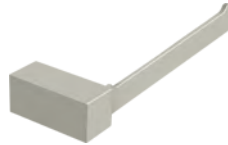
Frosted Glass Tumbler Set

Part Number	Finish	List Price Each
ZA2014-15	US15	25.00
ZA2014-26	US26	25.00

8" Towel Ring

Part Number	Finish	List Price Each
ZA2008-15	US15	27.00
ZA2008-26	US26	27.00

Frosted Glass Soap Dish

Part Number	Finish	List Price Each
ZA2012-15	US15	25.00
ZA2012-26	US26	25.00

Single Robe Hook

Part Number	Finish	List Price Each
ZA2009-15	US15	14.00
ZA2009-26	US26	14.00

24" Hotel Shelf

Part Number	Finish	List Price Each
ZA2024-15	US15	150.00
ZA2024-26	US26	150.00

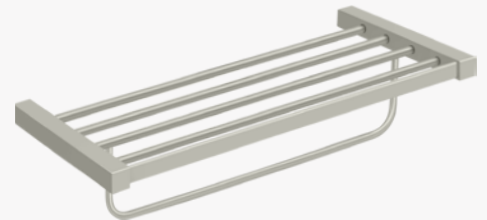
Double Robe Hook

Part Number	Finish	List Price Each
ZA2010-15	US15	17.00
ZA2010-26	US26	17.00



ZA: Modern Value Series / Zinc & Aluminum
18" Towel Bar

Part Number	Finish	List Price Each
ZA2002/18-15	US15	46.00
ZA2002/18-26	US26	46.00

30" Towel Bar

Part Number	Finish	List Price Each
ZA2004/30-15	US15	57.00
ZA2004/30-26	US26	57.00

24" Towel Bar

Part Number	Finish	List Price Each
ZA2003/24-15	US15	50.00
ZA2003/24-26	US26	50.00

24" Double Towel Bar

Part Number	Finish	List Price Each
ZA2006/24-15	US15	78.00
ZA2006/24-26	US26	78.00

BBN: Modern Value Series / Zinc
Toilet Paper Holder Single Post

Part Number	Finish	List Price Each
BBN2001-15	US15	23.00
BBN2001-26	US26	23.00

Frosted Glass Tumbler Set

Part Number	Finish	List Price Each
BBN2014-15	US15	21.00
BBN2014-26	US26	21.00

Toilet Paper Holder Single Post w/ Cover

Part Number	Finish	List Price Each
BBN2011-15	US15	32.00
BBN2011-26	US26	32.00

12" Towel Bar

Part Number	Finish	List Price Each
BBN2003/12-15	US15	42.00
BBN2003/12-26	US26	42.00

6" Towel Ring

Part Number	Finish	List Price Each
BBN2008-15	US15	29.00
BBN2008-26	US26	29.00

18" Towel Bar

Part Number	Finish	List Price Each
BBN2002/18-15	US15	50.00
BBN2002/18-26	US26	50.00

Frosted Glass Soap Dish

Part Number	Finish	List Price Each
BBN2012-15	US15	21.00
BBN2012-26	US26	21.00

24" Towel Bar

Part Number	Finish	List Price Each
BBN2003/24-15	US15	54.00
BBN2003/24-26	US26	54.00



BBN: Modern Value Series / Zinc & Aluminum
30" Towel Bar

Part Number	Finish	List Price Each
BBN2004/30-15	US15	62.00
BBN2004/30-26	US26	62.00

24" Double Towel Bar

Part Number	Finish	List Price Each
BBN2006/24-15	US15	87.00
BBN2006/24-26	US26	87.00

20" Clear Glass Shelf

Part Number	Finish	List Price Each
BBN2015/20-15	US15	54.00
BBN2015/20-26	US26	54.00

Single Robe Hook

Part Number	Finish	List Price Each
BBN2009-15	US15	17.00
BBN2009-26	US26	17.00

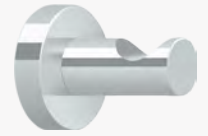
Double Robe Hook

Part Number	Finish	List Price Each
BBN2010-15	US15	20.00
BBN2010-26	US26	20.00

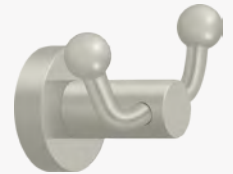
Grab Bars / Stainless Steel / US32D

Part Number	Lengths	List Price Each
GB18U32D	18"	48.00
GB24U32D	24"	55.00
GB30U32D	30"	59.00
GB36U32D	36"	64.00



- 1 1/2" Bar Diameter
- Inside Projection: 2"
- Concealed Screw Installation

Grab Bars / Stainless Steel

Part Number	Lengths	List Price Each
GB42U32D	42"	70.00
GB42CPU32D	42" with Center Post	88.00

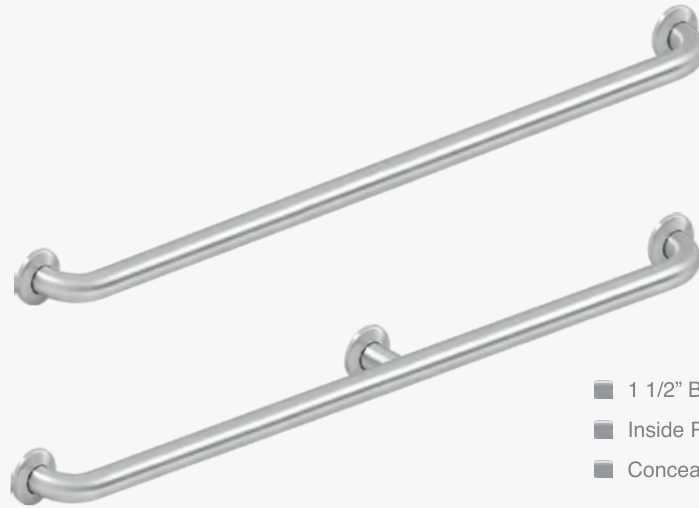

- 1 1/2" Bar Diameter
- Inside Projection: 2"
- Concealed Screw Installation

Grab Bars from 88 Series / Solid Brass
18" Grab Bar

Part Number	Finish	List Price Each
88GB18-10B	US10B	165.00
88GB18-15	US15	158.00
88GB18-26	US26	158.00

24" Grab Bar

Part Number	Finish	List Price Each
88GB24-10B	US10B	186.00
88GB24-15	US15	176.00
88GB24-26	US26	176.00

32" Grab Bar

Part Number	Finish	List Price Each
88GB32-15	US15	204.00
88GB32-26	US26	204.00

36" Grab Bar with Center Post

Part Number	Finish	List Price Each
88GB36-10B	US10B	289.00
88GB36-15	US15	270.00
88GB36-26	US26	270.00

42" Grab Bar with Center Post

Part Number	Finish	List Price Each
88GB42-15	US15	285.00
88GB42-26	US26	285.00



- 1 1/2" Bar Diameter
- Inside Projection: 2 1/2"
- Concealed Screw Installation

Bathroom Shower Shelves / Solid Brass

Corner Left 9"

Part Number	Finish	List Price Each
WBHDCL9U15	US15	250.00
WBHDCL9U26	US26	250.00

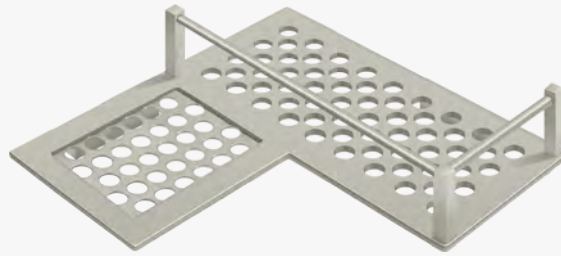
Corner Right 9"

Part Number	Finish	List Price Each
WBHDCR9U15	US15	250.00
WBHDCR9U26	US26	250.00

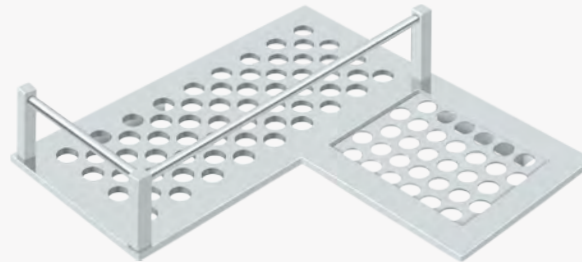
Universal Corner 9"

Part Number	Finish	List Price Each
WBHDUC9U15	US15	268.00
WBHDUC9U26	US26	268.00

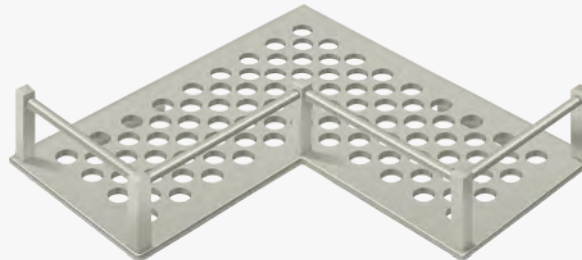
Rectangular 12 1/4"

Part Number	Finish	List Price Each
WBHD12RU15	US15	300.00
WBHD12RU26	US26	300.00

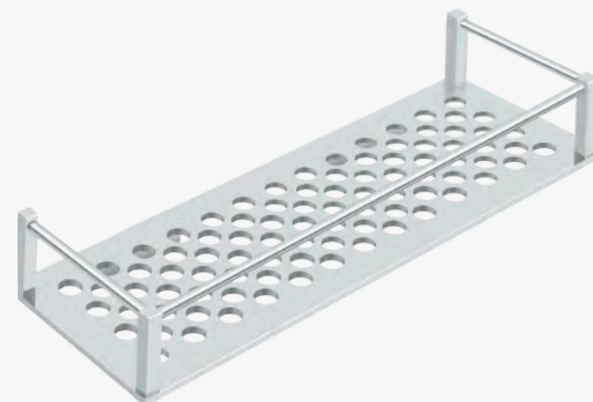
Soap Dish 5 1/2"

Part Number	Finish	List Price Each
WBHSD55U15	US15	100.00
WBHSD55U26	US26	100.00

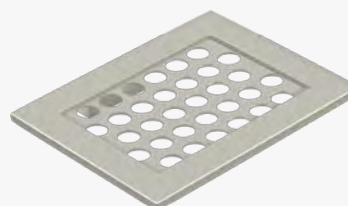

Wire Baskets / Solid Brass
4 3/4" Soap Holder

Part Number	Finish	List Price Each
WBR4535U15	US15	56.00
WBR4535U26	US26	56.00
WBR4535CR003	CR003	56.00

6" Soap Holder

Part Number	Finish	List Price Each
WBR6050U15	US15	58.00
WBR6050U26	US26	58.00
WBR6050CR003	CR003	58.00

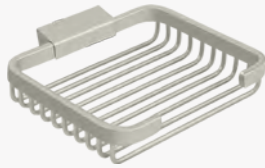
8" Soap Holder

Part Number	Finish	List Price Each
WBR8040U10B	US10B	70.00
WBR8040U14	US14	70.00
WBR8040U15	US15	70.00
WBR8040U26	US26	70.00
WBR8040CR003	CR003	70.00

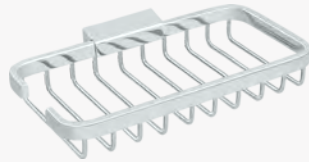
10 3/8" Deep Wire Basket w/ Hook

Part Number	Finish	List Price Each
WBR1054HU14	US14	96.00
WBR1054HU15	US15	96.00
WBR1054HU26	US26	96.00
WBR1054HCR003	CR003	96.00

10 3/8" Wire Basket w/ Hook

Part Number	Finish	List Price Each
WBR1052HU14	US14	84.00
WBR1052HU15	US15	84.00
WBR1052HU26	US26	84.00
WBR1052HCR003	CR003	84.00

10 3/8" Combo Wire Basket with Hook

Part Number	Finish	List Price Each
WBR1051HU10B	US10B	84.00
WBR1051HU14	US14	84.00
WBR1051HU15	US15	84.00
WBR1051HU26	US26	84.00
WBR1051HCR003	CR003	84.00

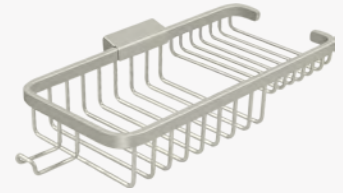
17 3/8" Combo Wire Basket with Hook

Part Number	Finish	List Price Each
WBR1850HU14	US14	152.00
WBR1850HU15	US15	152.00
WBR1850HU26	US26	152.00
WBR1850HCR003	CR003	152.00

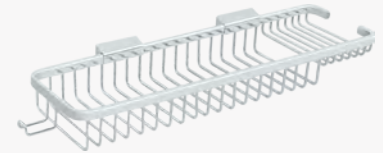
18" Combo Wire Basket

Part Number	Finish	List Price Each
WBR1835U14	US14	152.00
WBR1835U15	US15	152.00
WBR1835U26	US26	152.00
WBR1835CR003	CR003	152.00

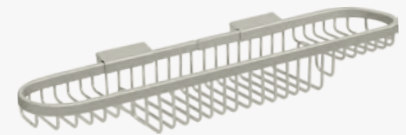
18" Wire Basket

Part Number	Finish	List Price Each
WBR1851U15	US15	151.00
WBR1851U26	US26	151.00
WBR1851CR003	CR003	151.00

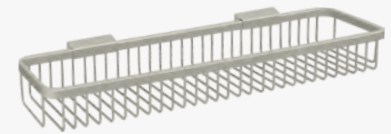
28" Wire Basket

Part Number	Finish	List Price Each
WBR2847U15	US15	167.00
WBR2847U26	US26	167.00

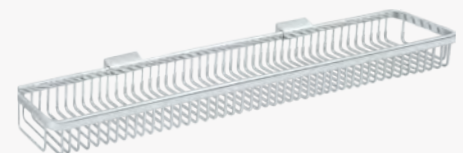

Corner Wire Baskets / Solid Brass
Pentagon 6 3/4" x 5 1/4"

Part Number	Finish	List Price Each
WBP542U26	US26	55.00

Triangular 8 3/4" x 6 7/8" x 2"

Part Number	Finish	List Price Each
WBC8570U10B	US10B	70.00
WBC8570U14	US14	70.00
WBC8570U15	US15	70.00
WBC8570U26	US26	70.00
WBC8570CR003	CR003	70.00

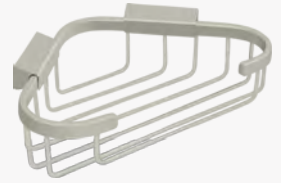
Pentagon 8 1/4" x 6 7/8"

Part Number	Finish	List Price Each
WBC6353U15	US15	70.00
WBC6353U26	US26	70.00
WBC6353CR003	CR003	70.00

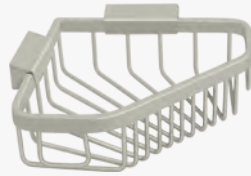
Triangular 13 1/4" x 10 1/4" x 3 1/2"

Part Number	Finish	List Price Each
WBC1310U10B	US10B	100.00
WBC1310U14	US14	100.00
WBC1310U15	US15	100.00
WBC1310U26	US26	100.00
WBC1310CR003	CR003	100.00

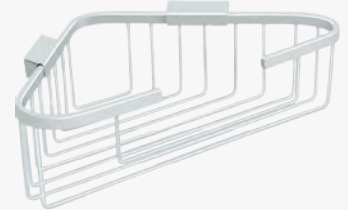
Triangular 6" x 5"

Part Number	Finish	List Price Each
WBC6050U15	US15	64.00
WBC6050U26	US26	64.00
WBC6050UCR003	CR003	64.00

Wire Basket Hook / For use with Deltana Wire Baskets / Solid Brass
Wire Basket Hook / 1 1/4" x 1 3/4"

Part Number	Finish	List Price Each
WBHOOK-10B	US10B	21.00
WBHOOK-15	US15	21.00
WBHOOK-26	US26	21.00
WBHOOK-CR003	CR003	24.00

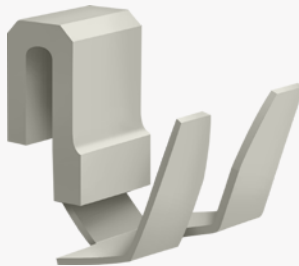

Projection : 1 7/8"

Miscellaneous: Strikes, Screws & Accessories

	Pages
Extended Strike Plates	12 - 2
Strike Plates for Ball and Roller Catches	12 - 2
Strikes for Surface Bolts	12 - 2
Strikes for Catches	12 - 3
Strikes for Commercial Locks	12 - 3
Adjustable Dust-Proof Strikes	12 - 3
Cabin Hook Eyes	12 - 3
Corner Chisels for Square Hinge Intallation	12 - 4
Flushbolt Strikes	12 - 4
Button Tip Finial	12 - 4
Dust Cup, Deadbolt & Latch Strikes	12 - 4
Extra Extension Rods for Extension Flush Bolts	12 - 4
Steel Screws	12 - 5
Solid Brass Screws	12 - 6
Replacements Rubber Bumper Bands	12 - 7
Screen and Storm Door Latch Accessories	12 - 7
Surface Bolt Accessories	12 - 8
Pins for Steel Residential Hinges	12 - 8
Barrel Pins For Solid Brass Hinges	12 - 8
Screw Covers	12 - 8
Replacement Bell Button Mechanism	12 - 8
The Deltana Gambit	12 - 8



 Custom finish plating available.

Extended Lip Strike Plates / Solid Brass

Extended T-Strike Plates / Solid Brass

2 1/4"x 2"

Part Number	Finish	List Price Each	BOX QTY	LIP EXTENDS
SPE200U3	US3	6.10	50 PC	1 1/2"
SPE200U10B	US10B	6.10		
SPE200U14	US14	6.10		
SPE200U15	US15	6.10		
SPE200U26	US26	6.10		
SPE200U26D	US26D	6.10		



2"

Part Number	Finish	List Price Each	BOX QTY	LIP EXTENDS
TSPE200U3	US3	6.10	40 PC	1 1/2"
TSPE200U10B	US10B	6.10		
TSPE200U15	US15	6.10		



2 1/4"x 2 1/4"

Part Number	Finish	List Price Each	BOX QTY	LIP EXTENDS
SPE225U3	US3	6.90	40 PC	1 3/4"
SPE225U10B	US10B	6.90		
SPE225U14	US14	6.90		
SPE225U15	US15	6.90		
SPE225U26	US26	6.90		
SPE225U26D	US26D	6.90		



2 1/4"

Part Number	Finish	List Price Each	BOX QTY	LIP EXTENDS
TSPE225U3	US3	6.50	30 PC	1 3/4"
TSPE225U10B	US10B	6.50		
TSPE225U14	US14	6.50		
TSPE225U15	US15	6.50		
TSPE225U26	US26	6.50		
TSPE225U26D	US26D	6.50		



2 1/4"x 2 1/2"

Part Number	Finish	List Price Each	BOX QTY	LIP EXTENDS
SPE250U3	US3	7.40	40 PC	2"
SPE250U10B	US10B	7.40		
SPE250U14	US14	7.40		
SPE250U15	US15	7.40		
SPE250U26	US26	7.40		
SPE250U26D	US26D	7.40		



2 1/2"

Part Number	Finish	List Price Each	BOX QTY	LIP EXTENDS
TSPE250U3	US3	7.40	30 PC	2"
TSPE250U10B	US10B	7.40		
TSPE250U15	US15	7.40		



Strike Plates for use with Ball Catches and Roller Latches / Solid Brass

2 1/8"x 1 3/8"

Part Number	Finish	List Price Each
SPB349U3	US3	2.90
SPB349U5	US5	3.20
SPB349U10B	US10B	3.20
SPB349U15	US15	3.20
SPB349U15A	US15A	3.20
SPB349U19	US19	3.20
SPB349U26	US26	3.20
SPB349U26D	US26D	3.20
SPB349CR003	CR003	3.60



Full Lip 2 1/4"x 1 5/8"

Part Number	Finish	List Price Each	LIP EXTENDS
FLSP335U3	US3	4.20	2"
FLSP335U5	US5	4.80	
FLSP335U10B	US10B	4.80	
FLSP335U15	US15	4.80	
FLSP335U15A	US15A	4.80	
FLSP335U19	US19	4.80	
FLSP335U26	US26	4.80	
FLSP335U26D	US26D	4.80	
FLSP335CR003	CR003	5.50	



Strikes for Surface Bolts / Solid Brass

1 7/8"x 1 1/8" Angle Strike

Part Number	Finish	List Price Each
178ASTU3	US3	5.50
178ASTU5	US5	5.88
178ASTU10B	US10B	5.88
178ASTU15	US15	5.88
178ASTU15A	US15A	5.88
178ASTU19	US19	5.88
178ASTU26	US26	5.88
178ASTU26D	US26D	5.88
178ASTCR003	CR003	6.00

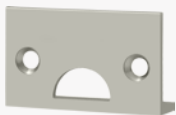

1 7/8" x 1 1/16" Mortise Strike

Part Number	Finish	List Price Each
178MSTU3	US3	5.50
178MSTU5	US5	5.88
178MSTU10B	US10B	5.88
178MSTU15	US15	5.88
178MSTU15A	US15A	5.88
178MSTU19	US19	5.88
178MSTU26	US26	5.88
178MSTU26D	US26D	5.88
178MSTCR003	CR003	6.00



1 7/8"x 1 1/2" Universal Strike

Part Number	Finish	List Price Each
178USTU3	US3	5.50
178USTU5	US5	5.88
178USTU10B	US10B	5.88
178USTU15	US15	5.88
178USTU15A	US15A	5.88
178USTU19	US19	5.88
178USTU26	US26	5.88
178USTU26D	US26D	5.88
178USTCR003	CR003	6.00



Strikes for Catches / Solid Brass

Strikes for Commercial Locks / Solid Brass

2 3/4" x 1 3/4"

Part Number	Finish	List Each
TSRCA275U3	US3	6.40
TSRCA275U5	US5	6.90
TSRCA275U10B	US10B	6.90
TSRCA275U15	US15	6.90
TSRCA275U15A	US15A	6.90
TSRCA275U26	US26	6.90
TSRCA275U26D	US26D	6.90
TSRCA275CR003	CR003	7.40



2 3/4" x 1 3/4"

Part Number	Finish	List Each
SPTS275U3	US3	6.00
SPTS275U26D	US26D	6.00



4 7/8" x 1 7/8"

Part Number	Finish	List Each
TSRCA4875U3	US3	10.20
TSRCA4875U5	US5	11.00
TSRCA4875U10B	US10B	11.00
TSRCA4875U15	US15	11.00
TSRCA4875U15A	US15A	11.00
TSRCA4875U26	US26	11.00
TSRCA4875U26D	US26D	11.00
TSRCA4875CR003	CR003	11.60



ANSI Strike 4 7/8" x 1 1/4"

Part Number	Finish	List Each
SPDB478U3	US3	11.50
SPDB478U5	US5	11.50
SPDB478U10B	US10B	11.50
SPDB478U15	US15	11.50
SPDB478U15A	US15A	11.50
SPDB478U26	US26	11.50
SPDB478U26D	US26D	11.50
SPDB478CR003	CR003	13.00



2 1/8" x 1 5/8" / Heavy Duty / Full Lip

Part Number	Finish	List Each
SPRCA430U3	US3	8.80
SPRCA430U5	US5	10.00
SPRCA430U10B	US10B	10.00
SPRCA430U15	US15	10.00
SPRCA430U15A	US15A	10.00
SPRCA430U19	US19	10.00
SPRCA430U26	US26	10.00
SPRCA430U26D	US26D	10.00
SPRCA430CR003	CR003	10.50



ANSI Blank Strike 4 7/8" x 1 1/4"

Part Number	Finish	List Each
SPBDB478U3	US3	11.50
SPBDB478U5	US5	11.50
SPBDB478U10B	US10B	11.50
SPBDB478U15	US15	11.50
SPBDB478U15A	US15A	11.50
SPBDB478U26	US26	11.50
SPBDB478U26D	US26D	11.50
SPBDB478CR003	CR003	13.00



Dust-Proof Strikes / Solid Brass

2 7/8" x 1 3/8" Plate / Adjustable Height

Part Number	Finish	List Each	BOX QTY
SPDP278U3	US3	20.80	10 PC
SPDP278U5	US5	22.80	
SPDP278U10B	US10B	22.80	
SPDP278U15	US15	22.80	
SPDP278U15A	US15A	22.80	
SPDP278U26	US26	22.80	
SPDP278U26D	US26D	22.80	
SPDP278CR003	CR003	24.80	

CASE QTY 100 PC



3 1/2" x 1 5/8" Plate / With Safety Lock

Part Number	Finish	Each	BOX QTY
SPDP35SU3	US3	24.00	10 PC
SPDP35SU5	US5	26.00	
SPDP35SU10B	US10B	26.00	
SPDP35SU15	US15	26.00	
SPDP35SU15A	US15A	26.00	
SPDP35SU26	US26	26.00	
SPDP35SU26D	US26D	26.00	
SPDP35SCR003	CR003	29.00	

CASE QTY 100 PC



Accessory Eyes for Cabin Hooks / Solid Brass

Cabin Hook Eye for British Style

Part Number	Finish	List Price Each
CHEBU3	US3	5.00
CHEBU5	US5	6.00
CHEBU10B	US10B	6.00
CHEBU15	US15	6.00
CHEBU15A	US15A	6.00
CHEBU19	US19	6.00
CHEBU26	US26	6.00
CHEBU26D	US26D	6.00
CHEBCR003	CR003	7.00



Cabin Hook Eye for Contemporary

Part Number	Finish	List Price Each
CHE4U3	US3	4.50
CHE4U5	US5	5.00
CHE4U10B	US10B	5.00
CHE4U15	US15	5.00
CHE4U15A	US15A	5.00
CHE4U19	US19	5.00
CHE4U26	US26	5.00
CHE4U26D	US26D	5.00
CHE4CR003	CR003	6.00



Strike Plates for Flush Bolts / Solid Brass

Strike Plates / Solid Brass

1 3/4" x 1
For 6" Flush Bolt 6FBS / 6FBR

Part Number	Finish	List Each
SP6FBU3	US3	3.95
SP6FBU5	US5	3.95
SP6FBU10B	US10B	3.95
SP6FBU15	US15	3.95
SP6FBU15A	US15A	3.95
SP6FBU19	US19	3.95
SP6FBU26	US26	3.95
SP6FBU26D	US26D	3.95
SP6FBCR003	CR003	3.95



1 1/2" x 5/8"
For 7FBR Flush Bolt

Part Number	Finish	List Each
SP7FBR3	US3	3.95
SP7FBR5	US5	3.95
SP7FBR10B	US10B	3.95
SP7FBR15	US15	3.95
SP7FBR15A	US15A	3.95
SP7FBR19	US19	3.95
SP7FBR26	US26	3.95
SP7FBR26D	US26D	3.95
SP7FBR003	CR003	3.95



2 1/4" x 1"
For 12EFB Extension Flush Bolt

Part Number	Finish	List Each
SP12EFB3	US3	3.95
SP12EFB5	US5	3.95
SP12EFB10B	US10B	3.95
SP12EFB15	US15	3.95
SP12EFB15A	US15A	3.95
SP12EFB19	US19	3.95
SP12EFB26	US26	3.95
SP12EFB26D	US26D	3.95
SP12EFB003	CR003	3.95



2" x 1" Guide
For 12EFB Extension Flush Bolt

Part Number	Finish	List Each
GP12EFB3	US3	3.95
GP12EFB5	US5	3.95
GP12EFB10B	US10B	3.95
GP12EFB15	US15	3.95
GP12EFB15A	US15A	3.95
GP12EFB19	US19	3.95
GP12EFB26	US26	3.95
GP12EFB26D	US26D	3.95



Dust Cup / Adjustable 2 3/4" x 1 1/4"

Part Number	Finish	List Each	BOX QTY
SP2751U3	US3	4.80	50 PC
SP2751U5	US5	4.80	
SP2751U26	US26	4.80	
SP2751U26D	US26D	4.80	CASE QTY 500 PC

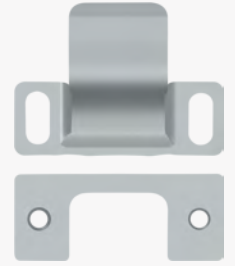

2 3/4" x 1 1/4" / For Deadbolt

Part Number	Finish	List Each	BPX QTY
SP2753U3	US3	3.00	50 PC
SP2753U5	US5	3.00	
SP2753U26	US26	3.00	
SP2753U26D	US26D	3.00	CASE QTY 500 PC



2 1/4" x 1 1/2" / For Latch

Part Number	Finish	List Each	BOX QTY
SP225U3	US3	3.00	50 PC
SP225CR003	CR003	3.00	
SS SP225U32	US32	3.00	CASE QTY 500 PC

SS Stainless Steel



Extra Extension Rods / Steel

Extra Extension Rods

Part Number	Length	List Price Each
18EXTROD	18"	4.00
24EXTROD	24"	4.80
39EXTROD	39"	5.50

Rod threading is 1-3/8" for 18" and 24". 39" is fully threaded.

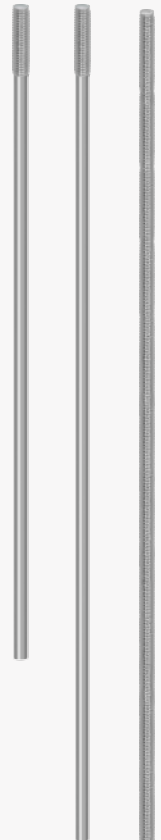

Button Tip Finial / Solid Brass

For Hinges from 3 1/2" x 3 1/2" ~ 5" x 5"

Part Number	Finish	List Each	HEIGHT
DSBU3	US3	3.00	1/8"
DSBU3-UNL	US3-UNL	3.00	
DSBU5	US5	3.00	5/8"
DSBU10B	US10B	3.00	
DSBU14	US14	3.00	
DSBU15	US15	3.00	
DSBU15A	US15A	3.00	
DSBU19	US19	3.00	
DSBU26	US26	3.00	
DSBU26D	US26D	3.00	
DSBUCR003	CR003	3.00	



Corner Chisels

Corner Chisels for Square Hinge Installation

Part Number	Cut Depth	List Each
CC58	5/8"	22.00
CC78	7/8"	25.00



CC58

CC78

Steel Screws
#9 x 3/4" Wood Screw

Part Number	Finish	List Price Each
SCWS975U1B	US1B	0.11
SCWS975U2D	US2D	0.11
SCWS975U3	US3	0.11
SCWS975U4	US4	0.11
SCWS975U5	US5	0.11
SCWS975U10B	US10B	0.11
SCWS975U15	US15	0.11
SCWS975U15A	US15A	0.11
SCWS975U26	US26	0.11
SCWS975U26D	US26D	0.11
SCWS975USP-W	White	0.11

#9 x 1" Wood Screw

Part Number	Finish	List Price Each
SCWS910USPW	White	0.13
SCWS910U2D	US2D	0.13
SCWS910U3	US3	0.13
SCWS910U4	US4	0.13
SCWS910U5	US5	0.13
SCWS910U10B	US10B	0.13
SCWS910U15	US15	0.13
SCWS910U15A	US15A	0.13
SCWS910U26	US26	0.13
SCWS910U26D	US26D	0.13

#9 x 2 1/2" Wood Screw

Part Number	Finish	List Price Each
SCWS925U4	US4	0.20
SCWS925U5	US5	0.20
SCWS925U10B	US10B	0.20
SCWS925U15	US15	0.20
SCWS925U15A	US15A	0.20
SCWS925U26D	US26D	0.20

#10 x 2 1/2" Wood Screw

Part Number	Finish	List Price Each
SCWS1025U3	US3	0.20
SCWS1025U5	US5	0.20
SCWS1025U10B	US10B	0.20
SCWS1025U15	US15	0.20
SCWS1025U15A	US15A	0.20
SCWS1025U26	US26	0.20
SCWS1025U26D	US26D	0.20

#12 x 3/4" Wood Screw

Part Number	Finish	List Price Each
SCWS1275U3	US3	0.14
SCWS1275U5	US5	0.14
SCWS1275U10B	US10B	0.14
SCWS1275U15	US15	0.14
SCWS1275U15A	US15A	0.14
SCWS1275U26	US26	0.14
SCWS1275U26D	US26D	0.14
SCWS1275USPW	White	0.14

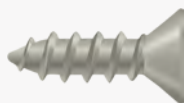
#10 x 3/4" Wood Screw

Part Number	Finish	List Price Each
SCWS1075U2D	US2D	0.12
SCWS1075U3	US3	0.12
SCWS1075U4	US4	0.12
SCWS1075U5	US5	0.12
SCWS1075U10B	US10B	0.12
SCWS1075U15	US15	0.12
SCWS1075U15A	US15A	0.12
SCWS1075U26	US26	0.12
SCWS1075U26D	US26D	0.12
SCWS1075USP-W	White	0.12

#10 x 1" Wood Screw

Part Number	Finish	List Price Each
SCWS1010U2D	US2D	0.13
SCWS1010U3	US3	0.13
SCWS1010U5	US5	0.13
SCWS1010U10B	US10B	0.13
SCWS1010U14	US14	0.13
SCWS1010U15	US15	0.13
SCWS1010U15A	US15A	0.13
SCWS1010U26	US26	0.13
SCWS1010U26D	US26D	0.13
SCWS1010USP	White	0.13

#10 x 2" Wood Screw

Part Number	Finish	List Price Each
SCWST1020U15	US15	0.18

#10 x 2 1/2" Wood Screw / Full Thread

Part Number	Finish	List Price Each
SCWS1025U2D	US2D	0.20
SCWS1025USPW	White	0.20

#12 x 1 1/4" Wood Screw

Part Number	Finish	List Price Each
SCWS12125U1B	US1B	0.15
SCWS12125U3	US3	0.15
SCWS12125U5	US5	0.15
SCWS12125U10B	US10B	0.15
SCWS12125U15	US15	0.15
SCWS12125U15A	US15A	0.15
SCWS12125U26	US26	0.15
SCWS12125U26D	US26D	0.15



Steel Screws

#12 x 1" Wood Screw

Part Number	Finish	List Price Each
SCWS1210U3	US3	0.14
SCWS1210U5	US5	0.14
SCWS1210U10B	US10B	0.14
SCWS1210U15	US15	0.14
SCWS1210U15A	US15A	0.14
SCWS1210U26	US26	0.14
SCWS1210U26D	US26D	0.14
SCWS1210USP	White	0.14



#10 x 1/2" Machine Screw

Part Number	Finish	List Price Each
SCMS1005U2D	US2D	0.11
SCMS1005U3	US3	0.11
SCMS1005U5	US5	0.11
SCMS1005U10B	US10B	0.11
SCMS1005U15	US15	0.11
SCMS1005U15A	US15A	0.11
SCMS1005U26	US26	0.11
SCMS1005U26D	US26D	0.11
SCMS1005USP	White	0.11



#9 x 1/2" Machine Screw

Part Number	Finish	List Price Each
SCMS905USPW	White	0.12
SCMS905U3	US3	0.12
SCMS905U4	US4	0.12
SCMS905U5	US5	0.12
SCMS905U10B	US10B	0.12
SCMS905U15	US15	0.12
SCMS905U26	US26	0.12
SCMS905U26D	US26D	0.12



#12 x 1/2" Machine Screw

Part Number	Finish	List Price Each
SCMS1205U2D	US2D	0.11
SCMS1205U3	US3	0.11
SCMS1205U5	US5	0.11
SCMS1205U10B	US10B	0.11
SCMS1205U15	US15	0.11
SCMS1205U15A	US15A	0.11
SCMS1205U26	US26	0.11
SCMS1205U26D	US26D	0.11
SCMS1205USP	White	0.11

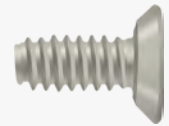

Solid Brass Screws

#7"x 3/4" Wood Screw

Part Number	Finish	List Price Each
SCWB775U3	US3	0.32
SCWB775U5	US5	0.32
SCWB775U10B	US10B	0.32
SCWB775U14	US14	0.32
SCWB775U15	US15	0.32
SCWB775U15A	US15A	0.32
SCWB775U19	US19	0.32
SCWB775U26	US26	0.32
SCWB775U26D	US26D	0.32
SCWB775CR003	CR003	0.32



#10"x 1" Wood Screw

Part Number	Finish	List Price Each
SCWB1010U3-UNL	US3-UNL	0.42
SCWB1010U3	US3	0.42
SCWB1010U4	US4	0.42
SCWB1010U5	US5	0.42
SCWB1010U10B	US10B	0.42
SCWB1010U14	US14	0.42
SCWB1010U15	US15	0.42
SCWB1010U15A	US15A	0.42
SCWB1010U19	US19	0.42
SCWB1010U26	US26	0.42
SCWB1010U26D	US26D	0.42
SCWB1010CR003	CR003	0.42



#12"x 1 1/4" Wood Screw

Part Number	Finish	List Price Each
SCWB12125U3-UNL	US3-UNL	0.50
SCWB12125U3	US3	0.50
SCWB12125U4	US4	0.50
SCWB12125U5	US5	0.50
SCWB12125U10B	US10B	0.50
SCWB12125U14	US14	0.50
SCWB12125U15	US15	0.50
SCWB12125U15A	US15A	0.50
SCWB12125U26	US26	0.50
SCWB12125U26D	US26D	0.50
SCWB12125CR003	CR003	0.50



#10"x 2 1/2" Wood Screw

Part Number	Finish	List Price Each
SCWB1025U3	US3	0.80
SCWB1025U5	US5	0.80
SCWB1025U10B	US10B	0.80
SCWB1025U15	US15	0.80
SCWB1025U15A	US15A	0.80
SCWB1025U19	US19	0.80
SCWB1025U26	US26	0.80
SCWB1025U26D	US26D	0.80
SCWB1025CR003	CR003	0.80



#12"x 2 1/2" Wood Screw

Part Number	Finish	List Price Each
SCWB1225U3	US3	0.80
SCWB1225U5	US5	0.80
SCWB1225U10B	US10B	0.80
SCWB1225U15	US15	0.80
SCWB1225U15A	US15A	0.80
SCWB1225U26	US26	0.80
SCWB1225U26D	US26D	0.80
SCWB1225CR003	CR003	0.80



#14 x 1 1/4" Wood Screw

Part Number	Finish	List Price Each
SCWB14125U3	US3	0.90
SCWB14125U3-UNL	US3-UNL	0.90
SCWB14125U5	US5	0.90
SCWB14125U10B	US10B	0.90
SCWB14125U14	US14	0.90
SCWB14125U15	US15	0.90
SCWB14125U15A	US15A	0.90
SCWB14125U19	US19	0.90
SCWB14125U26	US26	0.90
SCWB14125U26D	US26D	0.90
SCWB14125CR003	CR003	0.90



Solid Brass Machine Screws
#12"x 1/2" Machine Screw

Part Number	Finish	List Price Each
SCMB1205U3-UNL	US3-UNL	0.48
SCMB1205U3	US3	0.48
SCMB1205U5	US5	0.48
SCMB1205U10B	US10B	0.48
SCMB1205U15	US15	0.48
SCMB1205U15A	US15A	0.48
SCMB1205U26	US26	0.48
SCMB1205U26D	US26D	0.48
SCMB1205CR003	CR003	0.48

#10"x 1/2" Machine Screw

Part Number	Finish	List Price Each
SCMB1005U3	US3	0.48
SCMB1005U5	US5	0.48
SCMB1005U10B	US10B	0.48
SCMB1005U15	US15	0.48
SCMB1005U15A	US15A	0.48
SCMB1005U26	US26	0.48
SCMB1005U26D	US26D	0.48
SCMB1005CR003	CR003	0.48

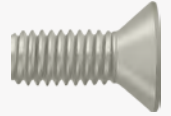
Replacement Rubber Bumper Bands
For Universal Floor Bumpers

Part Number	Finish	List Price Each
UFB4505RUB	Gray	3.00
UFB4505RUB-BK	Black	3.00

For Universal Square Floor Bumpers

Part Number	Finish	List Price Each
RUBBERTIP-UFBSG	Gray	3.00
RUBBERTIP-UFBS	Black	3.00

Accessories for Screen and Storm Door Latches / Solid Brass
Accessory Lever Set For SDML334

Part Number	Finish	List Price Each
SDML334/LLU3	US3	23.00
SDML334/LLU10B	US10B	26.00
SDML334/LLU15	US15	26.00
SDML334/LLU19	US19	26.00
SDML334/LLU26D	US26D	26.00

Accessory knob Set For SDML334

Part Number	Finish	List Price Each
SDML334/KKU3	US3	23.00
SDML334/KKU10B	US10B	26.00
SDML334/KKU15	US15	26.00
SDML334/KKU19	US19	26.00
SDML334/KKU26D	US26D	26.00

Accessory Lever/Knob Set For SDML334

Part Number	Finish	List Price Each
SDML334U3/REPL	US3	23.00
SDML334U5/REPL	US5	26.00
SDML334U10B/REPL	US10B	26.00
SDML334U15/REPL	US15	26.00
SDML334U15A/REPL	US15A	26.00
SDML334U19/REPL	US19	26.00
SDML334U26/REPL	US26	26.00
SDML334U26D/REPL	US26D	26.00
SDML334CR003/REPL	CR003	26.00

Accessory Lever For SDL980 / SDLS480

Part Number	Finish	List Price Each
SDLLEVERU3	US3	11.00
SDLLEVERU3-UNL	US3-UNL	11.00
SDLLEVERU10B	US10B	12.00
SDLLEVERU15	US15	12.00
SDLLEVERU19	US19	12.00

Accessory Knob For SDL980 / SDLS480

Part Number	Finish	List Price Each
SDLKNOBU3	US3	11.00
SDLKNOBU3-UNL	US3-UNL	11.00
SDLKNOBU10B	US10B	12.00
SDLKNOBU15	US15	12.00
SDLKNOBU19	US19	12.00

Accessory Lever For SDL688

Part Number	Finish	List Price Each
SDL688U3/LEVER	US3	11.00
SDL688U5/LEVER	US5	12.00
SDL688U10B/LEVER	US10B	12.00
SDL688U15/LEVER	US15	12.00
SDL688U15A/LEVER	US15A	12.00
SDL688U19/LEVER	US19	12.00
SDL688U26/LEVER	US26	12.00
SDL688U26D/LEVER	US26D	12.00
SDL688CR003/LEVER	CR003	14.00

Accessory Knob For SDL688

Part Number	Finish	List Price Each
SDL688U3/KNOB	US3	11.00
SDL688U5/KNOB	US5	12.00
SDL688U10B/KNOB	US10B	12.00
SDL688U15/KNOB	US15	12.00
SDL688U15A/KNOB	US15A	12.00
SDL688U19/KNOB	US19	12.00
SDL688U26/KNOB	US26	12.00
SDL688U26D/KNOB	US26D	12.00
SDL688CR003/KNOB	CR003	14.00



Surface Bolt Accessories

Square Knob / Solid Brass

Part Number	Finish	List Price/Each
KBSU3	US3	5.00
KBSU5	US5	6.00
KBSU10B	US10B	6.00
KBSU14	US14	6.00
KBSU15	US15	6.00
KBSU15A	US15A	6.00
KBSU19	US19	6.00
KBSU26	US26	6.00
KBSU26D	US26D	6.00
KBSCR003	CR003	8.00

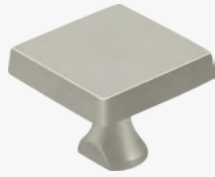

Square Knob Width: 1 1/8"

Offset Heavy Duty Strike / Solid Brass

Part Number	Finish	List Price/Each
FPGHDBU5	US5	8.00
FPGHDBU10B	US10B	8.00
FPGHDBU14	US14	8.00
FPGHDBU15	US15	8.00
FPGHDBU15A	US15A	8.00
FPGHDBU26	US26	8.00
FPGHDBCR003	CR003	9.00



Pins for Steel Residential Hinges

Pin for 3 1/2" x 3 1/2"

Part Number	Finish	List Price Each
PIN-ST35U1B	US1B	2.20
PIN-ST35U3	US3	2.20
PIN-ST35U4	US4	2.20
PIN-ST35U5	US5	2.20
PIN-ST35U10B	US10B	2.20
PIN-ST35U15	US15	2.20
PIN-ST35U15A	US15A	2.20
PIN-ST35U26	US26	2.20
PIN-ST35U26D	US26D	2.20



Pin for 4" x 4"

Part Number	Finish	List Price Each
PIN-ST4U1B	US1B	2.75
PIN-ST4U3	US3	2.75
PIN-ST4U4	US4	2.75
PIN-ST4U5	US5	2.75
PIN-ST4U10B	US10B	2.75
PIN-ST4U15	US15	2.75
PIN-ST4U15A	US15A	2.75
PIN-ST4U26	US26	2.75
PIN-ST4U26D	US26D	2.75



Stainless Steel Pins For Solid Brass Hinges

Stainless Steel Pins for Solid Brass Hinges

Part Number	Application	List Price Each
HPR35	For DSB35 - 3 1/2" hinges	2.40
HPR40	For DSB4 - 4" hinges	2.40
HPR45	For DSB45 - 4 1/2" hinges	2.95
HPR50	For DSB5 - 5" hinges	2.95

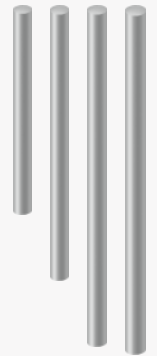

Screw Covers / Solid Brass

1" Diameter Round / Dimple

Part Number	Finish	List Price Each	BOX QTY
SCD100U3	US3	3.25	50 PC
SCD100U5	US5	4.35	
SCD100U10B	US10B	4.35	
SCD100U15	US15	4.35	CASE QTY
SCD100U15A	US15A	4.35	500 PC
SCD100U19	US19	4.35	
SCD100U26	US26	4.35	
SCD100U26D	US26D	4.35	
SCD100CR003	CR003	5.45	



1" Diameter Round / Flat

Part Number	Finish	List Price Each	BOX QTY
SCF100U3	US3	3.25	50 PC
SCF100U5	US5	4.35	
SCF100U10B	US10B	4.35	
SCF100U15	US15	4.35	CASE QTY
SCF100U15A	US15A	4.35	500 PC
SCF100U19	US19	4.35	
SCF100U26	US26	4.35	
SCF100U26D	US26D	4.35	
SCF100CR003	CR003	5.45	

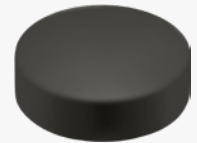

Replacement Bell Button Mechanism

BBC20 Replacement Bell Button

Part Number	Finish	List Price Each
BBC20-REPLU3	US3	6.00
BBC20-REPLU5	US5	6.50
BBC20-REPLU10B	US10B	6.50
BBC20-REPLU15	US15	6.50
BBC20-REPLU15A	US15A	6.50
BBC20-REPLU19	US19	6.50
BBC20-REPLU26	US26	6.50
BBC20-REPLU26D	US26D	6.50
BBC20-REPL003	CR003	7.00



The Deltana GAMBIT / Solid Brass

HOW TO PLAY

- 1) Everyone antes up one chip.
- 2) Each person takes a turn to spin the Gambit.
- 3) If it lands on "T1, T2 or T3" that means TAKE 1, 2 or 3 out of the pot.
- 4) If it lands on "P1, P2 or P3" that means PUT that amount into the pot.
- 5) If it lands on "AP" everybody put one chip into the pot, in high stakes games match the entire pot!
- 6) Each Round is played until a player lands "TA" or TAKE ALL to finish the round.
- 7) The game is won when all but the last player are out of chips.



List Price: \$9.99

Door Closers & Accessories

	Pages
DC50.....	13 - 2
DC70.....	13 - 3
DC10.....	13 - 4
DC90.....	13 - 5
DC40.....	13 - 6
Door Closer Accessories.....	13 - 7



DC50

Part Number	Finish	List Price Each	SIZE #2	CASE QTY 10 PCS
DC50-ALUM	Aluminum	66.00		
DC50-DURO	Duro	66.00		
DC50-GOLD	Gold	66.00		
DC50-WHITE	White	66.00		
			MAX DOOR WEIGHT 75 LBS	CASE WEIGHT 40 LBS

Latching Power Adjustment

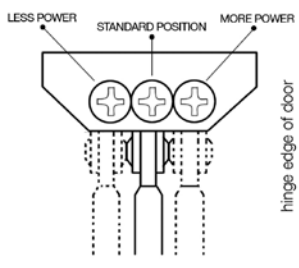

The position of the arm of the DC50 can be changed, which affects the amount of leverage it applies, without having to remove its shoe.

Rotation and Adjustable Ranges

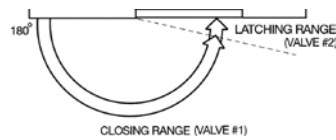

- Spring power size #2
- Adjustable closing speed (Valve #1)
- Adjustable latching speed (Valve #2)
- Universal handing
- High lubricity fluid
- Parallel bracket included
- Small body profile
- Ideal for Interior Doors
- Die-Cast Aluminum body, Stamped Steel arm



APPLICATIONS

STANDARD

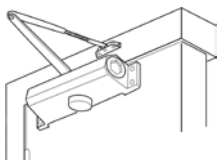

PARALLEL ARM

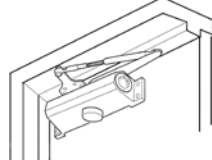

TOP JAMB

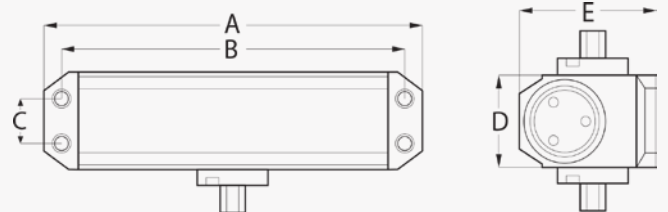
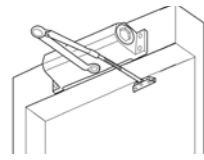

Specifications

A. Length of Closer Body	7 3/16"
B. Horizontal Mounting Holes	6 1/2"
C. Vertical Mounting Holes	3/4"
D. Height of Door Closer Body	1 5/8"
E. Projection from Door	2 3/8"

DC70

Part Number	Finish	List Price Each	SIZE #3	CASE QTY 10 PCS
DC70-AL	Aluminum	91.00		
DC70-DURO	Duro	91.00	MAX DOOR WEIGHT 140 LBS	CASE WEIGHT 60 LBS
DC70-GOLD	Gold	91.00		
DC70-WHITE	White	91.00		

Latching Power Adjustment

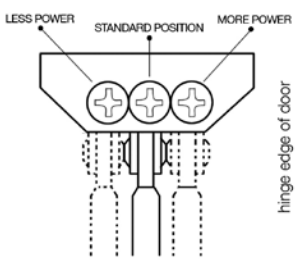

The position of the arm of the DC70 can be changed, which affects the amount of leverage it applies, without having to remove its shoe.

Rotation and Adjustable Ranges

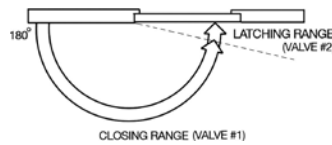

Backcheck

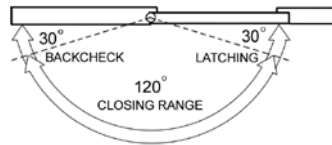

Slows a Door during the cycle, by providing cushioned resistance to a forceful opening. Designed to protect people and objects behind the door and to prevent damage to the closer, hardware and wall.

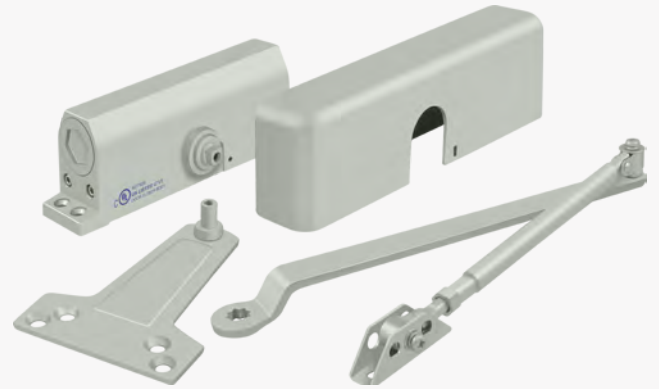

- UL and CUL Listed
- Spring power size #3
- Adjustable closing speed (Valve #1)
- Adjustable latching speed (Valve #2)
- Adjustable backcheck function (BC Valve)
- Universal handing
- High lubricity fluid
- Pararell bracket, cover and sex-bolts included
- Die-Cast Aluminum body, Stamped Steel arm



APPLICATIONS

STANDARD

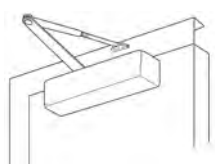

PARALLEL ARM

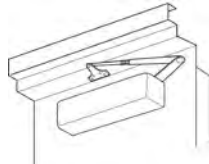

TOP JAMB

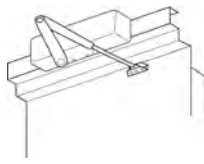

Comparison Chart

CAL ROYAL	NORTON	YALE	DORMA	TAYMOR	PARKER
700	1600	50	7000	600	500

This table represents a comparison of the most similar competitor models to the Deltana brand. Comparative models are not identical to Deltana brand closers and are not meant to be represented as such.

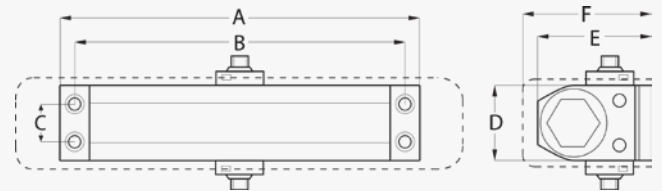

Specifications

A. Length of Closer Body	8 7/8"
B. Horizontal Mounting Holes	8 3/16"
C. Vertical Mounting Holes	3/4"
D. Height of Door Closer Body	1 7/8"
E. Projection from Door	2 5/8"
F. Projection from Door with Cover	3"

DC10

Part Number	Finish	List Price Each	SIZE ADJUSTS #1 ~ 4	CASE QTY 10 PCS
DC10-AL	Aluminum	122.00		
DC10-DURO	Duro	122.00		
DC10-GOLD	Gold	122.00		
DC10-WHITE	White	122.00		

MAX DOOR WEIGHT 180 LBS	CASE WEIGHT 60 LBS
-------------------------	--------------------

Latching Power Adjustment

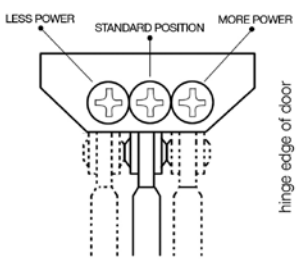

The position of the arm of the DC10 can be changed, which affects the amount of leverage it applies, without having to remove its shoe.

Rotation and Adjustable Ranges

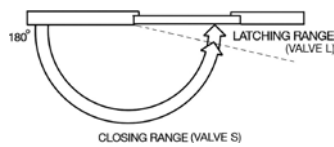

Backcheck

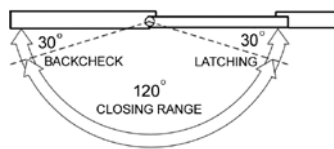

Slows a Door during the cycle, by providing cushioned resistance to a forceful opening. Designed to protect people and objects behind the door and to prevent damage to the closer, hardware and wall.

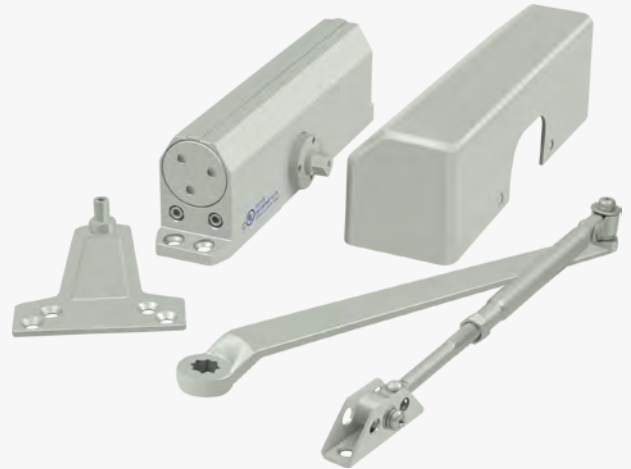

- UL and CUL listed, UL 10C fire rated
- Factory tested to exceed ANSI A 156.4 Grade 1
- Compliant with ANSI A 117.1
- Spring power size 1 to 4
- Adjustable latching speed (Valve L)
- Adjustable sweeping speed (Valve S)
- Adjustable backcheck functions (BC Valve)
- Meets handicap requirements, barrier free operation
- Universal handing
- High lubricity fluid
- Parallel bracket, cover & sex bolts included
- Die-cast Aluminum body. Forged Steel arm.



APPLICATIONS

STANDARD

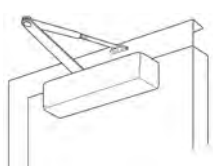

PARALLEL ARM

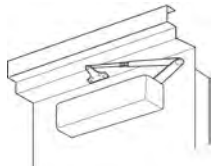

TOP JAMB

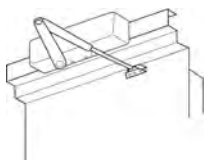

Comparison Chart

LCN	STANLEY	ARROW	HAGER	NORTON
1260	D3550	DC214	5300	1601

This table represents a comparison of the most similar competitor models to the Deltana brand. Comparative models are not identical to Deltana brand closers and are not meant to be represented as such.

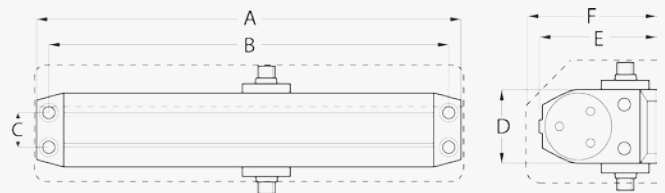

Specifications

A. Length of Closer Body	9 10/16"
B. Horizontal Mounting Holes	9"
C. Vertical Mounting Holes	3/4"
D. Height of Door Closer Body	1 3/4"
E. Projection from Door	2 3/4"
F. Height of Door Closer with Cover	3"

DC90

Part Number	Finish	List Price Each	SIZE ADJUSTS #1 ~ 6	CASE QTY 6 PCS
DC90-AL	Aluminum	130.00		
DC90-DURO	Duro	130.00	MAX DOOR WEIGHT	CASE WEIGHT
DC90-GOLD	Gold	130.00	330 LBS	70 LBS
DC90-WHITE	White	130.00		

Latching Power Adjustment

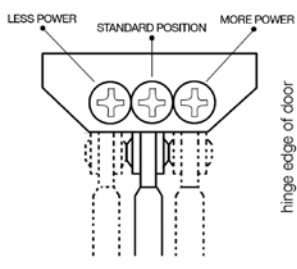

The position of the arm of the DC90 can be changed, which affects the amount of leverage it applies, without having to remove its shoe.

Rotation and Adjustable Ranges

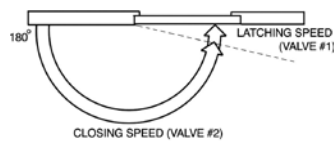

Backcheck

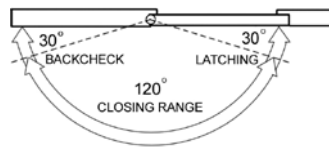

Slows a Door during the cycle, by providing cushioned resistance to a forceful opening. Designed to protect people and objects behind the door and to prevent damage to the closer, hardware and wall.

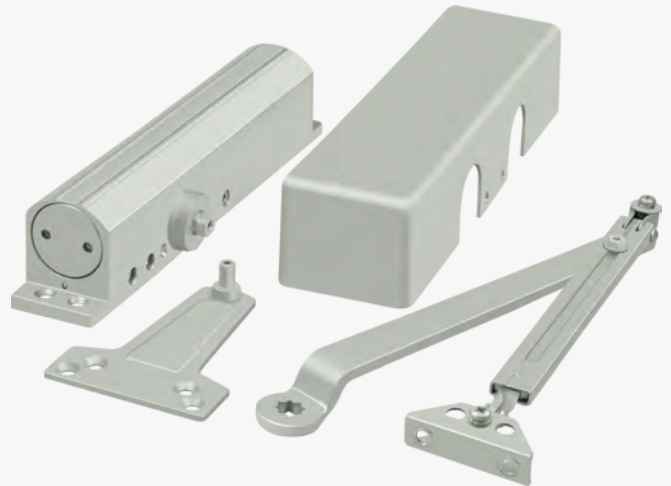

- UL and CUL Listed
- Factory tested to exceed ANSI A 156.4 Grade 1
- Compliant with ANSI A 117.1
- Spring power size 1 to 6
- Adjustable latching speed (Valve #1)
- Adjustable closing speed (Valve #2)
- Adjustable backcheck functions (BC Valve)
- Meets handicap requirements, barrier free operation
- Universal handing
- High lubricity fluid
- Parallel bracket, cover & sex bolts included
- Die-Cast Aluminum body, Stamped Steel arm



APPLICATIONS		
STANDARD	PARALLEL ARM	TOP JAMB

Comparison Chart						
CAL ROYAL	CORBIN	DORMA	LCN	NORTON	SARGENT	YALE
900 Full Cover	DC3200	8600	1460	8501	1230	3501

This table represents a comparison of the most similar competitor models to the Deltana brand. Comparative models are not identical to Deltana brand closers and are not meant to be represented as such.

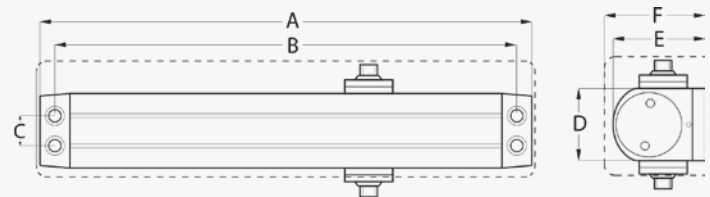

Specifications	
A. Length of Closer Body	11 7/8"
B. Horizontal Mounting Holes	11 1/8"
C. Vertical Mounting Holes	3/4"
D. Height of Door Closer Body	2"
E. Projection from Door	2 3/8"
F. Projection from Door with Cover	2 1/2"

DC40

Part Number	Finish	List Price Each	SIZE ADJUSTS #1 ~ 6	CASE QTY 4 PCS
DC40-AL	Aluminum	185.00		
DC40-DURO	Duro	185.00		
DC40-GOLD	Gold	185.00		
DC40-WHITE	White	185.00		

MAX DOOR WEIGHT 330 LBS	CASE WEIGHT 60 LBS
-------------------------	--------------------

Rotation and Adjustable Ranges

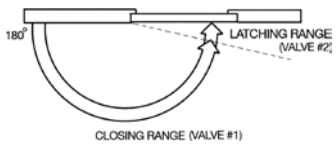

Backcheck

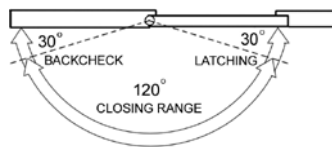

Slows a Door during the cycle, by providing cushioned resistance to a forceful opening. Designed to protect people and objects behind the door and to prevent damage to the closer, hardware and wall.

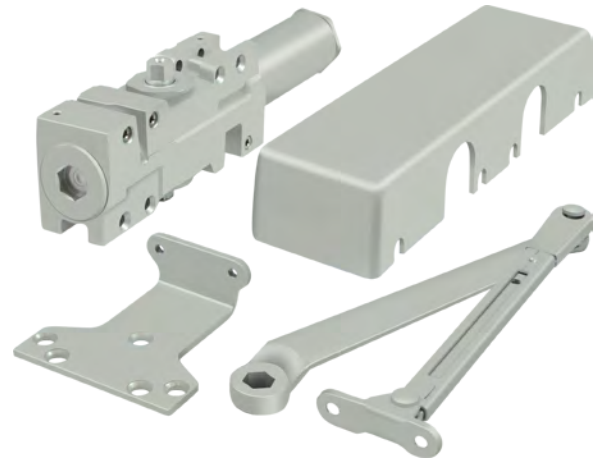

- UL and CUL listed, UL 10C fire rated
- ANSI A 156.4 Grade 1 certified.
- Compliant with ANSI A 117.1
- Spring power size 1 to 6
- Adjustable closing speed
- Adjustable latching speed
- Adjustable backcheck functions
- Meets handicap requirements, barrier free operation
- Universal handing
- High lubricity fluid
- Paralell bracket, cover & sex bolts included
- Cast Iron body, Forged Steel arm.

APPLICATIONS

STANDARD

PARALLEL ARM

TOP JAMB

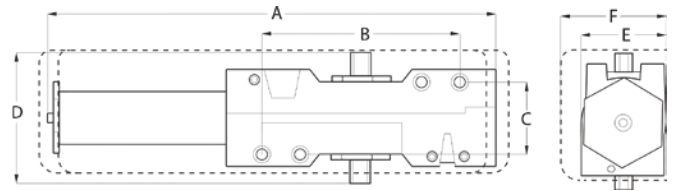

Comparison Chart					
LCN	CAL ROYAL	YALE	NORTON	DORMA	SARGENT
4041	CR441	4400	7700	8900	350

This table represents a comparison of the most similar competitor models to the Deltana brand. Comparative models are not identical to Deltana brand closers and are not meant to be represented as such.

Specifications	
A. Length of Closer Body	11 7/8"
B. Horizontal Mounting Holes	5"
C. Vertical Mounting Holes	9/16"
D. Height of Door Closer Body	2"
E. Projection from Door	2 5/16"
F. Height of Door Closer with Cover	2 1/2"

Door Closer Accessories
Cushion Arm for DC40

Part Number	Finish	List Price Each
DCCA4041-AL	Aluminum	75.00
DCCA4041-DURO	Duro	75.00
DCCA4041-GOLD	Gold	75.00

Drop Plate for Standard Arm Installation

Part Number	Finish	List Price Each
DP4041S-AL	Aluminum	40.00
DP4041S-DURO	Duro	40.00
DP4041S-GOLD	Gold	40.00
DP4041S-WHITE	White	40.00

Hold Open Arm for DC40

Part Number	Finish	List Price Each
DCHA4041-AL	Aluminum	75.00
DCHA4041-DURO	Duro	75.00
DCHA4041-GOLD	Gold	75.00

Drop Plate for Parallel Arm Installation

Part Number	Finish	List Price Each
DP4041P-AL	Aluminum	40.00
DP4041P-DURO	Duro	40.00
DP4041P-GOLD	Gold	40.00
DP4041P-WHITE	White	40.00

Hold Open Arm for DC10

Part Number	Finish	List Price Each
DCHA1050-AL	Aluminum	68.00
DCHA1050-DURO	Duro	68.00

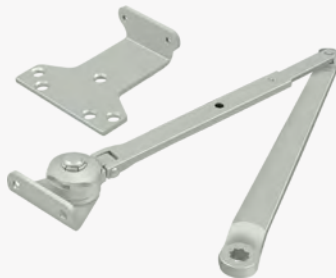
Sex Bolts / 4 PCS Set

Part Number	Finish	List Price Set
DCSB175-AL	Aluminum	6.00
DCSB175-DURO	Duro	6.00
DCSB175-GOLD	Gold	6.00
DCSB175-WHITE	White	6.00

Screw: #12 x 24mm



Commercial Door Hardware

	Pages
Grade 1 Clarendon Lever.....	14 - 3
Grade 1 Deadbolts.....	14 - 3
Grade 1 Clarendon Lever IC Core.....	14 - 3
Grade 2 Clarendon Lever.....	14 - 4
Grade 2 Deadbolts.....	14 - 4
Grade 2 Curved Lever.....	14 - 5
Grade 2 Round Knobs.....	14 - 5
Grade 2 Interconnected.....	14 - 6
Grade 2 Clarendon Lever IC Core.....	14 - 6
Grade 2 Light Duty Locks.....	14 - 7
Exit Devices.....	14 - 8
Exit Device Trim kits.....	14 - 8
Latches, UL Listed.....	14 - 9
Strikes & Miscellaneous Items.....	14 - 9



- Key alike and master key available.
- 2 3/8" backset latches available upon request.

Commercial Grade Door Hardware Specifications

Strikes

UL Listed ANSI 1 1/4"x 4 7/8" strike standard.
 T-Strikes: 1 1/4"x 2 3/4" sold separately.
 Deadbolts come with a no lip square 1 1/8"x 2 3/4" strike plate.

Cylinder

Solid Brass 6-pin, Schlage C compatible keyway. Pinned 6 with two 6-pin keys standard.

Trim

Grade 1 - fixed through bolts
 Grade 2 - removable through bolts

Latch UL Approved

2 3/4" backset latch included with 1/2" throw. Drive-in latch models also sold for Grade 2. Housing is steel-zinc dichromated finish for rust resistance. 1" diameter bore is required.

*Option of 2 3/8" backset latch is available upon request.

Latch Face Plate

Solid Brass / Stainless Steel 2 1/4"x 1 1/8" standard. 2 1/4"x 1" latches sold separately.

Keying

Keying available for our complete line of commercial door hardware.

Housing

Cold rolled steel and zinc dichromated finish for rust resistance. Door prep is a 2 1/8" bore, with 5/16" holes for through bolts.

Interchangeable Core (IC)

Locks are prepped for a small format IC core, compatible with Schlage, Best, Falcon and Arrow cores. Locks are supplied without cylinder core.

Clutch Function

When locked, the lever turns freely without retracting the latch to avoid damage to the mechanism. All Deltana commercial door hardware has this added function.

Universal Handing.

Door Thickness Range 1 3/8" ~ 2".

Meets ANSI 156.2 Grade 1 & 2 requirements.

Deltana commercial locks and exit devices are made in Taiwan.

Schematic drawings available Online.

		Series Functions and Options		
Outside	Inside	Type	Ansi #	Function Description
		Passage	F75	Always unlocked. Latchbolt operated by lever from either side at all times.
		Bath / Bedroom Privacy	F76	Latchbolt operated by lever from either side. Outside lever can be locked by a locking Push-button located inside, can be unlocked from outside with the emergency release or from inside by turning lever or closing door.
		Entrance	F82	- Turn / Push-button locking: pushing and turning button locks outside lever requiring use of key until button is manually unlocked. - Push-button locking (Auto egress function): pushing button locks outside lever until unlocked by key or inside lever is turned. Deadlocking latchbolt operated by inside lever at all times.
		Classroom	F84	Latchbolt operated by lever from either side. Inside lever is always unlocked. Outside lever can be locked by key from the outside. Outside lever can be unlocked by key from outside or turning inside lever.
		Storeroom	F86	Latchbolt operated by key in outside lever or rotating inside lever. Outside lever is always locked and inside lever is always unlocked.
		Dummy	N/A	Dummy levers and knobs are fixed, they do not have a function other than to aesthetically complete a project or to operate as a simple pull would. They do not turn, operate a latch or have any locking function.



Clarendon



Curved



Round Knob



Curved - Light Duty



Straight - Light Duty

Commercial Grade 1 / Clarendon Lever

Commercial Grade 1 / Deadbolts & IC Levers

Entry

Part Number	Finish	List Price Each
CL500FLC-3	US3	126.00
CL500FLC-10B	US10B	138.00
CL500FLC-26D	US26D	126.00

CASE QTY 6 PC

Passage

Part Number	Finish	List Price Each
CL501FLC-3	US3	114.00
CL501FLC-10B	US10B	125.00
CL501FLC-26D	US26D	114.00

CASE QTY 6 PC

Privacy

Part Number	Finish	List Price Each
CL502FLC-3	US3	118.00
CL502FLC-10B	US10B	130.00
CL502FLC-26D	US26D	118.00

CASE QTY 6 PC

Storeroom

Part Number	Finish	List Price Each
CL504FLC-3	US3	126.00
CL504FLC-10B	US10B	138.00
CL504FLC-26D	US26D	126.00

CASE QTY 6 PC

Classroom

Part Number	Finish	List Price Each
CL509FLC-3	US3	126.00
CL509FLC-10B	US10B	138.00
CL509FLC-26D	US26D	126.00

CASE QTY 6 PC

SPECIFICATIONS

- Non-handed clutch system lever
 - Door Thickness: 1 3/8" ~ 2"
 - Backset: 2 3/4" latch UL listed included
 - Strike: ANSI 4 7/8" x 1 1/4" lip-to-center
 - Fixed Through-bolts
- Latch: UL listed, 1/2" throw

*Optional 2 3/8" backset latch replacement available upon request.

Single Deadbolt

Part Number	Finish	List Price Each
CL200LM-3	US3	70.00
CL200LM-26D	US26D	70.00

CASE QTY 12 PC

Double Deadbolt

Part Number	Finish	List Price Each
CL210LM-3	US3	90.00
CL210LM-26D	US26D	90.00

CASE QTY 12 PC

Single Deadbolt IC Core Non Cyl

Part Number	Finish	List Price Each
CL200LMIC-26D	US26D	94.00

CASE QTY 12 PC

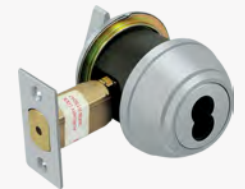
SPECIFICATIONS

- Backset: 2 3/4"
- Latch Bolt: 1 1/8" x 2 1/4"
1" Throw UL Listed
- Strike: No lip-square corner 1-1/8" x 2-3/4" with frame reinforcer & dust box
- Cylinder: 6-pin solid brass "C" Keyway

Entry Interchangeable Core (IC)

Part Number	Finish	List Each
CL500FRCNC-3	US3	130.00
CL500FRCNC-26D	US26D	130.00

NO CYLINDER CASE QTY 10 PC

Classroom Interchangeable Core (IC)

Part Number	Finish	List Each
CL509FRCNC-3	US3	130.00
CL509FRCNC-26D	US26D	130.00

NO CYLINDER CASE QTY 6 PC

SPECIFICATIONS

- Locks are prepped for a small format IC core
- Compatible with Schlage, Best, Falcon and Arrow cores
- Locks are supplied without cylinder core

Storeroom Interchangeable Core (IC)

Part Number	Finish	List Each
CL504FRCNC-3	US3	130.00
CL504FRCNC-26D	US26D	130.00

NO CYLINDER CASE QTY 6 PC

Commercial Grade 2 / Clarendon Lever

Commercial Grade 2 / Deadbolts

Entry

Part Number	Finish	List Price Each
CL500EVC-3	US3	98.00
CL500EVC-10B	US10B	105.00
CL500EVC-26D	US26D	98.00

CASE QTY
6 PC

Passage

Part Number	Finish	List Price Each
CL501EVC-3	US3	90.00
CL501EVC-10B	US10B	98.00
CL501EVC-26D	US26D	90.00

CASE QTY
6 PC

Privacy

Part Number	Finish	List Price Each
CL502EVC-3	US3	92.00
CL502EVC-10B	US10B	100.00
CL502EVC-26D	US26D	92.00

CASE QTY
6 PC

Storeroom

Part Number	Finish	List Price Each
CL504EVC-3	US3	98.00
CL504EVC-10B	US10B	105.00
CL504EVC-26D	US26D	98.00

CASE QTY
6 PC

Classroom

Part Number	Finish	List Price Each
CL509EVC-3	US3	98.00
CL509EVC-10B	US10B	105.00
CL509EVC-26D	US26D	98.00

CASE QTY
6 PC

Dummy

Part Number	Finish	List Price Each
CL515EVC-3	US3	50.00
CL515EVC-10B	US10B	56.00
CL515EVC-26D	US26D	50.00

CASE QTY
10 PC

SPECIFICATIONS

- Non-handed clutch system lever
- Door Thickness: 1 3/8" ~ 2"
- Backset: 2 3/4" latch included
- Latch: UL listed, 1/2" throw
- Strike: ANSI 4 7/8" x 1 1/4"
- Cylinder: 6-pin solid brass "C" keyway standard
- Removable Through-bolts

*Optional 2 3/8" backset latch replacement available upon request.

Single Deadbolt

Part Number	Finish	List Price Each
CL200LA-3	US3	49.00
CL200LA-10B	US10B	56.00
CL200LA-32D	US32D	49.00

CASE QTY
20 PC

Double Deadbolt

Part Number	Finish	List Price Each
CL210LA-3	US3	60.00
CL210LA-10B	US10B	68.00
CL210LA-32D	US32D	60.00

CASE QTY
20 PC

Interchangeable Core (IC)

Part Number	Finish	List Price Each
CL200LAIC-26D	US26D	71.00

NO CYLINDER **CASE QTY**
20 PC

SPECIFICATIONS

- Backset: 2 3/4" latch included,
- Cylinder: 6-pin solid brass "C" keyway standard
- Latch: 1 1/8" x 2 1/4", UL Listed, 1" throw
- Strike: 1 1/8" x 2 3/4" no lip
- Square corner latch

Commercial Grade 2 / Curved Lever

Commercial Grade 2 / Round Knob

Entry

Part Number	Finish	List Price Each
CL600EVC-10B	US10B	109.00
CL600EVC-26D	US26D	104.00
		CASE QTY 6 PC



Passage

Part Number	Finish	List Price Each
CL601EVC-10B	US10B	102.00
CL601EVC-26D	US26D	94.00
		CASE QTY 6 PC



Privacy

Part Number	Finish	List Price Each
CL602EVC-10B	US10B	104.00
CL602EVC-26D	US26D	96.00
		CASE QTY 6 PC



Storeroom

Part Number	Finish	List Price Each
CL604EVC-10B	US10B	109.00
CL604EVC-26D	US26D	104.00
		CASE QTY 6 PC



Classroom

Part Number	Finish	List Price Each
CL609EVC-10B	US10B	109.00
CL609EVC-26D	US26D	104.00
		CASE QTY 6 PC



SPECIFICATIONS

- Non-handed clutch system lever
- Door Thickness: 1 3/8" ~ 2"
- Backset: 2 3/4" latch included
- Strike: ANSI 4 7/8" x 1 1/4"
- Latch: UL listed, 1/2" throw
- Cylinder: 6-pin solid brass "C" keyway standard
- Removable through-bolts

*Optional 2 3/8" backset latch replacement available upon request.

Entry

Part Number	Finish	List Price Each
CL100EAC-32D	US32D	48.00
		CASE QTY 20 PC



Passage

Part Number	Finish	List Price Each
CL101EAC-32D	US32D	44.00
		CASE QTY 20 PC



Privacy

Part Number	Finish	List Price Each
CL102EAC-32D	US32D	44.00
		CASE QTY 20 PC

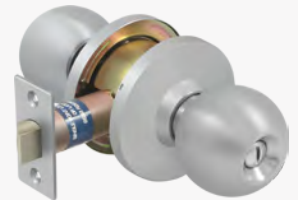

Storeroom

Part Number	Finish	List Price Each
CL104EAC-32D	US32D	48.00
		CASE QTY 20 PC



Classroom

Part Number	Finish	List Price Each
CL109EAC-32D	US32D	52.00
		CASE QTY 20 PC

Dummy

Part Number	Finish	List Price Each
CL115EAC-32D	US32D	34.00
		CASE QTY 90 PC



SPECIFICATIONS

- Door Thickness: 1 3/8" ~ 1 3/4"
- Backset: 2 3/4" latch included
- Latch: UL listed, 1/2" throw
- Cylinder: 6-pin solid brass "C" keyway standard
- Strike: ANSI 4 7/8" x 1 1/4"

Commercial Grade 2 / Interconnected Locks

Entry with Clarendon

Part Number	Finish	List Price Each
CL300ILC-3	US3	189.00
CL300ILC-26D	US26D	189.00

CASE QTY
 10 PC

SPECIFICATIONS

- Door Thickness: 1 3/8" ~ 1 3/4"
- Backset: 2 3/4" latch included
- Cylinder: 6-pin, solid brass "C" keyway standard
- Deadbolt latch: UL Listed, 1/2" throw
- Latch Bolt: UL Listed, chrome plated 1/2" throw
- Center to Center: 4"
- Non-clutch

Passage with Clarendon

Part Number	Finish	List Price Each
CL308ILC-3	US3	178.00
CL308ILC-26D	US26D	178.00

CASE QTY
 10 PC

SPECIFICATIONS

- Door Thickness: 1 3/8" ~ 1 3/4"
- Backset: 2 3/4" latch included
- Cylinder: 6-pin, solid brass "C" keyway standard
- Deadbolt latch: UL Listed, 1/2" throw
- Latch Bolt: UL Listed, chrome plated 1/2" throw
- Center to Center: 4"
- Non-clutch

Commercial Grade 2 / Clarendon Lever / Interchangeable Core

Entry / Interchangeable Core

Part Number	Finish	List Price Each
CL500ECCNC-3	US3	112.00
CL500ECCNC-26D	US26D	112.00

NO CYLINDER | **CASE QTY**
 6 PC

Classroom / Interchangeable Core

Part Number	Finish	List Price Each
CL509ECCNC-3	US3	112.00
CL509ECCNC-26D	US26D	112.00

NO CYLINDER | **CASE QTY**
 6 PC

SPECIFICATIONS

- Locks are prepped for a small format IC core
- Compatible with Schlage, Best, Falcon and Arrow cores
- Locks are supplied less cylinder core
- Other specifications same as standard core leversets

Storeroom / Interchangeable Core

Part Number	Finish	List Price Each
CL504ECCNC-3	US3	112.00
CL504ECCNC-26D	US26D	112.00

NO CYLINDER | **CASE QTY**
 6 PC

*Optional 2 3/8" backset latch replacement available upon request.

Commercial Light Duty Grade 2 Locks

Entry

Part Number	Finish	List Price Each
CL700EL-10B	US10B	91.00
CL700EL-26D	US26D	84.00

 CASE
QTY
10 PC

Entry

Part Number	Finish	List Price Each
CL400EL-10B	US10B	91.00
CL400EL-26D	US26D	84.00

 CASE
QTY
10 PC

Privacy

Part Number	Finish	List Price Each
CL702EL-10B	US10B	82.00
CL702EL-26D	US26D	76.00

 CASE
QTY
10 PC

Privacy

Part Number	Finish	List Price Each
CL402EL-10B	US10B	82.00
CL402EL-26D	US26D	76.00

 CASE
QTY
10 PC

Passage

Part Number	Finish	List Price Each
CL701EL-10B	US10B	80.00
CL701EL-26D	US26D	74.00

 CASE
QTY
10 PC

Passage

Part Number	Finish	List Price Each
CL401EL-10B	US10B	80.00
CL401EL-26D	US26D	74.00

 CASE
QTY
10 PC

SPECIFICATIONS

- Non-handed clutch system lever
- Door Thickness: 1 3/8" ~ 1 3/4"
- Backset: 2 3/4" latch included
- Strike: T-Strike 2 3/4" x 1 3/4"
- Latch: UL listed, 1/2" throw
- Cylinder: 6-pin solid brass "C" keyway standard
- Removable through-bolts

SPECIFICATIONS

- Non-handed clutch system lever
- Door Thickness: 1 3/8" ~ 1 3/4"
- Backset: 2 3/4" latch included
- Strike: T-Strike 2 3/4" x 1 3/4"
- UL listed, 1/2" throw
- Cylinder: 6-pin solid brass "C" keyway standard
- Removable through-bolts

*Optional 2 3/8" backset latch replacement available upon request.

Standard Exit Devices

UL 3 Hour Fire-Rated / Stainless Steel

Part Number	Finish	Rim	List Price/ Each
PDR36UL-AL	US32D	36"	380.00

SPECIFICATIONS

- UL Listed
- Strike included
- 3 Hour Fire-Rated

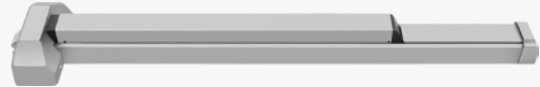

Standard / Cold Roll

Part Number	Finish	Rim	List Price/ Each
PDR36-AL	Aluminum	36"	215.00
PDR36-DURO	Duro (Brown)	36"	215.00

SPECIFICATIONS

- UL Listed
- Strike included
- Allen-key dogging
- Bar can be outdown to 30"



Part Number	Finish	Rim	List Price/ Each
PDR48-AL	Aluminum	48"	260.00

Vertical Exit Devices

Vertical Rod / UL 3 Hour Fire-Rated / Stainless Steel

Part Number	Finish	Rim	List Price/ Each
PDVR36UL-AL	US32D	36"	520.00

SPECIFICATIONS

- UL Listed
- Strike included
- 3 Hour Fire-Rated

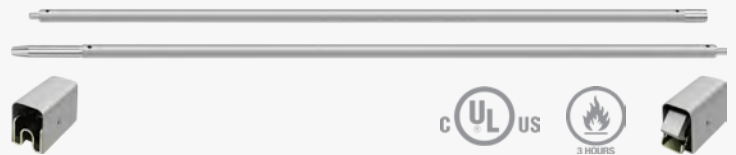

Vertical Rod / Standard / Cold Roll

Part Number	Finish	Rim	List Price/ Each
PDVR36-AL	Aluminum	36"	350.00
PDVR36-DURO	Duro (Brown)	36"	350.00

SPECIFICATIONS

- UL Listed
- Strike included
- Allen-key dogging
- Maximum door height 7'



Part Number	Finish	Rim	List Price/ Each
PDVR48-AL	Aluminum	48"	420.00

Exit Device Accessories

Lever Trim for Exit Device / Clarendon

Part Number	Finish	Function	List Price/ Each
LTED80LS-10B	US10B	Entry	100.00
LTED80LS-26D	US26D	Entry	100.00
LTED80LP-26D	US26D	Passage	95.00
LTED80LST-26D	US26D	Storeroom	100.00



LTED80LS-10B

Lever Trim for Exit Device / Curved

Part Number	Finish	Function	List Price/ Each
LTED60LST-26D	US26D	Storeroom	105.00



LTED60LS-26D

Double Door Strike for Exit Devices

Part Number	List Price/ Each
DDS-36	22.00



Latches / UL Listed

Part Number	Description	List Price Each
G1RLE238U3	G1 Reg. Latch, Entry 2 3/8" US3	17.00
G1RLE238U26D	G1 Reg. Latch, Entry 2 3/8" US26D	17.00
G1RLE275U3	G1 Reg. Latch, Entry 2 3/4" US3	17.00
G1RLE275U26D	G1 Reg. Latch, Entry 2 3/4" US26D	17.00

Part Number	Description	List Price Each
G1RLP238U3	G1 Reg. Latch, Passage 2 3/8" US3	17.00
G1RLP238U26D	G1 Reg. Latch, Passage 2 3/8" US26D	17.00
G1RLP275U3	G1 Reg. Latch, Passage 2 3/4" US3	17.00
G1RLP275U26D	G1 Reg. Latch, Passage 2 3/4" US26D	17.00



G1RLE275U26D

Part Number	Description	List Price Each
G2DLDBU3	G2 Drive-in-Latch, Adj-Deadbolt 2 3/8" ~ 2 3/4" US3	17.00
G2DLDBU26D	G2 Drive-in-Latch, Adj-Deadbolt 2 3/8" ~ 2 3/4" US26D	17.00

G2DLE238U32D	G2 Drive-in-Latch, Entry 2 3/8" US32D	17.00
G2DLE275U32D	G2 Drive-in-Latch, Entry 2 3/4" US32D	17.00
G2DLP238U32D	G2 Drive-in-Latch, Privacy/Passage 2 3/8" US32D	17.00
G2DLP275U32D	G2 Drive-in-Latch, Privacy/Passage 2 3/4" US32D	17.00



G2DLDBU26D



G2DLE275U32D

Part Number	Description	List Price Each
G2RLE238U3	G2 Reg. Latch, Entry 2 3/8" US3	17.00
G2RLE238U10B	G2 Reg. Latch, Entry 2 3/8" US10B	17.00
G2RLE238U26D	G2 Reg. Latch, Entry 2 3/8" US26D	17.00
G2RLPR238U3	G2 Reg. Latch, Privacy 2 3/8" US3	17.00
G2RLPR238U10B	G2 Reg. Latch, Privacy 2 3/8" US10B	17.00
G2RLPR238U26D	G2 Reg. Latch, Privacy 2 3/8" US26D	17.00

Part Number	Description	List Price Each
G2RLP238U3	G2 Reg. Latch, Passage 2 3/8" US3	17.00
G2RLP238U10B	G2 Reg. Latch, Passage 2 3/8" US10B	17.00
G2RLP238U26D	G2 Reg. Latch, Passage 2 3/8" US26D	17.00



G2RLE275U26D

Part Number	Description	List Price Each
G2RLE275U3	G2 Reg. Latch, Entry 2 3/4" US3	17.00
G2RLE275U26D	G2 Reg. Latch, Entry 2 3/4" US26D	17.00
G2RLE375U26D	G2 Reg. Latch, Entry 3 3/4" US26D	17.00
G2RLP275U3	G2 Reg. Latch, Privacy/Passage 2 3/4" US3	17.00
G2RLP275U26D	G2 Reg. Latch, Privacy/Passage 2 3/4" US26D	17.00
G2RLP375U26D	G2 Reg. Latch, Privacy/Passage 3 3/4" US26D	17.00



G2RLP275U26D



G2RLP375U26D

Part Number	Description	List Price Each
G2RL1E275U26D	G2 Reg. 1" Face Plate, Entry 2 3/4" US26D	17.00
G2RL1P275U26D	G2 Reg. 1" Face Plate, Privacy/Passage 2 3/4" US26D	17.00

G2RLDBU3	G2 Reg. Latch Deadbolt 2 3/8" US3	17.00
G2RLDBU26D	G2 Reg. Latch Deadbolt 2 3/8" US26D	17.00
G2RLDBU10B	G2 Reg. Latch Deadbolt 2 3/8" US10B	17.00
G2RLDB75U3	G2 Reg. Latch Deadbolt 2 3/4" US3	17.00
G2RLDB75U26D	G2 Reg. Latch Deadbolt 2 3/4" US26D	17.00



G2RL1E275U26D



G2RLDBU26D

Strikes & Miscellaneous Items

Spacer / Tail Piece / Blank Key

Part Number	Description	List Price Each
BTP500	Spacer / Tail Piece	1.50
TPRC100	Tail Piece / Retaining Piece	2.00
SKB600	Blank Key (6 pin C keyway)	4.00

4-7/8" ANSI Strike Plates

Part Number	Description	List Price Each
SPAN478U3	Strike Plate / US3	11.50
SPAN478U10B	Strike Plate / US10B	11.50
SPAN478U26D	Strike Plate / US26D	11.50

2-3/4" Strike Plates

Part Number	Description	List Price Each
SPTS275U3	Strike Plate / US3	6.00
SPTS275U26D	Strike Plate / US26D	6.00



SKB600



BTP500



TPRC100



SPAN478U10B



SPTS275U26D

Residential Door Hardware

Elite Collection	Pages
Handlesets, Solid Brass.....	15 - 3
Levers, Solid Brass	15 - 4
Deadbolts, Solid Brass.....	15 - 5
Deadbolts, Zinc.....	15 - 5
Levers, Zinc.....	15 - 5
Traditional Collection	
Handlesets, Solid Brass.....	15 - 8
Levers.....	15 - 8
Knobs.....	15 - 12
Replacement Door Knobs.....	15 - 14
Deadbolts.....	15 - 14
Latches & Cylinders.....	15 - 15



▶ Custom finish plating available.

Residential Door Hardware

Grades

Handlesets, knobs, levers and Deadbolts are Residential Grade.

Elite Collection deadbolts are grade 2.

Traditional Collection deadbolts are grade 3.

Installation

Deltana residential door hardware is designed for interior applications except for handlesets and deadbolts. Missapplication voids warranty.

Limited Warranty

3-Year mechanical, 1-year finish limited warranty for residential grade door hardware.

Finish

Deltana Lock products are plated in an array of finishes that are highly resistant to tarnishing.

Backset

Our latches come with adjustable backsets 2-3/8" ~ 2-3/4" standard 2-1/8" bore hole preparation.

Latches

All knobs and levers come packaged with a mortise latch.

Keying / Mechanical

All locks utilize a five-pin system. Knobs and levers are built with a square drive mechanism for added durability. Please read each product model's details on individual keyway compatibility.

Series Functions and Options			
Outside	Inside	Type	Function Description
		Entry	Exterior side can be locked using a key on the exterior or a mechanism on the interior side. Designed for interior use only.
		Privacy	Exterior side can be locked on the interior side. In an emergency, it can unlock from the exterior using a coin or a screwdriver. Good for use with bedroom and bathroom doors.
		Passage	Always unlocked. Latchbolt operated by lever/knob from either side. Good for use with closets and doors that do not require locking.
		Single Dummy	A dummy knob/lever mounts to one side of a door, does not operate, and is designed for doors that do not have a bore hole. Dummies work well for ball catch doors and other applications where a latch mechanism is not needed and the look of a knob/lever is desired.
		Trim Kit	Functional Knob/Lever that pairs with a handleset kit.



Lacovia



Chapelton



Portmore



Mandeville

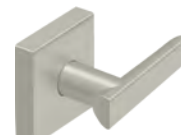

Livingston



Claremont



Trelawny



Savanna



Manchester



Linstead



Morant



Portland Knob



Round Knob



Egg Knob



Portland Knob

Entry Riversdale Handleset with Flat Round Knob

H	Part Number	Finish	List Price Each
	PRRHRKU3	US3	214.00
	PRRHRKU10B	US10B	214.00
	PRRHRKU15	US15	214.00
	PRRHRKU26	US26	214.00

Residential Grade 2 Deadbolt
Schlage C Keyway Compatible

Dummy Riversdale Handleset with Flat Round Knob

HDU	Part Number	Finish	List Price Each
	PRRHDRKU3	US3	214.00
	PRRHDRKU10B	US10B	214.00
	PRRHDRKU15	US15	214.00
	PRRHDRKU26	US26	214.00

Entry Riversdale Handleset with Chapelton Lever

H	Part Number	Finish	List Price Each
	PRRHCHU3	US3	214.00
	PRRHCHU10B	US10B	214.00
	PRRHCHU15	US15	214.00
	PRRHCHU26	US26	214.00

Residential Grade 2 Deadbolt
Schlage C Keyway Compatible

Dummy Riversdale Handleset with Chapelton Lever

HDU	Part Number	Finish	List Price Each
	PRRHDCU3	US3	214.00
	PRRHDCU10B	US10B	214.00
	PRRHDCU15	US15	214.00
	PRRHDCU26	US26	214.00

Entry Highgate Handleset with Zinc Livingston Lever

H	Part Number	Finish	List Price Each
	PRHHLU3	US3	238.00
	PRHHLU10B	US10B	238.00
	PRHHLU15	US15	238.00
	PRHHLU26	US26	238.00

Residential Grade 2 Deadbolt
Schlage C Keyway Compatible

Dummy Highgate Handleset with Zinc Livingston Lever

HDU	Part Number	Finish	List Price Each
	PRHHDLU3	US3	238.00
	PRHHDLU10B	US10B	238.00
	PRHHDLU15	US15	238.00
	PRHHDLU26	US26	238.00



H - Keyed Handleset

HDU - Dummy Handleset

Levers / Elite Collection / Solid Brass

Lacovia Lever / Privacy / R-Hand

PR	Part Number	Finish	List Price Each
<input type="checkbox"/>	PRLLR2U3-RH	US3	92.00
	PRLLR2U10B-RH	US10B	92.00
	PRLLR2U15-RH	US15	92.00
	PRLLR2U26-RH	US26	92.00

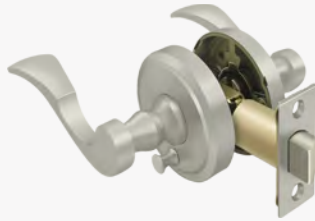
Chapelton Lever / Privacy / R-Hand

PR	Part Number	Finish	List Price Each
<input type="checkbox"/>	PRCLR2U3-RH	US3	92.00
	PRCLR2U10B-RH	US10B	92.00
	PRCLR2U15-RH	US15	92.00
	PRCLR2U26-RH	US26	92.00

Lacovia Lever / Privacy / L-Hand

PR	Part Number	Finish	List Price Each
<input type="checkbox"/>	PRLLR2U3-LH	US3	92.00
	PRLLR2U10B-LH	US10B	92.00
	PRLLR2U15-LH	US15	92.00
	PRLLR2U26-LH	US26	92.00

Chapelton Lever / Privacy / L-Hand

PR	Part Number	Finish	List Price Each
<input type="checkbox"/>	PRCLR2U3-LH	US3	92.00
	PRCLR2U10B-LH	US10B	92.00
	PRCLR2U15-LH	US15	92.00
	PRCLR2U26-LH	US26	92.00

Lacovia Lever / Passage / Universal

PA	Part Number	Finish	List Price Each
	PRLLR3U3	US3	92.00
	PRLLR3U10B	US10B	92.00
	PRLLR3U15	US15	92.00
	PRLLR3U26	US26	92.00

Chapelton Lever / Passage

PA	Part Number	Finish	List Price Each
	PRCLR3U3	US3	92.00
	PRCLR3U10B	US10B	92.00
	PRCLR3U15	US15	92.00
	PRCLR3U26	US26	92.00

Lacovia Lever / Dummy / R-Hand

DU	Part Number	Finish	List Price Each
	PRLLR4U3-RH	US3	45.00
	PRLLR4U10B-RH	US10B	45.00
	PRLLR4U15-RH	US15	45.00
	PRLLR4U26-RH	US26	45.00

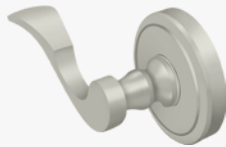
Chapelton Lever / Dummy

DU	Part Number	Finish	List Price Each
	PRCLR4U3	US3	45.00
	PRCLR4U10B	US10B	45.00
	PRCLR4U15	US15	45.00
	PRCLR4U26	US26	45.00

Lacovia Lever / Dummy / L-Hand

DU	Part Number	Finish	List Price Each
	PRLLR4U3-LH	US3	45.00
	PRLLR4U10B-LH	US10B	45.00
	PRLLR4U15-LH	US15	45.00
	PRLLR4U26-LH	US26	45.00



Privacy Lever with thumb-push lock on the inside and emergency release on the outside.

Privacy Lever with thumb-push lock on the inside and emergency release on the outside.

PR - Privacy Function

PA - Passage Function

DU - Dummy Function

Deadbolts / Elite Collection

Schlage C Keyway

Port Royal Deadbolt / Single Cylinder / Solid Brass

Part Number	Grade	Finish	List Price Each
PRDRSU3	Grade 2	US3	56.00
PRDRSU10B	Grade 2	US10B	56.00
PRDRSU15	Grade 2	US15	56.00
PRDRSU26	Grade 2	US26	56.00

Schlage C Keyway Compatible

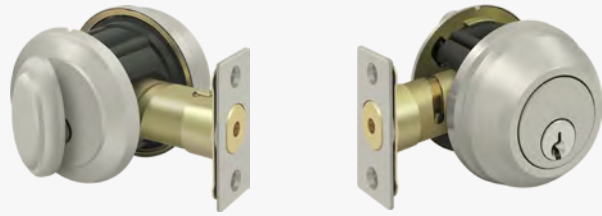
Modern Square Deadbolt / Single Cylinder / Zinc

Part Number	Grade	Finish	List Price Each
ZDSU3	Grade 2	US3	68.00
ZDSU10B	Grade 2	US10B	68.00
ZDSU15	Grade 2	US15	68.00
ZDSU26	Grade 2	US26	68.00

Schlage C Keyway Compatible

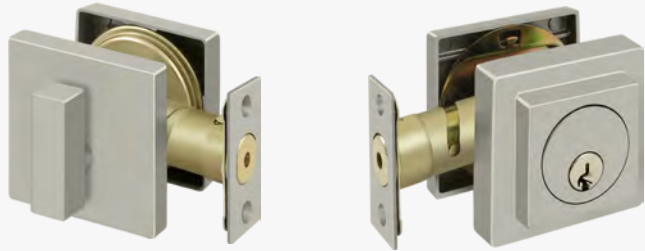
Modern Low Profile Deadbolt / Single Cylinder / Zinc

Part Number	Grade	Finish	List Price Each
ZDRU10B	Grade 3	US10B	72.00
ZDRU15	Grade 3	US15	72.00
ZDRU26	Grade 3	US26	72.00

Schlage C Keyway Compatible



A single cylinder deadbolt has a key cylinder on the outside and a thumb-turn on the inside

Levers / Elite Collection / Zinc

Portmore Lever / Privacy / R-Hand

PR	Part Number	Finish	List Price Each
<input type="checkbox"/>	ZPLR2U10B-RH	US10B	59.00
<input type="checkbox"/>	ZPLR2U15-RH	US15	59.00
<input type="checkbox"/>	ZPLR2U26-RH	US26	59.00

Portmore Lever / Passage

PA	Part Number	Finish	List Price Each
<input type="checkbox"/>	ZPLR3U10B	US10B	59.00
<input type="checkbox"/>	ZPLR3U15	US15	59.00
<input type="checkbox"/>	ZPLR3U26	US26	59.00

Portmore Lever / Privacy / L-Hand

PR	Part Number	Finish	List Price Each
<input type="checkbox"/>	ZPLR2U10B-LH	US10B	59.00
<input type="checkbox"/>	ZPLR2U15-LH	US15	59.00
<input type="checkbox"/>	ZPLR2U26-LH	US26	59.00

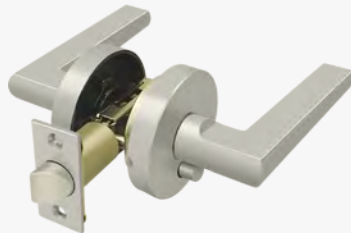
Portmore Lever / Dummy

DU	Part Number	Finish	List Price Each
<input type="checkbox"/>	ZPLR4U10B	US10B	29.00
<input type="checkbox"/>	ZPLR4U15	US15	29.00
<input type="checkbox"/>	ZPLR4U26	US26	29.00



- Auto-egress Privacy Function with thumb-push button on the inside and emergency release on the outside. Turning inside lever releases lock button automatically.

- PR** - Privacy Function
- PA** - Passage Function
- DU** - Dummy Function

Levers / Elite Collection / Zinc

Mandeville Lever / Privacy / R-Hand

PR	Part Number	Finish	List Price Each
<input type="checkbox"/>	ZMLR2U10B-RH	US10B	59.00
	ZMLR2U15-RH	US15	59.00
	ZMLR2U26-RH	US26	59.00

Mandeville Lever / Privacy / L-Hand

PR	Part Number	Finish	List Price Each
<input type="checkbox"/>	ZMLR2U10B-LH	US10B	59.00
	ZMLR2U15-LH	US15	59.00
	ZMLR2U26-LH	US26	59.00

Mandeville Lever / Passage

PA	Part Number	Finish	List Price Each
	ZMLR3U10B	US10B	59.00
	ZMLR3U15	US15	59.00
	ZMLR3U26	US26	59.00

Mandeville Lever / Dummy

DU	Part Number	Finish	List Price Each
	ZMLR4U10B	US10B	29.00
	ZMLR4U15	US15	29.00
	ZMLR4U26	US26	29.00



Auto-egress Privacy Function with thumb-push button on the inside and emergency release on the outside. Turning inside lever releases lock button automatically.

Livingston Lever / Privacy / R-Hand

PR	Part Number	Finish	List Price Each
<input type="checkbox"/>	ZLLS2U3-RH	US3	82.00
	ZLLS2U10B-RH	US10B	82.00
	ZLLS2U15-RH	US15	82.00
	ZLLS2U26-RH	US26	82.00

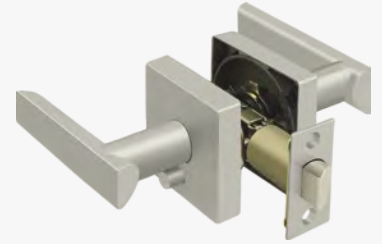
Livingston Lever / Privacy / L-Hand

PR	Part Number	Finish	List Price Each
<input type="checkbox"/>	ZLLS2U3-LH	US3	82.00
	ZLLS2U10B-LH	US10B	82.00
	ZLLS2U15-LH	US15	82.00
	ZLLS2U26-LH	US26	82.00

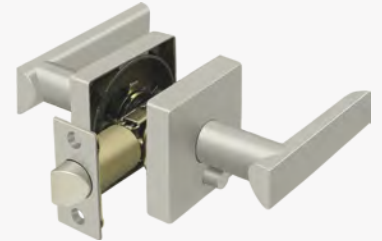
Livingston Lever / Passage

PA	Part Number	Finish	List Price Each
	ZLLS3U3	US3	82.00
	ZLLS3U10B	US10B	82.00
	ZLLS3U15	US15	82.00
	ZLLS3U26	US26	82.00

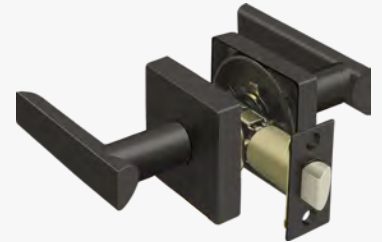
Livingston Lever / Dummy

DU	Part Number	Finish	List Price Each
	ZLLS4U3	US3	42.00
	ZLLS4U10B	US10B	42.00
	ZLLS4U15	US15	42.00
	ZLLS4U26	US26	42.00



Auto-egress Privacy Function with thumb-push button on the inside and emergency release on the outside. Turning inside lever releases lock button automatically.

- PR - Privacy Function
- PA - Passage Function
- DU - Dummy Function

elite collection

—displays available—



call now to order
1.800.665.2226

Handleset / Traditional Collection / Solid Brass

Montego Handleset / Entry

H	Part Number	Finish	List Price Each
	810871-5	US5	150.00
	810871-10B	US10B	150.00
	810871-15	US15	150.00
	810871-15A	US15A	150.00
	810871-26	US26	150.00
	810871-26D	US26D	150.00
	810871-003	CR003	170.00

Residential Grade 2 Deadbolt
Kwikset Keyway Compatible



Montego handleset / Dummy

HDU	Part Number	Finish	List Price Each
	810871D-5	US5	126.00
	810871D-10B	US10B	126.00
	810871D-15	US15	126.00
	810871D-15A	US15A	126.00
	810871D-26	US26	126.00
	810871D-26D	US26D	126.00
	810871D-003	CR003	153.00

H - Keyed Handleset
HDU - Dummy Handleset



Traditional Collection / Claremont Lever / Right Hand

Claremont Lever / Entry / R-Hand

E	Part Number	Finish	List Price Each
	5851-10B	US10B	31.00
	5851-15	US15	31.00
	5851-26	US26	31.00

Kwikset Keyway Compatible



Claremont Lever / Left Hand

Claremont Lever / Entry / L-Hand

E	Part Number	Finish	List Price Each
	5851L-10B	US10B	31.00
	5851L-15	US15	31.00
	5851L-26	US26	31.00

Kwikset Keyway Compatible



Claremont Lever / Privacy / R-Hand

PR	Part Number	Finish	List Price Each
<input type="checkbox"/>	5852-10B	US10B	30.00
	5852-15	US15	30.00
	5852-26	US26	30.00



Claremont Lever / Privacy / L-Hand

PR	Part Number	Finish	List Price Each
<input type="checkbox"/>	5852L-10B	US10B	30.00
	5852L-15	US15	30.00
	5852L-26	US26	30.00

Kwikset Keyway Compatible



Claremont Lever / Passage / R-Hand

PA	Part Number	Finish	List Price Each
	5853-10B	US10B	30.00
	5853-15	US15	30.00
	5853-26	US26	30.00



Claremont Lever / Passage / L-Hand

PA	Part Number	Finish	List Price Each
	5853L-10B	US10B	30.00
	5853L-15	US15	30.00
	5853L-26	US26	30.00

Kwikset Keyway Compatible



Claremont Lever / Dummy / R-Hand

DU	Part Number	Finish	List Price Each
	5854D-10B	US10B	16.80
	5854D-15	US15	16.80
	5854D-26	US26	16.80



Claremont Lever / Dummy / L-Hand

DU	Part Number	Finish	List Price Each
	5854LD-10B	US10B	16.80
	5854LD-15	US15	16.80
	5854LD-26	US26	16.80

Kwikset Keyway Compatible



Privacy Lever with finger-turn lock on the inside and emergency release on the outside.

Privacy Lever with finger-turn lock on the inside and emergency release on the outside.

E - Entry Function
PR - Privacy Function
PA - Passage Function
DU - Dummy Function

Trelawny Lever / Traditional Collection

Trelawny Lever / Entry / R-Hand

E	Part Number	Finish	List Price Each
	6861-5	US5	31.00
	6861-10B	US10B	31.00
	6861-15	US15	31.00
	6861-15A	US15A	31.00
	6861-26	US26	31.00
	6861-26D	US26D	31.00
	6861-003	CR003	33.00

Kwikset Keyway Compatible

Trelawny Lever / Entry / L-Hand

E	Part Number	Finish	List Price Each
	6861L-5	US5	31.00
	6861L-10B	US10B	31.00
	6861L-15	US15	31.00
	6861L-15A	US15A	31.00
	6861L-26	US26	31.00
	6861L-26D	US26D	31.00
	6861L-003	CR003	33.00

Kwikset Keyway Compatible

Trelawny Lever / Privacy / R-Hand

PR	Part Number	Finish	List Price Each
<input type="checkbox"/>	6862-5	US5	30.00
	6862-10B	US10B	30.00
	6862-15	US15	30.00
	6862-15A	US15A	30.00
	6862-26	US26	30.00
	6862-26D	US26D	30.00
	6862-003	CR003	32.50

Trelawny Lever / Privacy / L-Hand

PR	Part Number	Finish	List Price Each
<input type="checkbox"/>	6862L-5	US5	30.00
	6862L-10B	US10B	30.00
	6862L-15	US15	30.00
	6862L-15A	US15A	30.00
	6862L-26	US26	30.00
	6862L-26D	US26D	30.00
	6862L-003	CR003	32.50

Trelawny Lever / Passage / R-Hand

PA	Part Number	Finish	List Price Each
	6863-5	US5	30.00
	6863-10B	US10B	30.00
	6863-15	US15	30.00
	6863-15A	US15A	30.00
	6863-26	US26	30.00
	6863-26D	US26D	30.00
	6863-003	CR003	32.50

Trelawny Lever / Passage / L-Hand

PA	Part Number	Finish	List Price Each
	6863L-5	US5	30.00
	6863L-10B	US10B	30.00
	6863L-15	US15	30.00
	6863L-15A	US15A	30.00
	6863L-26	US26	30.00
	6863L-26D	US26D	30.00
	6863L-003	CR003	32.50

Trelawny Lever / Dummy / R-Hand

DU	Part Number	Finish	List Price Each
	6864D-5	US5	15.50
	6864D-10B	US10B	15.50
	6864D-15	US15	15.50
	6864D-15A	US15A	15.50
	6864D-26	US26	15.50
	6864D-26D	US26D	15.50
	6864D-003	CR003	16.00

Trelawny Lever / Dummy / L-Hand

DU	Part Number	Finish	List Price Each
	6864LD-5	US5	15.50
	6864LD-10B	US10B	15.50
	6864LD-15	US15	15.50
	6864LD-15A	US15A	15.50
	6864LD-26	US26	15.50
	6864LD-26D	US26D	15.50
	6864LD-003	CR003	16.00

Trelawny Lever / Trim Kit / R-Hand

TK	Part Number	Finish	List Price Each
	TK6861-5	US5	16.80
	TK6861-10B	US10B	16.80
	TK6861-15	US15	16.80
	TK6861-15A	US15A	16.80
	TK6861-26	US26	16.80
	TK6861-26D	US26D	16.80
	TK6861-003	CR003	17.20

Trim Kits are to be used with Traditional Collection Handlesets only and are sold separately.

Trelawny Lever / Trim Kit / L-Hand

TK	Part Number	Finish	List Price Each
	TK6861L-5	US5	16.80
	TK6861L-10B	US10B	16.80
	TK6861L-15	US15	16.80
	TK6861L-15A	US15A	16.80
	TK6861L-26	US26	16.80
	TK6861L-26D	US26D	16.80
	TK6861L-003	CR003	17.20

Trim Kits are to be used with Traditional Collection Handlesets only and are sold separately.

 Privacy Lever with finger-turn lock on the inside and emergency release on the outside.

 Privacy Lever with finger-turn lock on the inside and emergency release on the outside.

- E - Entry Function
- PR - Privacy Function
- PA - Passage Function
- DU - Dummy Function
- TK - Trim Kit Function

Savanna Lever / Traditional Collection

Savanna Lever / Entry / R-Hand

E	Part Number	Finish	List Price Each
	6461-5	US5	30.00
	6461-10B	US10B	30.00
	6461-15	US15	30.00
	6461-15A	US15A	30.00
	6461-26	US26	30.00
	6461-26D	US26D	30.00
	6461-003	CR003	32.50

Kwikset Keyway Compatible



Savanna Lever / Entry / L-Hand

E	Part Number	Finish	List Price Each
	6461L-5	US5	30.00
	6461L-10B	US10B	30.00
	6461L-15	US15	30.00
	6461L-15A	US15A	30.00
	6461L-26	US26	30.00
	6461L-26D	US26D	30.00
	6461L-003	CR003	32.50

Kwikset Keyway Compatible



Savanna Lever / Privacy / R-Hand

PR	Part Number	Finish	List Price Each
<input type="checkbox"/>	6462-5	US5	29.00
	6462-10B	US10B	29.00
	6462-15	US15	29.00
	6462-15A	US15A	29.00
	6462-26	US26	29.00
	6462-26D	US26D	29.00
	6462-003	CR003	31.50



Savanna Lever / Privacy / L-Hand

PR	Part Number	Finish	List Price Each
<input type="checkbox"/>	6462L-5	US5	29.00
	6462L-10B	US10B	29.00
	6462L-15	US15	29.00
	6462L-15A	US15A	29.00
	6462L-26	US26	29.00
	6462L-26D	US26D	29.00
	6462L-003	CR003	31.50



Savanna Lever / Passage / R-Hand

PA	Part Number	Finish	List Price Each
	6463-5	US5	29.00
	6463-10B	US10B	29.00
	6463-15	US15	29.00
	6463-15A	US15A	29.00
	6463-26	US26	29.00
	6463-26D	US26D	29.00
	6463-003	CR003	31.50



Savanna Lever / Passage / L-Hand

PA	Part Number	Finish	List Price Each
	6463L-5	US5	29.00
	6463L-10B	US10B	29.00
	6463L-15	US15	29.00
	6463L-15A	US15A	29.00
	6463L-26	US26	29.00
	6463L-26D	US26D	29.00
	6463L-003	CR003	31.50



Savanna Lever / Dummy / R-Hand

DU	Part Number	Finish	List Price Each
	6464D-5	US5	15.50
	6464D-10B	US10B	15.50
	6464D-15	US15	15.50
	6464D-15A	US15A	15.50
	6464D-26	US26	15.50
	6464D-26D	US26D	15.50
	6464D-003	CR003	16.00



Savanna Lever / Dummy / L-Hand

DU	Part Number	Finish	List Price Each
	6464LD-5	US5	15.50
	6464LD-10B	US10B	15.50
	6464LD-15	US15	15.50
	6464LD-15A	US15A	15.50
	6464LD-26	US26	15.50
	6464LD-26D	US26D	15.50
	6464LD-003	CR003	16.00



Savanna Lever / Trim Kit / R-Hand

TK	Part Number	Finish	List Price Each
	TK6461-5	US5	16.80
	TK6461-10B	US10B	16.80
	TK6461-15	US15	16.80
	TK6461-15A	US15A	16.80
	TK6461-26	US26	16.80
	TK6461-26D	US26D	16.80
	TK6461-003	CR003	17.20

Trim Kits are to be used with Traditional Collection Handlesets only and are sold separately.

 Privacy Lever with finger-turn lock on the inside and emergency release on the outside.

Savanna Lever / Trim Kit / L-Hand

TK	Part Number	Finish	List Price Each
	TK6461L-5	US5	16.80
	TK6461L-10B	US10B	16.80
	TK6461L-15	US15	16.80
	TK6461L-15A	US15A	16.80
	TK6461L-26	US26	16.80
	TK6461L-26D	US26D	16.80
	TK6461L-003	CR003	17.20

Trim Kits are to be used with Traditional Collection Handlesets only and are sold separately.

 Privacy Lever with finger-turn lock on the inside and emergency release on the outside.

E - Entry Function

PR - Privacy Function

PA - Passage Function

DU - Dummy Function

TK - Trim Kit Function

Manchester Lever / Traditional Collection

Linstead Lever / Traditional Collection

Manchester Lever / Entry

E	Part Number	Finish	List Price Each
	6201-5	US5	29.50
	6201-10B	US10B	29.50
	6201-15	US15	29.50
	6201-15A	US15A	29.50
	6201-26	US26	29.50
	6201-26D	US26D	29.50
	6201-003	CR003	32.00

Kwikset Keyway Compatible



Linstead Lever / Entry

E	Part Number	Finish	List Price Each
	6431-5	US5	30.00
	6431-10B	US10B	30.00
	6431-15	US15	30.00
	6431-15A	US15A	30.00
	6431-26	US26	30.00
	6431-26D	US26D	30.00
	6431-003	CR003	32.50

Kwikset Keyway Compatible



Manchester Lever / Privacy

PR	Part Number	Finish	List Price Each
<input type="checkbox"/>	6202-5	US5	28.50
	6202-10B	US10B	28.50
	6202-15	US15	28.50
	6202-15A	US15A	28.50
	6202-26	US26	28.50
	6202-26D	US26D	28.50
	6202-003	CR003	31.00



Linstead Lever / Privacy

PR	Part Number	Finish	List Price Each
<input type="checkbox"/>	6432-5	US5	29.00
	6432-10B	US10B	29.00
	6432-15	US15	29.00
	6432-15A	US15A	29.00
	6432-26	US26	29.00
	6432-26D	US26D	29.00
	6432-003	CR003	31.50



Manchester Lever / Passage

PA	Part Number	Finish	List Price Each
	6203-5	US5	28.50
	6203-10B	US10B	28.50
	6203-15	US15	28.50
	6203-15A	US15A	28.50
	6203-26	US26	28.50
	6203-26D	US26D	28.50
	6203-003	CR003	31.00



Linstead Lever / Passage

PA	Part Number	Finish	List Price Each
	6433-5	US5	29.00
	6433-10B	US10B	29.00
	6433-15	US15	29.00
	6433-15A	US15A	29.00
	6433-26	US26	29.00
	6433-26D	US26D	29.00
	6433-003	CR003	31.50

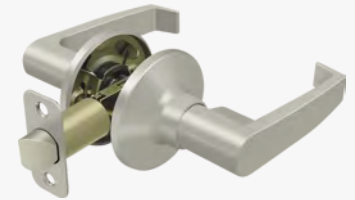

Manchester Lever / Dummy

DU	Part Number	Finish	List Price Each
	6204D-5	US5	15.50
	6204D-10B	US10B	15.50
	6204D-15	US15	15.50
	6204D-15A	US15A	15.50
	6204D-26	US26	15.50
	6204D-26D	US26D	15.50
	6204D-003	CR003	16.00



Linstead Lever / Dummy

DU	Part Number	Finish	List Price Each
	6434D-5	US5	15.50
	6434D-10B	US10B	15.50
	6434D-15	US15	15.50
	6434D-15A	US15A	15.50
	6434D-26	US26	15.50
	6434D-26D	US26D	15.50
	6434D-003	CR003	16.00

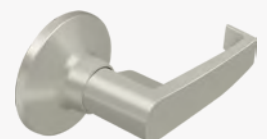

Manchester Lever / Trim Kit

TK	Part Number	Finish	List Price Each
	TK6201-5	US5	16.80
	TK6201-10B	US10B	16.80
	TK6201-15	US15	16.80
	TK6201-15A	US15A	16.80
	TK6201-26	US26	16.80
	TK6201-26D	US26D	16.80
	TK6201-003	CR003	17.20

Trim Kits are to be used with Traditional Collection Handlesets only and are sold separately.

- Privacy Lever with finger-turn lock on the inside and emergency release on the outside.



Linstead Lever / Trim Kit

TK	Part Number	Finish	List Price Each
	TK6431-5	US5	16.80
	TK6431-10B	US10B	16.80
	TK6431-15	US15	16.80
	TK6431-15A	US15A	16.80
	TK6431-26	US26	16.80
	TK6431-26D	US26D	16.80
	TK6431-003	CR003	17.20

Trim Kits are to be used with Traditional Collection Handlesets only and are sold separately.

- Privacy Lever with finger-turn lock on the inside and emergency release on the outside.



- E** - Entry Function
- PR** - Privacy Function
- PA** - Passage Function
- DU** - Dummy Function
- TK** - Trim Kit Function

Morant Lever / Traditional Collection

Portland Knob / Traditional Collection

Morant Lever / Entry

E	Part Number	Finish	List Price Each
	6411-5	US5	30.00
	6411-10B	US10B	30.00
	6411-15	US15	30.00
	6411-15A	US15A	30.00
	6411-26	US26	30.00
	6411-26D	US26D	30.00
	6411-003	CR003	32.50

Kwikset Keyway Compatible



Portland Knob / Entry

E	Part Number	Finish	List Price Each
	6901-5	US5	24.00
	6901-10B	US10B	24.00
	6901-15	US15	24.00
	6901-15A	US15A	24.00
	6901-26	US26	24.00
	6901-26D	US26D	24.00
	6901-003	CR003	27.50

Kwikset Keyway Compatible



Morant Lever / Privacy

PR	Part Number	Finish	List Price Each
<input type="checkbox"/>	6412-5	US5	29.00
	6412-10B	US10B	29.00
	6412-15	US15	29.00
	6412-15A	US15A	29.00
	6412-26	US26	29.00
	6412-26D	US26D	29.00
	6412-003	CR003	31.50



Portland Knob / Privacy

PR	Part Number	Finish	List Price Each
<input type="checkbox"/>	6902-5	US5	23.50
	6902-10B	US10B	23.50
	6902-15	US15	23.50
	6902-15A	US15A	23.50
	6902-26	US26	23.50
	6902-26D	US26D	23.50
	6902-003	CR003	26.60



Morant Lever / Passage

PA	Part Number	Finish	List Price Each
	6413-5	US5	29.00
	6413-10B	US10B	29.00
	6413-15	US15	29.00
	6413-15A	US15A	29.00
	6413-26	US26	29.00
	6413-26D	US26D	29.00
	6413-003	CR003	31.50



Portland Knob / Passage

PA	Part Number	Finish	List Price Each
	6903-5	US5	23.50
	6903-10B	US10B	23.50
	6903-15	US15	23.50
	6903-15A	US15A	23.50
	6903-26	US26	23.50
	6903-26D	US26D	23.50
	6903-003	CR003	26.60



Morant Lever / Dummy

DU	Part Number	Finish	List Price Each
	6414D-5	US5	15.50
	6414D-10B	US10B	15.50
	6414D-15	US15	15.50
	6414D-15A	US15A	15.50
	6414D-26	US26	15.50
	6414D-26D	US26D	15.50
	6414D-003	CR003	16.00



Portland Knob / Dummy

DU	Part Number	Finish	List Price Each
	6904D-5	US5	15.50
	6904D-10B	US10B	15.50
	6904D-15	US15	15.50
	6904D-15A	US15A	15.50
	6904D-26	US26	15.50
	6904D-26D	US26D	15.50
	6904D-003	CR003	16.00



Morant Lever / Trim Kit

TK	Part Number	Finish	List Price Each
	TK6411-5	US5	16.80
	TK6411-10B	US10B	16.80
	TK6411-15	US15	16.80
	TK6411-15A	US15A	16.80
	TK6411-26	US26	16.80
	TK6411-26D	US26D	16.80
	TK6411-003	CR003	17.20

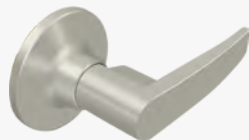

Portland Knob / Trim Kit

TK	Part Number	Finish	List Price Each
	TK6901-5	US5	16.80
	TK6901-10B	US10B	16.80
	TK6901-15	US15	16.80
	TK6901-15A	US15A	16.80
	TK6901-26	US26	16.80
	TK6901-26D	US26D	16.80
	TK6901-003	CR003	17.20



Trim Kits are to be used with Traditional Collection Handlesets only and are sold separately.

 Privacy Lever with finger-turn lock on the inside and emergency release on the outside.

Trim Kits are to be used with Traditional Collection Handlesets only and are sold separately.

 Privacy Knob with finger-turn lock on the inside and emergency release on the outside.

- E** - Entry Function
- PR** - Privacy Function
- PA** - Passage Function
- DU** - Dummy Function
- TK** - Trim Kit Function

Round Knob / Traditional Collection

Egg Knob / Traditional Collection

Round Knob / Entry

E	Part Number	Finish	List Price Each
	6171-5	US5	24.00
	6171-10B	US10B	24.00
	6171-15	US15	24.00
	6171-15A	US15A	24.00
	6171-26	US26	24.00
	6171-26D	US26D	24.00
	6171-003	CR003	27.50

Kwikset Keyway Compatible



Round Knob / Privacy

PR	Part Number	Finish	List Price Each
<input type="checkbox"/>	6172-5	US5	23.50
	6172-10B	US10B	23.50
	6172-15	US15	23.50
	6172-15A	US15A	23.50
	6172-26	US26	23.50
	6172-26D	US26D	23.50
	6172-003	CR003	26.60



Round Knob / Passage

PA	Part Number	Finish	List Price Each
	6173-5	US5	23.50
	6173-10B	US10B	23.50
	6173-15	US15	23.50
	6173-15A	US15A	23.50
	6173-26	US26	23.50
	6173-26D	US26D	23.50
	6173-003	CR003	26.60



Round Knob / Dummy

DU	Part Number	Finish	List Price Each
	6174D-5	US5	15.50
	6174D-10B	US10B	15.50
	6174D-15	US15	15.50
	6174D-15A	US15A	15.50
	6174D-26	US26	15.50
	6174D-26D	US26D	15.50
	6174D-003	CR003	16.00



Privacy Knob with Finger-turn lock on the inside and emergency release on the outside.

Egg Knob / Entry

E	Part Number	Finish	List Price Each
	3381-5	US5	36.08
	3381-10B	US10B	36.08
	3381-15	US15	36.08
	3381-15A	US15A	36.08
	3381-26	US26	36.08
	3381-26D	US26D	36.08
	3381-003	CR003	38.28

Kwikset Keyway Compatible

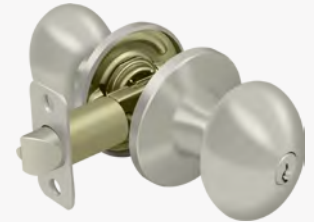

Egg Knob / Privacy

PR	Part Number	Finish	List Price Each
<input type="checkbox"/>	3382-5	US5	33.88
	3382-10B	US10B	33.88
	3382-15	US15	33.88
	3382-15A	US15A	33.88
	3382-26	US26	33.88
	3382-26D	US26D	33.88
	3382-003	CR003	38.28

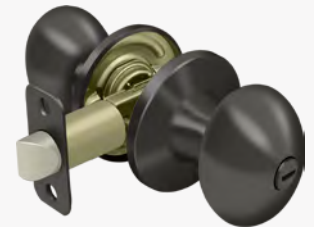

Egg Knob / Passage

PA	Part Number	Finish	List Price Each
	3383-5	US5	31.68
	3383-10B	US10B	31.68
	3383-15	US15	31.68
	3383-15A	US15A	31.68
	3383-26	US26	31.68
	3383-26D	US26D	31.68
	3383-003	CR003	33.88

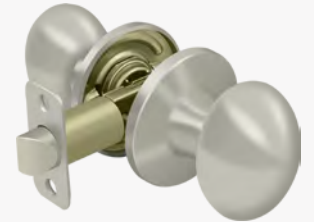

Egg Knob / Dummy

DU	Part Number	Finish	List Price Each
	3384D-5	US5	15.50
	3384D-10B	US10B	15.50
	3384D-15	US15	15.50
	3384D-15A	US15A	15.50
	3384D-26	US26	15.50
	3384D-26D	US26D	15.50
	3384D-003	CR003	16.00



Linstead Lever / Trim Kit

TK	Part Number	Finish	List Price Each
	TK3381-5	US5	16.80
	TK3381-10B	US10B	16.80
	TK3381-15	US15	16.80
	TK3381-15A	US15A	16.80
	TK3381-26	US26	16.80
	TK3381-26D	US26D	16.80
	TK3381-003	CR003	17.20

Trim Kits are to be used with Traditional Collection Handlesets only and are sold separately.



Privacy Knob with finger-turn lock on the inside and emergency release on the outside.

- E** - Entry Function
- PR** - Privacy Function
- PA** - Passage Function
- DU** - Dummy Function
- TK** - Trim Kit Function

St. Thomas Knob / Traditional Collection

Replacement Door Knobs

St. Thomas Knob / Entry

E	Part Number	Finish	List Price Each
	6111-3	US3	22.50
	6111-5	US5	22.50
	611126D	US26D	22.50

Kwikset Keyway Compatible

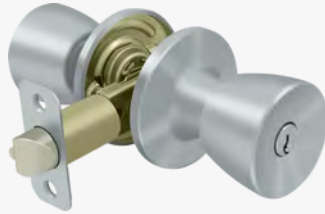

St. Thomas Knob / Privacy

PR	Part Number	Finish	List Price Each
<input type="checkbox"/>	6112-3	US3	21.50
	6112-5	US5	21.50
	6112-26D	US26D	21.50

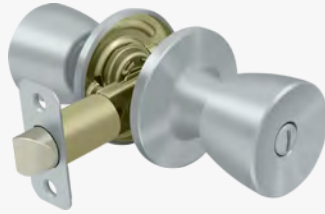

St. Thomas Knob / Passage

PA	Part Number	Finish	List Price Each
<input type="checkbox"/>	6113-3	US3	21.50
	6113-5	US5	21.50
	6113-26D	US26D	21.50

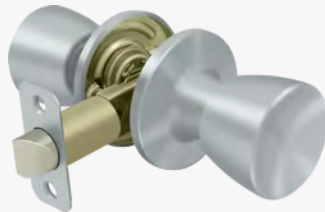

Privacy Knob with finger-turn lock on the inside and emergency release on the outside.

Replacement Door Knobs / Solid Brass

Part Number	Finish	List Price Each
DKR20U3	US3	14.00

- 2 1/4" Diameter Knobs
- 1/4" Square Spindle
- 4 Set screws included



- E** - Entry Function
- PR** - Privacy Function
- PA** - Passage Function

Deadbolts / Traditional Collection

Deadbolt / Grade 3 / Single Cylinder

Part Number	Finish	List Price Each
7301KA2-3	US3	35.00
7301KA2-5	US5	35.00
7301KA2-10B	US10B	35.00
7301KA2-15	US15	35.00
7301KA2-15A	US15A	35.00
7301KA2-26	US26	35.00
7301KA2-26D	US26D	35.00
7301KA2-32D	US32D	38.00
7301KA2-003	CR003	42.00

Kwikset Keyway Compatible

US32D = Stainless Steel 304



A single cylinder deadbolt has a key cylinder on the outside and a thumb-turn lock on the inside.

Deadbolt / Grade 3 / Double Cylinder

Part Number	Finish	List Price Each
7312KA2-3	US3	48.00
7312KA2-5	US5	48.00
7312KA2-10B	US10B	48.00
7312KA2-15	US15	48.00
7312KA2-15A	US15A	48.00
7312KA2-26	US26	48.00
7312KA2-26D	US26D	48.00

Kwikset Keyway Compatible



A double cylinder deadbolt has a key lock on both sides.

Latches for Traditional Collection

Cylinders for Traditional Collection

Drive-in Latches / Entry

E	Part Number	Finish	List Price Each
	DLE23875U5	US5	5.50
	DLE23875U10B	US10B	5.50
	DLE23875U15	US15	5.50
	DLE23875U15A	US15A	5.50
	DLE23875U26	US26	5.50
	DLE23875U26D	US26D	5.50
	DLE23875CR003	CR003	5.50

Adjustable from 2-3/8"~ 2-3/4"



Drive-In Latches / Privacy & Passage

PR	Part Number	Finish	List Price Each
PA	DLP23875U5	US5	5.50
	DLP23875U10B	US10B	5.50
	DLP23875U15	US15	5.50
	DLP23875U15A	US15A	5.50
	DLP23875U26	US26	5.50
	DLP23875U26D	US26D	5.50
	DLP23875CR003	CR003	5.50

Adjustable from 2-3/8"~ 2-3/4"



Square Latches / Entry

E	Part Number	Finish	List Price Each
	SLE23875U3	US3	5.50
	SLE23875U5	US5	5.50
	SLE23875U10B	US10B	5.50
	SLE23875U15	US15	5.50
	SLE23875U15A	US15A	5.50
	SLE23875U26	US26	5.50
	SLE23875U26D	US26D	5.50
	SLE23875CR003	CR003	5.50

Adjustable from 2-3/8"~ 2-3/4"



Square Latches / Privacy & Passage

PR	Part Number	Finish	List Price Each
PA	SLP23875U5	US5	5.50
	SLP23875U10B	US10B	5.50
	SLP23875U15	US15	5.50
	SLP23875U15A	US15A	5.50
	SLP23875U26	US26	5.50
	SLP23875U26D	US26D	5.50
	SLP23875CR003	CR003	5.50

Adjustable from 2-3/8"~ 2-3/4"



Cylinders for Traditional Collection Knobs

Part Number	Finish	List Price Each
CYLK-5	US5	5.00
CYLK-10B	US10B	5.00
CYLK-15	US15	5.00
CYLK-26D	US26D	5.00
CYLK-003	CR003	5.00

Kwikset Keyway Compatible



Cylinders for Traditional Collection Levers

Part Number	Finish	List Price Each
CYLL-5	US5	5.00
CYLL-10B	US10B	5.00
CYLL-15	US15	5.00
CYLL-26D	US26D	5.00
CYLL-003	CR003	5.00

Kwikset Keyway Compatible



Latch for Traditional Collection Deadbolts

Part Number	Finish	List Price Each
RLD23875U5	US5	5.30
RLD23875U10B	US10B	5.30
RLD23875U15	US15	5.30
RLD23875U15A	US15A	5.30
RLD23875U26	US26	5.30
RLD23875U26D	US26D	5.30
RLD23875CR003	CR003	5.30

Adjustable from 2-3/8"~ 2-3/4"



- E - Entry Function
- PR - Privacy Function
- PA - Passage Function